

## Table of Contents

<b>Introduction</b>	<b>4</b>
<b>Instrument Cluster</b>	<b>10</b>
Warning and control lights	10
Gauges	13
<b>Entertainment Systems</b>	<b>15</b>
AM/FM stereo cassette with CD	15
AM/FM stereo cassette	17
AM/FM stereo with CD	24
<b>Climate Controls</b>	<b>50</b>
Heater only	50
Manual heating and air conditioning	51
<b>Lights</b>	<b>53</b>
Headlamps	53
Turn signal control	54
Bulb replacement	55
<b>Driver Controls</b>	<b>61</b>
Windshield wiper/washer control	61
Power windows	66
Mirrors	66
Speed control (Cruise control)	67
<b>Locks and Security</b>	<b>71</b>
Keys	71
Locks	71

## Table of Contents

<b>Seating and Safety Restraints</b>	<b>75</b>
Seating	75
Safety restraints	80
Air bags	91
Child restraints	95
<b>Driving</b>	<b>111</b>
Starting	111
Brakes	114
Transmission operation	117
Trailer towing	124
<b>Roadside Emergencies</b>	<b>137</b>
Getting roadside assistance	137
Hazard flasher switch	138
Fuel pump shut-off switch	139
Fuses and relays	140
Changing tires	147
Jump starting	155
Wrecker towing	160
<b>Customer Assistance</b>	<b>161</b>
Reporting safety defects (U.S. only)	169
<b>Cleaning</b>	<b>170</b>
Underbody preservation	174

## Table of Contents

<b>Maintenance and Specifications</b>	<b>176</b>
Engine compartment	177
Engine oil	179
Battery	182
Fuel information	194
Air filter(s)	206
Part numbers	212
Refill capacities	213
Lubricant specifications	217
<b>Accessories</b>	<b>224</b>
<b>Index</b>	<b>227</b>

All rights reserved. Reproduction by any means, electronic or mechanical including photocopying, recording or by any information storage and retrieval system or translation in whole or part is not permitted without written authorization from Ford Motor Company. Ford may change the contents without notice and without incurring obligation.

Copyright © 2002 Ford Motor Company

## Introduction

### CALIFORNIA Proposition 65 Warning



**WARNING:** Engine exhaust, some of its constituents, and certain vehicle components contain or emit chemicals known to the State of California to cause cancer and birth defects or other reproductive harm. In addition, certain fluids contained in vehicles and certain products of component wear contain or emit chemicals known to the State of California to cause cancer and birth defects or other reproductive harm.

### CONGRATULATIONS

Congratulations on acquiring your new Ford. Please take the time to get well acquainted with your vehicle by reading this handbook. The more you know and understand about your vehicle the greater the safety and pleasure you will derive from driving it.

For more information on Ford Motor Company and its products visit the following website:

- In the United States: [www.ford.com](http://www.ford.com)
- In Canada: [www.ford.ca](http://www.ford.ca)
- In Australia: [www.ford.com.au](http://www.ford.com.au)
- In Mexico: [www.ford.com.mx](http://www.ford.com.mx)

Additional owner information is given in separate publications.

This Owner's Guide describes every option and model variant available and therefore some of the items covered may not apply to your particular vehicle. Furthermore, due to printing cycles it may describe options before they are generally available.

Remember to pass on the Owner's Guide when reselling the vehicle. It is an integral part of the vehicle.



**Fuel pump shut-off switch** In the event of an accident the safety switch will automatically cut off the fuel supply to the engine. The switch can also be activated through sudden vibration (e.g. collision when parking). To reset the switch, refer to the *Fuel pump shut-off switch* in the *Roadside emergencies* chapter.

### SAFETY AND ENVIRONMENT PROTECTION



#### Warning symbols in this guide

How can you reduce the risk of personal injury and prevent possible damage to others, your vehicle and its equipment? In this guide, answers

## Introduction

to such questions are contained in comments highlighted by the warning triangle symbol. These comments should be read and observed.

### **Warning symbols on your vehicle**

When you see this symbol, it is imperative that you consult the relevant section of this guide before touching or attempting adjustment of any kind.



### **Protecting the environment**

We must all play our part in protecting the environment. Correct vehicle usage and the authorized disposal of waste cleaning and lubrication materials are significant steps towards this aim. Information in this respect is highlighted in this guide with the tree symbol.



### **BREAKING-IN YOUR VEHICLE**

There are no particular guidelines for breaking-in your vehicle. During the first 1,600 km (1,000 miles) of driving, vary speeds frequently. This is recommended to give the moving parts a chance to break in.

### **SPECIAL NOTICES**

#### **Emission warranty**

The New Vehicle Limited Warranty includes Bumper-to-Bumper Coverage, Safety Restraint Coverage, Corrosion Coverage, and 7.3L Power Stroke Diesel Engine Coverage. In addition, your vehicle is eligible for Emissions Defect and Emissions Performance Warranties. For a detailed description of what is covered and what is not covered, refer to the *Warranty Guide* that is provided to you along with your Owner's Guide.

#### **Event Data Recorder**

The computer in your vehicle is capable of recording detailed data potentially including but not limited to information such as:

- the use of restraint systems including seat belts by the driver and passengers,
- information about the performance of various systems and modules in the vehicle, and

## Introduction

- information related to engine, throttle, steering, brake or other system status potentially including information related to how the driver operates the vehicle including but not limited to vehicle speed.

This information may be stored during regular operation or in a crash or near crash event. This stored information may be read out and used by:

- Ford Motor Company.
- service and repair facilities.
- law enforcement or government agencies.
- others who may assert a right or obtain your consent to know such information.

### Special instructions

For your added safety, your vehicle is fitted with sophisticated electronic controls.



Please read the section *Air bag* in the *Seating and safety restraints* chapter. Failure to follow the specific warnings and instructions could result in personal injury.



Front seat mounted rear facing child or infant seats should **NEVER** be used in front of a passenger side air bag unless the air bag can be and is turned OFF.

### Notice to owners of diesel-powered vehicles

Read the 7.3 Liter Power Stroke Direct Injection Turbo Diesel Owner's Guide Supplement for information regarding correct operation and maintenance of your diesel-powered light truck.

### Notice to owners of pickup trucks and utility type vehicles



Utility vehicles have a significantly higher rollover rate than other types of vehicles.

Before you drive your vehicle, please read this Owner's Guide carefully. Your vehicle is not a passenger car. As with other vehicles of this type, failure to operate this vehicle correctly may result in loss of vehicle control, vehicle rollover, personal injury or death.

### Using your vehicle as an ambulance

If your light truck is equipped with the Ford Ambulance Preparation Package, it may be utilized as an ambulance. Ford urges ambulance

## Introduction

manufacturers to follow the recommendations of the *Ford Incomplete Vehicle Manual*, *Ford Truck Body Builder's Layout Book* and the *QVM guidelines* as well as pertinent supplements. For additional information, please contact the Truck Body Builders Advisory Service 1-877-840-4338.

Use of your Ford light truck as an ambulance, without the Ford Ambulance Preparation Package voids the Ford New Vehicle Limited Warranty and may void the Emissions Warranties. In addition, ambulance usage without the preparation package could cause high underbody temperatures, overpressurized fuel and a risk of spraying fuel which could lead to fires.

If your vehicle is equipped with the Ford Ambulance Preparation Package, it will be indicated on the Certification label. The label is located on the driver's side door pillar or on the rear edge of the driver's door. You can determine whether the ambulance manufacturer followed Ford's recommendations by directly contacting that manufacturer. Ford Ambulance Preparation Package is only available on certain 7.3L Diesel engine equipped vehicles.

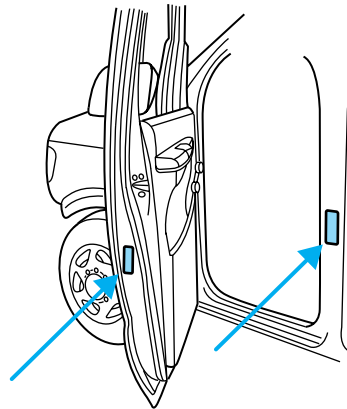

### Notice to owners of natural gas fueled vehicles

Before you drive your vehicle, be sure to read the *Dedicated Natural Gas Vehicle* supplement. This book contains important operation and maintenance information.

### Middle East/North Africa vehicle specific information

For your particular global region, your vehicle may be equipped with features and options that are different from the ones that are described in this Owner Guide; therefore, a supplement has been supplied that complements this book. By referring to the pages in the provided supplement, you can properly identify those features, recommendations and specifications that are unique to your vehicle. **Refer to this Owner Guide for all other required information and warnings.**

## Introduction





















These are some of the symbols you may see on your vehicle.

### Vehicle Symbol Glossary

Safety Alert		See Owner's Guide	
Fasten Safety Belt		Air Bag-Front	
Air Bag-Side		Child Seat	
Child Seat Installation Warning		Child Seat Lower Anchor	
Child Seat Tether Anchor		Brake System	
Anti-Lock Brake System		Brake Fluid - Non-Petroleum Based	
Traction Control		AdvanceTrac	
Master Lighting Switch		Hazard Warning Flasher	
Fog Lamps-Front		Fuse Compartment	
Fuel Pump Reset		Windshield Wash/Wipe	
Windshield Defrost/Demist		Rear Window Defrost/Demist	



Vehicle Symbol Glossary

Power Windows Front/Rear		Power Window Lockout	
Child Safety Door Lock/Unlock		Interior Luggage Compartment Release Symbol	
Panic Alarm		Engine Oil	
Engine Coolant		Engine Coolant Temperature	
Do Not Open When Hot		Battery	
Avoid Smoking, Flames, or Sparks		Battery Acid	
Explosive Gas		Fan Warning	
Power Steering Fluid		Maintain Correct Fluid Level	
Emission System		Engine Air Filter	
Passenger Compartment Air Filter		Jack	
Check fuel cap		Low tire warning	

## Instrument Cluster

### WARNING LIGHTS AND CHIMES

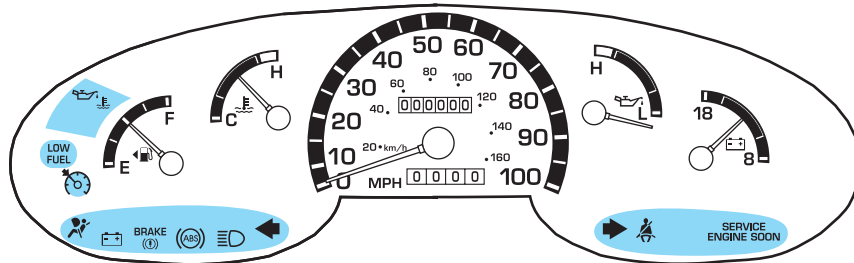

Warning lights and gauges can alert you to a vehicle condition that may become serious enough to cause expensive repairs. A warning light may illuminate when a problem exists with one of your vehicle's functions. Many lights will illuminate when you start your vehicle to make sure the bulb works. If any light remains on after starting the vehicle, have the respective system inspected immediately.

**Service engine soon:** If this light illuminates while driving, it is a possible indication that one of the engine's emission control systems has failed.

SERVICE  
ENGINE  
SOON

**Brake system warning light:** To confirm the brake system warning light is functional, it will momentarily illuminate when the ignition is turned to the ON position when the engine is not running, or in a position between ON and START, or by applying the parking brake when the ignition is turned to the ON position. If the brake system warning light does not illuminate at this time, seek service immediately from your dealership. Illumination after releasing the parking brake indicates low brake fluid level and the brake system should be inspected immediately by your servicing dealership.

BRAKE  
(!)

 Driving a vehicle with the brake system warning light on is dangerous. A significant decrease in braking performance may occur. It will take you longer to stop the vehicle. Have the vehicle checked by your dealer immediately.

## Instrument Cluster

**Brake reserve system warning (if equipped):** Illuminates to indicate normal Hydromax booster reserve system activation when the engine is OFF and the service brake pedal is applied.



This light may also illuminate momentarily if the engine is running and the driver turns the steering wheel fully in one direction while braking.

If the light remains on while the engine is running, this indicates inadequate hydraulic booster pressure or reserve pump system failure. Stop the vehicle safely as soon as possible and seek service immediately.

**Anti-lock brake system:** If the ABS light stays illuminated or continues to flash, a malfunction has been detected, have the system serviced immediately. Normal braking is still functional unless the brake warning light also is illuminated.

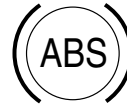

**Air bag readiness:** If this light fails to illuminate when ignition is turned to ON, continues to flash or remains on, have the system serviced immediately. A chime will also sound when a malfunction in the supplemental restraint system has been detected.



**Safety belt:** Reminds you to fasten your safety belt. A chime will also sound to remind you to fasten your safety belt.



**Charging system:** Illuminates when the battery is not charging properly.



**Low fuel:** Illuminates when the fuel level in the fuel tank is at, or near empty (refer to *Fuel gauge* in this chapter).



## Instrument Cluster

### **Speed control (if equipped):**

Illuminates when the speed control is activated. Turns off when the speed control system is deactivated.

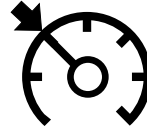

### **Oil pressure/Engine coolant:**

Illuminates when any of the following conditions has occurred:

- The engine coolant temperature is high.
- The engine oil pressure is low.

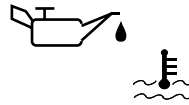

### **Transmission control indicator light (TCIL):**

Illuminates when the overdrive function of the transmission has been turned off, refer to the *Driving* chapter. If the light flashes steadily, have the system serviced immediately.

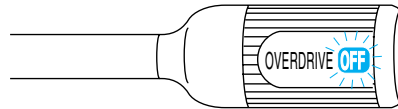

**Turn signal:** Illuminates when the left or right turn signal or the hazard lights are turned on. If the indicators stay on or flash faster, check for a burned out bulb.



**High beams:** Illuminates when the high beam headlamps are turned on.



**Key-in-ignition warning chime:** Sounds when the key is left in the ignition in the OFF/LOCK or ACC position and the driver's door is opened.

**Headlamps on warning chime:** Sounds when the headlamps or parking lamps are on, the ignition is off (and the key is not in the ignition) and the driver's door is opened.

## Instrument Cluster

### GAUGES

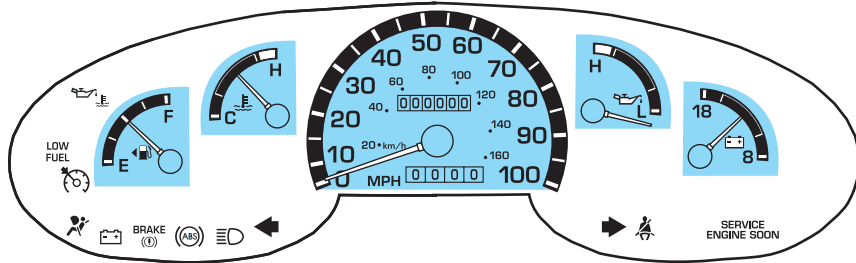

**Speedometer:** Indicates the current vehicle speed.

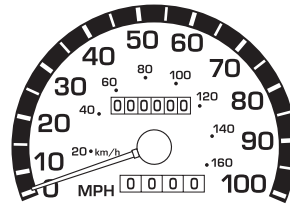

**Engine coolant temperature gauge:** Indicates engine coolant temperature. At normal operating temperature, the needle will be in the normal range (between “H” and “C”). **If it enters the red section, the engine is overheating. Stop the vehicle as soon as safely possible, switch off the engine and let the engine cool.**

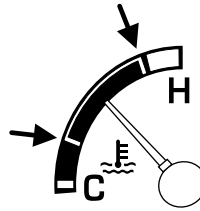

Never remove the coolant reservoir cap while the engine is running or hot.

## Instrument Cluster

**Odometer:** Registers the total kilometers (miles) of the vehicle.

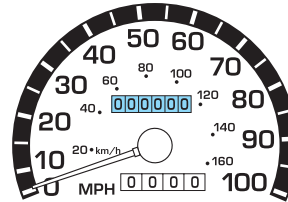

**Trip odometer:** Registers the kilometers (miles) of individual journeys. To reset, depress the control.

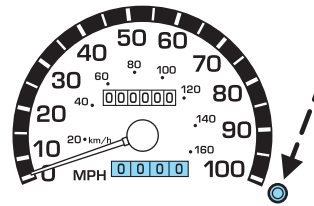

**Battery voltage gauge:** Indicates the battery voltage when the ignition is in the ON position. If the pointer moves and stays outside the normal operating range (as indicated by arrows), have the vehicle's electrical system checked as soon as possible.

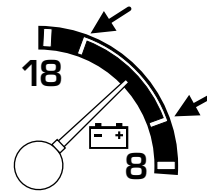

**Engine oil pressure gauge:** Indicates engine oil pressure. The needle should stay in the normal operating range (between "L" and "H"). If the needle falls below the normal range, stop the vehicle, turn off the engine and check the engine oil level. Add oil if needed. If the oil level is correct, have your vehicle checked at your dealership or by a qualified technician.

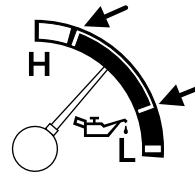

**Fuel gauge:** Indicates approximately how much fuel is left in the fuel tank (when the ignition is in the ON position).

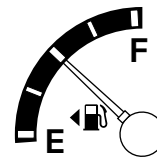

# Entertainment Systems

## AM/FM STEREO

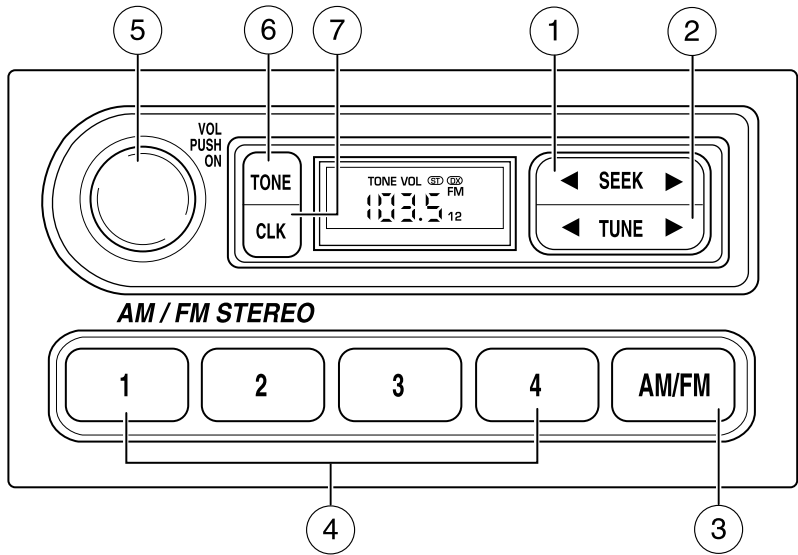

1. **Seek:** Press ◀ / ▶ to find the next listenable station down/up the frequency band.



2. **Tune:** Press ◀ / ▶ to manually adjust the radio frequency down/up.



3. **AM/FM:** Press to choose a frequency band in radio mode.



4. **Memory preset buttons:** To set a station: Select frequency band AM/FM1/FM2; tune to a station, press and hold a preset button until sound returns.



## Entertainment Systems

5. **Power/volume:** Press to turn ON/OFF; turn to increase or decrease volume levels.

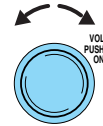

6. **Tone:** Press TONE until the desired level — Bass, Treble, Fade appears on the display. Turn the volume control to raise/lower the levels, or to move the audio sound from the right to left or the front to back (if equipped).

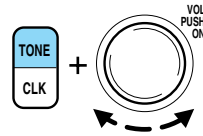

7. **CLK (Clock):** To set the hour, press and hold CLK until CLOCK SET appears in the display. Press SEEK to decrease ◀ or increase ▶ the hours.



To set the minute, press and hold CLK until CLOCK SET appears in the display. Press TUNE to decrease ◀ or increase ▶ the minutes.



# Entertainment Systems

## AM/FM STEREO CASSETTE

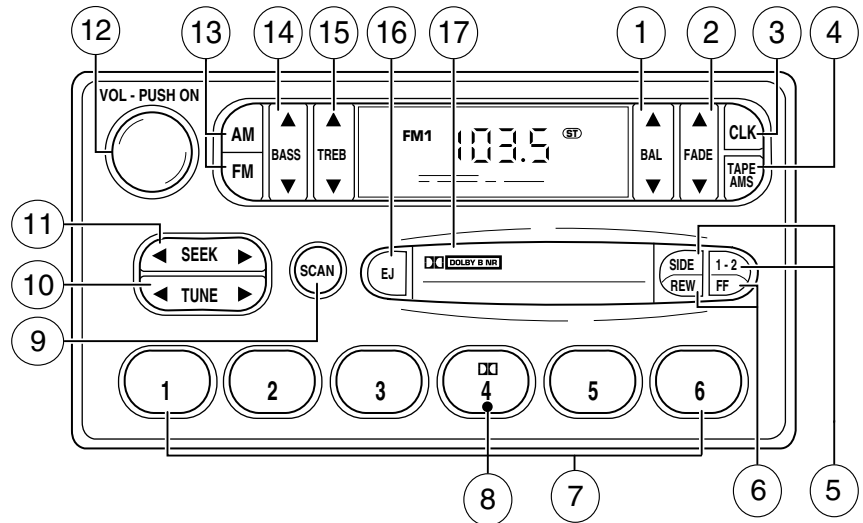

1. **Balance:** Press to shift sound to the left/right speakers.



2. **Fade:** Press to shift sound to the rear/front speakers.



3. **CLK:** To set the hour, press and hold CLK. Then press SEEK to decrease ◀ or increase ▶ the hours.



To set the minute, press and hold CLK and press TUNE to decrease ◀ or increase ▶ the minutes.

## Entertainment Systems

4. **Tape AMS:** In tape mode, press and hold to activate Automatic Music Search (allows you to quickly locate the beginning of the tape selection being played or to skip to the next selection). Then, press REW (for the beginning of the current selection) or FF (to advance to the next selection). The tape **MUST** have a blank section of at least four seconds duration between programs.



5. **Side 1-2:** Press to change tape direction.

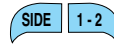

6. **REW (rewind):** Press to rewind the tape.



**FF (fast forward):** Press to advance the tape.



7. **Memory preset buttons:** To set a station: Select frequency band AM/FM1/FM2; tune to a station, press and hold a preset button until sound returns.



8. **Dolby® noise reduction:** Works in tape mode only. Reduces tape noise and hiss; press to activate/deactivate.

9. **Scan:** Press SCAN to hear a brief sampling of all listenable radio stations or all tape selections. Press again to stop.



10. **Tune:** Works in radio mode only. Press TUNE ◀/▶ to change frequency down/up



## Entertainment Systems

11. **Seek:** Press and release ◀ / ▶ for previous/next strong station, selection or track.



12. **Power/volume:** Press to turn ON/OFF; turn to increase or decrease volume levels.

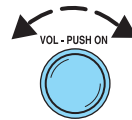

13. **AM/FM:** Press to choose a frequency band in radio mode.



14. **Bass:** Press ▼ / ▲ to decrease/increase the bass output.



15. **Treble:** Press ▼ / ▲ to decrease/increase the treble output.



16. **EJ (Eject):** Press to eject a tape.



17. **Cassette door:** Insert a cassette into the cassette door.

## Entertainment Systems

### PREMIUM AM/FM STEREO/CASSETTE/SINGLE CD

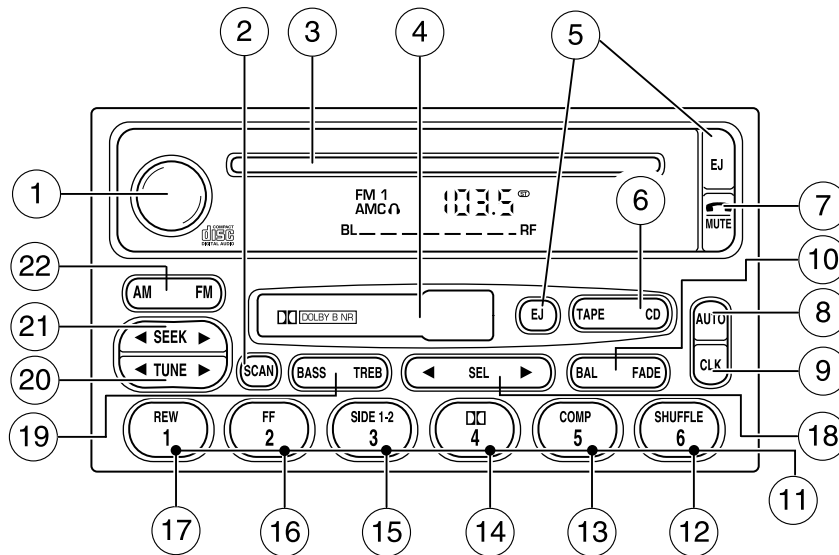

1. **Power/volume:** Press to turn ON/OFF; turn to increase/decrease volume.

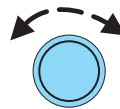

2. **Scan:** Press to hear a brief sampling of all listenable stations, tape selections or CD tracks. Press again to stop.



3. **CD Door:** Insert a CD with the label side up.

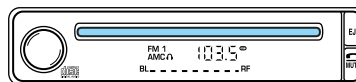

## Entertainment Systems

4. **Cassette door:** Insert the cassette with the opening to the right.

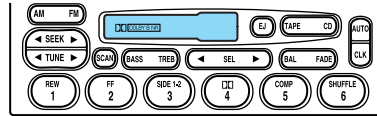

5. **Eject:** Press to eject the cassette/CD. The radio will resume playing.

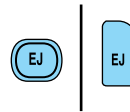

6. **Tape:** Press to start tape play. Press to stop tape during rewind/fast forward.



**CD:** Press to start CD play. With the dual media audio, press CD to toggle between single CD and CD changer play (if equipped).



7. **Mute:** Press to MUTE playing media; press again return to playing media.



8. **Auto:** Press to set first six strongest stations (if available) into AM, FM1 or FM2 memory buttons; press again to return to normal stations.



9. **Clock:** Press and hold to set the clock. Press the ◀ SEEK to decrease hours or SEEK ▶ to increase hours. Press the ◀ TUNE to decrease minutes or TUNE ▶ to increase minutes. If your vehicle has a stand alone clock this control will not function.



## Entertainment Systems

10. **Balance:** Press BAL; then press SEL ◀ / ▶ to shift sound to the left/right speakers.

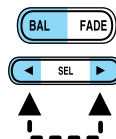

**Fade:** Press FADE; then press SEL ◀ / ▶ to shift sound to the rear/front speakers.

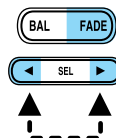

11. **Memory preset buttons:** To set a station: Select frequency band AM/FM, tune to a station, press and hold a preset button until sound returns.

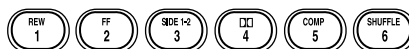

12. **Shuffle (CD):** Press to play tracks in random order.



13. **Compression (CD):** Press to bring soft and loud passages together for a more consistent listening level.



14. **Dolby® noise reduction:** Works in tape mode only. Reduces tape noise and hiss; press to activate/deactivate.



15. **Side 1-2:** Works in tape mode only. Press to play reverse side of the tape.



16. **Fast Forward (FF):** Press for a slow advance, press and hold for a fast advance.



## Entertainment Systems

17. **Rewind (REW):** Press for a slow rewind, press and hold for a fast rewind.



18. **Select (SEL):** Use with Bass, Treble, Balance and Fade controls.

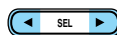

19. **Bass:** Press BASS; then press SEL ◀ / ▶ to decrease/increase the bass output.

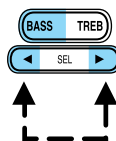

**Treble:** Press TREB; then press SEL ◀ / ▶ to decrease/increase the treble output.

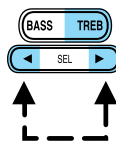

20. **Tune:** Works in radio mode only. Press TUNE ◀ / ▶ to change frequency down/up.

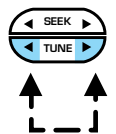

21. **Seek:** Press and release SEEK ◀ / ▶ for previous/next strong station, selection or track.

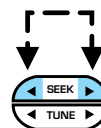

22. **AM/FM:** Press to select AM/FM1/FM2 frequency band.



## Entertainment Systems

### PREMIUM IN-DASH SIX CD SOUND SYSTEM

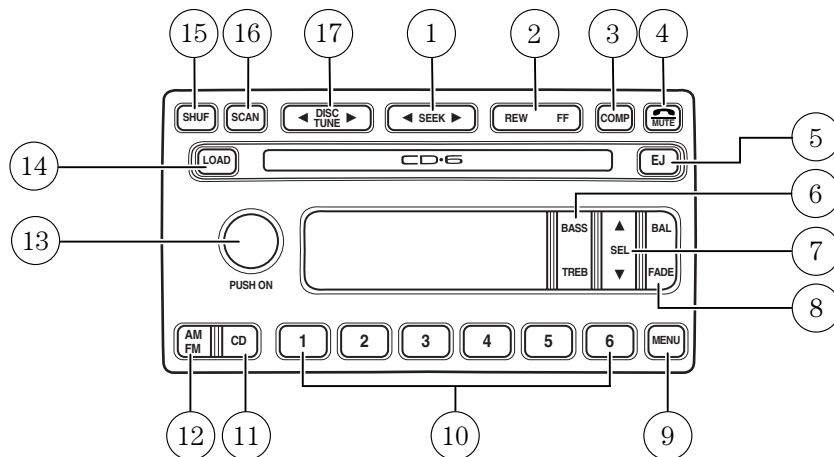

1. **Seek:** Press and release SEEK ◀ / ▶ for previous/next strong station, or track of the current disc.



2. **Rewind:** Press and hold until the desired selection is reached.



**Fast forward:** Press and hold until the desired selection is reached.



3. **Comp** (Compression): The compression feature operates in CD mode and brings soft and loud CD passages together for a more consistent listening level. Press the COMP control until COMP ON is displayed.

4. **Mute:** Press to MUTE playing media; press again return to playing media



5. **Eject:** Press to eject a CD. Press and hold to eject all loaded discs. If disc is not removed, it will reload into the system. Works with the ignition on or off.





## Entertainment Systems

6. **Bass:** Press BASS; then press SEL ◀ / ▶ to decrease/increase the bass output.

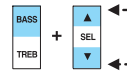

**Treble:** Press TREB; then press SEL ◀ / ▶ to decrease/increase the treble output.



7. **Select:** Use with Bass, Treble, Balance and Fade controls to adjust levels. Use with MENU to set the clock and RDS function on/off.

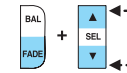

8. **Balance:** Press BAL; then press SEL ◀ / ▶ to shift sound to the left/right speakers.

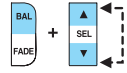

**Fade:** Press FADE; then press SEL ◀ / ▶ to shift sound to the rear/front speakers.

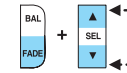

9. **Menu:** Press MENU and SEL to access clock mode, RDS on/off, Traffic announcement mode and Program type mode.

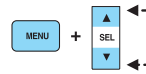

10. **Memory presets:** To set a station: Select frequency band AM/FM1/FM2; tune to a station, press and hold a preset button until sound returns.



11. **CD:** Press to select CD mode.



12. **AM/FM:** Press to select AM/FM1/FM2 frequency band. In CD mode, press to begin radio play.



## Entertainment Systems

**Autostore:** Stores the six strongest stations without erasing your current presets. To activate, press and momentarily hold AM/FM. Autostore will flash in the display. The six strongest stations will fill the memory preset buttons for AM/FM1/FM2 if enough stations are available. If not, stations will be repeated.

Press again to deactivate.

13. **Power/volume:** Press to turn ON/OFF; turn to increase or decrease volume levels.



14. **Load:** Press to load a CD. Press and hold to load up to six discs.



15. **Shuffle:** Press to play tracks and CDs in random order.



16. **Scan:** Press SCAN to move up the radio frequency band. SCAN automatically finds a station, plays it for five seconds, then moves to the next station. Press again to stop.  
**CD:** Press SCAN for a brief sampling of CD tracks. Press again to stop.



17. **Disc tune:** Radio: Press ◀ or ▶ to manually tune down or up the radio frequency band. CD: Press ◀ to select the previous track or ▶ to select the next track on the CD.



## Entertainment Systems

### REAR SEAT ENTERTAINMENT SYSTEM (IF EQUIPPED)

#### Quick Start — How to get going

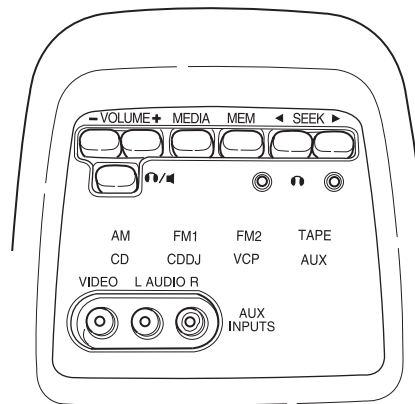



#### To operate the system:

1. Your AutoVision® system is automatically activated when the vehicle ignition and the audio system are ON.
2. If a movie is desired, insert a VHS cassette into the VCP and the video should start playing.
3. Press the MEDIA control to toggle to any other desired media source.

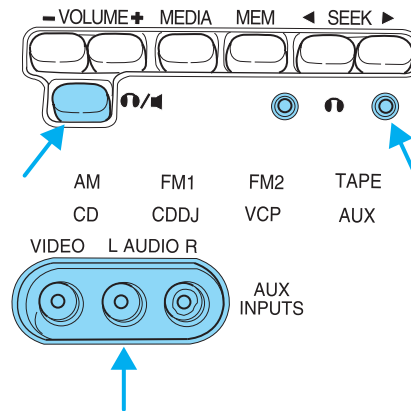
## Entertainment Systems



### To play a video game:

1. Connect the video line from your game device to the VIDEO jack.
2. Connect the left and right audio cables to the left (L) and right (R) audio jacks.
3. Ensure that the system is in AUX mode. The LCD screen will turn on and the AUX indicator will illuminate.
4. If desired, press the  /  control and plug a 3.5mm headphone into the headphone jack. With the headphones ON, the rear speakers will not operate.

Your AutoVision® System allows you to watch movie rentals and your favorite home videocassettes. It also allows you to plug in and play a variety of standard video games. Please review this user manual to become familiar with the AutoVision® features and controls as well as the very important safety information.

Should you have any questions regarding your AutoVision® System, please feel free to call the toll free assistance hotline at 1 (877) 848-6434.

### Safety information

Read all of the safety and operating instructions before operating the system and retain for future reference.

Do not attempt to service, repair or modify the AutoVision® System. See your Ford or Lincoln Mercury dealer.

## Entertainment Systems

Do not insert foreign objects into the videocassette player (VCP) tape cassette compartment.



The front glass on the liquid crystal display may break when hit with a hard surface. If the glass breaks, do not touch the liquid crystalline material. In case of contact with skin, wash immediately with soap and water.



The driver must not attempt to operate any function of the floor console mounted VCP while the vehicle is in motion. Give full attention to driving and to the road. Pull off the road and park in a safe place before inserting or extracting video tapes from the VCP. A remote control is included in the system to allow the rear seat occupants to operate the VCP functions without distracting the driver.

Be sure to review User Manuals for video games and video game equipment when used as auxiliary inputs for your AutoVision® System.

Do not operate video games or video equipment if the power cords and/or cables are broken, split or damaged. Carefully place cords and/or cables where they will not be stepped on or interfere with the operation of seats and/or compartments.

Disconnect video games and video equipment power cords and/or cables when not in use.

Avoid touching auxiliary input jacks with your fingers. Do not blow on them or allow them to get wet or dirty.

Do not clean any part of the AutoVision® system with benzene, paint thinner or any other solvent.

### ***Federal Communication Commission (FCC) Compliance***

Changes or modifications not approved by Ford Lincoln Mercury could void user's authority to operate the equipment. This equipment has been tested and found to comply with the limits for a Class B digital device, pursuant to Part 15 of the FCC Rules. These limits are designed to provide reasonable protection against harmful interference in a residential installation. This equipment generates, uses and can radiate radio frequency energy and, if not installed and used in accordance with the instructions, may cause harmful interference and radio communications.

However, there is no guarantee that interference will not occur in a particular installation. If this equipment does cause harmful interference to radio or television reception, which can be determined by turning the

## Entertainment Systems

equipment off and on, the user is encouraged to consult the dealer or an experienced radio/TV technician for help.

### **Care of the videocassette player (VCP)**

#### ***Environmental extremes***

Videocassette players subjected to harsh environmental conditions may be damaged or perform at less than maximum capability. To avoid these outcomes, avoid leaving the VCP:

- in extremely hot or cold temperatures.
- in direct sunlight.
- in high humidity.
- in a dusty environment.
- in locations where strong magnetic fields are generated.
- on a surface that is instable or subject to vibrations.

#### ***Temperature extremes***

When the vehicle is parked under direct sunlight or in an extremely cold place for a long period of time, wait until the cabin temperature of the vehicle is at normal temperature before operating the system.

#### ***High/low temperature sensor circuit***

- Excessively high or low temperatures may cause damage to the VCP.
- When the temperature of the VCP becomes too high or low, the temperature sensor circuit stops machine operation, ejects the cassette and the WAIT indicator illuminates. The lamp will remain illuminated until the system has returned to a safe operating temperature.

#### ***Humidity and moisture condensation***

Moisture in the air will condense in the VCP under extremely humid conditions or when moving from a cold place to a warm one. Moisture condensation on the tape playback head drum may damage the videocassette and/or drum. If moisture condensation occurs, do not insert a videocassette into the player. If a videocassette is already in the player, remove it. Turn the VCP power ON to dry the moisture before inserting a videocassette. This could take an hour or more.

#### ***Dew sensor circuit***

- Under high moisture (dewed) conditions, the tape heads and cassette tape may be damaged if the VCP is operated.

## Entertainment Systems

- When the vehicle's cabin temperature is very low and then is heated quickly, or the humidity is very high within the vehicle, the inside of the windows most likely will be fogged. Under these conditions, the inside of the VCP most likely is dewed.
- When a dewed condition exists, the dew sensor circuit stops machine operation, ejects the cassette and the WAIT indicator illuminates. The lamp will remain illuminated until the system is dry enough to operate safely.

### ***Cleaning video heads***

Magnetic video heads convert the videocassette into pictures on the screen during playback. Over a period of time, particles rub off the tape and are left on the heads. Using an old or poor quality tape together with dust and air particles, high temperature and humidity cause dirty heads. Dirty heads generally cause "snowy" pictures and, in some severe cases, blurred or interrupted pictures. A variety of products are available at video stores to clean tape heads. Use these products sparingly, because some are abrasive to the video heads. If normal head cleaning procedures do not resolve the problem, have the system checked by a service technician.

### ***Foreign substances***

Exercise care to prevent dirt and foreign objects from entering the VCP compartment. Be especially careful not to spill liquids of any kind onto the media controls or into the videocassette player. If liquid is accidentally spilled onto the system, immediately turn the system OFF and consult a qualified service technician.

### **AutoVision® system**

#### ***Features***

- 2-head hi-fi playback
- AutoPlay feature
- Digital auto tracking
- Dual stereo headphone with electric volume control
- Self docking connection for easy mobile installation
- Latching system for secure safety
- Carrying handle for portability
- Water resistant tape door
- On screen display
- Protection circuits

## Entertainment Systems

### **Playback and format**

- The videocassette player of your AutoVision® system can only be used in the “playback” mode. You are not able to record with your system.
- The system plays standard videocassettes marked “VHS” (or “S-VHS”).

### **VCP protection circuits**

#### **Tape protection circuit**

- When the system is in PAUSE mode, the tape mechanism will continue to create tension on the tape.
- When the VCP is in still playback, FFWD (fast forward) or REW (reverse) mode for more than five minutes, the tape protection circuit automatically returns the system to PLAY mode to avoid damage to the tape.

Your AutoVision System is also equipped with a Dew sensor circuit and a High/low temperature sensor circuit. For more information on these circuits, please refer to *Humidity and moisture condensation* and *Temperature extremes* in this chapter.

### **VCP controls**

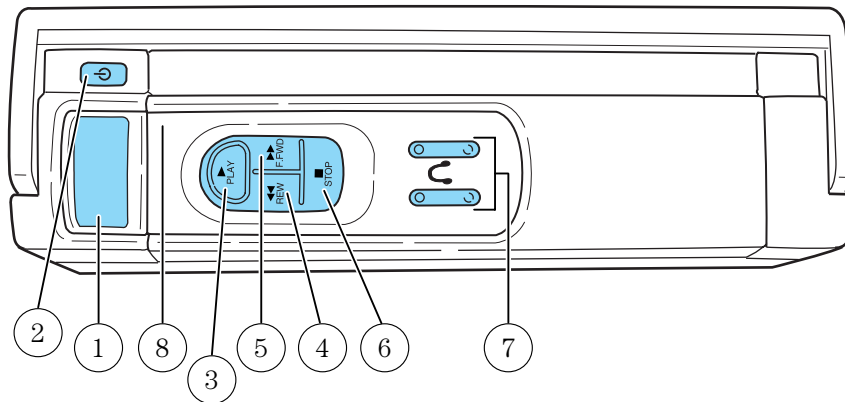

#### **1. LED display**

The display lamp will light up in green when power is supplied to the videocassette player.



## Entertainment Systems

2. **POWER** key

Press to toggle between ON/OFF. When the power is ON, other keys (PLAY, FF, REW, STOP) will illuminate.

3. **PLAY** key

Press to playback a videocassette tape.

4. **REWIND/REVIEW** button

Press to enter the reverse picture mode when in PLAYBACK mode. If in STOP mode, the tape will rewind at a high speed.

5. **FAST FORWARD/CUE** button

Press to enter forward picture search mode when in PLAYBACK mode. If in STOP mode, the tape will fast-forward at a high speed.

6. **STOP** button

Press to stop the tape.

7. **HEADPHONE VOLUME UP/DOWN KEYS** button

For home use only, please refer to the *In-Home Use* section.

8. **EJECT** button

Located inside the videocassette cover. Press to eject the tape.

## Entertainment Systems

### Remote control

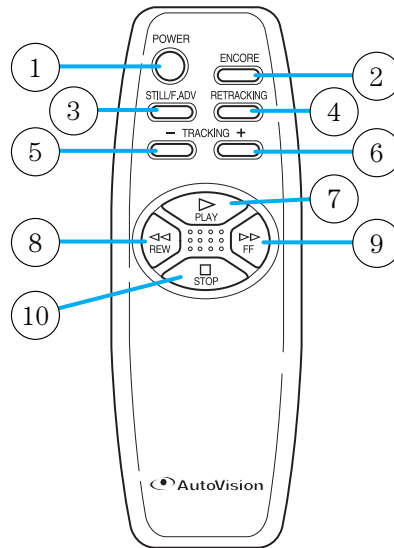

1. **POWER** button

Press to turn the videocassette player (VCP) ON or OFF.

2. **ENCORE** button

Press to reverse the cassette for 5 seconds. Normal playback will then resume when in PLAYBACK mode.

3. **STILL/ADVANCE** (frame advance button)

Press to temporarily suspend playback. Press again to make the tape advance one frame at a time.

4. **RETRACKING** button

Press to activate Auto Tracking in the playback mode.

5. **TRACKING +** button

Press for manual tape tracking.

6. **TRACKING —** button

Press for manual tape tracking.

## Entertainment Systems

7. **PLAY** button

Press to play the tape.

8. **REW** button

Press to rewind the tape.

9. **FF** button

Press to fast forward the tape.

10. **STOP** button

Press to stop the tape.

**Battery replacement**

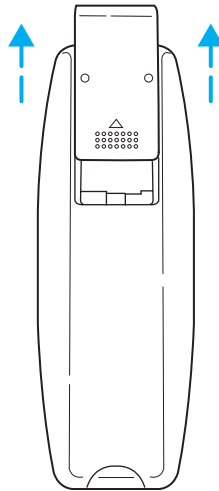

Batteries are supplied with the remote control unit. However, they are simply for operation check and will only work for a short time.

Slide battery cover off as shown on remote control to access the batteries.

The remote control unit uses two AAA batteries.

The need for battery replacement is usually indicated if the remote control only functions at extremely close distances to the entertainment center or not at all.

When replacing batteries, use two new batteries (alkaline recommended) and install with correct orientation (+ and – polarities). Ensure that you use only new batteries of the same brand.

## Entertainment Systems

If you will not be using the remote control for a considerably long time, remove the batteries.

### AutoVision® controls

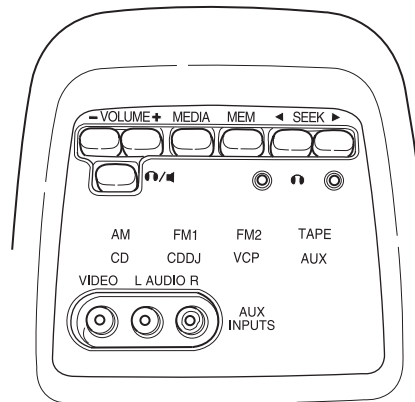

The AutoVision® controls allow the rear seat passengers to operate the radio, tape, CD or CD DJ(if equipped).

### Parental control

Your AutoVision® system allows you to have control over the rear seat controls. The system is automatically activated when the ignition is ON. This enables rear seat passengers to play a videocassette or listen to any of the available media sources. Once the headphone mode is activated, the  symbol will appear in the radio display.

Press the memory preset controls 3 and 5 simultaneously on the front audio controls to disable the AutoVision® controls. They will remain disabled until the front seat passengers “enable” them again by simultaneously pressing the 3 and 5 preset controls. The settings of the front seat controls will always override those of the rear seat controls.

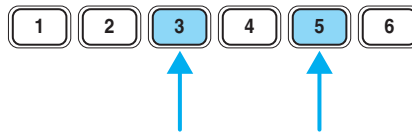

## Entertainment Systems

### **Adjusting the volume**

This control allows the rear seat passengers to adjust the volume level of the audio system.

Press the + control to increase the volume.

Press the — control to decrease the volume.

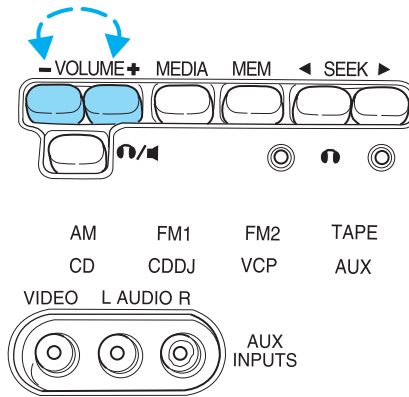

From the AutoVision® controls, the speaker volume cannot be set higher than the current volume radio setting. When in headphone mode, the AutoVision® controls can change the volume setting to any desired level.

### **Using headphones/Personal Audio Feature**

The Personal Audio Feature allows the rear seat passengers to listen to one media source (radio, TAPE, CD, CDDJ, VCP, or AUX) while the front seat passengers listen to another.

To activate, press the control and plug a 3.5mm headphone into the headphone jack. With the headphones ON, the rear speakers will not operate.

Press the MEDIA control to toggle to the desired media source.

Use the SEEK, VOLUME and MEM controls to make any desired adjustments.

Press the control again to engage the rear speakers and deactivate the Personal Audio Feature.

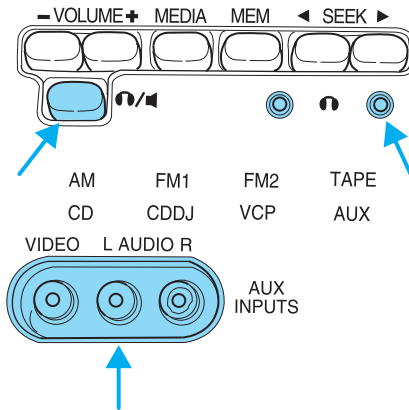

## Entertainment Systems

### **Speakers ON/OFF mode**

With the speakers ON, you can adjust the audio output to all system speakers — front and rear together (headphones are disabled in this mode). The rear seat passengers can not raise the volume of the system above the level on the front radio bezel.

With the speakers OFF, the headphones are enabled. The rear seat passengers have control over the desired volume levels.

### **Media select**

Press the MEDIA control to toggle between AM, FM1, FM2, TAPE, CD, CDDJ, VCP and AUX modes. When selected, the media source will illuminate.

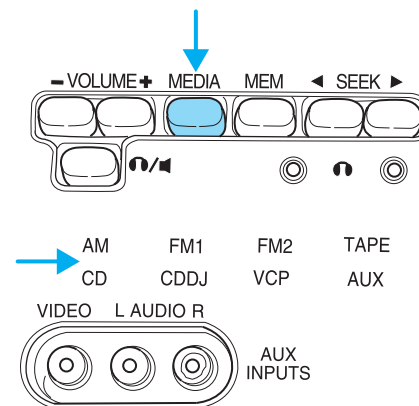

- AM — AM radio frequency band
- FM1, FM2 — FM radio frequency bands
- TAPE — cassette tape (if equipped)
- CD — single cd player (if equipped)
- CDDJ — compact disc changer (if equipped)
- VCP — video cassette player
- AUX — auxiliary jack input

## Entertainment Systems

### Memory preset control

In radio mode, press the MEM (Memory) control successively to scroll through the memory presets in AM, FM1 or FM2.

In CDDJ mode, press the MEM (Memory) control to select the next disc in the compact disc changer. Play will begin with the first track.

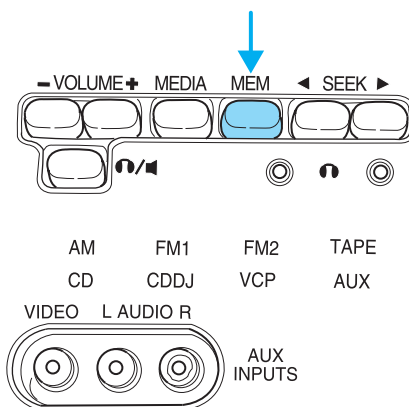

### Seek function

The SEEK control has varying functions depending on which mode is enabled.

In radio mode (AM, FM1, FM2):

Press the ◀ control to find the next listenable station down the frequency band.

Press the ▶ control to find the next listenable station up the frequency band.

In tape mode, press the SEEK control to access the previous (◀) or the next (▶) selection.

In CD mode, press the SEEK control to access the previous (◀) or the next (▶) track.

In CDDJ mode, press the SEEK control to access the previous (◀) or the next (▶) track of the currently selected disc.

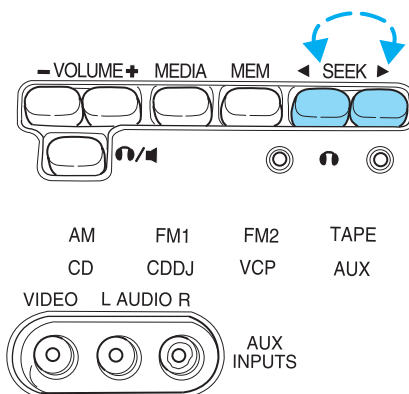

## Entertainment Systems

### Flip-down screens

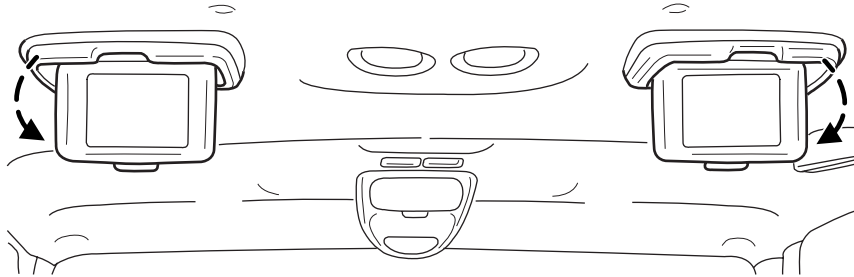

The screens rotate down to view and up into the housing to store when not in use. Ensure that the screens are latched into the housing when being stored.

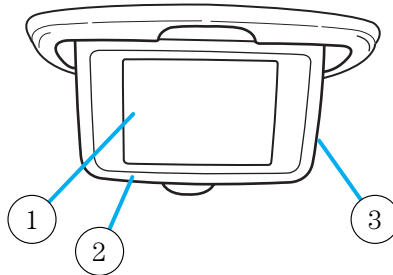

1. 6.4" (diagonal) color liquid crystal display (LCD) screen.
2. Screen housing.
3. Dimmer switch. Rotate to increase/decrease the brightness of the screen.

### General operation

- When the engine is not running, use the system sparingly otherwise it will run the battery down.
- Do not leave the videocassette in the VCP overnight or for long periods of time.
- When the ignition is turned ON, audio is through the headphones as LOW volume. Press the (+) control to increase volume. To listen through the vehicle's speaker system, press the speaker button (  ) on the media control panel.



## Entertainment Systems

### ***Inserting/removing cassette***

#### ***Inserting cassette***

- Open the AutoVision® console cover.
- Insert the videocassette into the cassette compartment.

Inserting a videocassette into the VCP automatically turns the power ON (the indicator lamp will illuminate) and the tape will begin playback.

If the vehicle is traveling over rough terrain, it may be difficult to insert the cassette because the machine attempts to hold the cassette firmly to prevent vibration. If this condition is encountered, either press firmly or remove the cassette and insert it again.

The system will not allow a cassette to be inserted in the wrong position.

- Once the cassette is completely inserted, close the VCP and console covers.

#### ***Removing cassette***

1. Open the console cover, open the VCP cover and press the STOP button.
2. Press the EJECT button.

Do not insert any foreign substances into the cassette compartment.

After removing the cassette from the VCP, close the door.

When the engine is turned OFF, the cassette is ejected from the compartment.

#### ***To play a video game***

1. Connect the video line from your video game device to the YELLOW jack.
2. Connect the left and right audio cables to the WHITE and RED jacks respectively.
3. Ensure that the system is in AUX mode. The LCD screen will turn on and the AUX indicator will illuminate.

#### ***On-screen indicators***

#### ***Playback operation***

1. Press the POWER control on the VCP.
2. Insert a videocassette into the VCP.
3. The videocassette should automatically begin playback, and the picture will appear within approximately nine seconds.

## Entertainment Systems

4. Press the STOP control to stop playback or press EJECT to remove the cassette.

### ***Fast-forward or rewind (no picture)***

1. Press the FF/REW control on the VCP.
2. Press the STOP control to stop or press EJECT to remove the cassette.

The tape will fast forward or rewind until it has reached the end or the beginning.

### ***Fast-forward or rewind (with picture)***

1. While in playback mode, momentarily press the FF/REW key. The VCP will search the playback direction five times faster than normal playback mode.
2. Press the PLAY key to resume normal playback.

### ***Special effects playback***

#### ***Still playback/Frame-to-frame playback (on remote control)***

1. Press the STILL/F.ADV key while in playback mode. The playback picture becomes still.
2. Press the STILL/F.ADV key again. Each time the control is pressed, the pictures are played back one frame at a time.

The still playback feature can also be used in REW (reverse) mode.

If still playback/or frame-to-frame playback is engaged for five minutes or longer, the VCP will automatically begin playback to protect the tape.

Automatic tracking is automatically activated the moment the VCP is turned ON or a cassette is inserted.

If a videocassette is in poor shape (i.e., badly recorded), any tracking adjustment may result in failure. The VCP will eject the videocassette.

#### ***Encore (on remote control)***

- Press the ENCORE control while in playback mode.

The VCP will reverse to the previous five seconds of the selection and then operate at normal playback mode.

## Entertainment Systems

### Auxiliary input jacks

The auxiliary input jacks on the AutoVision® control panel accept video and audio connectors for all standard video games (Nintendo®, PlayStation®, etc.) Other compatible devices such as DVD players, camcorders and portable CD players can also be connected to the auxiliary jacks.

The auxiliary jack is color-coded for identification purposes. They are as follows:

- YELLOW (1)— video input
- WHITE (2)— left channel audio input
- RED (3)— right channel audio input

Press the MEDIA control until AUX is illuminated in the control panel. This will allow you to view the video and listen to the audio from the auxiliary input.

To listen to another audio source while viewing video from the auxiliary input, press the MEDIA control until the desired media source is illuminated.

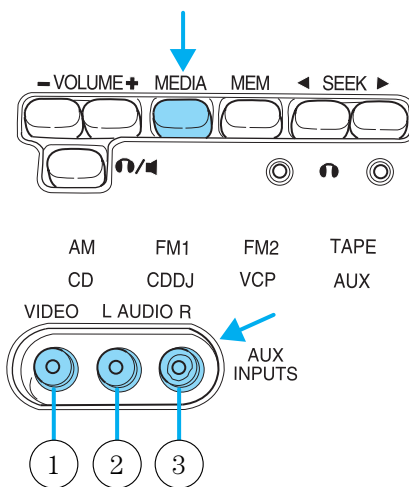

## Entertainment Systems

### Video source selection

The MEDIA control determines which video (VCP or Auxiliary input) is seen on the AutoVision® screen.

When the vehicle ignition is ON and the system is not in VCP mode, the AutoVision® selects the Auxiliary input as the video source. (If there is not a video source connected to the Auxiliary input jack, the screen will be blank.)

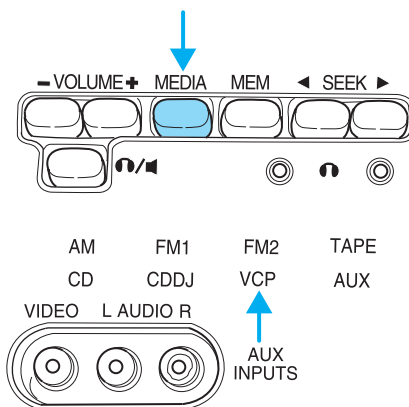

### AutoPlay feature

Your AutoVision® system is equipped with an AutoPlay Feature. When a video cassette is inserted into the player, video and audio sources are automatically switched to VCP. This will override any other selections currently made.

### Indications on the VCP

The operation and status of the VCP can be checked by the indications appearing on the LED display.

1. The **Power indicator** flashes on during POWER ON and will blink when in emergency mode.
2. The **HI-FI indicator** illuminates when a HI-FI tape is loaded.
3. The **HP1 indicator** illuminates when the headphone jack 1 is plugged in.
4. The **HP2 indicator** illuminates when the headphone jack 2 is plugged in.
5. The **Operation indicators** illuminate when the system is powered ON, a HIFI tape is being played, or headphones are being used.

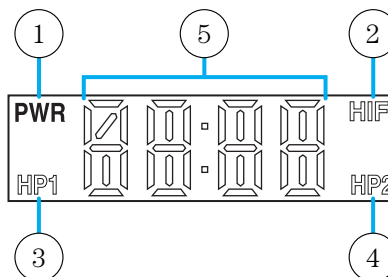

## Entertainment Systems

The following are some possible messages that may illuminate on your LED display and their meanings.

Illuminates when there is a videocassette in the system during power off.



Illuminates when there is a videocassette in the system during power on.



Illuminates when a videocassette is ejected from the system.



Flashes during emergency mode.



Illuminates during power on when there is not a videocassette present in the system.



Illuminates during power off when there is not a cassette present in the system.

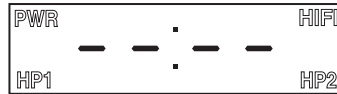

Illuminates when the videocassette is in REW (rewind) mode.



Illuminates when the videocassette is in FF (fast forward) mode.



## Entertainment Systems

Illuminates when the videocassette is in STIL (pause) mode.



Illuminates when the videocassette is in PLAY mode.



Illuminates when the videocassette is in REV (review) mode.



Illuminates when the videocassette is in CUE mode.



Flashes separately when the videocassette is in ENCORE mode.



Displays when:

- the thermostat detects an extremely high or low temperature, or
- the dew sensor is activated for high humidity



## Entertainment Systems

### In-home use

Your AutoVision® system is UL registered for in-home use. This system has the unique feature of also being completely portable and able to be used in your home.

To remove your AutoVision® system from your vehicle, depress the lever on the center console labeled VCP RELEASE. This will release the VCP and enable you to remove the system from the vehicle. If pressing the lever does not release your system, please contact your dealer.

To re-install the VCP in your vehicle, insert the VCP into the console and push lightly until the VCP clicks into place.

To use the AutoVision® system in your home, you will need:

- a DC 12V power converter rated for 1.5 amps/min and
- Patch cords with RCA style connectors

These parts are available in your local electronics store or call toll free 1 (877) 848-6434 for assistance.

### Auxiliary jacks for home use

#### 1. VIDEO OUT

Connect this terminal to the VIDEO IN terminal of your display (LCD, TV).

#### 2. DC jack in

Connect this jack to the DC source (DC 12V).

#### 3. AUDIO OUT LR

Connect these terminal(s) to the AUDIO IN terminals of your display (LCD, TV).

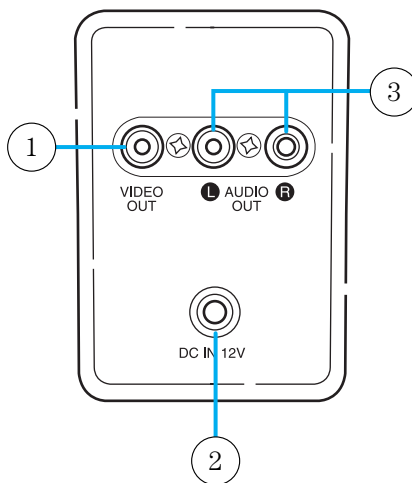

## Entertainment Systems

### 1. VIDEO IN

Connect this terminal to the AUDIO OUT terminal of your other apparatus (DVD, game machine, etc.).

### 2. AUDIO IN LR

Connect these terminal(s) to the AUDIO OUT terminals of your other apparatus (DVD, game machine, etc.).

### 3.

Plug headphones into these jacks.

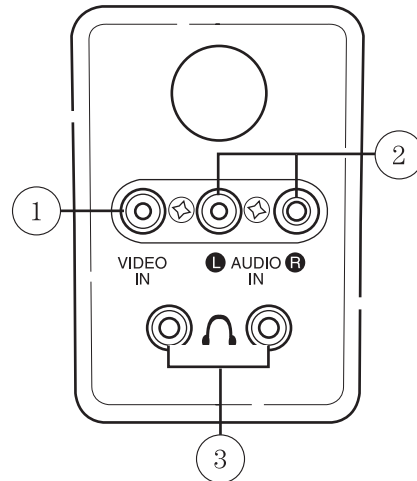

## RADIO FREQUENCIES

AM and FM frequencies are established by the Federal Communications Commission (FCC) and the Canadian Radio and Telecommunications Commission (CRTC). Those frequencies are:

AM - 530, 540–1700, 1710 kHz

FM- 87.7, 87.9–107.7, 107.9 MHz

## RADIO RECEPTION FACTORS

There are three factors that can effect radio reception:

- Distance/strength: The further you travel from an FM station, the weaker the signal and the weaker the reception.
- Terrain: Hills, mountains, tall buildings, power lines, electric fences, traffic lights and thunderstorms can interfere with your reception.
- Station overload: When you pass a broadcast tower, a stronger signal may overtake a weaker one and play while the weak station frequency is displayed.

## CASSETTE/PLAYER CARE

Do:

- Use only cassettes that are 90 minutes long or less.



## Entertainment Systems

- Tighten very loose tapes by inserting a finger or pencil into the hole and turning the hub.
- Remove loose labels before inserting tapes.
- Allow tapes which have been subjected to extreme heat, humidity or cold to reach a moderate temperature before playing.
- Clean the cassette player head with a cassette cleaning cartridge after 10–12 hours of play to maintain good sound/operation.

Don't:

- Expose tapes to direct sunlight, extreme humidity, heat or cold.
- Leave tapes in the cassette player for a long time when not being played.

### CD/CD PLAYER CARE

Do:

- Handle discs by their edges only. Never touch the playing surface.
- Inspect discs before playing. Clean only with an approved CD cleaner and wipe from the center out.

Don't:

- Expose discs to direct sunlight or heat sources for extended periods of time.
- Insert more than one disc into each slot of the CD changer magazine.
- Clean using a circular motion.

**CD units are designed to play commercially pressed 12 cm (4.75 in) audio compact discs only. Due to technical incompatibility, certain recordable and re-recordable compact discs may not function correctly when used in Ford CD players. Irregular shaped CDs, CDs with a scratch protection film attached, and CDs with homemade paper (adhesive) labels should not be inserted into the CD player. The label may peel and cause the CD to become jammed. It is recommended that homemade CDs be identified with permanent felt tip marker rather than adhesive labels. Ball point pens may damage CDs. Please contact your dealer for further information.**

### AUDIO SYSTEM WARRANTY AND SERVICE

Refer to the *Warranty Guide* for audio system warranty information. If service is necessary, see your dealer or qualified technician.

## Climate Controls

### HEATER ONLY SYSTEM (IF EQUIPPED)

1. **Fan speed adjustment:** Controls the volume of air circulated in the vehicle.

2. **Air flow selections:** Controls the direction of the airflow in the vehicle. See the following for a brief description on each control.

3. **Temperature selection:** Controls the temperature of the airflow in the vehicle.

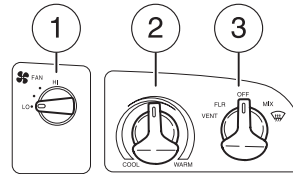



 : Distributes outside air through the instrument panel vents.

**O (OFF):** Outside air is shut out and the fan will not operate.

 : Distributes outside air through the instrument panel vents and the floor vents.

 : Distributes outside air through the floor vents.

 : Distributes outside air through the windshield defroster vents and floor vents.

 : Distributes outside air through the windshield defroster vents.

### Operating tips

- To reduce fog build up on the windshield during humid weather, place the air flow selector in the  position.
- To reduce humidity build up inside the vehicle during cold or warm weather, do not drive with the air flow selector in the OFF position.
- Under normal weather conditions, do not leave the air flow selector in OFF when the vehicle is parked. This allows the vehicle to “breathe” using the outside air inlet vents.
- Do not put objects under the front seats that will interfere with the air flow to the back seats.
- Remove any snow, ice or leaves from the air intake area at the base of the windshield.

To aid in side window defogging/demisting in cold weather:

1. Select 
2. Set the temperature control to full heat

## Climate Controls

3. Set the fan speed to HI

4. Direct the outer instrument panel vents towards the side windows

To increase airflow to the outer instrument panel vents, close the vents located in the middle of the instrument panel.



Do not place objects on top of the instrument panel as these objects may become projectiles in a collision or sudden stop.

### MANUAL HEATING AND AIR CONDITIONING SYSTEM

**1. Fan speed adjustment:** Controls the volume of air circulated in the vehicle.

**2. Temperature selection:**

Controls the temperature of the airflow in the vehicle.

**3. Air flow selections:** Controls the direction of the airflow in the vehicle. See the following for a brief description on each control.

**MAX A/C:** Uses recirculated air to cool the vehicle. Air flows from the instrument panel vents only.

**A/C:** Uses outside air to cool the vehicle. Air flows from the instrument panel vents only.

: Distributes outside air through the instrument panel vents.

**O (OFF):** Outside air is shut out and the fan will not operate.

: Distributes outside air through the instrument panel vents and the floor vents.

: Distributes outside air through the floor vents.

: Distributes outside air through the windshield defroster vents and floor vents.

: Distributes outside air through the windshield defroster vents.

### Operating tips

- To reduce fog build up on the windshield during humid weather, place the air flow selector in the position.
- To reduce humidity build up inside the vehicle: do not drive with the air flow selector in the OFF or MAX A/C position.

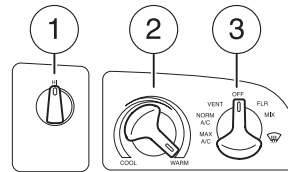

## Climate Controls

- Under normal weather conditions, do not leave the air flow selector in MAX A/C or OFF when the vehicle is parked. This allows the vehicle to “breathe” using the outside air inlet vents.
- Do not put objects under the front seats that will interfere with the airflow to the back seats.
- Remove any snow, ice or leaves from the air intake area at the base of the windshield.

To aid in side window defogging/demisting in cold weather:

1. Select 
2. Select A/C
3. Modulate the temperature control to maintain comfort.
4. Set the fan speed to HI
5. Direct the outer instrument panel vents towards the side windows

To increase airflow to the outer instrument panel vents, close the vents located in the middle of the instrument panel.



Do not place objects on top of the instrument panel as these objects may become projectiles in a collision or sudden stop.

### AUXILIARY SYSTEM (IF EQUIPPED)

Your vehicle may be equipped with auxiliary climate controls which allow you to control the airflow level in the rear of the vehicle. The front controls will still control the temperature setting.

To allow the rear passengers to control the fan speed, the front auxiliary unit must be turned to the REAR CTRL position.

Once the front auxiliary control is set to REAR CTRL, the rear passengers may select the fan speed from the rear auxiliary unit located in the overhead between the second and third row seating.

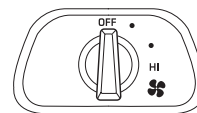
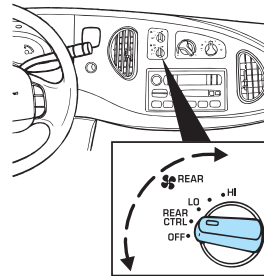

## Lights

### HEADLAMP CONTROL ☼

- The first position turns on the parking, tail, license plate and side marker lamps.
- The outer position turns on the headlamps.

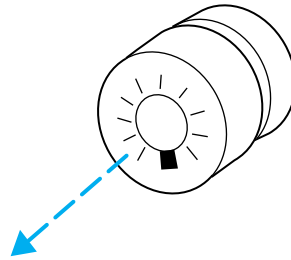

### Daytime running lamps (DRL) (if equipped)

Turns the headlamps on with a reduced output.

To activate:

- the ignition must be in the ON position and
- the headlamp control is in the OFF, parking lamp or autolamp position.

 Always remember to turn on your headlamps at dusk or during inclement weather. The Daytime Running Lamp (DRL) system does not activate with your tail lamps and generally may not provide adequate lighting during these conditions. Failure to activate your headlamps under these conditions may result in a collision.

### High beams ≡D

Push the lever toward the instrument panel to activate. Pull the lever towards you to deactivate.

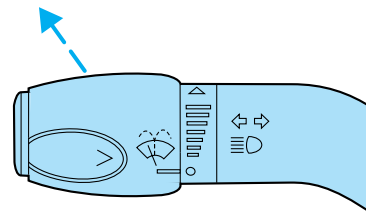

## Lights

### Flash to pass

Pull toward you slightly to activate and release to deactivate.

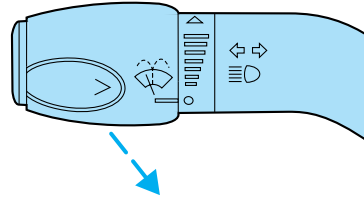

### PANEL DIMMER CONTROL

To adjust the brightness of the instrument panel, rotate the dimmer control clockwise/counterclockwise when the headlamp control is in the parking lamp or low-beam position.

To turn on the interior lamps, rotate the dimmer control fully counterclockwise

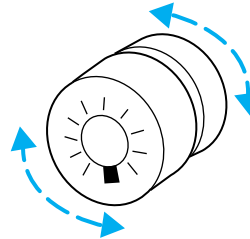

The dome lamp will not illuminate if the control switch is in the OFF position.

### AIMING THE HEADLAMPS

The headlamps on your vehicle are properly aimed at the assembly plant. If your vehicle has been in an accident the alignment of your headlamps should be checked by a qualified service technician.

### TURN SIGNAL CONTROL

- Push down to activate the left turn signal.
- Push up to activate the right turn signal.

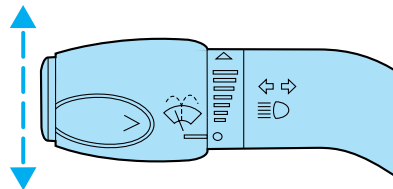

### INTERIOR LAMPS

#### Cargo and dome lamps with rear headliner

Rear cargo lamps equipped with an ON/OFF/DOOR control will light when:

- doors are closed and the control is in the ON position
- control is in the DOOR position and any door is open
- headlamp control is rotated fully counterclockwise

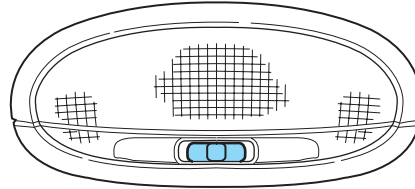

When the control is in the OFF position, it will not illuminate when you open the doors or fully rotate the headlamp control.

#### Cargo and dome lamps without rear headliner

If your vehicle is equipped with a bypass switch on the rear dome lamp, all of the dome lamps may be turned off only with the rear doors open. While the switch is in rear door bypass mode, the dome lamps will light as normal when any other door is open or the headlamp control is rotated fully counterclockwise. If the switch is not in the bypass position, opening the rear doors will light the dome lamp as normal.

#### Front and rear courtesy/reading lamps

The dome portion of the lamp, the center light, can be turned on when the headlamp control is rotated fully counter clockwise or when any door is opened.

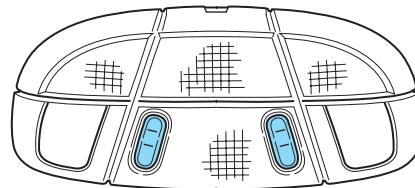

The reading lamp portion, the two outer lights, can only be toggled on and off at the lamp.

### BULBS

#### Replacing exterior bulbs

Check the operation of all the bulbs frequently.

#### Using the right bulbs

Replacement bulbs are specified in the chart below. Headlamp bulbs must be marked with an authorized "D.O.T." for North America and an

## Lights

“E” for Europe to assure lamp performance, light brightness and pattern and safe visibility. The correct bulbs will not damage the lamp assembly or void the lamp assembly warranty and will provide quality bulb burn time.

Function	Number of bulbs	Trade number
Headlamps (low series)	2	H5054
Headlamps (high series)	2	9007
Park lamp and turn signal (front)	2	3157 AK (amber)
Back-up lamps	2	3156K
License plate lamp	1	168
Stop/tail/turn/side marker lamp	2	3357 K
High-mount brakelamp	2	912
Cargo lamp	1	211-2
Dome lamp (standard)	1	912
Map/reading lamp	2	211-2
Roofmarker	5	194
All replacement bulbs are clear in color except where noted.		
To replace all instrument panel lights - see your dealer		

### Replacing headlamp bulbs (aerodynamic)

1. Make sure headlamp switch is in the OFF position and open the hood.
2. Push each clip tab toward the engine compartment and lift upward to the stop position, then remove the headlamp assembly.

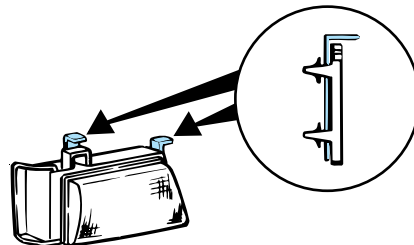



## Lights

3. Disconnect the electrical connector from the bulb by pulling rearward.

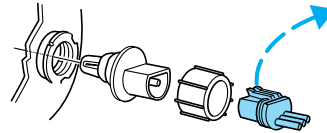

4. Remove the bulb retaining ring by rotating it counterclockwise, and slide the ring off the plastic base.

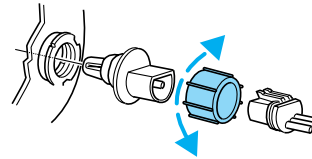

5. Pull the bulb straight out.

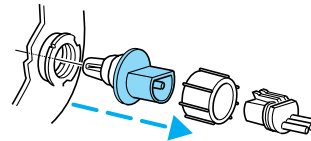

Handle a halogen headlamp bulb carefully and keep out of children's reach. Grasp the bulb only by its plastic base and do not touch the glass. The oil from your hand could cause the bulb to break the next time the headlamps are operated.

**NOTE:** If the bulb is accidentally touched, it should be cleaned with alcohol before being used.

To install the new bulb, follow the removal procedures in reverse order.

### **Replacing headlamp bulbs (low series)**

1. Make sure headlamp switch is in the OFF position and open the hood.
2. Remove the two headlamp screws and bezel from the headlamp housing.

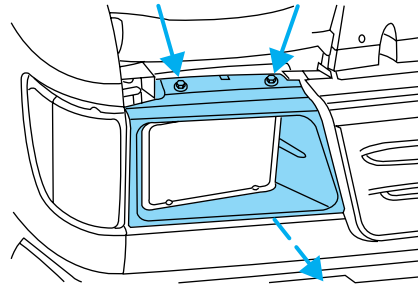

## Lights

3. Remove the four headlamp bulb retaining screws and the retaining ring.
4. Remove the headlamp.
5. Disconnect the electrical connector from the bulb and remove the bulb.

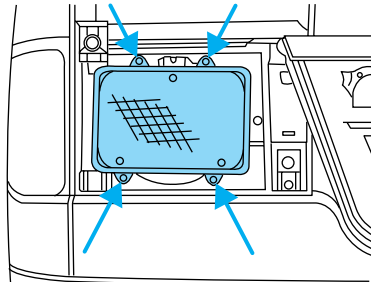

To install the new bulb, follow the removal procedures in reverse order.

### **Replacing front parking lamp/turn signal bulbs**

1. Make sure the headlamp control is in the OFF position and then open the hood.
2. Remove two screws and pull lamp assembly away from the vehicle.
3. Rotate the bulb socket counterclockwise and remove.
4. Carefully pull the bulb straight out of the socket.

To complete installation, follow the removal procedures in reverse order.

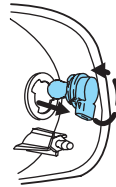

### **Replacing roof marker bulbs**

1. Remove the screw and lens from the lamp assembly.
2. Carefully pull the bulb straight out of the socket and push in the new bulb.
3. Install lens on lamp assembly with screw.

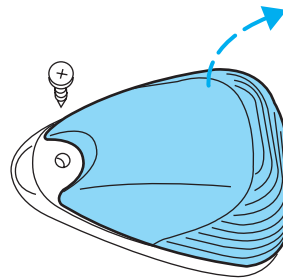

### **Replacing high-mount brakelamp bulbs**

The interior cargo lamp (if equipped), on vehicles without a rear headliner, will have to be removed from under the high-mount brakelamp assembly located inside the vehicle. Then:

1. Remove the two screws from the high-mount brakelamp assembly and lift the lamp from the vehicle.
2. Remove the bulb socket from the lamp assembly by turning counterclockwise.
3. Carefully pull the bulb straight out of the socket.

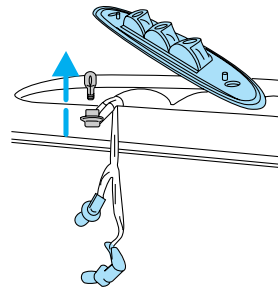

To install the new bulb, follow the removal procedure in reverse order.

### **Replacing license plate lamp bulbs**

1. Turn the headlamp switch to OFF and then remove the two screws and the license plate lamp assembly from the rear door.
2. Remove bulb socket from lamp assembly by turning counterclockwise.
3. Pull the bulb out from socket and push in the new bulb.

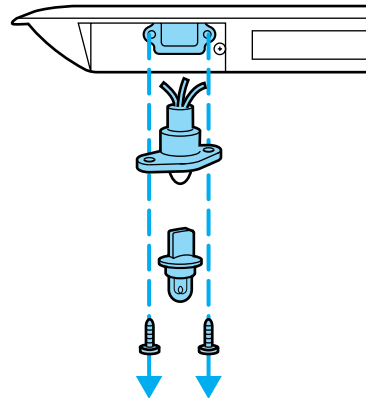

To install the new bulb, follow the removal procedures in reverse order.

## Lights

### **Replacing tail lamp/turn/backup lamp bulbs**

1. Turn the headlamp switch to the OFF position and then remove the four screws and the lamp assembly from vehicle.

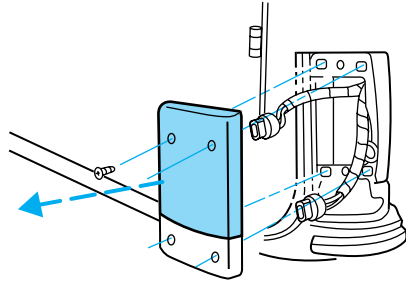

2. Rotate bulb socket counterclockwise and remove from lamp assembly.

3. Carefully pull the bulb straight out of the socket and push in the new bulb.

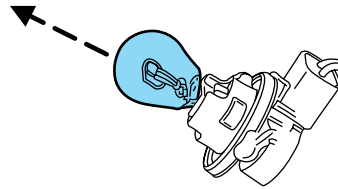

To install the lamp, follow the removal procedures in reverse order.

### **Replacing brake/tail/backup lamp bulbs — Chassis or cutaway cab**

1. Make sure the headlamp switch is in the OFF position.

2. Remove the four screws and the lamp from the lamp assembly.

3. Carefully pull the bulb straight out of the socket and push in the new bulb.

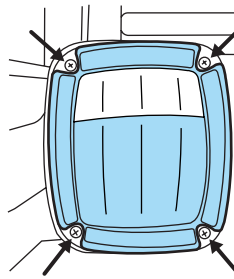

## Driver Controls

### MULTI-FUNCTION LEVER

**Windshield wiper:** Rotate the end of the control away from you to increase the speed of the wipers; rotate towards you to decrease the speed of the wipers.

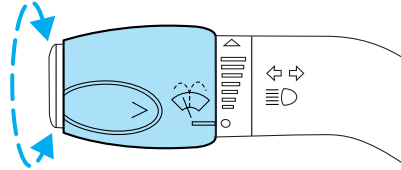

**Windshield washer:** Push the end of the stalk:

- briefly: causes a single swipe of the wipers without washer fluid.
- a quick push and hold: the wipers will swipe three times with washer fluid.
- a long push and hold: the wipers and washer fluid will be activated for up to ten seconds.

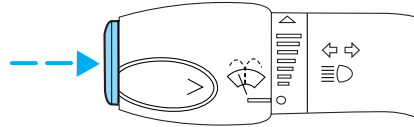

### Changing the wiper blades

1. Pull the wiper arm away from the vehicle. Turn the blade at an angle from the wiper arm. Push the lock pin manually to release the blade and pull the wiper blade down toward the windshield to remove it from the arm.

2. Attach the new wiper to the wiper arm and press it into place until a click is heard.

3. Replace wiper blades every 6 months for optimum performance.

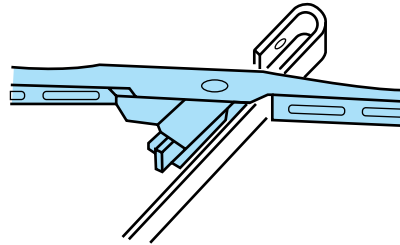

## Driver Controls

### TILT STEERING WHEEL

To adjust the steering wheel:

1. Pull and hold the steering wheel release control toward you.
2. Move the steering wheel up or down until you find the desired location.
3. Release the steering wheel release control. This will lock the steering wheel in position.

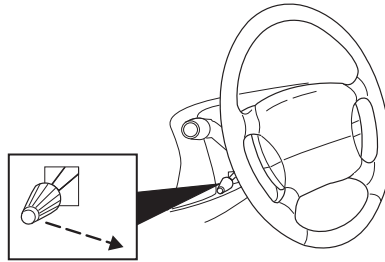

Never adjust the steering wheel when the vehicle is moving.

### OVERHEAD CONSOLE (IF EQUIPPED)

The appearance of your vehicle's overhead console will vary according to your option package.

#### Storage compartment (if equipped)

Press the OPEN control to open the storage compartment. The door will open slightly and can be moved to full open.

The storage compartment may be used to secure sunglasses or a similar object.

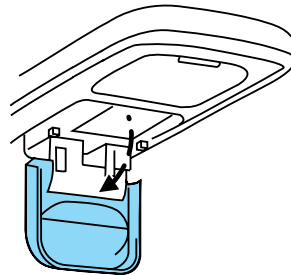

## Driver Controls

### Installing a garage door opener (if equipped)

The storage compartment can be converted to accommodate a variety of aftermarket garage door openers:

1. Remove the storage clip from the door.
2. Place Velcro hook onto side of aftermarket transmitter opposite of actuator control.
3. Place the transmitter into storage compartment, control down.

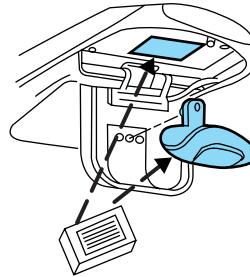

4. Place the provided height adaptors onto the back of the GARAGE control as needed.
5. Press the GARAGE control to activate the transmitter.

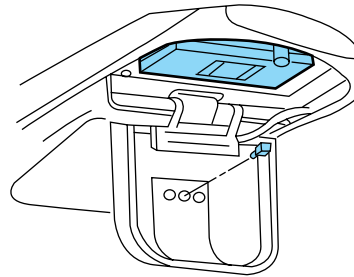

### Electronic compass/temperature display (if equipped)

#### Outside air temperature

The outside temperature display is contained in the overhead console.

The temperature display can be turned off and on by pressing the SELECT control on the overhead console. The temperature can be displayed in Centigrade or Fahrenheit by pressing the SELECT control.

If the outside temperature falls below 3°C (38°F), the display will alternate from “ICE” to the outside temperature at a two second rate for one minute.

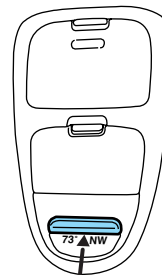

## Driver Controls

### Compass

The compass display is contained in the overhead console. The vehicle heading is displayed as one of N, NE, E, SE, S, SW, W and NW.

The compass reading may be affected when you drive near large buildings, bridges, power lines and powerful broadcast antenna. Magnetic or metallic objects placed in or on the vehicle may also affect compass accuracy. Adjustments may need to be made to the zone and calibration of the compass.

#### Compass zone adjustment

1. Determine which magnetic zone you are in by referring to the zone map.
2. Turn the ignition to the ON position.

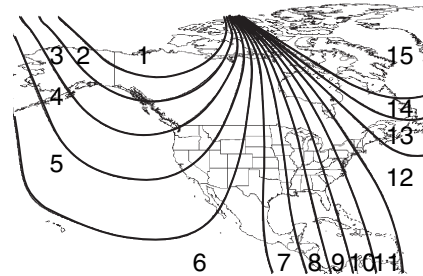

3. Press and hold the SELECT control until VAR appears in the display, then release. The display should show the current zone number.

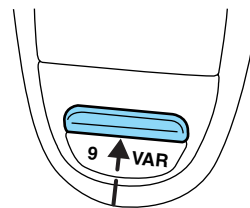

4. Press the SELECT control until the desired zone number appears. The display will flash and then return to normal operation. The zone is now updated.

#### Compass calibration adjustment

Perform this adjustment in an open area free from steel structures and high voltage lines:

- Press and hold the SELECT control until CAL appears in the display (approximately eight seconds) and release.

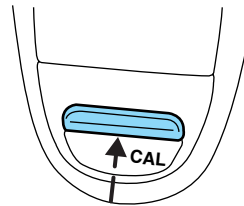



## Driver Controls

- Drive the vehicle slowly (less than 5 km/h [3 mph]) in circles until CAL indicator turns off in about 2–3 complete circles.
- The compass is now calibrated.

### CELL PHONE USE

The use of Mobile Communications Equipment has become increasingly important in the conduct of business and personal affairs. However, driver's must not compromise their own or other's safety when using such equipment. Mobile Communications can enhance personal safety and security when appropriately used, particularly in emergency situations. Safety must be paramount when using mobile communications equipment to avoid negating these benefits.

Mobile Communication Equipment includes, but is not limited to cellular phones, pagers, portable email devices, in vehicle communications systems, telematics devices and portable two-way radios.



A driver's first responsibility is the safe operation of the vehicle. The most important thing you can do to prevent a crash is to avoid distractions and pay attention to the road. Wait until it is safe to operate Mobile Communications Equipment.

### AUXILIARY POWER POINT 12V

**Power outlets are designed for accessory plugs only. Do not hang any type of accessory or accessory bracket from the plug. Improper use of the power outlet can cause damage not covered by your warranty.**

The auxiliary power point is located on the instrument panel.

A second power point (if equipped) is located behind the driver's seat on the upper trim panel.

**Do not plug optional electrical accessories into the cigarette lighter. Use the power point.**

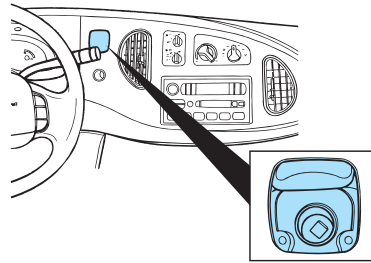

## Driver Controls

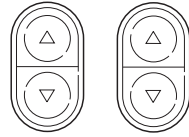

### POWER WINDOWS (IF EQUIPPED)

Press and hold the bottom part of the rocker switch to open the window. Press and hold the top part of the rocker switch to close the window.



### POWER SIDE VIEW MIRRORS (IF EQUIPPED)

To adjust your mirrors

1. Select  to adjust the left mirror or  to adjust the right mirror.
2. Move the control in the direction you wish to tilt the mirror.
3. Return to the center position to disable the adjust function.

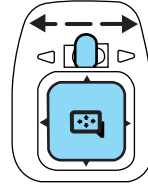

### Spotter mirror (if equipped)

Move the mirror manually to increase side and rear visibility.

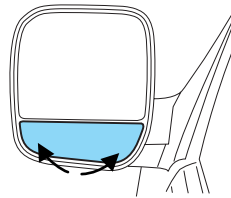

## Driver Controls

### Fold-away mirrors

Fold the side mirrors in carefully when driving through a narrow space, like an automatic car wash.

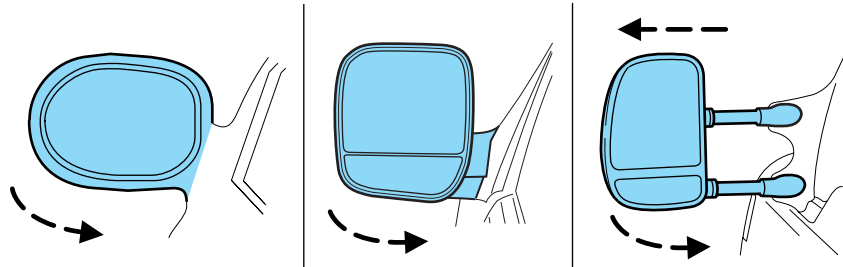

The telescoping feature (if equipped) allows the mirror to extend approximately 76 mm (3 inches).

### SPEED CONTROL (IF EQUIPPED)

With speed control set, you can maintain a speed of 48 km/h (30 mph) or more without keeping your foot on the pedal. Speed control does not work at speeds below 48 km/h (30 mph).



Do not use the speed control in heavy traffic or on roads that are winding, slippery or unpaved.

### Setting speed control

The controls for using your speed control are located on the steering wheel for your convenience.

1. Press the ON control and release it.
2. Accelerate to the desired speed.

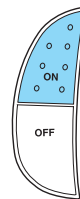

## Driver Controls

3. Press the SET ACCEL control and release it.
4. Take your foot off the accelerator pedal.
5. The indicator light on the instrument cluster will turn on.



### Note:

- Vehicle speed may vary momentarily when driving up and down a steep hill.
- If the vehicle speed increases above the set speed on a downhill, you may want to apply the brakes to reduce the speed.
- If the vehicle speed decreases more than 16 km/h (10 mph) below your set speed on an uphill, your speed control will disengage.

### Resuming a set speed

Press the RES (resume) control and release it. This will automatically return the vehicle to the previously set speed. The RES control will not work if the vehicle speed is not faster than 48 km/h (30 mph).



### Increasing speed while using speed control

There are two ways to set a higher speed:

- Press and hold the SET ACCEL control until you get to the desired speed, then release the control. You can also use the SET ACCEL control to operate the Tap-Up function. Press and release this control to increase the vehicle set speed in small amounts by 1.6 km/h (1 mph).
- Use the accelerator pedal to get to the desired speed. When the vehicle reaches that speed press and release the SET ACCEL control.



## Driver Controls

### **Reducing speed while using speed control**

There are two ways to reduce a set speed:

- Press and hold the COAST control until you get to the desired speed, then release the control. You can also use the COAST control to operate the Tap-Down function. Press and release this control to decrease the vehicle set speed in small amounts by 1.6 km/h (1 mph).
- Depress the brake pedal until the desired vehicle speed is reached, press the SET ACCEL control.

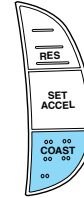

### **Turning off speed control**

There are two ways to turn off the speed control:

- Depress the brake pedal or the clutch pedal (if equipped). This will not erase your vehicles previously set speed.
- Press the speed control OFF control.

**Note:** When you turn off the speed control or the ignition, your speed control set speed memory is erased.

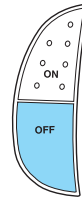

### **Indicator light (if equipped)**

This light comes on when either the SET ACCEL or RES controls are pressed. It turns off when the speed control OFF control is pressed, the brake is applied or the ignition is turned to the OFF position.

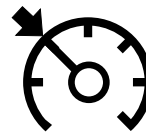

## Driver Controls

### LUGGAGE RACK (IF EQUIPPED)

Load the luggage as far back as safely possible on the rack without exceeding the gross vehicle weight rating (GVWR) or the gross axle weight rating (GAWR). Use tie down loops to secure the load.

 Vehicles with a higher center of gravity such as utility and four-wheel drive vehicles handle differently than vehicles with a lower center of gravity. Utility and four-wheel drive vehicles are not designed for cornering at speeds as high as passenger cars any more than low-slung sport cars are designed to perform satisfactorily under off-road conditions. Avoid sharp turns, excessive speed and abrupt maneuvers in these vehicles. Failure to drive cautiously could result in an increase risk of loss of vehicle control, vehicle rollover, personal injury and death.

### CARGO ORGANIZER (IF EQUIPPED)

Your vehicle comes equipped with a cargo organizer located on the floor of the cargo area.

- To open, lift the cargo organizer up to the upright position, pull the front panel away from the rear panel sliding it to the right until it locks.
- To close, press the release button, slide the front panel towards the rear panel and fold down to the stowed position.
- To remove, lift the cargo organizer up to the upright position, unscrew the screw caps on each side of the organizer and remove.

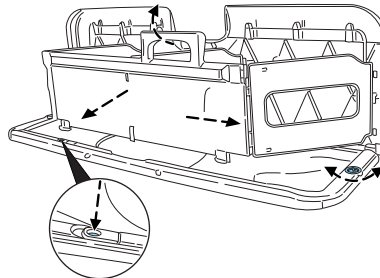

 This cargo organizer is not designed to restrain objects during a collision.

## Locks and Security

### KEYS

The key operates all locks on your vehicle. In case of loss, replacement keys are available from your dealer.

You should always carry a second key with you in a safe place in case you require it in an emergency.

### POWER DOOR LOCKS (IF EQUIPPED)

Press U to unlock all doors and L to lock all doors.

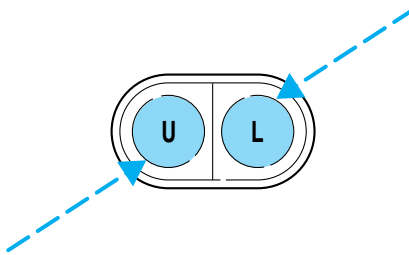

### Memory lock

If you lock your doors with the power lock switch or the remote transmitter while the sliding door is open, the door will automatically lock after it is closed.

### Back cargo door lock (if equipped)

The passenger side rear cargo door has a power door lock control mounted on the inside of the door. When this lock is pressed, all doors will lock/unlock.

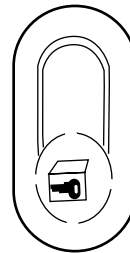

## Locks and Security

### REMOTE ENTRY SYSTEM (IF EQUIPPED)

This device complies with part 15 of the FCC rules and with RS-210 of Industry Canada. Operation is subject to the following two conditions: (1) This device may not cause harmful interference, and (2) This device must accept any interference received, including interference that may cause undesired operation.



**Changes or modifications not expressly approved by the party responsible for compliance could void the user's authority to operate the equipment.**

The remote entry system allows you to lock or unlock all vehicle doors without a key. **Note:** lock and unlock will work in any ignition position.

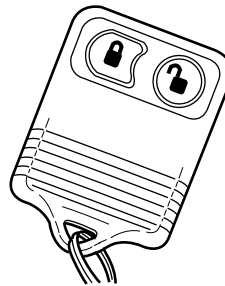

If there is a problem with the remote entry system make sure to take **ALL remote entry transmitters** with you to the dealership, this will aid in troubleshooting the problem.



#### Unlocking the doors

1. Press  and release to unlock the driver's door. **Note:** The interior lamps and puddle lamps (if equipped) will illuminate.
2. Press  and release again within three seconds to unlock all the doors.

#### Locking the doors

1. Press  and release to lock all the doors.
2. Press  and release again within three seconds to confirm that all the doors are closed and locked. **Note:** the doors will lock again, and the horn will chirp once.

#### Sounding a panic alarm

Press  to activate the alarm. Press again or turn the ignition to ACC or ON to deactivate.

**Note:** The panic alarm will only operate when the ignition is in the OFF position.



## Locks and Security

### Replacing the battery

The remote entry transmitter uses one coin type three-volt lithium battery CR2032 or equivalent. The typical operating range for your remote entry transmitter is approximately 10 meters (33 feet). A decrease in the operating range could be caused by:

- weather conditions,
- nearby radio towers,
- structures around the vehicle and
- other vehicles parked next to the vehicle.

To replace the battery:

1. Twist a thin coin between the two halves of the remote entry transmitter near the key ring. **DO NOT TAKE THE FRONT PART OF THE REMOTE ENTRY TRANSMITTER APART.**
2. Remove the old battery.
3. Insert the new battery. Refer to the diagram inside the remote entry transmitter for the correct orientation of the battery.
4. Snap the two halves back together.

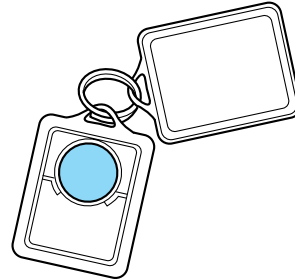

**Note:** Replacement of the battery will **not** cause the remote transmitter to become deprogrammed from your vehicle. The remote transmitter should operate normally after battery replacement.

### Replacing lost remote entry transmitters

If you would like to have your remote entry transmitter reprogrammed because you lost one, or would like to buy additional remote entry transmitters, you can either reprogram them yourself, or take **all remote entry transmitters** to your authorized dealer for reprogramming.

### *How to reprogram your remote entry transmitters*

You must have **all remote entry transmitters** (maximum of four) available before beginning this procedure.

## Locks and Security

To reprogram the remote entry transmitters:

1. Ensure the vehicle is electronically unlocked.
2. Put the key in the ignition.
3. Turn the key from the LOCK position to OFF.
4. Cycle, eight times, rapidly (within 10 seconds) between the OFF position and ON. **Note:** The eighth turn must end in the ON position.
5. The doors will lock, then unlock, to confirm that the programming mode has been activated.
6. Within 20 seconds press any button on the remote entry transmitter. **Note:** If more than 20 seconds have passed you will need to start the procedure over again.
7. The doors will lock, then unlock, to confirm that this remote entry transmitter has been programmed.
8. Repeat Step 6 to program each additional remote entry transmitter.
9. Turn the ignition to the OFF position after you have finished programming all of the remote entry transmitters.
10. The doors will lock, then unlock, to confirm that the programming mode has been exited.

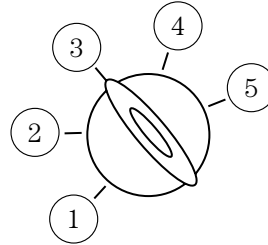

### Illuminated entry

The interior lamps illuminate when the remote entry system is used to unlock the door(s) or sound the personal alarm.

The illuminated entry system will turn off the interior lights if:

- the ignition switch is turned to the RUN or ACC position, or
- the remote transmitter lock control is pressed, or
- after 25 seconds of illumination.

The dome lamp control (if equipped) must **not** be set to the OFF position for the illuminated entry system to operate.

The inside lights will not turn off if:

- they have been turned on with the dimmer control, or
- any door is open.

## Seating and Safety Restraints

### SEATING

#### Notes:

 Reclining the seatback can cause an occupant to slide under the seat's safety belt, resulting in severe personal injuries in the event of a collision.

 Do not pile cargo higher than the seatbacks to reduce the risk of injury in a collision or sudden stop.

#### Adjusting the front manual seat

 Never adjust the driver's seat or seatback when the vehicle is moving.

 Always drive and ride with your seatback upright and the lap belt snug and low across the hips.

Lift handle to move seat forward or backward.

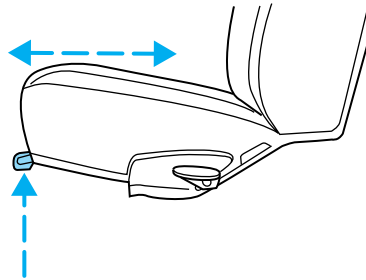

## Seating and Safety Restraints

Pull lever up to adjust seatback.

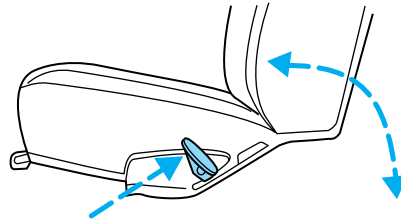

### Using the manual lumbar support

The lumbar support control is located on the inboard side of the driver's seat.

Turn the lumbar support control clockwise to increase firmness.

Turn the lumbar support control counterclockwise to increase softness.

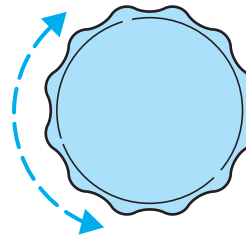

### Adjusting the front power seat (if equipped)

The control is located on the outboard side of the seat cushion.

Press to raise or lower the front portion of the seat cushion.

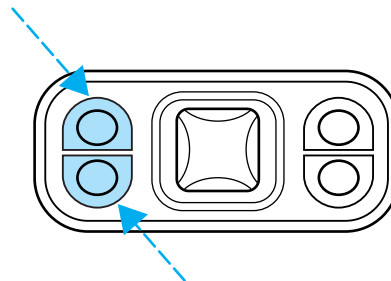

## Seating and Safety Restraints

Press to raise or lower the rear portion of the seat cushion.

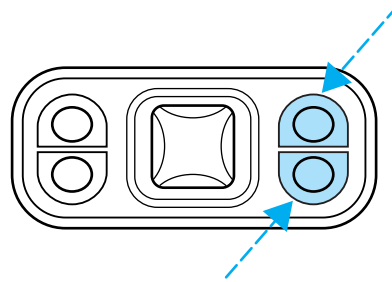

Press the control to move the seat forward, backward, up or down.

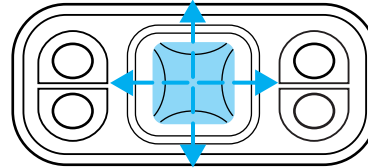

### Quick release captains chair

#### To remove the seat:

1. Disengage the lap/shoulder belt from the seat by inserting a key or small screwdriver into the slot in the detachable anchor and lifting upward.

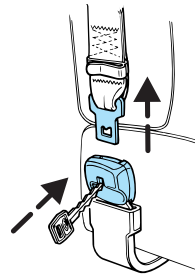

## Seating and Safety Restraints

Stow the tongue end of the detachable anchor.

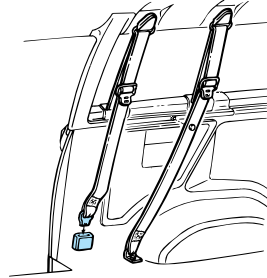

2. Pull the seat latch handle, then pull the seat toward the right side of the vehicle to disengage four pins from the floor mount.

3. Remove the seat.

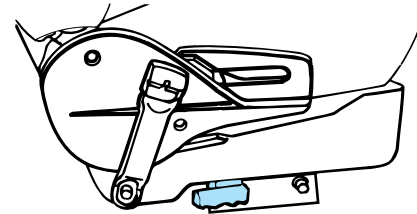

### To install the seat:

 Check to see that the seat and seatback is latched securely in position. Keep floor area free of objects that would prevent proper seat engagement. Never attempt to adjust the seat while the vehicle is in motion.

1. Position the seat to the floor mount.

2. Engage the four pins into the floor mount hole and push the seat toward the left side of the vehicle to fully engage.

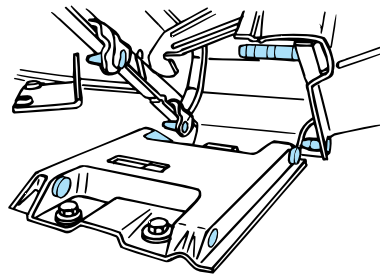

3. Pull the seat latch handle downward to lock the seat in position.

4. Make sure the safety belt is not twisted, then insert the seat belt tongue into detachable anchor until you hear a “click” and feel the latch engage.

## Seating and Safety Restraints

### ACCESSING THE 3RD, 4TH AND 5TH ROW SEATS (IF EQUIPPED)

To make access to the 4th and 5th row seats easier, attach the 3rd and 4th row passenger side seat belts to the trim panel by using the snaps attached to the seat belt webbing and the trim panel.

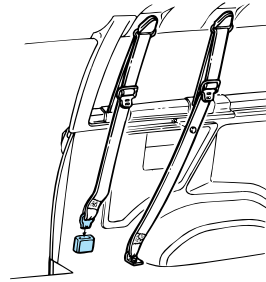

### REAR BENCH SEAT

#### To remove the seats:

1. Disengage the lap/shoulder belt from the seat by inserting a key or small screwdriver into the slot in the detachable anchor and lifting upward (2nd row passenger side only).

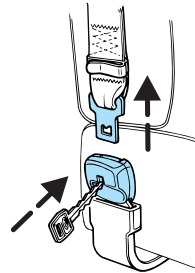

Stow the tongue end of the detachable anchor (2nd row only).

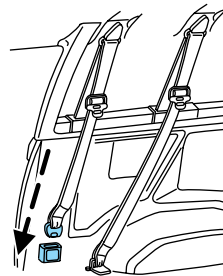

## Seating and Safety Restraints

2. Pull the LH/RH seat latch handles, located under the seat, rearward to release the latch hook ends from the front strikers.

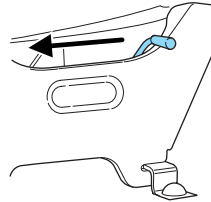

3. Move the seat rearward and lift the seats rear hooks away from the rear strikers prior to lifting the front hooks out from the front strikers.

4. With assistance, remove the seat assembly.

- To remove the 3rd, 4th, and 5th row seats (if equipped), repeat steps 2 through 4.

### To install the seat:

1. Position the seat in the vehicle.

2. Align front hooks to front strikers, prior to lowering the rear hooks and aligning them with the rear strikers.

3. Engage the LH/RH latch rod hook ends in the front striker locking holes.

4. Rotate the LH/RH latch handles forward, and at the same time slide the seat assembly forward to engage the strikers. Continue forward movement until the seat reaches the end of its travel.

5. Make sure the safety belt is not twisted, then insert the seat belt tongue into detachable anchor until you hear a “click” and feel the latch engage (2nd row only).



Always latch the vehicle seat to the floor, whether the seat is occupied or empty. If not latched, the seat may cause injury during a sudden stop.

## SAFETY RESTRAINTS

### Safety restraints precautions



Always drive and ride with your seatback upright and the lap belt snug and low across the hips.



## Seating and Safety Restraints



To reduce the risk of injury, make sure children sit where they can be properly restrained.



Never let a passenger hold a child on his or her lap while the vehicle is moving. The passenger cannot protect the child from injury in a collision.



All occupants of the vehicle, including the driver, should always properly wear their safety belts, even when an air bag (SRS) is provided.



It is extremely dangerous to ride in a cargo area, inside or outside of a vehicle. In a collision, people riding in these areas are more likely to be seriously injured or killed. Do not allow people to ride in any area of your vehicle that is not equipped with seats and safety belts. Be sure everyone in your vehicle is in a seat and using a safety belt properly.



In a rollover crash, an unbelted person is significantly more likely to die than a person wearing a safety belt.



Each seating position in your vehicle has a specific safety belt assembly which is made up of one buckle and one tongue that are designed to be used as a pair. 1) Use the shoulder belt on the outside shoulder only. Never wear the shoulder belt under the arm. 2) Never swing the safety belt around your neck over the inside shoulder. 3) Never use a single belt for more than one person.



Always transport children 12 years old and under in the back seat and always properly use appropriate child restraints.



Safety belts and seats can become hot in a vehicle that has been closed up in sunny weather; they could burn a small child. Check seat covers and buckles before you place a child anywhere near them.

## Seating and Safety Restraints

### Combination lap and shoulder belts

1. Insert the belt tongue into the proper buckle (the buckle closest to the direction the tongue is coming from) until you hear a snap and feel it latch. Make sure the tongue is securely fastened in the buckle.

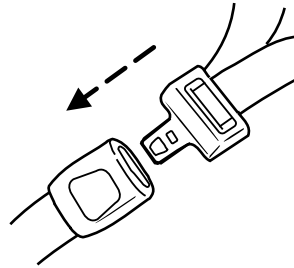

2. To unfasten, push the release button and remove the tongue from the buckle.

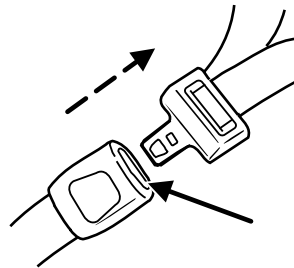

The front and rear outboard safety restraints in the vehicle are combination lap and shoulder belts. The front passenger and rear seat outboard safety belts have two types of locking modes described below:

### Vehicle sensitive mode

This is the normal retractor mode, which allows free shoulder belt length adjustment to your movements and locking in response to vehicle movement. For example, if the driver brakes suddenly or turns a corner sharply, or the vehicle receives an impact of approximately 8 km/h (5 mph) or more, the combination safety belts will lock to help reduce forward movement of the driver and passengers.

### Automatic locking mode

The automatic locking mode is not available on the driver safety belt.

## Seating and Safety Restraints

### ***When to use the automatic locking mode***

In this mode, the shoulder belt is automatically pre-locked. The belt will still retract to remove any slack in the shoulder belt. The automatic locking mode is not available on the driver safety belt.

This mode should be used **any time** a child safety seat is installed in a passenger front or outboard rear seating position (if equipped). Children 12 years old and under should be properly restrained in the rear seat whenever possible. Refer to *Safety restraints for children* or *Safety seats for children* later in this chapter.

### ***How to use the automatic locking mode***

- Buckle the combination lap and shoulder belt.

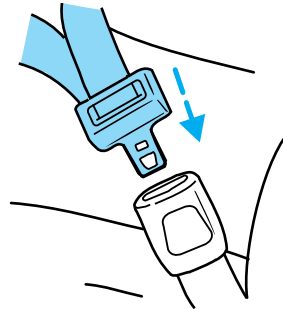

- Grasp the shoulder portion and pull downward until the entire belt is pulled out.

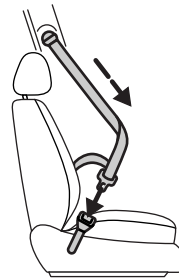



- Allow the belt to retract. As the belt retracts, you will hear a clicking sound. This indicates the safety belt is now in the automatic locking mode.

## Seating and Safety Restraints

### ***How to disengage the automatic locking mode***

Disconnect the combination lap/shoulder belt and allow it to retract completely to disengage the automatic locking mode and activate the vehicle sensitive (emergency) locking mode.

 After any vehicle collision, the safety belt systems at all outboard seating positions (except the driver position, which does not have this feature) must be checked by a qualified technician to verify that the automatic locking retractor feature for child seats is still functioning properly. In addition, all seat belts should be checked for proper function.

 BELT AND RETRACTOR ASSEMBLY MUST BE REPLACED if the seat belt assembly “automatic locking retractor” feature or any other seat belt function is not operating properly when checked according to the procedures in Workshop Manual. Failure to replace the Belt and Retractor assembly could increase the risk of injury in collisions.

### **Safety belt pretensioner**

Your vehicle is equipped with safety belt pretensioners at the driver and front passenger seating positions.

The safety belt pretensioner is a device which removes excess webbing from the safety belt system. The safety belt pretensioner uses the same crash sensor system as the front air bag supplemental restraint system (SRS). When the safety belt pretensioner deploys, webbing from the lap and shoulder belt is tightened. The driver and front passenger seat belt system (including retractors, buckles and height adjusters) must be replaced if the vehicle is involved in a collision that results in deployment of front air bags and safety belt pretensioners. Refer to the *Safety belt maintenance* section in this chapter.

 Failure to replace the safety belt assembly under the above conditions could result in severe personal injuries in the event of a collision.

## Seating and Safety Restraints

### Front safety belt height adjustment

Adjust the height of the shoulder belt so the belt rests across the middle of your shoulder.

To adjust the shoulder belt height, push the button and slide the height adjuster up or down. Release the button and pull down on the height adjuster to make sure it is locked in place.

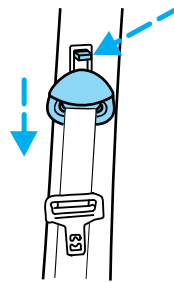

 Position the safety belt height adjusters so that the belt rests across the middle of your shoulder. Failure to adjust the safety belt properly could reduce the effectiveness of the seat belt and increase the risk of injury in a collision.

### Lap belts

#### *Adjusting the center lap belt*

The lap belt does not adjust automatically.

 The lap belt should fit snugly and as low as possible around the hips, not across the waist.

Insert the tongue into the correct buckle (the buckle closest to the direction the tongue is coming from). To lengthen the belt, turn the tongue at a right angle to the belt and pull across your lap until it reaches the buckle. To tighten the belt, pull the loose end of the belt through the tongue until it fits snugly across the hips.

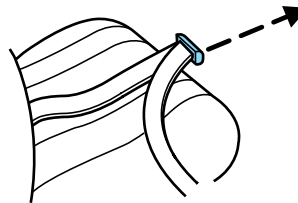

## Seating and Safety Restraints

Shorten and fasten the belt when not in use.

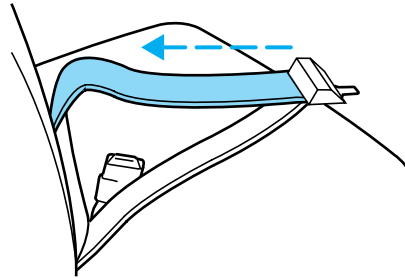

### Safety belt warning light and indicator chime

The safety belt warning light illuminates in the instrument cluster and a chime sounds to remind the occupants to fasten their safety belts.

#### Conditions of operation

If...	Then...
The driver's safety belt is not buckled before the ignition switch is turned to the ON position...	The safety belt warning light illuminates and the warning chime sounds 4-8 seconds.
The driver's safety belt is buckled while the indicator light is illuminated and the warning chime is sounding...	The safety belt warning light and warning chime turn off.
The driver's safety belt is buckled before the ignition switch is turned to the ON position...	The indicator chime will remain off and the safety belt warning lamp will illuminate for 4-8 seconds.

### BeltMinder

The BeltMinder feature is a supplemental warning to the safety belt warning function. This feature provides additional reminders to the driver that the driver's safety belt is unbuckled by intermittently sounding a chime and illuminating the safety belt warning lamp in the instrument cluster.

## Seating and Safety Restraints

If...	Then...
The driver's safety belt is not buckled approximately 5 seconds after the safety belt warning light has turned off...	The BeltMinder feature is activated - the safety belt warning light illuminates and the warning chime sounds for 6 seconds every 30 seconds, repeating for approximately 5 minutes or until safety belt is buckled.
The driver's safety belt is buckled while the safety belt indicator light is illuminated and the safety belt warning chime is sounding...	The BeltMinder feature will not activate.
The driver's safety belt is buckled before the ignition switch is turned to the ON position...	The BeltMinder feature will not activate.

The following are reasons most often given for not wearing safety belts:  
(All statistics based on U.S. data)

Reasons given...	Consider...
"Crashes are rare events"	<b>36700 crashes occur every day.</b> The more we drive, the more we are exposed to "rare" events, even for good drivers. <i>1 in 4 of us will be seriously injured in a crash during our lifetime.</i>
"I'm not going far"	<b>3 of 4</b> fatal crashes occur within <b>25</b> miles of home.
"Belts are uncomfortable"	We design our safety belts to enhance comfort. If you are uncomfortable - try different positions for the safety belt upper anchorage and seatback which should be as upright as possible; this can improve comfort.

## Seating and Safety Restraints

Reasons given...	Consider...
"I was in a hurry"	<b>Prime time for an accident.</b> BeltMinder reminds us to take a few seconds to buckle up.
"Seat belts don't work"	<b>Safety belts</b> , when used properly, <b>reduce risk of death</b> to front seat occupants by <b>45% in cars</b> , and by <b>60% in light trucks</b> .
"Traffic is light"	<b>Nearly 1 of 2 deaths occur in single-vehicle crashes</b> , many when no other vehicles are around.
"Belts wrinkle my clothes"	Possibly, but a serious crash can do much more than wrinkle your clothes, particularly if you are unbelted.
"The people I'm with don't wear belts"	Set the example, teen deaths occur 4 times more often in vehicles with TWO or MORE people. Children and younger brothers/sisters imitate behavior they see.
"I have an air bag"	Air bags offer greater protection when used with safety belts. Frontal airbags are not designed to inflate in rear and side crashes or rollovers.
"I'd rather be thrown clear"	<b>People who are ejected are 40 times more likely to DIE.</b> Safety belts help prevent ejection, WE CAN'T "PICK OUR CRASH".

 Do not sit on top of a buckled safety belt to avoid the Belt Minder chime. Sitting on the safety belt will increase the risk of injury in an accident. To disable (one-time) or deactivate the Belt Minder feature please follow the directions stated below.

### **One time disable**

Any time the safety belt is buckled and then unbuckled during an ignition ON cycle, BeltMinder will be disabled for that ignition cycle only.



## Seating and Safety Restraints

### ***Deactivating/activating the BeltMinder feature***

*Read steps 1 - 9 thoroughly before proceeding with the deactivation/activation programming procedure.*

The BeltMinder feature can be deactivated/activated by performing the following procedure:

Before following the procedure, make sure that:

- the parking brake is set
- the gearshift is in P (Park) (automatic transmission)
- the ignition switch is in the OFF position
- all vehicle doors are closed
- the driver's safety belt is unbuckled
- the parklamps/headlamps are in OFF position (If vehicle is equipped with Autolamps, this will not affect the procedure.)



To reduce the risk of injury, do not deactivate/activate the Belt Minder feature while driving the vehicle.

1. Turn the ignition switch to the RUN (or ON) position. (DO NOT START THE ENGINE)
2. Wait at least one minute after the safety belt warning light turns off.
  - Steps 3–5 must be completed within 60 seconds or the procedure will have to be repeated.
3. Buckle then unbuckle the safety belt three times, ending with the safety belt unbuckled. This can be done before or during BeltMinder warning activation.
4. Turn on the parklamps/headlamps, turn off the parklamps/headlamps.
5. Buckle then unbuckle the safety belt three times, ending with the safety belt unbuckled.
  - After step 5 the safety belt warning light will be turned on for three seconds.
6. Within seven seconds of the safety belt warning light turning off, buckle then unbuckle the safety belt.
  - This will disable BeltMinder if it is currently enabled, or enable BeltMinder if it is currently disabled.
7. Confirmation of disabling BeltMinder is provided by flashing the safety belt warning light four times per second for three seconds.

## Seating and Safety Restraints

8. Confirmation of enabling BeltMinder is provided by flashing the safety belt warning light four times per second for three seconds, followed by three seconds with the safety belt warning light off, then followed by flashing the safety belt warning light four times per second for three seconds again.
9. After receiving confirmation, the deactivation/activation procedure is complete.

### Safety belt extension assembly

If the safety belt is too short when fully extended, there is a 20 cm (8 inch) safety belt extension assembly that can be added (part number 611C22). This assembly can be obtained from your dealer at no cost.

Use only extensions manufactured by the same supplier as the safety belt. Manufacturer identification is located at the end of the webbing on the label. Also, use the safety belt extension only if the safety belt is too short for you when fully extended.



Do not use extensions to change the fit of the shoulder belt across the torso.

### Safety belt maintenance

Inspect the safety belt systems periodically to make sure they work properly and are not damaged. Inspect the safety belts to make sure there are no nicks, tears or cuts. Replace if necessary. All safety belt assemblies, including retractors, buckles, front seat belt buckle assemblies, buckle support assemblies (slide bar-if equipped), shoulder belt height adjusters (if equipped), shoulder belt guide on seatback (if equipped), child safety seat LATCH and tether anchors, and attaching hardware, should be inspected after a collision. Ford Motor Company recommends that all safety belt assemblies used in vehicles involved in a collision be replaced. However, if the collision was minor and a qualified technician finds that the belts do not show damage and continue to operate properly, they do not need to be replaced. Safety belt assemblies not in use during a collision should also be inspected and replaced if either damage or improper operation is noted.



Failure to inspect and if necessary replace the safety belt assembly under the above conditions could result in severe personal injuries in the event of a collision.

Refer to *Interior* in the *Cleaning* chapter.

## Seating and Safety Restraints

### AIR BAG SUPPLEMENTAL RESTRAINT SYSTEM (SRS)

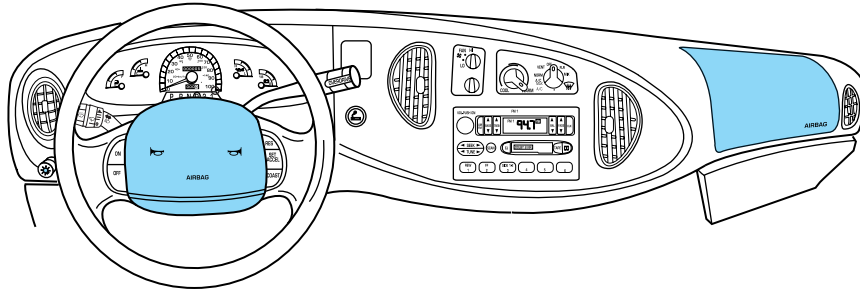

#### Important SRS precautions

The SRS is designed to work with the safety belt to help protect the driver and right front passenger from certain upper body injuries. Air bags DO NOT inflate slowly; there is a risk of injury from a deploying air bag.

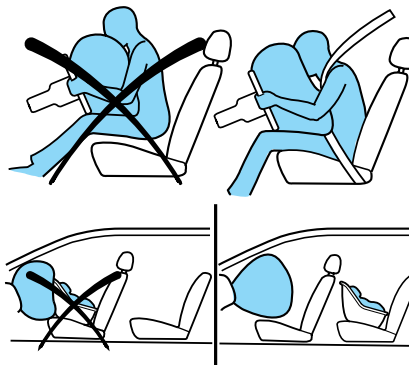

All occupants of the vehicle, including the driver, should always properly wear their safety belts, even when an air bag (SRS) is provided.



Always transport children 12 years old and under in the back seat and always properly use appropriate child restraints.

## Seating and Safety Restraints



The National Highway Traffic Safety Administration (NHTSA) recommends a minimum distance of at least 25 cm (10 inches) between an occupant's chest and the driver air bag module.



Never place your arm over the air bag module as a deploying air bag can result in serious arm fractures or other injuries.

To properly position yourself away from the air bag:

- Move your seat to the rear as far as you can while still reaching the pedals comfortably.
- Recline the seat slightly one or two degrees from the upright position.



Do not put anything on or over the air bag module. Placing objects on or over the air bag inflation area may cause those objects to be propelled by the air bag into your face and torso causing serious injury.



Do not attempt to service, repair, or modify the air bag supplemental restraint systems or its fuses. See your Ford or Lincoln Mercury dealer.



Modifying or adding equipment to the front end of the vehicle (including frame, bumper, front end body structure and tow hooks) may affect the performance of the air bag system, increasing the risk of injury. Do not modify the front end of the vehicle.



Additional equipment may affect the performance of the air bag sensors increasing the risk of injury. Please refer to the Body Builders Layout Book for instructions about the appropriate installation of additional equipment.

## Seating and Safety Restraints

### Children and air bags

Children must always be properly restrained. Accident statistics suggest that children are safer when properly restrained in the rear seating positions than in the front seating position. Failure to follow these instructions may increase the risk of injury in a collision.

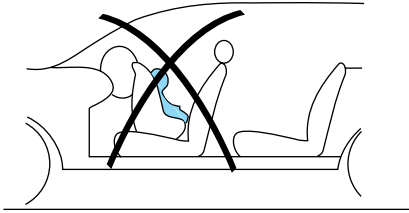

Air bags can kill or injure a child in a child seat.

**NEVER** place a rear-facing child seat in front of an active air bag. If you must use a forward-facing child seat in the front seat, move the seat all the way back.

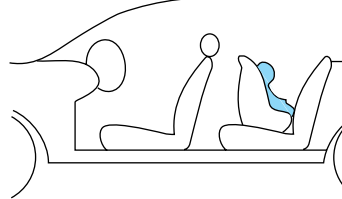

### How does the air bag supplemental restraint system work?

The air bag SRS is designed to activate when the vehicle sustains a longitudinal deceleration sufficient to cause the air bag sensors to close an electrical circuit that initiates air bag inflation. The fact that the air bags did not inflate in a collision does not mean that something is wrong with the system. Rather, it means the forces were not sufficient enough to cause activation. Air bags are designed to inflate in frontal and near-frontal collisions, not rollover, side-impact, or rear-impacts unless the collision causes sufficient longitudinal deceleration.

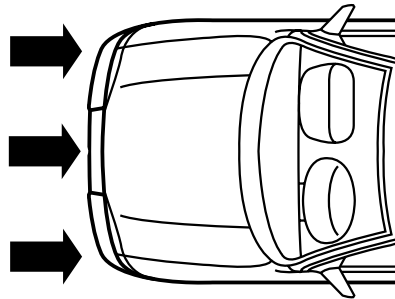

## Seating and Safety Restraints

The air bags inflate and deflate rapidly upon activation. After air bag deployment, it is normal to notice a smoke-like, powdery residue or smell the burnt propellant. This may consist of cornstarch, talcum powder or sodium compounds which may irritate the skin and eyes, but none of the residue is toxic.



While the SRS is designed to help reduce serious injuries, contact with a deploying air bag may also cause abrasions, swelling or temporary hearing loss. Because air bags must inflate rapidly and with considerable force, there is the risk of death or serious injuries such as fractures, facial and eye injuries or internal injuries, particularly to occupants who are not properly restrained or are otherwise out of position at the time of air bag deployment. It is extremely important that occupants be properly restrained as far away from the air bag module as possible while maintaining vehicle control.

The SRS consists of:

- driver and passenger air bag modules (which include the inflators and air bags)
- one or more impact and safing sensors
- a readiness light and tone
- a diagnostic module
- and the electrical wiring which connects the components

The diagnostic module monitors its own internal circuits and the supplemental air bag electrical system warning (including the impact sensors), the system wiring, the air bag system readiness light, the air bag back up power and the air bag ignitors.



Several air bag system components get hot after inflation. Do not touch them after inflation.



If the air bag has deployed, **the air bag will not function again and must be replaced immediately.** If the air bag is not replaced, the unrepaired area will increase the risk of injury in a collision.

## Seating and Safety Restraints

### Determining if the system is operational

The SRS uses a readiness light in the instrument cluster or a tone to indicate the condition of the system. Refer to *Air bag readiness* section in the *Instrument cluster* chapter. Routine maintenance of the air bag is not required.

A difficulty with the system is indicated by one or more of the following:

- The readiness light will either flash or stay lit.
- The readiness light will not illuminate immediately after ignition is turned on.
- A series of five beeps will be heard. The tone pattern will repeat periodically until the problem and/or light are repaired.



If any of these things happen, even intermittently, have the SRS serviced at your dealership or by a qualified technician immediately. Unless serviced, the system may not function properly in the event of a collision.

### Disposal of air bags and air bag equipped vehicles (including pretensioners)

See your local dealership or qualified technician. Air bags **MUST BE** disposed of by qualified personnel.

### SAFETY RESTRAINTS FOR CHILDREN

See the following sections for directions on how to properly use safety restraints for children. Also see *Air bag supplemental restraint system (SRS)* in this chapter for special instructions about using air bags.

#### Important child restraint precautions

You are required by law to use safety restraints for children in the U.S. and Canada. If small children ride in your vehicle (generally children who are four years old or younger and who weigh 18 kg [40 lbs] or less), you must put them in safety seats made especially for children. Check your local and state or provincial laws for specific requirements regarding the safety of children in your vehicle. When possible, always place children under age 12 in the rear seat of your vehicle. Accident statistics suggest that children are safer when properly restrained in the rear seating positions than in the front seating position.

## Seating and Safety Restraints



Never let a passenger hold a child on his or her lap while the vehicle is moving. The passenger cannot protect the child from injury in a collision.

Always follow the instructions and warnings that come with any infant or child restraint you might use.

Ford recommends using child safety seats equipped with LATCH attachments, attached to LATCH anchors and tether anchors. Some child seat manufacturers sell LATCH accessory belts that attach child seats that are not equipped with LATCH attachments onto LATCH anchors. See *Attaching safety seats with LATCH attachments for child seat anchors* in this section for seating positions with LATCH anchors.

If you install a forward-facing child safety seat using the vehicle safety belts:

- use only seats equipped with lap-shoulder belts;
- forward-facing child safety seats can be used in the center of the three-passenger 2nd row bench seat only if a top tether strap is used;
- Ford recommends placing forward-facing safety seats in the 2nd row and using top tether straps for added protection.

For more information on top tether straps, see *Attaching safety seats with tether straps* in this section.

Any booster seat that places the vehicle's lap belt or shoulder belt around a shield above and ahead of the child's hips should not be used in this vehicle.



**Do not** use a forward-facing safety seat or an infant seat in the last row of a 12- or 15-passenger Club Wagon.

### Children and safety belts

If the child is the proper size, restrain the child in a safety seat. Children who are too large for child safety seats (as specified by your child safety seat manufacturer) should always wear safety belts.

Follow all the important safety restraint and air bag precautions that apply to adult passengers in your vehicle.

If the shoulder belt portion of a combination lap and shoulder belt can be positioned so it does not cross or rest in front of the child's face or neck, the child should wear the lap and shoulder belt. Moving the child closer to the center of the vehicle may help provide a good shoulder belt fit.



## Seating and Safety Restraints



Do not leave children, unreliable adults, or pets unattended in your vehicle.

### **Child booster seats**

Children outgrow a typical convertible or toddler seat when they weigh 40 pounds and are around 4 years of age. Although the lap/shoulder belt will provide some protection, these children are still too small for lap/shoulder belts to fit properly, which could increase the risk of serious injury.

To improve the fit of both the lap and shoulder belt on children who have outgrown child safety seats, Ford Motor Company recommends use of a belt-positioning booster.

Booster seats position a child so that safety belts fit better. They lift the child up so that the lap belt rests low across the hips and the knees bend comfortably. Booster seats also make the shoulder belt fit better and more comfortably for growing children.

### **When children should use booster seats**

Children need to use booster seats from the time they outgrow the toddler seat until they are big enough for the vehicle seat and lap/shoulder belt to fit properly. Generally this is when they weigh about 80 lbs (about 8 to 12 years old).

Booster seats should be used until you can answer YES to ALL of these questions:

- Can the child sit all the way back against the vehicle seat back with knees bent comfortably at the edge of the seat without slouching?

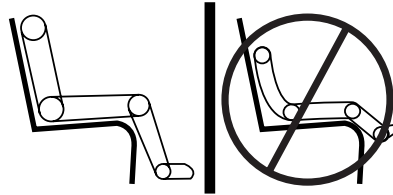

- Does the lap belt rest low across the hips?
- Is the shoulder belt centered on the shoulder and chest?
- Can the child stay seated like this for the whole trip?

## Seating and Safety Restraints

### **Types of booster seats**

There are two types of belt-positioning booster seats:

- Those that are backless.

If your backless booster seat has a removable shield, remove the shield and use the lap/shoulder belt. If a seating position has a low seat back and no head restraint, a backless booster seat may place your child's head (top of ear level) above the top of the seat. In this case, move the backless booster to another seating position with a higher seat back and lap/shoulder belts.



- Those with a high back.

If, with a backless booster seat, you cannot find a seating position that adequately supports your child's head, a high back booster seat would be a better choice.



Both can be used in any vehicle in a seating position equipped with lap/shoulder belts if your child is over 40 lbs.

The shoulder belt should cross the chest, resting snugly on the center of the shoulder. The lap belt should rest low and snug across the hips, never up high across the stomach.

If the booster seat slides on the vehicle seat, placing a rubberized mesh sold as shelf or carpet liner under the booster seat may improve this condition.

## Seating and Safety Restraints

### The importance of shoulder belts

Using a booster without a shoulder belt increases the risk of a child's head hitting a hard surface in a collision. For this reason, you should never use a booster seat with a lap belt only. It is best to use a booster seat with lap/shoulder belts in the back seat- the safest place for children to ride.



Follow all instructions provided by the manufacturer of the booster seat.



Never put the shoulder belt under a child's arm or behind the back because it eliminates the protection for the upper part of the body and may increase the risk of injury or death in a collision.



Never use pillows, books, or towels to boost a child. They can slide around and increase the likelihood of injury or death in a collision.

### SAFETY SEATS FOR CHILDREN



#### Child and infant or child safety seats

Use a safety seat that is recommended for the size and weight of the child. Carefully follow all of the manufacturer's instructions with the safety seat you put in your vehicle. If you do not install and use the safety seat properly, the child may be injured in a sudden stop or collision.

## Seating and Safety Restraints

When installing a child safety seat:

- Review and follow the information presented in the *Air Bag Supplemental Restraint System* section in this chapter.
- Use the correct safety belt buckle for that seating position (the buckle closest to the direction the tongue is coming from).
- Insert the belt tongue into the proper buckle until you hear a snap and feel it latch. Make sure the tongue is securely fastened in the buckle.
- For the front passenger seat, keep the buckle release button pointing up and away from the safety seat, with the tongue between the child seat and the release button, to prevent accidental unbuckling.
- For the front passenger seat, place seat back in upright position.
- Put the safety belt in the automatic locking mode. Refer to *Automatic locking mode* (passenger side front and outboard rear seating positions) (if equipped).

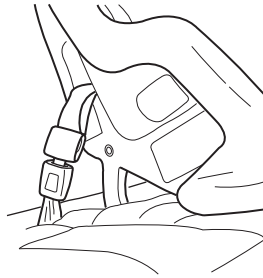

Ford recommends the use of a child safety seat having a top tether strap. Install the child safety seat in a seating position which is capable of providing a tether anchorage. For more information on top tether straps, refer to *Attaching safety seats with tether straps*.



Carefully follow all of the manufacturer's instructions included with the safety seat you put in your vehicle. If you do not install and use the safety seat properly, the child may be injured in a sudden stop or collision.

## Seating and Safety Restraints

### Installing child safety seats with combination lap and shoulder belts

1. Position the child safety seat in a seat with a combination lap and shoulder belt.

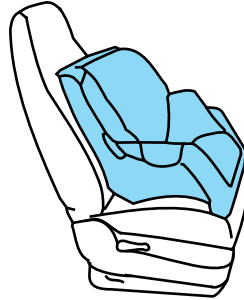

An air bag can kill or injure a child in a child seat. If you must use a forward-facing child seat in the front seat, move seat all the way back.



Children 12 and under should be properly restrained in the rear seat whenever possible.

2. Pull down on the shoulder belt and then grasp the shoulder belt and lap belt together.

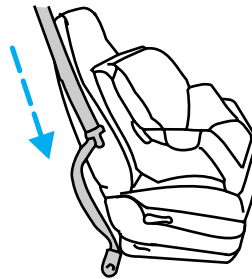

## Seating and Safety Restraints

3. While holding the shoulder and lap belt portions together, route the tongue through the child seat according to the child seat manufacturer's instructions. Be sure the belt webbing is not twisted.

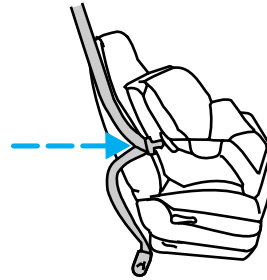

4. Insert the belt tongue into the proper buckle (the buckle closest to the direction the tongue is coming from) for that seating position until you hear a snap and feel the latch engage. Make sure the tongue is latched securely by pulling on it.

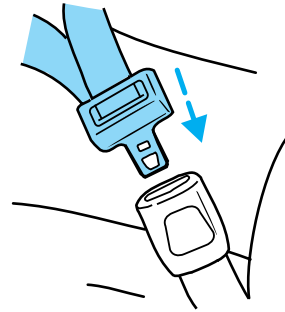

5. To put the retractor in the automatic locking mode, grasp the shoulder portion of the belt and pull downward until all of the belt is extracted.

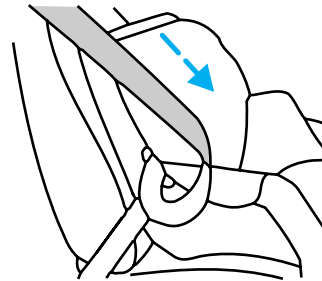

6. Allow the belt to retract. The belt will click as it retracts to indicate it is in the automatic locking mode.

## Seating and Safety Restraints

7. Pull the lap belt portion across the child seat toward the buckle and pull up on the shoulder belt while pushing down with your knee on the child seat.

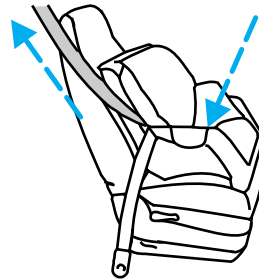

8. Allow the safety belt to retract to remove any slack in the belt.

9. Before placing the child in the seat, forcibly tilt the seat forward and back to make sure the seat is securely held in place. To check this, grab the seat at the belt path and attempt to move it side to side and forward and back. There should be no more than one inch of movement for proper installation.

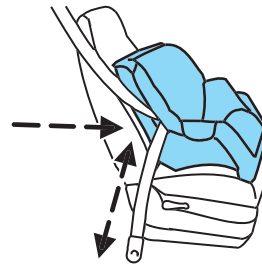

10. Try to pull the belt out of the retractor to make sure the retractor is in the automatic locking mode (you should not be able to pull more belt out). If the retractor is not locked, unbuckle the belt and repeat steps two through nine.

Check to make sure the child seat is properly secured before each use.

### Attaching safety seats with tether straps



Children should be placed in the rear in an appropriate child safety seat that is properly secured to the vehicle.



When using forward-facing child safety seats in vehicles with only two seating positions so the forward-facing child safety seat cannot be placed in the rear of the vehicle, move the passenger seat as far back from the instrument panel as possible.



**Do not** use a forward-facing safety seat or an infant seat in the last row of a 12- or 15-passenger Club Wagon.

## Seating and Safety Restraints

 Air bags can kill or injure a child in a child seat. **NEVER** place a rear-facing child seat in front of an active air bag. If you must use a forward-facing child seat in the front seat, move the seat all the way back.

### **Front passenger seating position**

The tether can be attached directly to the rear of the front seat.

1. Position the child safety seat on the front right-hand passenger seat.
2. Adjust the front right-hand passenger seat full forward.

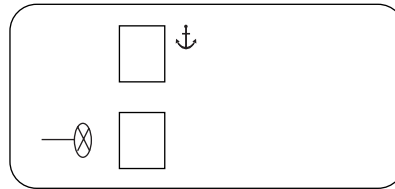

3. Route the child safety seat tether strap over the back of the front right-hand passenger seat as shown.

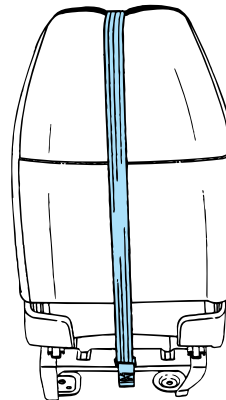
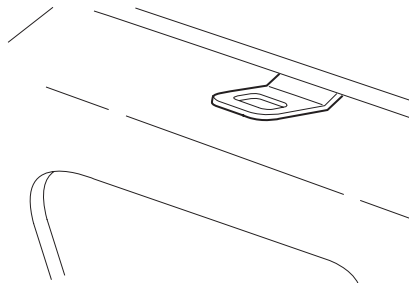



## Seating and Safety Restraints

4. Clip the tether strap hook to the seat pedestal to the location shown.

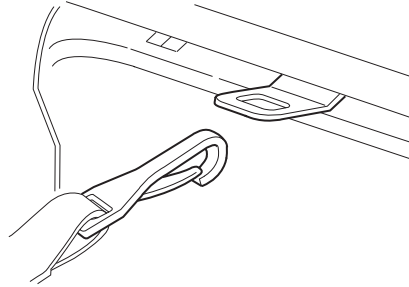

5. Adjust the front right hand passenger seat to the full rearward position.

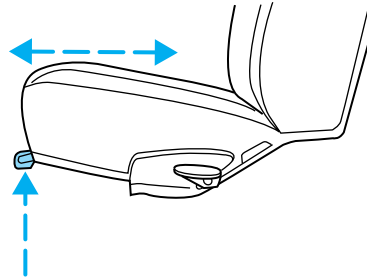

6. Refer to the instructions in this section under *Installing child safety seats in combination lap and shoulder belt seating positions* to secure the child safety seat.

7. Tighten the child safety seat tether strap according to the manufacturer's instructions.

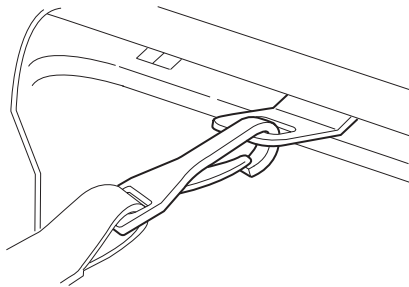

## Seating and Safety Restraints

### **Second row bucket seats (Chateau Quads)**

The tether strap can be attached directly to the tether bracket under the back edge of the seat cushion.

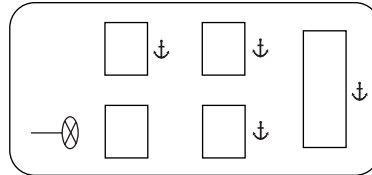

1. Position the child safety seat on the second row left hand or right hand bucket seat.
2. Route the child safety tether strap over the back of the left hand or right hand second row bucket seat.

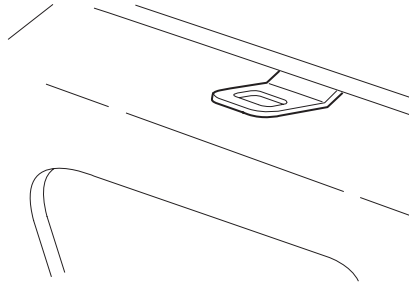

3. Clip the tether strap hook to the seat pedestal at the location shown.

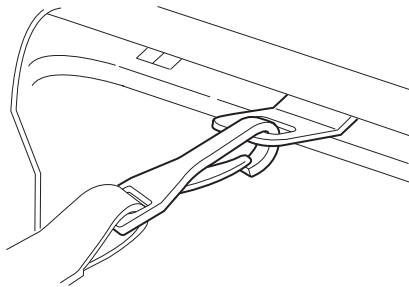

4. Refer to the instructions in this section under *Installing child safety seats in combination lap and shoulder belt seating positions* to secure the child safety seat.
5. Tighten the child safety seat tether strap according to the manufacturer's instructions.

## Seating and Safety Restraints

### **Second, Third and Fourth row three passenger bench seats**

The tether strap can be attached directly to the tether bracket provided under the back edge of the seat cushion.

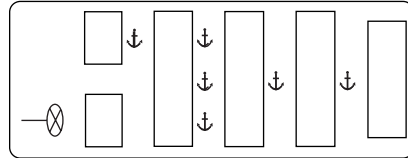

1. For second row 3-Passenger bench seat, place the child safety seat on the left hand outboard position, the center position, or the right hand outboard position as desired.

For third row or fourth row 3-Passenger bench seat, place the child safety seat on the center position.

2. Route the child safety tether strap over the back of 3-Passenger bench seat.

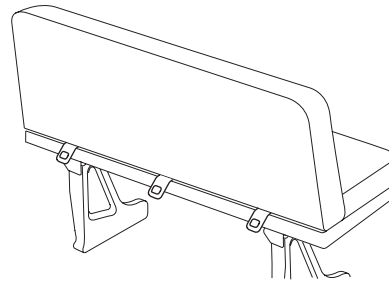

3. Clip the tether strap hook to the tether bracket mounted under rear rail of seat cushion frame.

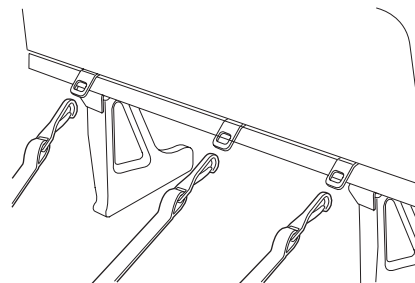

4. Refer to the instructions in this section under *installing child safety seats in combination lap and shoulder belt seating positions* to secure the child safety seat.

## Seating and Safety Restraints

5. Tighten the child safety seat tether strap according to the manufacturer's instructions.

For additional important safety information on the proper use of seat belts, child seats and infant seats, please read the entire *Seating and Safety Restraints* chapter in this Owner's Guide.

### **Attaching safety seats with LATCH (Lower Anchors and Tethers for Children) attachments for child seat anchors**

Some child safety seats have two rigid or webbing mounted attachments that connect to two anchors at certain seating positions in your vehicle. This type of child seat eliminates the need to use seat belts to attach the child seat. For forward-facing child seats, the tether strap must also be attached to the proper tether anchor. See *Attaching safety seats with tether straps* in this chapter.

Your vehicle may be equipped with LATCH anchors for child seat installation at the seating positions marked with the child seat symbol:

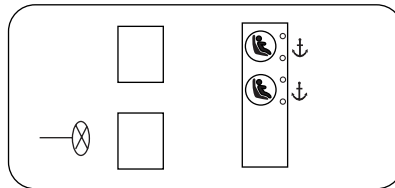

- Five passenger crew van

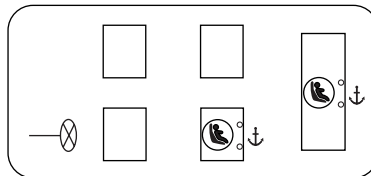

- Seven passenger wagon

## Seating and Safety Restraints

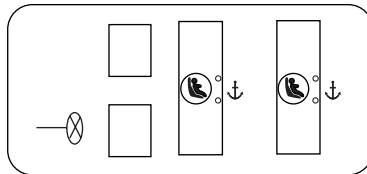

- Eight passenger wagon

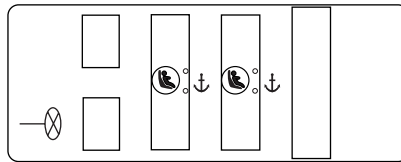

- Twelve passenger wagon

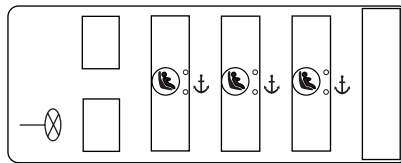

- Fifteen passenger wagon

 represents LATCH anchors.

 represents tether strap anchors.



Never attach two LATCH child safety seats to the same anchor. In a crash, one anchor may not be strong enough to hold two child safety seat attachments and may break, causing serious injury or death.

## Seating and Safety Restraints

The lower anchors for child seat installation are located at the rear section of the seat between the cushion and seat back.

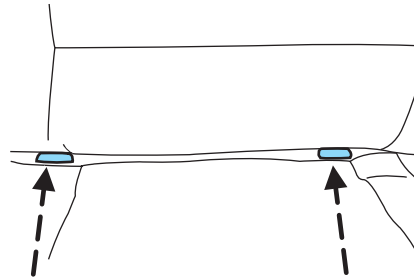

Follow the child seat manufacturer's instructions to properly install a child seat with LATCH attachments.



Attach LATCH lower attachments of the child seat only to the anchors shown.

If you install a child seat with rigid LATCH attachments, do not tighten the tether strap enough to lift the child seat off the vehicle seat cushion when the child is seated in it. Keep the tether strap just snug without lifting the front of the child seat. Keeping the child seat just touching the vehicle seat gives the best protection in a severe crash.

Each time you use the safety seat, check that the seat is properly attached to the lower anchors and tether anchor. Try to tilt the child seat from side to side. Also try to tug the seat forward. Check to see if the anchors hold the seat in place.





If the safety seat is not anchored properly, the risk of a child being injured in a crash greatly increases.

### STARTING

#### Positions of the ignition

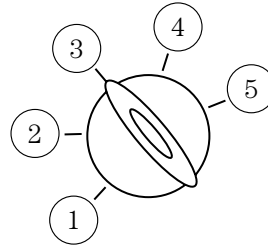
1. ACCESSORY, allows the electrical accessories such as the radio to operate while the engine is not running.
2. LOCK, locks the automatic transmission gearshift lever and allows key removal.
3. OFF, shuts off the engine and all accessories without locking the steering wheel. This position also allows the automatic transmission shift lever to be moved from the P (Park) position without the brake pedal being depressed.



 In the ignition OFF position, the automatic transmission shift lever can be moved from the P (Park) position without the brake pedal depressed. To avoid unwanted vehicle movement, always set the parking brake.

4. ON, all electrical circuits operational. Warning lights illuminated. Key position when driving.
5. START, cranks the engine. Release the key as soon as the engine starts.

#### Preparing to start your vehicle

Engine starting is controlled by the powertrain control system. This system meets all Canadian Interference-Causing Equipment standard requirements regulating the impulse electrical field strength of radio noise.

When starting a fuel-injected engine, don't press the accelerator before or during starting. Only use the accelerator when you have difficulty starting the engine. For more information on starting the vehicle, refer to *Starting the engine* in this chapter.

 Extended idling at high engine speeds can produce very high temperatures in the engine and exhaust system, creating the risk of fire or other damage.

## Driving

 Do not park, idle, or drive your vehicle in dry grass or other dry ground cover. The emission system heats up the engine compartment and exhaust system, which can start a fire.

 Do not start your vehicle in a closed garage or in other enclosed areas. Exhaust fumes can be toxic. Always open the garage door before you start the engine. See *Guarding against exhaust fumes* in this chapter for more instructions.

 If you smell exhaust fumes inside your vehicle, have your dealer inspect your vehicle immediately. Do not drive if you smell exhaust fumes.

### **Important safety precautions**

When the engine starts, the idle RPM runs faster to warm the engine. If the engine idle speed does not slow down automatically, have the vehicle checked.

Before starting the vehicle:

1. Make sure all occupants buckle their safety belts. For more information on safety belts and their proper usage, refer to the *Seating and safety restraints* chapter.
2. Make sure the headlamps and electrical accessories are off.
  - Make sure the parking brake is set.

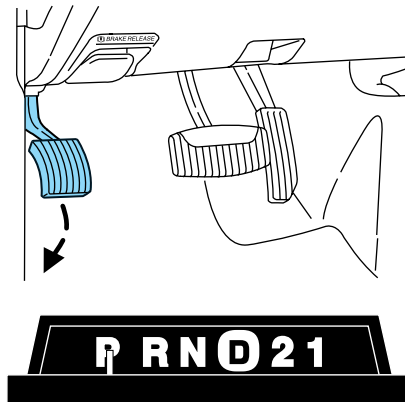

- Make sure the gearshift is in P (Park).



## Driving

- Turn the key to 4 (ON) without turning the key to 5 (START).

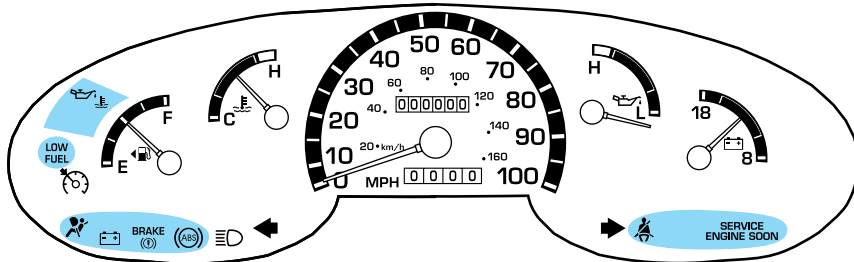
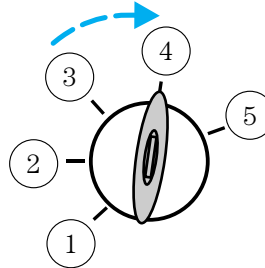

Make sure the corresponding lights illuminate or illuminate briefly. If a light fails to illuminate, have the vehicle serviced.

- If the driver's safety belt is fastened, the  light may not illuminate.

### Starting the engine

1. Turn the key to 4 (ON) without turning the key to 5 (START).
2. Turn the key to 5 (START), then release the key as soon as the engine starts. Excessive cranking could damage the starter.

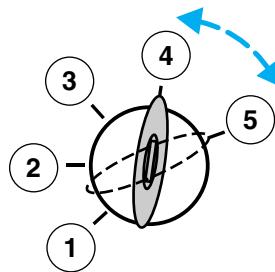

**Note:** If the engine does not start within five seconds on the first try, turn the key to 3 (OFF), wait 10 seconds and try again. If the engine still fails to start, press the accelerator to the floor and try again; this will allow the engine to crank with the fuel shut off in case the engine is flooded with fuel.

## Driving

### Using the engine block heater (if equipped)

Use of an engine block heater is strongly recommended if you live in a region where temperatures reach  $-23^{\circ}\text{C}$  ( $-10^{\circ}\text{F}$ ) or below. For best results, plug the heater in at least three hours before starting the vehicle. The heater can be plugged in the night before starting the vehicle.



To prevent electrical shock, do not use your heater with ungrounded electrical systems or two-pronged (cheater) adapters.

### Guarding against exhaust fumes

Carbon monoxide is present in exhaust fumes. Take precautions to avoid its dangerous effects.



If you smell exhaust fumes inside your vehicle, have your dealer inspect your vehicle immediately. Do not drive if you smell exhaust fumes.

### Important ventilating information

If the engine is idling while the vehicle is stopped for a long period of time, open the windows at least 2.5 cm (one inch) or adjust the heating or air conditioning to bring in fresh air.

### BRAKES

Occasional brake noise is normal. If a metal-to-metal, continuous grinding or continuous squeal sound is present, the brake linings may be worn-out and should be inspected by a qualified service technician. If the vehicle has continuous vibration or shudder in the steering wheel while braking, the vehicle should be inspected by a qualified service technician.

### Four-wheel anti-lock brake system (ABS)

Your vehicle is equipped with an Anti-lock Braking System (ABS). This system helps you maintain steering control during emergency stops by keeping the brakes from locking. Noise from the ABS pump motor and brake pedal pulsation may be observed during ABS braking; any pulsations or mechanical noise you may feel or hear is normal.

### **ABS warning lamp**

The  lamp in the instrument cluster momentarily illuminates when the ignition is turned to ON. If the light does not illuminate during start up, remains on or flashes, the ABS may be disabled and the ABS may need to be serviced.

Even when the ABS is disabled, normal braking is still effective. (If your BRAKE warning lamp illuminates with the parking brake released, have your brake system serviced immediately.)

**BRAKE**  
(!)

### Using ABS

When hard braking is required, apply continuous force on the brake pedal; do not pump the brake pedal since this will reduce the effectiveness of the ABS and will increase your vehicle's stopping distance. The ABS will be activated immediately, allowing you to retain full steering control during hard braking and on slippery surfaces. However, the ABS does not decrease stopping distance.

### Parking brake (P)

To set the parking brake (1), press the parking brake pedal down until the pedal stops. The BRAKE warning lamp will illuminate and will remain illuminated until the parking brake is released.

To release, pull the lever (2).

 Always set the parking brake fully and make sure that the gearshift is securely latched in P (Park).

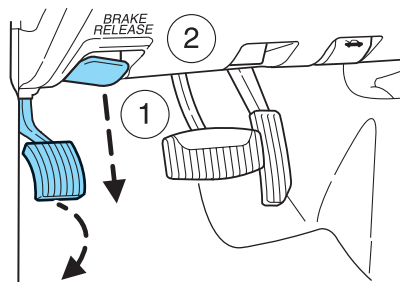

**BRAKE**  
(!)

### STEERING

To prevent damage to the power steering system:

- Never hold the steering wheel at its furthest turning points (until it stops) for more than a few seconds when the engine is running.
- Do not operate the vehicle with a low power steering pump fluid level (below the MIN mark on the reservoir).

If the power steering system breaks down (or if the engine is turned off), you can steer the vehicle manually, but it takes more effort.

## Driving

If the steering wanders or pulls, check for:

- an underinflated tire
- uneven tire wear
- loose or worn suspension components
- loose or worn steering components
- improper steering alignment

### TRACTION-LOK AXLE (IF EQUIPPED)

This axle provides added traction on slippery surfaces, particularly when one wheel is on a poor traction surface. Under normal conditions, the Traction-Lok axle functions like a standard rear axle.



To reduce the risk of injury, never run the engine with one wheel off the ground, such as when changing a tire.

### PREPARING TO DRIVE YOUR VEHICLE



Utility vehicles have a significantly higher rollover rate than other types of vehicles.



In a rollover crash, an unbelted person is significantly more likely to die than a person wearing a safety belt.

Your vehicle has larger tires and increased ground clearance, giving the vehicle a higher center of gravity than a passenger car.



Vehicles with a higher center of gravity such as utility and four-wheel drive vehicles handle differently than vehicles with a lower center of gravity. Utility and four-wheel drive vehicles are **not** designed for cornering at speeds as high as passenger cars any more than low-slung sports cars are designed to perform satisfactorily under off-road conditions. Avoid sharp turns, excessive speed and abrupt maneuvers in these vehicles. Failure to drive cautiously could result in an increased risk of loss of vehicle control, vehicle rollover, personal injury and death.

## Driving



Loaded vehicles, with a higher center of gravity, may handle differently than unloaded vehicles. Extra precautions, such as slower speeds and increased stopping distance, should be taken when driving a heavily loaded vehicle.

### VEHICLE STABILITY AND HANDLING

The risk of a rollover crash increases as the number of people and load in the vehicle increase. This increased risk occurs because the passenger weight and load raises the vehicle's center of gravity and causes it to shift rearward. As a result, the van has less resistance to rollover and handles differently from other commonly driven passenger vehicles, making it more difficult to control in an emergency situation. Placing any load on the roof also raises the center of gravity and increases the potential for rollover.

The van should be operated by an experienced driver. An organization that owns a 15-passenger van should select one or two experienced drivers to drive the van on a regular basis. These drivers will gain valuable experience handling the van. This experience will help make each trip safer.

The van should be operated at a safe speed which, in some conditions, may be less than the posted speed limit.

Further, all occupants should be properly restrained. Most people killed in rollover crashes in 15-passenger vans were unbelted. Occupants can dramatically reduce their risk of being killed or seriously injured in a rollover crash by simply using their seat belts. Organizations that own 15-passenger vans should have a written seat belt use policy. Drivers should be responsible for enforcing the policy.

### AUTOMATIC TRANSMISSION OPERATION

#### Brake-shift interlock

This vehicle is equipped with a brake-shift interlock feature that prevents the gearshift lever from being moved from P (Park) when the ignition is in the ON position unless brake pedal is depressed.

If you cannot move the gearshift lever out of P (Park) with ignition in the ON position and the brake pedal depressed:

1. Apply the parking brake, turn ignition key to LOCK, then remove the key.
2. Insert the key and turn it to OFF. **Apply the brake pedal and shift to N (Neutral).**

## Driving

 In the ignition OFF position, the automatic transmission shift lever can be moved from the P (Park) position without the brake pedal depressed. To avoid unwanted vehicle movement, always set the parking brake.

3. Start the vehicle.

If it is necessary to use the above procedure to move the gearshift lever, it is possible that a fuse has blown or the vehicle's brakelamps are not operating properly. Refer to *Fuses and relays* in the *Roadside emergencies* chapter.

 Do not drive your vehicle until you verify that the brakelamps are working.

 Always set the parking brake fully and make sure the gearshift is latched in P (Park). Turn the ignition to the LOCK position and remove the key whenever you leave your vehicle.

 If the parking brake is fully released, but the brake warning lamp remains illuminated, the brakes may not be working properly. See your dealer or a qualified service technician.

### Understanding the gearshift positions of the 4-speed automatic transmission



#### **P (Park)**

This position locks the transmission and prevents the rear wheels from turning.

To put your vehicle in gear:

- Start the engine
- Depress the brake pedal
- Move the gearshift lever into the desired gear

## Driving

To put your vehicle in P (Park):

- Come to a complete stop
- Move the gearshift lever and securely latch it in P (Park)



Always set the parking brake fully and make sure the gearshift is latched in P (Park). Turn the ignition to the LOCK position and remove the key whenever you leave your vehicle.

### **R (Reverse)**

With the gearshift lever in R (Reverse), the vehicle will move backward. Always come to a complete stop before shifting into and out of R (Reverse).

### **N (Neutral)**

With the gearshift lever in N (Neutral), the vehicle can be started and is free to roll. Hold the brake pedal down while in this position.

### **D (Overdrive)**

The normal driving position for the best fuel economy. Transmission operates in gears one through four. **D** (Overdrive) can be deactivated by pressing the transmission control switch on the end of the gearshift lever. This will illuminate the O/D OFF lamp and activate Drive.

### **Drive (not shown)**

Drive is activated when the transmission control switch is pressed.

- This position allows for all forward gears except overdrive.
- O/D OFF lamp is illuminated.
- Provides engine braking.
- Use when driving conditions cause excessive shifting from O/D to other gears. Examples: city traffic, hilly terrain, heavy loads, trailer towing and when engine braking is required.
- To return to O/D (overdrive mode), press the transmission control switch. The O/D OFF lamp will not be illuminated.
- O/D (Overdrive) is automatically returned each time the key is turned off.

## Driving

### 2 (Second)

This position allows for second gear only.

- Provides engine braking.
- Use to start-up on slippery roads.
- To return to **D** (Overdrive), move the gearshift lever into the **D** (Overdrive) position.
- Selecting 2 (Second) at higher speeds will cause the transmission to downshift to second gear at the appropriate vehicle speed.

### 1 (First)

- Provides maximum engine braking.
- Allows upshifts by moving gearshift lever.
- Will not downshift into 1 (First) at high speeds; allows for 1 (First) when vehicle reaches slower speeds.

### Forced downshifts

- Allowed in **D** (Overdrive) or Drive.
- Depress the accelerator to the floor.
- Allows transmission to select an appropriate gear.

### **Shift strategy (4R100 automatic transmission)**

To account for customer driving habits and conditions, your 4R100 automatic transmission electronically controls the shift quality by using an adaptive learning strategy. The adaptive learning strategy is maintained by power from the battery. When the battery is disconnected or a new battery is installed, the transmission must relearn its adaptive strategy. Optimal shifting will resume within a few hundred kilometers (miles) of operation.

**If the shift quality does not improve within a few hundred kilometers (miles) of operation, or if the downshifts and other throttle conditions do not function normally, see your dealer or a qualified service technician as soon as possible.**

### ***If your vehicle goes off the edge of the pavement***

- If your vehicle goes off the edge of the pavement, slow down, but avoid severe brake application, ease the vehicle back onto the pavement only after reducing your speed. Do not turn the steering wheel too sharply while returning to the road surface.
- It may be safer to stay on the apron or shoulder of the road and slow down gradually before returning to the pavement. You may lose control if you do not slow down or if you turn the steering wheel too sharply or abruptly.



## Driving

- It often may be less risky to strike small objects, such as highway reflectors, with minor damage to your vehicle rather than attempt a sudden return to the pavement which could cause the vehicle to slide sideways out of control or roll over. Remember, your safety and the safety of others should be your primary concern.



Vehicles with a higher center of gravity such as utility and four-wheel drive vehicles handle differently than vehicles with a lower center of gravity. Utility and four-wheel drive vehicles are **not** designed for cornering at speeds as high as passenger cars any more than low-slung sports cars are designed to perform satisfactorily under off-road conditions. Avoid sharp turns, excessive speed and abrupt maneuvers in these vehicles. Failure to drive cautiously could result in an increased risk of loss of vehicle control, vehicle rollover, personal injury and death.

### ***If your vehicle gets stuck in mud or snow***

If your vehicle gets stuck in mud or snow, it may be rocked out by shifting from forward and reverse gears, stopping between shifts in a steady pattern. Press lightly on the accelerator in each gear.

**Do not rock the vehicle if the engine is not at normal operating temperature or damage to the transmission may occur.**

**Do not rock the vehicle for more than a minute or damage to the transmission and tires may occur, or the engine may overheat.**

### **DRIVING THROUGH WATER**

If driving through deep or standing water is unavoidable, proceed very slowly especially if the depth is not known. Never drive through water that is higher than the bottom of the hubs (for trucks) or the bottom of the wheel rims (for cars). Traction or brake capability may be limited and your vehicle may stall. Water may also enter your engine's air intake and severely damage your engine.

Once through the water, always dry the brakes by moving your vehicle slowly while applying light pressure on the brake pedal. Wet brakes do not stop the vehicle as quickly as dry brakes. **Driving through deep water where the transmission vent tube is submerged may allow water into the transmission and cause internal transmission damage.**

## Driving

### EMERGENCY MANEUVERS

- In an unavoidable emergency situation where a sudden sharp turn must be made, remember to avoid “over-driving” your vehicle, i.e., turn the steering wheel only as rapidly and as far as required to avoid the emergency. Excessive steering will result in less vehicle control, not more. Additionally, smooth variations of the accelerator and/or brake pedal pressure should be utilized if changes in vehicle speed are called for. Avoid abrupt steering, acceleration or braking which could result in an increased risk of loss of vehicle control, vehicle rollover and/or personal injury. Use all available road surface to return the vehicle to a safe direction of travel.
- In the event of an emergency stop, avoid skidding the tires and do not attempt any sharp steering wheel movements.



Vehicles with a higher center of gravity such as utility and four-wheel drive vehicles handle differently than vehicles with a lower center of gravity. Utility and four-wheel drive vehicles are **not** designed for cornering at speeds as high as passenger cars any more than low-slung sports cars are designed to perform satisfactorily under off-road conditions. Avoid sharp turns, excessive speed and abrupt maneuvers in these vehicles. Failure to drive cautiously could result in an increased risk of loss of vehicle control, vehicle rollover, personal injury and death.

- If the vehicle goes from one type of surface to another (i.e., from concrete to gravel) there will be a change in the way the vehicle responds to a maneuver (steering, acceleration or braking). Again, avoid these abrupt inputs.

### VEHICLE LOADING

Before loading a vehicle, familiarize yourself with the following terms:

- **Base Curb Weight:** Weight of the vehicle including any standard equipment, fluids, lubricants, etc. It does not include occupants or aftermarket equipment.
- **Payload:** Combined maximum allowable weight of cargo, occupants and optional equipment. The payload equals the gross vehicle weight rating minus base curb weight.
- **GVW (Gross Vehicle Weight):** Base curb weight plus payload weight.

## Driving

- **GVWR (Gross Vehicle Weight Rating):** Maximum allowable total weight of the base vehicle, occupants, optional equipment and cargo. The GVWR is specific to each vehicle and is listed on the Safety Certification Label on the driver's door pillar.
- **GAWR (Gross Axle Weight Rating):** Carrying capacity for each axle system. The GAWR is specific to each vehicle and is listed on the Safety Certification Label on the driver's door pillar.
- **GCW (Gross Combined Weight):** The combined weight of the towing vehicle (including occupants and cargo) and the loaded trailer.
- **GCWR (Gross Combined Weight Rating):** Maximum allowable combined weight of towing vehicle (including occupants and cargo) and the loaded trailer.
- **Maximum Trailer Weight Rating:** Maximum weight of a trailer the vehicle is permitted to tow. The maximum trailer weight rating is determined by subtracting the vehicle curb weight for each engine/transmission combination, any required option weight for trailer towing and the weight of the driver from the GCWR for the towing vehicle.
- **Maximum Trailer Weight:** Maximum weight of a trailer the loaded vehicle, including occupants and cargo, is permitted to tow. It is determined by subtracting the weight of the loaded trailer towing vehicle from the GCWR for the towing vehicle.
- **Trailer Weight Range:** Specified range of trailer weight from zero to the maximum trailer weight rating.

Remember to figure in the tongue load of your loaded trailer when figuring the total weight.

The Safety Certification Label, located on the driver's door pillar, lists vehicle weight rating limitations. Before adding any additional equipment, refer to these limitations.

Always ensure that the weight of occupants, cargo and equipment is within the weight limitations, including both gross vehicle weight and front and rear gross axle weight rating limits.

**Note:** Do not exceed the GVWR or the GAWR specified on the certification label.



Exceeding any vehicle weight rating limitation could result in serious damage to the vehicle, loss of vehicle control, vehicle rollover, and/or personal injury.

## Driving

Do not use replacement tires with lower load carrying capacities than the originals because they may lower the vehicle's GVWR and GAWR limitations. Replacement tires with a higher limit than the originals do not increase the GVWR and GAWR limitations.

### Special loading instructions for owners of pickup trucks and utility-type vehicles



For important information regarding safe operation of this type of vehicle, see the **Preparing to drive your vehicle** section in this chapter.



Loaded vehicles may handle differently than unloaded vehicles. Extra precautions, such as slower speeds and increased stopping distance, should be taken when driving a heavily loaded vehicle.

Your vehicle can haul more cargo and people than most passenger cars. Depending upon the type and placement of the load, hauling cargo and people may raise the center of gravity of the vehicle.

### Calculating the load your vehicle can carry/tow

1. Use the appropriate maximum GCWR chart (in the *Trailer Towing* section in this chapter) for your type of engine and rear axle ratio.
2. Weigh your vehicle without cargo. To obtain correct weights, take your vehicle to a shipping company or an inspection station for trucks.
3. Subtract your loaded weight from the maximum GCWR in the chart. This is the maximum trailer weight your vehicle can tow. It must be below the maximum trailer weight shown in the chart.

### TRAILER TOWING

Refer to *7.3 Liter Power Stroke Direct Injection Turbo Diesel Owner's Guide Supplement* for diesel engine towing information.

Your vehicle may tow a class I, II or III trailer provided the maximum trailer weight is less than or equal to the maximum trailer weight listed for your engine and rear axle ratio on the following charts.

## Driving

<b>GCWR (Gross Combined Weight Rating)/Trailer Weights</b>				
<b>Engine</b>	<b>Rear axle ratio</b>	<b>Maximum GCWR - kg (lbs.)</b>	<b>Maximum Loaded Trailer Weight - kg (lbs.)</b>	<b>Maximum frontal area of trailer - m<sup>2</sup> (ft<sup>2</sup>)</b>
<b>E-150 Regular Van (6700 GVWR)</b>				
4.2L	3.55	4536 (10000)	2268 (5000)	5.52 (60)
4.6L	3.55	5216 (11500)	2903 (6400)	5.52 (60)
5.4L	3.55	5443 (12000)	3084 (6800)	5.52 (60)
<b>E-150 Regular Van (Crew) (6700 GVWR)</b>				
4.2L	3.55	4536 (10000)	2178 (4800)	5.52 (60)
4.6L	3.55	5216 (11500)	2812 (6200)	5.52 (60)
5.4L	3.55	5443 (12000)	2994 (6600)	5.52 (60)
<b>E-150 Regular Van (Conversion) (7000 GVWR)</b>				
4.2L	3.55	4536 (10000)	2178 (4800)	5.52 (60)
4.6L	3.55	5216 (11500)	2858 (6300)	5.52 (60)
5.4L	3.55	5443 (12000)	3039 (6700)	5.52 (60)
<b>E-150 Regular Van (7- and 8-passenger) (7000 GVWR)</b>				
4.2L	3.55	4536 (10000)	2132 (4700)	5.52 (60)
4.6L	3.55	5216 (11500)	2767 (6100)	5.52 (60)
5.4L	3.55	5443 (12000)	2948 (6500)	5.52 (60)

## Driving

<b>GCWR (Gross Combined Weight Rating)/Trailer Weights</b>				
<b>Engine</b>	<b>Rear axle ratio</b>	<b>Maximum GCWR - kg (lbs.)</b>	<b>Maximum Loaded Trailer Weight - kg (lbs.)</b>	<b>Maximum frontal area of trailer - m<sup>2</sup> (ft<sup>2</sup>)</b>
<b>E-250 Regular Van (7200 GVWR)</b>				
4.2L	3.73	4763 (10500)	2313 (5100)	5.52 (60)
<b>E-250 Regular Van (Conversion) (7900 GVWR)</b>				
5.4L	3.73	5897 (13000)	3402 (7500)	5.52 (60)
<b>E-250 Regular Van (8600 GVWR)</b>				
4.2L	4.10	4990 (11000)	2540 (5600)	5.52 (60)
5.4L	3.73	5897 (13000)	3402 (7500)	5.52 (60)
<b>E-250 Regular Van (Crew) (8600 GVWR)</b>				
4.2L	4.10	4990 (11000)	2449 (5400)	5.52 (60)
5.4L	3.73	5897 (13000)	3311 (7300)	5.52 (60)
<b>E-250 Extended Van (7300 GVWR)</b>				
4.2L	3.73	4763 (10500)	2268 (5000)	5.52 (60)
<b>E-250 Extended Van (Conversion) (7500 GVWR)</b>				
5.4L	3.73	5897 (13000)	3266 (7200)	5.52 (60)
<b>E-250 Extended Van (8600 GVWR)</b>				
4.2L	4.10	4990 (11000)	2449 (5400)	5.52 (60)
5.4L	3.73	5897 (13000)	3311 (7300)	5.52 (60)

## Driving

<b>GCWR (Gross Combined Weight Rating)/Trailer Weights</b>				
<b>Engine</b>	<b>Rear axle ratio</b>	<b>Maximum GCWR - kg (lbs.)</b>	<b>Maximum Loaded Trailer Weight - kg (lbs.)</b>	<b>Maximum frontal area of trailer - m<sup>2</sup> (ft<sup>2</sup>)</b>
<b>E-250 Extended Van (Crew) (8600 GVWR)</b>				
4.2L	4.10	4990 (11000)	2449 (5400)	5.52 (60)
5.4L	3.73	5897 (13000)	3311 (7300)	5.52 (60)
<b>E-350 Regular Van (9500 GVWR)</b>				
5.4L	3.55	5443 (12000)	2858 (6300)	5.52 (60)
5.4L	4.10	5897 (13000)	3311 (7300)	5.52 (60)
6.8L	3.73	6804 (15000)	4173 (9200)	5.52 (60)
6.8L	4.10	8391 (18500)	4536 (10000)	5.52 (60)
<b>E-350 Regular Van (Crew) (9500 GVWR)</b>				
5.4L	3.55	5443 (12000)	2767 (6100)	5.52 (60)
5.4L	4.10	5897 (13000)	3221 (7100)	5.52 (60)
6.8L	3.73	6804 (15000)	4082 (9000)	5.52 (60)
6.8L	4.10	8391 (18500)	4536 (10000)	5.52 (60)
<b>E-350 Extended Van (9400 GVWR)</b>				
5.4L	3.55	5443 (12000)	2812 (6200)	5.52 (60)
5.4L	4.10	5897 (13000)	3266 (7200)	5.52 (60)

## Driving

<b>GCWR (Gross Combined Weight Rating)/Trailer Weights</b>				
<b>Engine</b>	<b>Rear axle ratio</b>	<b>Maximum GCWR - kg (lbs.)</b>	<b>Maximum Loaded Trailer Weight - kg (lbs.)</b>	<b>Maximum frontal area of trailer - m<sup>2</sup> (ft<sup>2</sup>)</b>
6.8L	3.73	6804 (15000)	4082 (9000)	5.52 (60)
6.8L	4.10	8391 (18500)	4536 (10000)	5.52 (60)
<b>E-350 Extended Van (Crew) (9250 GVWR)</b>				
5.4L	3.55	5443 (12000)	2676 (5900)	5.52 (60)
5.4L	4.10	5897 (13000)	3130 (6900)	5.52 (60)
6.8L	3.73	6804 (15000)	3992 (8800)	5.52 (60)
6.8L	4.10	8391 (18500)	4536 (10000)	5.52 (60)
<b>E-350 Regular Wagon (8 passenger) (8600 GVWR)</b>				
5.4L	3.73/4.10	5897 (13000)	3175 (7000)	5.52 (60)
6.8L	3.73	6804 (15000)	3992 (8800)	5.52 (60)
6.8L	4.10	8391 (18500)	4536 (10000)	5.52 (60)
<b>E-350 Regular Wagon (12 passenger) (8600 GVWR)</b>				
5.4L	3.73/4.10	5897 (13000)	3130 (6900)	5.52 (60)
<b>E-350 Regular Wagon (12 passenger) (8600 GVWR)</b>				
6.8L	3.73	6804 (15000)	3992 (8800)	5.52 (60)
6.8L	4.10	8391 (18500)	4536 (10000)	5.52 (60)



## Driving

<b>GCWR (Gross Combined Weight Rating)/Trailer Weights</b>				
<b>Engine</b>	<b>Rear axle ratio</b>	<b>Maximum GCWR - kg (lbs.)</b>	<b>Maximum Loaded Trailer Weight - kg (lbs.)</b>	<b>Maximum frontal area of trailer - m<sup>2</sup> (ft<sup>2</sup>)</b>
<b>E-350 Extended Wagon (12 passenger) (9300 GVWR)</b>				
5.4L	3.55	5443 (12000)	2585 (5700)	5.52 (60)
5.4L	4.10	5897 (13000)	3039 (6700)	5.52 (60)
6.8L	3.73	6804 (15000)	3901 (8600)	5.52 (60)
6.8L	4.10	8391 (18500)	4536 (10000)	5.52 (60)
<b>E-350 Extended Wagon (15 passenger) (9100 GVWR)</b>				
5.4L	3.55	5443 (12000)	2540 (5600)	5.52 (60)
5.4L	4.10	5897 (13000)	2994 (6600)	5.52 (60)
<b>E-350 Extended Wagon (15 passenger) (9300 GVWR)</b>				
6.8L	3.73	6804 (15000)	3856 (8500)	5.52 (60)
6.8L	4.10	8391 (18500)	4536 (10000)	5.52 (60)
<b>E-350 Cutaway (138" wheelbase, single rear wheel) (9600 GVWR)</b>				
5.4L	4.10	5897 (13000)	3629 (8000)	5.52 (60)
6.8L	4.10	8391 (18500)	4536 (10000)	5.52 (60)

## Driving

<b>GCWR (Gross Combined Weight Rating)/Trailer Weights</b>				
<b>Engine</b>	<b>Rear axle ratio</b>	<b>Maximum GCWR - kg (lbs.)</b>	<b>Maximum Loaded Trailer Weight - kg (lbs.)</b>	<b>Maximum frontal area of trailer - m<sup>2</sup> (ft<sup>2</sup>)</b>
<b>E-350 Cutaway (138" wheelbase, dual rear wheel) (10700 GVWR)</b>				
5.4L	4.10	5897 (13000)	3583 (7900)	5.52 (60)
6.8L	4.10	8391 (18500)	4536 (10000)	5.52 (60)
<b>E-350 Cutaway (158" wheelbase, dual rear wheel) (11500 GVWR)</b>				
5.4L	4.10	5897 (13000)	3538 (7800)	5.52 (60)
6.8L	4.10	8391 (18500)	4536 (10000)	5.52 (60)
<b>E-350 Cutaway (176" wheelbase, dual rear wheel) (11500 GVWR)</b>				
5.4L	4.10/4.56	5897 (13000)	3538 (7800)	5.52 (60)
6.8L	4.10/4.56	8391 (18500)	4536 (10000)	5.52 (60)
<b>E-350 Cutaway (138" wheelbase, dual rear wheel) (10000 GVWR)</b>				
5.4L	4.10	5897 (13000)	3583 (7900)	5.52 (60)
6.8L	4.10	8391 (18500)	4536 (10000)	5.52 (60)
<b>E-350 Chassis Cab (138" wheelbase, dual rear wheel) (10700 GVWR)</b>				
5.4L	4.10	5897 (13000)	3583 (7900)	5.52 (60)
6.8L	4.10	8391 (18500)	4536 (10000)	5.52 (60)

## Driving

<b>GCWR (Gross Combined Weight Rating)/Trailer Weights</b>				
<b>Engine</b>	<b>Rear axle ratio</b>	<b>Maximum GCWR - kg (lbs.)</b>	<b>Maximum Loaded Trailer Weight - kg (lbs.)</b>	<b>Maximum frontal area of trailer - m<sup>2</sup> (ft<sup>2</sup>)</b>
<b>E-350 Chassis Cab (158" wheelbase, dual rear wheel) (11500 GVWR)</b>				
5.4L	4.10	5897 (13000)	3538 (7800)	5.52 (60)
6.8L	4.10	8391 (18500)	4536 (10000)	5.52 (60)
<b>E-350 Chassis Cab (176" wheelbase, dual rear wheel) (11500 GVWR)</b>				
5.4L	4.10/4.56	5897 (13000)	3538 (7800)	5.52 (60)
6.8L	4.10/4.56	8391 (18500)	4536 (10000)	5.52 (60)
<b>E-250 Stripped Chassis (Single rear wheel) (8600 GVWR)</b>				
4.2L	4.09	4990 (11000)	3311 (7300)	5.52 (60)
<b>E-350 Stripped Chassis (138" wheelbase) (9600 GVWR)</b>				
5.4L	3.55/4.10	5897 (13000)	3992 (8800)	5.52 (60)
6.8L	4.10	8391 (18500)	4536 (10000)	5.52 (60)
<b>E-350 Stripped Chassis (158" wheelbase) (9600 GVWR)</b>				
5.4L	3.55/4.10	5897 (13000)	3946 (8700)	5.52 (60)
6.8L	4.10	8391 (18500)	4536 (10000)	5.52 (60)

## Driving

<b>GCWR (Gross Combined Weight Rating)/Trailer Weights</b>				
<b>Engine</b>	<b>Rear axle ratio</b>	<b>Maximum GCWR - kg (lbs.)</b>	<b>Maximum Loaded Trailer Weight - kg (lbs.)</b>	<b>Maximum frontal area of trailer - m<sup>2</sup> (ft<sup>2</sup>)</b>
<b>E-350 Stripped Chassis (138" wheelbase) (10000 GVWR)</b>				
5.4L	4.10	5897 (13000)	3856 (8500)	5.52 (60)
6.8L	4.10	8391 (18500)	4536 (10000)	5.52 (60)
<b>E-350 Stripped Chassis (158" wheelbase) (10000 GVWR)</b>				
5.4L	4.10	5897 (13000)	3856 (8500)	5.52 (60)
6.8L	4.10	8391 (18500)	4536 (10000)	5.52 (60)
<b>E-350 Chassis Cab (158" wheelbase) (11000 GVWR)</b>				
5.4L	4.10	5897 (13000)	3856 (8500)	5.52 (60)
6.8L	4.10	8391 (18500)	4536 (10000)	5.52 (60)
<b>E-350 Stripped Chassis (176" wheelbase) (10000 GVWR)</b>				
5.4L	4.10	5897 (13000)	3810 (8400)	5.52 (60)
6.8L	4.10	8391 (18500)	4536 (10000)	5.52 (60)
<b>E-450 Cutaway and Chassis Cab (all wheelbases, all GVWRs)</b>				
6.8L	4.10/4.56	9072 (20000)	4536 (10000)	5.52 (60)
<b>E-450 Stripped Chassis (all wheelbases, all GVWRs)</b>				
5.4L	4.56	5897 (13000)	3719 (8200)	5.52 (60)
6.8L	4.56	8391 (18500)	4536 (10000)	5.52 (60)

## Driving

GCWR (Gross Combined Weight Rating)/Trailer Weights				
Engine	Rear axle ratio	Maximum GCWR - kg (lbs.)	Maximum Loaded Trailer Weight - kg (lbs.)	Maximum frontal area of trailer - m <sup>2</sup> (ft <sup>2</sup> )
<b>E-550 (all wheelbases, all GVWRs)</b>				
6.8L	4.88	9072 (20000)	4536 (10000)	5.52 (60)
<p>* Maximum trailer weight for all cutaway (E-350 and E-450) vehicles must be calculated by subtracting the weight of the vehicle (including incomplete vehicle weight, and payload which includes second unit body weight, cargo, and passengers) from the GCW. Otherwise, maximum trailer weight is 4536 kg (10000 lbs)</p>				
<p>For high altitude operation reduce GCWR by 2% per 300 meters (1000 ft) elevation. To determine the maximum trailer weight designed for your particular vehicle as equipped, follow the section <i>Calculating the load your vehicle can tow/carry</i> earlier in this chapter.</p>				

Your vehicle's load capacity is designated by weight, not by volume, so you cannot necessarily use all available space when loading a vehicle.

Distribute the load so that only 10 to 15% of the total is on the tongue. Tie down the load so that it does not shift and change the weight on the hitch.

Towing a trailer places an additional load on your vehicle's engine, transmission, axle, brakes, tires and suspension. Inspect these components carefully after any towing operation.

**Note:** Do not exceed the GVWR or the GAWR specified on the certification label.



Towing trailers beyond the maximum recommended gross trailer weight exceeds the limit of the vehicle and could result in engine damage, transmission damage, structural damage, loss of vehicle control, vehicle rollover and personal injury.

## Driving

### Preparing to tow

Use the proper equipment for towing a trailer and make sure it is properly attached to your vehicle. See your dealer or a reliable trailer dealer if you require assistance.

### Hitches

Do not use or install hitches that clamp onto the bumper or to the axle. Underbody hitches are acceptable if installed properly.

### Safety chains

Always connect the trailer's safety chains to the frame or hook retainers of the vehicle hitch. To connect the trailer's safety chains, cross the chains under the trailer tongue and allow slack for turning corners.

If you use a rental trailer, follow the instructions that the rental agency gives to you.

**Do not attach safety chains to the bumper.**

### Trailer brakes

Electric brakes and manual, automatic or surge-type trailer brakes are safe if installed properly and adjusted to the manufacturer's specifications. The trailer brakes must meet local and Federal regulations.



Do not connect a trailer's hydraulic brake system directly to your vehicle's brake system. Your vehicle may not have enough braking power and your chances of having a collision greatly increase.

The braking system of the tow vehicle is rated for operation at the GVWR not GCWR.

### Trailer lamps

Trailer lamps are required on most towed vehicles. Make sure your trailer lamps conform to local and Federal regulations. See your dealer or trailer rental agency for proper instructions and equipment for hooking up trailer lamps.

### Using a step bumper (if equipped)

The rear bumper is equipped with an integral hitch and only requires a ball with a 25.4 mm (one inch) shank diameter. The bumper has a 2,270 kg (5,000 lb.) trailer weight and 227 kg (500 lb.) tongue weight capacity.

If it is necessary to relocate the trailer hitch ball position, a frame-mounted trailer hitch must be installed.

### Driving while you tow

When towing a trailer:

- Turn off the speed control. The speed control may shut off automatically when you are towing on long, steep grades.
- Consult your local motor vehicle speed regulations for towing a trailer.
- To eliminate excessive shifting, use a lower gear. This will also assist in transmission cooling.
- Anticipate stops and brake gradually.

When descending long, steep downhill grades, always use a lower gear to provide engine braking to save wear on brakes. Use Drive (Overdrive OFF) on moderately steep hills, Second (2) on steep hills, and First (1) on very steep hills. **Do not apply your brakes continuously, as they may overheat and become less effective.**

### Servicing after towing

If you tow a trailer for long distances, your vehicle will require more frequent service intervals. Refer to your scheduled maintenance guide for more information.

### Trailer towing tips

- Practice turning, stopping and backing up before starting on a trip to get the feel of the vehicle trailer combination. When turning, make wider turns so the trailer wheels will clear curbs and other obstacles.
- Allow more distance for stopping with a trailer attached.
- The trailer tongue weight should be 10–15% of the loaded trailer weight.
- If you will be towing a trailer frequently in hot weather, hilly conditions, at GCW, or any combination of these factors, consider refilling your rear axle with synthetic gear lube. Refer to the *Maintenance and specifications* chapter for the lubricant specification.
- After you have traveled 80 km (50 miles), thoroughly check your hitch, electrical connections and trailer wheel lug nuts.
- When stopped in traffic for long periods of time in hot weather, place the gearshift in P (Park) and increase idle speed. This aids engine cooling and air conditioner efficiency.

## Driving

- Vehicles with trailers should not be parked on a grade. If you must park on a grade, place wheel chocks under the trailer's wheels.

### Launching or retrieving a boat

**Disconnect the wiring to the trailer before backing the trailer into the water. Reconnect the wiring to the trailer after the trailer is removed from the water.**

When backing down a ramp during boat launching or retrieval:

- do not allow the static water level to rise above the bottom edge of the rear bumper.
- do not allow waves to break higher than 15 cm (6 inches) above the bottom edge of the rear bumper.

Exceeding these limits may allow water to enter vehicle components:

- causing internal damage to the components.
- affecting driveability, emissions and reliability.

Replace the rear axle lubricant any time the axle has been submerged in water. Rear axle lubricant quantities are not to be checked or changed unless a leak is suspected or repair required.

### RECREATIONAL TOWING (ALL WHEELS ON THE GROUND)

An example of recreational towing would be towing your vehicle on a trip behind a motorhome. Follow these guidelines if you have the need for recreational towing your vehicle with all four wheels on the ground. These guidelines are designed to ensure that your transmission is not damaged.

#### **2WD vehicles (with automatic transmissions):**

- Place the transmission in N (Neutral)
- Maximum speed is 56 km (35 mph)
- Maximum distance is 80 km (50 miles)

If a distance of 80 km (50 miles) or a speed of 56 km (35 mph) must be exceeded, the drive shaft will have to be removed.

Ford recommends the driveshaft be removed/installed only by a qualified technician. See your local dealer for driveshaft removal/installation.

**Improper removal/installation of the driveshaft can cause transmission fluid loss, damage to the driveshaft and internal transmission components.**



## Roadside Emergencies

### GETTING ROADSIDE ASSISTANCE

To fully assist you should you have a vehicle concern, Ford Motor Company offers a complimentary roadside assistance program. This program is separate from the New Vehicle Limited Warranty. The service is available:

- 24-hours, seven days a week
- for the New Vehicle Limited Warranty period of three years or 60,000 km (36,000 miles), whichever occurs first on Ford and Mercury vehicles, and four years or 80,000 km (50,000 miles) on Lincoln vehicles.

Roadside assistance will cover:

- changing a flat tire
- jump-starts
- lock-out assistance
- limited fuel delivery
- towing of your disabled vehicle to the nearest Ford Motor Company dealership, or your selling dealer if within 56.3 km (35 miles) of the nearest Ford Motor Company dealership (one tow per disablement). Even non-warranty related tows, like accidents or getting stuck in the mud or snow, are covered (some exclusions apply, such as impound towing or repossession).

### Canadian customers refer to your Owner Information Guide for information on:

- coverage period
- exact fuel amounts
- towing of your disabled vehicle
- emergency travel expense reimbursement
- travel planning benefits

### USING ROADSIDE ASSISTANCE

Complete the roadside assistance identification card and place it in your wallet for quick reference. In the United States, this card is found in the Owner Guide portfolio in the glove compartment in Ford vehicles and is mailed to you if you own a Mercury or Lincoln. In Canada, the card is found in the Owner Information Guide in the glove compartment.

U.S. Ford or Mercury vehicle customers who require roadside assistance, call 1-800-241-3673; Lincoln vehicle customers call 1-800-521-4140.

## Roadside Emergencies

Canadian customers who require roadside assistance, call 1-800-665-2006.

If you need to arrange roadside assistance for yourself, Ford Motor Company will reimburse a reasonable amount. To obtain reimbursement information, U.S. Ford or Mercury vehicles customers call 1-800-241-3673; Lincoln vehicle customers call 1-800-521-4140.

Canadian customers who need to obtain reimbursement information, call 1-800-665-2006.

### ROADSIDE COVERAGE BEYOND BASIC WARRANTY

In the United States, you may purchase additional roadside assistance coverage beyond this period through the Ford Auto Club by contacting your Ford or Lincoln Mercury dealer.

Similarly in Canada, for uninterrupted Roadside Assistance coverage, you may purchase extended coverage prior to your Basic Warranty's Roadside Assistance expiring. For more information and enrollment, contact 1-877-294-2582 or visit our website at [www.ford.ca](http://www.ford.ca).

### HAZARD FLASHER

The hazard flasher is located on the steering column, just behind the steering wheel. The hazard flashers will operate when the ignition is in any position.

Push in the flasher control and all front and rear direction signals will flash. Press the flasher control again to turn them off. Use it when your vehicle is disabled and is creating a safety hazard for other motorists.

**Note:** With extended use, the flasher may run down your battery.

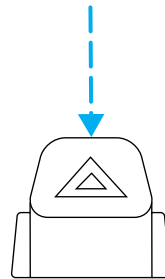

## Roadside Emergencies

### FUEL PUMP SHUT-OFF SWITCH FUEL RESET

This device stops the electric fuel pump from sending fuel to the engine when your vehicle has had a substantial jolt.

After an accident, if the engine cranks but does not start, this switch may have been activated.

Except for commercial stripped chassis vehicles, this switch is located in the passenger's footwell, by the kick panel.

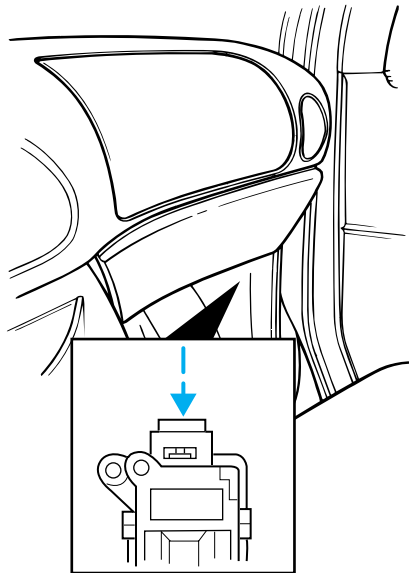

## Roadside Emergencies

On commercial stripped chassis vehicles, this switch is located on a bracket above the brake pedal.

To reset the switch:

1. Turn the ignition OFF.
2. Check the fuel system for leaks.
3. If no leaks are apparent, reset the switch by pushing in on the reset button.
4. Turn the ignition ON.
5. Wait a few seconds and return the key to OFF.
6. Make another check of leaks.

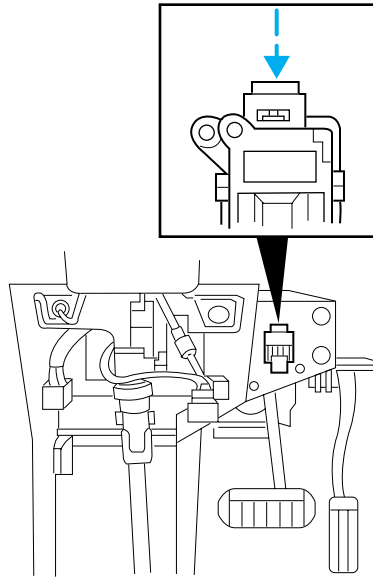

## FUSES AND RELAYS

### Fuses

If electrical components in the vehicle are not working, a fuse may have blown. Blown fuses are identified by a broken wire within the fuse. Check the appropriate fuses before replacing any electrical components.

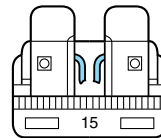

**Note:** Always replace a fuse with one that has the specified amperage rating. Using a fuse with a higher amperage rating can cause severe wire damage and could start a fire.

## Roadside Emergencies

### *Standard fuse amperage rating and color*

COLOR					
Fuse rating	Mini fuses	Standard fuses	Maxi fuses	Cartridge maxi fuses	Fuse link cartridge
2A	Grey	Grey	—	—	—
3A	Violet	Violet	—	—	—
4A	Pink	Pink	—	—	—
5A	Tan	Tan	—	—	—
7.5A	Brown	Brown	—	—	—
10A	Red	Red	—	—	—
15A	Blue	Blue	—	—	—
20A	Yellow	Yellow	Yellow	Blue	Blue
25A	Natural	Natural	—	—	—
30A	Green	Green	Green	Pink	Pink
40A	—	—	Orange	Green	Green
50A	—	—	Red	Red	Red
60A	—	—	Blue	—	Yellow
70A	—	—	Tan	—	Brown
80A	—	—	Natural	—	Black

### **Passenger compartment fuse panel**

The fuse panel is located below and to the left of the steering wheel by the brake pedal. Remove the panel cover to access the fuses.

To remove a fuse use the fuse puller tool provided on the fuse panel cover.

## Roadside Emergencies

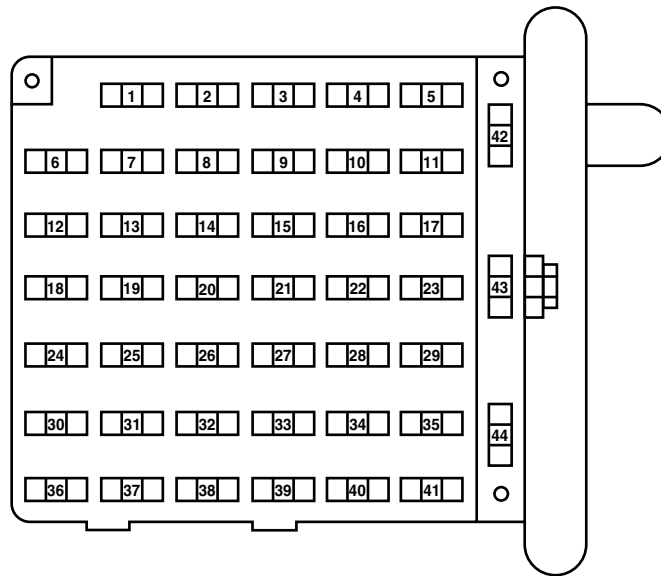

The fuses are coded as follows.

Fuse/Relay Location	Fuse Amp Rating	Passenger Compartment Fuse Panel Description
1	20A	4WABS module
2	15A	Brake warning lamp, Instrument cluster, Warning chime, 4WABS relay, Warning indicators, Low vacuum warning switch (Diesel only)
3	15A	Main light switch, RKE module, Radio, Instrument illumination, VCP and video screens, Overhead console
4	15A	Power locks w/RKE, Illuminated entry, Warning chime, Modified vehicle, Main light switch, Courtesy lamps
5	20A	RKE module, Power lock switches, Memory lock, Power locks with RKE

## Roadside Emergencies

Fuse/Relay Location	Fuse Amp Rating	Passenger Compartment Fuse Panel Description
6	10A	Brake shift interlock, Speed control, DRL module
7	10A	Multi-function switch, Turn signals
8	30A	Radio capacitor(s), Ignition coil, PCM diode, PCM power relay, Fuel heater (Diesel only), Glow plug relay (Diesel only)
9	30A	Wiper control module, Windshield wiper motor
10	20A	Main light switch, Park lamps, License lamp (external lamps), Multi-function switch (flash-to-pass)
11	15A	Brake pressure switch, Multi-function switch (hazards), Brake lamp switch, Brake lamps
12	15A	Transmission Range (TR) sensor, Backup lamps, Auxiliary battery relay
13	15A	Blend door actuator, A/C heater, Function selector switch
14	5A	Instrument cluster (air bag and charge indicator)
15	5A	Trailer battery charge relay
16	30A	Power seats
17	—	Not used
18	—	Not used
19	10A	Air bag diagnostic monitor
20	5A	Overdrive cancel switch
21	30A	Power windows*
22	15A	Memory power radio, Rear seat control unit, Video screen
23	20A	Cigar lighter, Data Link Connector (DLC)
24	—	Not used
25	10A	Left headlamp (low beam)

## Roadside Emergencies

Fuse/Relay Location	Fuse Amp Rating	Passenger Compartment Fuse Panel Description
26	—	Not used
27	5A	Radio
28	20A	Power plug
29	—	Not used
30	15A	Headlamps (high beam indicator), DRL10A
31	10A	Right Headlamp (Low Beam), DRL
32	5A	Power mirrors
33	20A	Power point #2
34	10A	Transmission Range (TR) sensor
35	30A	RKE module
36	5A	(Cluster, A/C, Illumination, Radio), Steering column assembly
37	20A	Rear power point
38	10A	Air bag diagnostic monitor
39	20A	Power point #1
40	30A	Modified vehicle
41	30A	Modified vehicle
42	—	Not used
43	20A C.B.	Power windows*
44	—	Not used

\* Either Fuse 21 or Circuit breaker 43 will be present for power windows.

### Power distribution box

The power distribution box is located in the engine compartment. The power distribution box contains high-current fuses that protect your vehicle's main electrical systems from overloads.



Always disconnect the battery before servicing high current fuses.

**Always replace the cover to the power distribution box before reconnecting the battery or refilling fluid reservoirs**



## Roadside Emergencies

If the battery has been disconnected and reconnected, refer to the *Battery* section of the *Maintenance and specifications* chapter.

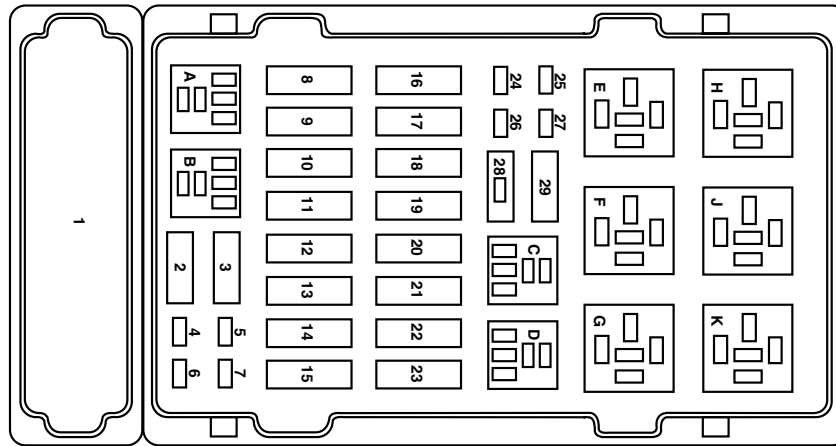

The high-current fuses are coded as follows.

Fuse/Relay Location	Fuse Amp Rating	Power Distribution Box Description
1	—	Not used
2	—	Not used
3	—	Not used
4	10A*	Powertrain Control Module (PCM) Keep Alive Memory, Instrument cluster, Voltmeter
5	10A*	Right trailer turn signal
6	10A*	Left trailer turn signal
7	20A*	Clearance lamps
8	60A**	I/P fuses 4, 5, 10, 11, 16, 22, 23, 28, 32, 38
9	30A**	PCM power relay, Engine compartment fuse 4
10	60A**	Auxiliary battery relay, Engine compartment fuses 14, 22

## Roadside Emergencies

Fuse/Relay Location	Fuse Amp Rating	Power Distribution Box Description
11	30A**	IDM relay (Diesel only)
12	60A**	Engine compartment fuses 25, 27
13	50A**	Blower motor relay (blower motor)
14	30A**	Trailer running lamps relay, Trailer backup lamps relay
15	40A**	Main light switch, Daytime Running Lights (DRL)
16	50A**	Auxiliary blower motor relay
17	30A**	Fuel pump relay
18	60A**	I/P fuses 33, 37, 39, 40, 41
19	60A**	4WABS module
20	20A**	Electric brake controller
21	50A**	Modified vehicle power
22	40A**	Trailer battery charge relay, Modified vehicles
23	60A**	Ignition switch, Fuse panel
24	30A*	Natural gas tank valves (NGV only)
25	20A*	NGV module (NGV only)
26	10A*	A/C clutch (4.2L only)
27	15A*	DRL module, Horn relay
28	—	PCM diode
29	—	Not used
A	—	Marker lamps relay
B	—	Stop lamp relay
C	—	Trailer backup lamps relay
D	—	Trailer running lamps relay
E	—	Trailer battery charge relay
F	—	IDM relay (Diesel only), A/C clutch relay (4.2L only)
G	—	PCM relay
H	—	Blower motor relay

## Roadside Emergencies

Fuse/Relay Location	Fuse Amp Rating	Power Distribution Box Description
J	—	Horn relay
K	—	Fuel pump relay
* Mini fuses ** Maxi fuses		

### Relays

Relays are located in the power distribution box and should be replaced by qualified technicians.

### CHANGING A FLAT TIRE

If you get a flat tire while driving:

- do not brake heavily.
- gradually decrease the vehicle's speed.
- hold the steering wheel firmly.
- slowly move to a safe place on the side of the road.



The use of tire sealants is not recommended and may compromise the integrity of your tires. The use of tire sealants may also affect your tire pressure monitoring system (if equipped).

### Spare tire information

The spare tire for your vehicle is stowed under the rear of your vehicle (except cutaway and stripped chassis models).

#### To remove the spare tire:

1. Open the rear doors and remove the thumb screw and anti-theft bracket. If finger pressure will not remove the thumb screw, use the lug wrench to loosen the screw.
2. Remove the access cover from the rubber strip behind the left door.

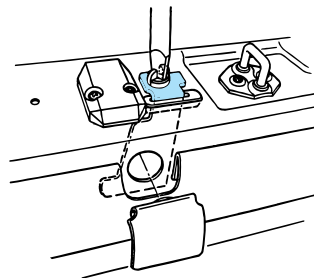

## Roadside Emergencies

3. Remove the jack handle from the right side compartment and insert the tip of the jack handle through the access hole and into the tube.

4. Turn the jack handle counterclockwise until the cable is slack and the tire can be slid from under the vehicle.

5. Remove the retainer from the spare tire.

To stow the cable retainer with the spare removed, turn the jack handle clockwise until all slack is removed.

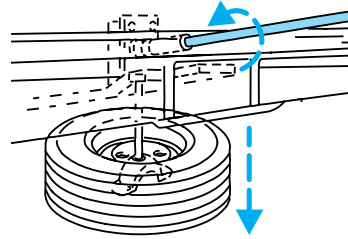

### Tire change procedure

#### *Preparing to change the tire*



To prevent the vehicle from moving when you change a tire, be sure the parking brake is set, then block (in both directions) the wheel that is diagonally opposite (other side and end of the vehicle) to the tire being changed.

1. Park on a level surface.
2. Activate the warning flashers.
3. Place the gearshift in P (Park).
4. Apply the parking brake and turn the engine off.

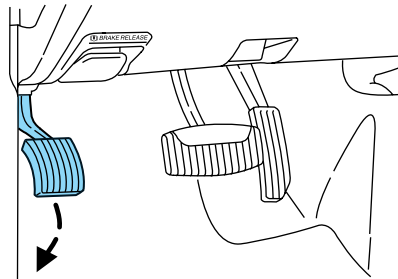

## Roadside Emergencies

5. Block the wheel that is diagonally opposite the tire you are changing.

On E-450 vehicles, the parking brake is on the transmission.

Therefore, the vehicle will not be prevented from moving when a rear wheel is lifted, even if the parking brake is applied. Be sure to block both directions of the wheel that is diagonally opposite to the wheel that is being lifted.

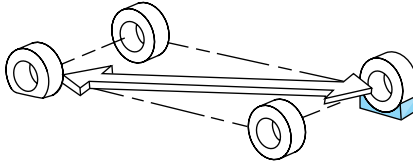

If the vehicle slips off the jack, you or someone else could be seriously injured.

6. Remove the spare tire and jack from the storage location.

- **non-chassis cab vehicles:** jack is located in the rear right-hand side of the cargo area.

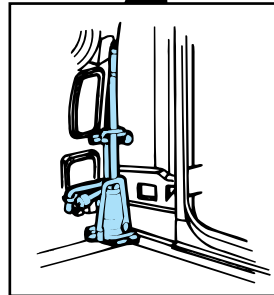
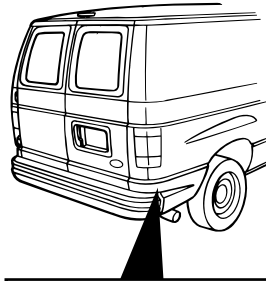

## Roadside Emergencies

- **chassis cab vehicles:** jack is strapped to a bracket behind the driver's seat.

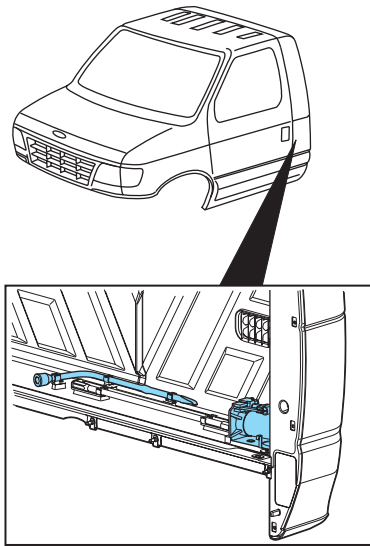

7. Use the tapered end of the lug nut wrench to unscrew wheel ornaments attached by retaining screws. Remove any wheel trim. Insert the tapered end of the lug nut wrench behind wheel covers or hubcaps and twist off.

8. Loosen the wheel nut by pulling up on the handle of the lug nut wrench about one-half turn (counterclockwise). Do not remove the wheel lug nuts until you raise the tire off the ground.

### ***Replacing the tire***

1. Assemble the jack handle sections together and lock into the jack. Use the jack handle to slide the jack under the vehicle.



To lessen the risk of personal injury, do not put any part of your body under the vehicle while changing a tire. Do not start the engine when your vehicle is on the jack. The jack is only meant for changing the tire.

2. Position the jack to raise the front or rear wheel.

## Roadside Emergencies

- Never use the front or rear differential as a jacking point.

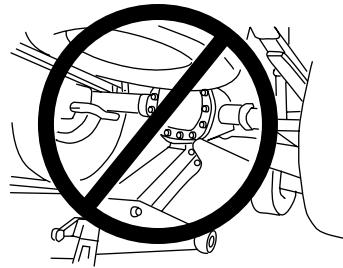

**Rear axle jacking points - All models except E-450 and E-550:**

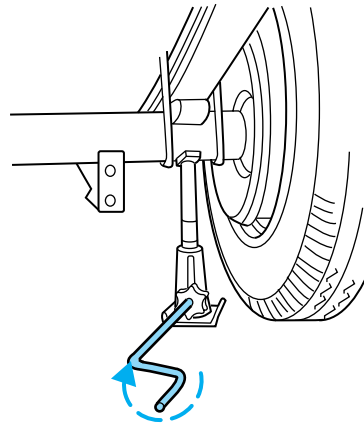

**Rear axle jacking points - E-450 and E-550:**

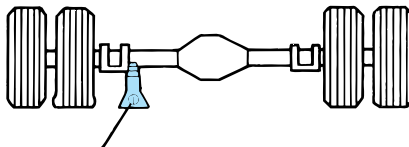

## Roadside Emergencies

### Front axle jacking points - All models except E-550:

- All models except E-550

Place the jack under the **pin** on the front surface of the front axle.

### Do not place the jack under or on the steering linkage.

- Turn the jack handle clockwise until the wheel is completely off the ground.
- Remove the lug nuts with the lug nut wrench.
- Replace the flat tire with the spare tire.

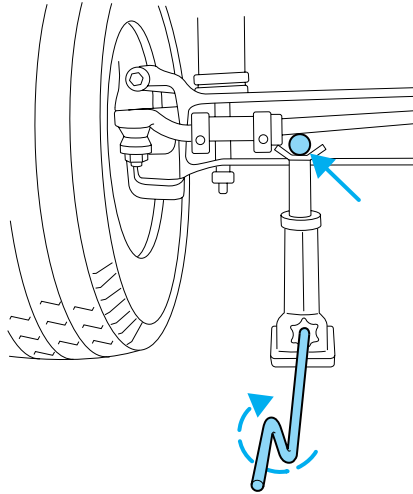

### Front axle jacking points - E-550:

Place the jack under the front axle directly below the springs.

### Do not place the jack under or on the steering linkage.

- Slide the notched end of the jack handle over the release valve and use the handle to slide the jack under the vehicle. Make sure the valve is closed by turning it clockwise.
- Insert the jack handle into the pump linkage.
- Use an up-and-down motion with the jack handle to raise the wheel completely off the ground.

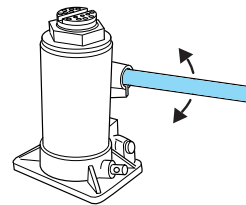
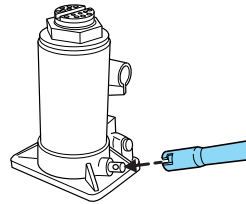

If your vehicle has single rear wheels, thread the lug nuts on the studs with the beveled face toward the wheel.

If your vehicle has dual rear wheels, thread the two element swiveling lug nuts on the studs with the flange facing toward the wheel.



## Roadside Emergencies

3. Use the lug nut wrench to screw the lug nut snugly against the wheel.
4. Lower the vehicle by turning the jack handle counterclockwise.
5. Remove the jack and fully tighten the lug nuts in the following pattern:

- 5-lug wheel

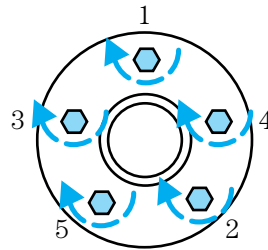

- 8-lug wheel



Never use wheels or lug nuts different than the original equipment as this could damage the wheel or mounting system. This damage could allow the wheels to come off while the vehicle is being driven.

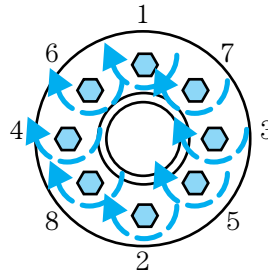

6. Install any wheel covers, ornaments or hub caps. Make sure they are screwed or snapped in place.
7. Stow the jack, handle and lug wrench.
8. Unblock the wheels.

On vehicles equipped with single rear wheels, retighten the lug nuts to the specified torque at 800 km (500 miles) of operation after any wheel change or any time the lug nuts are loosened.

On vehicles equipped with dual rear wheels, retighten the wheel lug nuts to the specified torque at 160 km (100 miles), and again at 800 km (500 miles) of new vehicle operation.

## Roadside Emergencies

Model	Bolt size	Wheel lug nut torque*	
		Nm	Lb-ft
E-150	1/2-20	135	100
E-250, E-350 and E-450	9/16-18	190	140
E-550	M14x1.5	200–225	150–165

\* Torque specifications are for nut and bolt threads free of dirt and rust. Do not use oil or grease on threads (E-550 vehicles, refer to following Note). Use only Ford recommended replacement fasteners.

**Note:** For E-550 vehicles, on all two-piece flat wheel nuts, apply motor oil between the flat washer and the nut. Do not apply motor oil to the wheel nut threads or the wheel stud threads.

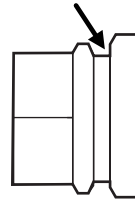

### Stowing the flat/spare tire

1. Lay the tire on the ground with the valve stem facing in the direction specified on the Tire Changing Instructions located with the jack hardware.
2. Slide the wheel partially under the vehicle and install the retainer through the wheel center. Pull on the cable to align the components at the end of the cable.
3. Turn the jack handle clockwise until the tire is raised to its stowed position underneath the vehicle. The effort to turn the jack handle increases significantly and the spare tire carrier ratchets or slips when the tire is raised to the maximum tightness. Tighten to the best of your ability, to the point where the ratchet/slip occurs, if possible. The spare tire carrier will not allow you to overtighten. If the spare tire carrier ratchets or slips with little effort, take the vehicle to your dealer for assistance at your earliest convenience.
4. Check that the tire lies flat against the frame and is properly tightened. Try to push or pull, then turn the tire to be sure it will not move. Loosen and retighten, if necessary. Failure to properly stow the spare tire may result in failure of the winch cable and loss of the tire.

## Roadside Emergencies

5. Repeat this tightness check procedure when servicing the spare tire pressure (every six months, per scheduled maintenance guide), or at any time that the spare tire is disturbed through service of other components.
6. If removed, install the spare tire lock (if equipped) into the bumper drive tube with the spare tire lock key (if equipped) and jack handle.

### JUMP STARTING YOUR VEHICLE



The gases around the battery can explode if exposed to flames, sparks, or lit cigarettes. An explosion could result in injury or vehicle damage.



Batteries contain sulfuric acid which can burn skin, eyes and clothing, if contacted.

**Do not attempt to push-start your vehicle. Automatic transmissions do not have push-start capability; also, the catalytic converter may become damaged.**

### Preparing your vehicle

When the battery is disconnected or a new battery is installed, the transmission must relearn its shift strategy. As a result, the transmission may have firm and/or soft shifts. This operation is considered normal and will not affect function or durability of the transmission. Over time, the adaptive learning process will fully update transmission operation.

1. **Use only a 12-volt supply to start your vehicle.**
2. Do not disconnect the battery of the disabled vehicle as this could damage the vehicle's electrical system.
3. Park the booster vehicle close to the hood of the disabled vehicle making sure the two vehicles **do not** touch. Set the parking brake on both vehicles and stay clear of the engine cooling fan and other moving parts.
4. Check all battery terminals and remove any excessive corrosion before you attach the battery cables. Ensure that vent caps are tight and level.
5. Turn the heater fan on in both vehicles to protect any electrical surges. Turn all other accessories off.

## Roadside Emergencies

### Connecting the jumper cables

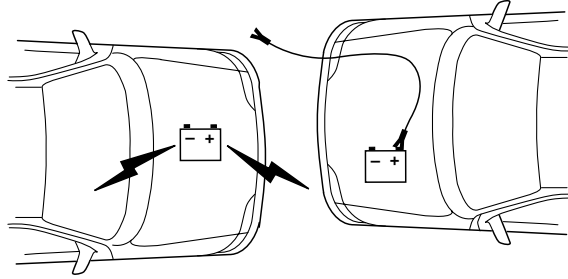

1. Connect the positive (+) booster cable to the positive (+) terminal of the discharged battery.

**Note:** In the illustrations, *lightning bolts* are used to designate the assisting (boosting) battery.

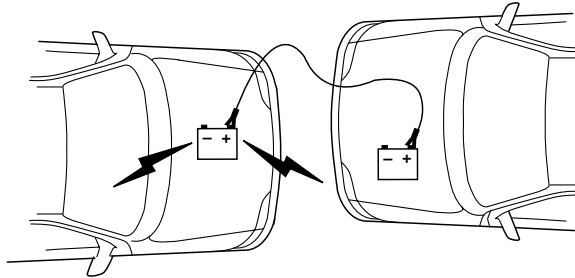

2. Connect the other end of the positive (+) cable to the positive (+) terminal of the assisting battery.

## Roadside Emergencies

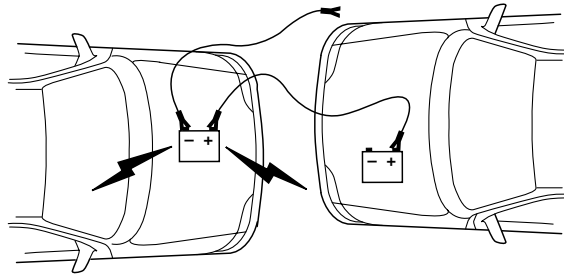

3. Connect the negative (-) cable to the negative (-) terminal of the assisting battery.

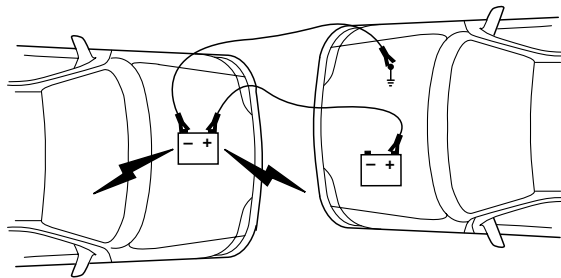

4. Make the final connection of the negative (-) cable to an exposed metal part of the stalled vehicle's engine, away from the battery and the carburetor/fuel injection system. **Do not** use fuel lines, engine rocker covers or the intake manifold as *grounding* points.

 Do not connect the end of the second cable to the negative (-) terminal of the battery to be jumped. A spark may cause an explosion of the gases that surround the battery.

5. Ensure that the cables are clear of fan blades, belts, moving parts of both engines, or any fuel delivery system parts.

### **Jump starting**

1. Start the engine of the booster vehicle and run the engine at moderately increased speed.
2. Start the engine of the disabled vehicle.
3. Once the disabled vehicle has been started, run both engines for an additional three minutes before disconnecting the jumper cables.

## Roadside Emergencies

### Removing the jumper cables

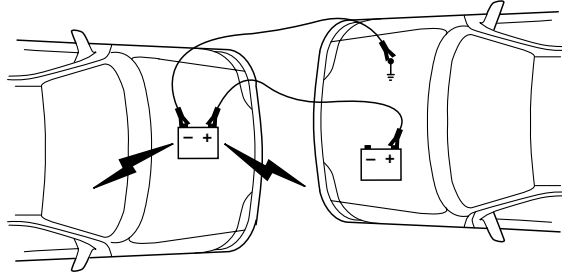

**Remove the jumper cables in the reverse order that they were connected.**

1. Remove the jumper cable from the *ground* metal surface.

**Note:** In the illustrations, *lightning bolts* are used to designate the assisting (boosting) battery.

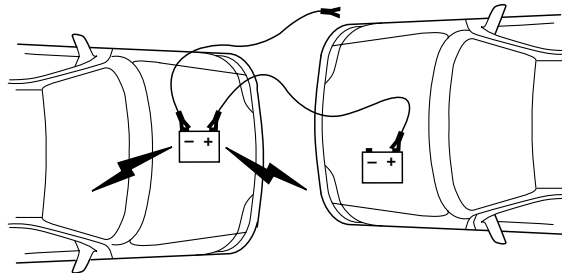

2. Remove the jumper cable on the negative (-) connection of the booster vehicle's battery.

## Roadside Emergencies

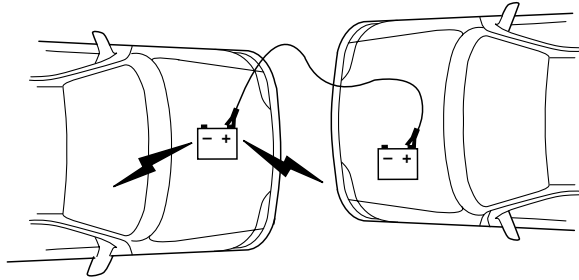

3. Remove the jumper cable from the positive (+) terminal of the booster vehicle's battery.

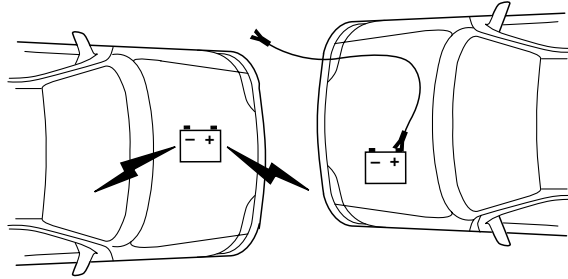

4. Remove the jumper cable from the positive (+) terminal of the disabled vehicle's battery.

After the disabled vehicle has been started and the jumper cables removed, allow it to idle for several minutes so the engine computer can *relearn* its idle conditions.

## Roadside Emergencies

### WRECKER TOWING

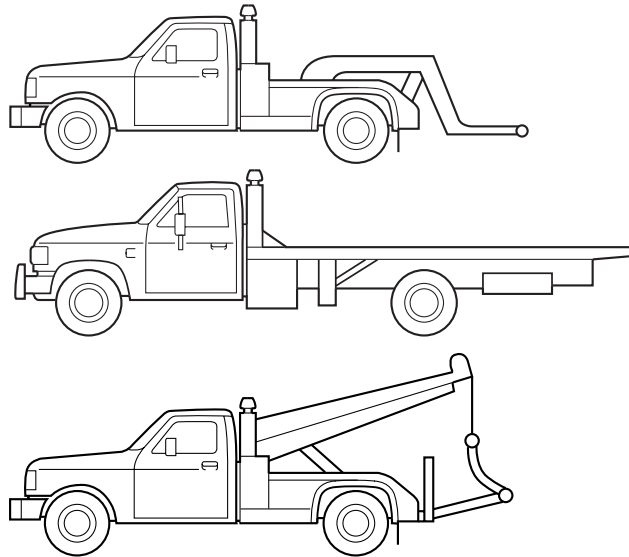

For towing, contact a professional towing service or your roadside assistance center.

Ford recommends your vehicle be towed with a wheel lift or flatbed. Do not tow with a slingbelt. Ford Motor Company has not approved a slingbelt towing procedure.

If your vehicle is equipped with an air dam and must be towed from the front, it is recommended that your vehicle be towed by wheel lift or flatbed equipment to prevent damage to the air dam.

**If the vehicle is towed by other means or incorrectly, vehicle damage may occur.**



## Customer Assistance

### GETTING THE SERVICES YOU NEED

#### At home

Ford Motor Company and Ford of Canada have authorized dealerships to service your vehicle. It is preferred that you return to the authorized dealer where your vehicle was purchased when warranty repairs are needed. However, you may also take your vehicle to another Ford Motor Company or Ford of Canada dealership authorized for warranty repairs. Certain warranty repairs require special training though, so not all dealers are authorized to perform all warranty repairs. That means that depending on the warranty repair needed, the vehicle may need to be taken to another dealer. If a particular dealership cannot assist you, then contact the Customer Relationship Center.

If you have questions or concerns, or are unsatisfied with the service you are receiving, follow these steps:

1. Contact your Sales Representative or Service Advisor at your selling/servicing dealership.
2. If your inquiry or concern remains unresolved, contact the Sales Manager or Service Manager at the dealership.
3. If the inquiry or concern cannot be resolved at the dealership level, please contact the Ford Customer Relationship Center.

#### Away from home

If you own a Ford or Mercury vehicle and are away from home when your vehicle needs service, or if you need more help than the dealership could provide, after following the steps described above, contact the Ford Customer Relationship Center to find an authorized dealership to help you.

In the United States:

Ford Motor Company  
Customer Relationship Center  
16800 Executive Plaza Drive  
P.O. Box 6248  
Dearborn, Michigan 48121  
1-800-392-3673 (FORD)  
(TDD for the hearing impaired: 1-800-232-5952)  
[www.ford.com](http://www.ford.com)

## Customer Assistance

In Canada:  
Customer Relationship Centre  
Ford Motor Company of Canada, Limited  
P.O. Box 2000  
Oakville, Ontario L6J 5E4  
1-800-565-3673 (FORD)  
[www.ford.ca](http://www.ford.ca)

If you own a Lincoln vehicle and are away from home when your vehicle needs service, or if you need more help than the dealership could provide, after following the steps described above, contact the Ford Customer Relationship Center to find an authorized dealership to help you.

In the United States:  
Ford Motor Company  
Customer Relationship Center  
16800 Executive Plaza Drive  
P.O. Box 6248  
Dearborn, Michigan 48121  
1-800-521-4140  
(TDD for the hearing impaired: 1-800-232-5952)  
[www.ford.com](http://www.ford.com)

In Canada:  
Customer Relationship Centre  
Ford Motor Company of Canada, Limited  
P.O. Box 2000  
Oakville, Ontario L6J 5E4  
1-800-565-3673 (FORD)  
[www.ford.ca](http://www.ford.ca)

In order to help you service your Ford or Lincoln Mercury vehicle, please have the following information available when contacting a Customer Relationship Center:

- Your telephone number (home and business)
- The name of the dealer and the city where the dealership is located
- The year and make of your vehicle
- The date of vehicle purchase
- The current odometer reading
- The vehicle identification number (VIN)

If you still have a complaint involving a warranty dispute, you may wish to contact the Dispute Settlement Board (U.S.).

## Customer Assistance

In some states (in the U.S.) you must directly notify Ford in writing before pursuing remedies under your state's warranty laws. Ford is also allowed a final repair attempt in some states.

In the United States, a warranty dispute must be submitted to the Dispute Settlement Board before taking action under the Magnuson-Moss Warranty Act, or to the extent allowed by state law, before pursuing replacement or repurchase remedies provided by certain state laws. This dispute handling procedure is not required prior to enforcing state created rights or other rights which are independent of the Magnuson-Moss Warranty Act or state replacement or repurchase laws.

### **FORD EXTENDED SERVICE PLAN**

You can get more protection for your new car or light truck by purchasing Ford Extended Service Plan (Ford ESP) coverage. Ford ESP is an optional service contract which is backed by Ford Motor Company or Ford Motor Service Company (in the U.S.) and Ford of Canada (in Canada). It provides the following:

- Benefits during the warranty period depending on the plan you purchase (such as: reimbursement for rentals; coverage for certain maintenance and wear items).
- Protection against covered repair costs after your Bumper-to-Bumper Warranty expires.

You may purchase Ford ESP from any participating Ford and Lincoln Mercury and Ford of Canada dealer. There are several plans available in various time, distance and deductible combinations which can be tailored to fit your own driving needs. Ford ESP also offers reimbursement benefits for towing and rental coverage.

When you buy Ford ESP, you receive Peace-of-Mind protection throughout the United States and Canada, provided by a network of more than 5,000 participating Ford or Lincoln Mercury and Ford of Canada dealers.

If you did not take advantage of the Ford Extended Service Plan at the time of purchasing your vehicle, you may still be eligible. Please contact your dealer for further information. Since this information is subject to change, please ask your dealer for complete details about Ford Extended Service Plan coverage options, or visit the Ford ESP website at [www.ford-esp.com](http://www.ford-esp.com).

## Customer Assistance

### THE DISPUTE SETTLEMENT BOARD (U.S. ONLY)

The Dispute Settlement Board is:

- an independent, third-party arbitration program for warranty disputes.
- available free to owners and lessees of qualifying Ford Motor Company vehicles.

The Dispute Settlement Board may not be available in all states. Ford Motor Company reserves the right to change eligibility limitations, modify procedures and/or to discontinue this service without notice and without incurring obligations per applicable state law.

### What kinds of cases does the Board review?

Unresolved warranty repair concerns or vehicle performance concerns as on Ford and Lincoln Mercury cars and Ford and Lincoln Mercury light trucks which are within the terms of any applicable written new vehicle warranty are eligible for review, except those involving:

- a non-Ford product
- a non-Ford dealership
- sales disputes between customer and dealer except those associated with warranty repairs or concerns with the vehicle's performance as designed
- a request for reimbursement of consequential expenses unless a service or product concern is being reviewed
- items not covered by the New Vehicle Limited Warranty (including maintenance and wear items)
- alleged personal injury/property damage claims
- cases currently in litigation
- vehicles not used primarily for family, personal or household purposes (except in states where the Dispute Settlement Board is required to review commercial vehicles)
- vehicles with non-U.S. warranties

Concerns are ineligible for review if the New Vehicle Limited Warranty has expired at receipt of your application and, in certain states eligibility is dependent upon the customer's possession of the vehicle.

Eligibility may differ according to state law. For example, see the unique brochures for California, West Virginia, Georgia and Wisconsin purchasers/lessees.

## Customer Assistance

### **Board membership**

The Board consists of:

- Three consumer representatives
- A Ford or Lincoln Mercury dealership representative

Consumer candidates for Board membership are recruited and trained by an independent consulting firm. The dealership Board member is chosen from Ford and Lincoln Mercury dealership management, recognized for their business leadership qualities.

### ***What the Board needs***

To have your case reviewed you must complete the application in the DSB brochure and mail it to the address provided on the application form. Some states will require you to use certified mail, with return receipt requested.

Your application is reviewed and, if it is determined to be eligible, you will receive an acknowledgment indicating:

- The file number assigned to your application.
- The toll-free phone number of the DSB's independent administrator.

Your dealership and a Ford Motor Company representative will then be asked to submit statements.

To properly review your case, the Board needs the following information:

- Legible copies of all documents and maintenance or repair orders relevant to the case.
- The year, make, model, and Vehicle Identification Number (VIN) listed on your vehicle ownership license.
- The date of repair(s) and mileage at the time of occurrence(s).
- The current mileage.
- The name of the dealer(s) who sold or serviced the vehicle.
- A brief description of your unresolved concern.
- A brief summary of the action taken by the dealer(s) and Ford Motor Company.
- The names (if known) of all the people you contacted at the dealership(s).
- A description of the action you expect to resolve your concern.

You will receive a letter of explanation if your application does not qualify for Board review.

## **Customer Assistance**

### ***Oral presentations***

If you would like to make an oral presentation, indicate YES to question 6 on the application. While it is your right to make an oral presentation before the Board, this is not a requirement and the Board will decide the case whether or not an oral presentation is made. An oral presentation may be requested by the Board as well.

### ***Making a decision***

Board members review all available information related to each complaint, including oral presentations, and arrive at a fair and impartial decision. Board review may be terminated at any time by either party.

Every effort is made to decide the case within 40 days of the date that all requested information is received by the Board. Since the Board generally meets once a month, it may take longer for the Board to consider some cases.

After a case is reviewed, the Board mails you a decision letter and a form on which to accept or reject the Board's decision. The decisions of the Board are binding on Ford (and, in some cases, on the dealer) but not on consumers who are free to pursue other remedies available to them under state or federal law.

### **To request a DSB Brochure/Application**

For a brochure/application, speak to your dealer or write/call to the Board at the following address/phone number:

Dispute Settlement Board  
P.O. Box 5120  
Southfield, MI 48086-5120  
1-800-428-3718

You may also contact the North American Customer Relationship Center at 1-800-392-3673 (Ford), TDD for the hearing impaired: 1-800-232-5952 or by writing to the Center at the following address:

Ford Motor Company  
Customer Relationship Center  
16800 Executive Plaza Drive  
P.O. Box 6248  
Dearborn, Michigan 48121

### **UTILIZING THE MEDIATION/ARBITRATION PROGRAM (CANADA ONLY)**

In those cases where you continue to feel that the efforts by Ford and the dealer to resolve a factory-related vehicle service concern have been

## Customer Assistance

unsatisfactory, Ford of Canada participates in an impartial third party mediation/arbitration program administered by the Canadian Motor Vehicle Arbitration Plan (CAMVAP).

The CAMVAP program is a straight-forward and relatively speedy alternative to resolve a disagreement when all other efforts to produce a settlement have failed. This procedure is without cost to you and is designed to eliminate the need for lengthy and expensive legal proceedings.

In the CAMVAP program, impartial third-party arbitrators conduct hearings at mutually convenient times and places in an informal environment. These impartial arbitrators review the positions of the parties, make decisions and, when appropriate, render awards to resolve disputes. CAMVAP decisions are fast, fair, and final; the arbitrator's award is binding both to you and Ford of Canada.

CAMVAP services are available in all territories and provinces. For more information, without charge or obligation, call your CAMVAP Provincial Administrator directly at 1-800-207-0685.

### **GETTING ASSISTANCE OUTSIDE THE U.S. AND CANADA**

Before exporting your vehicle to a foreign country, contact the appropriate foreign embassy or consulate. These officials can inform you of local vehicle registration regulations and where to find unleaded fuel.

If you cannot find unleaded fuel or can only get fuel with an anti-knock index lower than is recommended for your vehicle, contact a district or owner relations/customer relationship office.

The use of leaded fuel in your vehicle without proper conversion may damage the effectiveness of your emission control system and may cause engine knocking or serious engine damage. Ford Motor Company/Ford of Canada is not responsible for any damage caused by use of improper fuel.

In the United States, using leaded fuel may also result in difficulty importing your vehicle back into the U.S.

If your vehicle must be serviced while you are traveling or living in Central or South America, the Caribbean, or the Middle East, contact the nearest Ford dealership. If the dealership cannot help you, write or call:

FORD MOTOR COMPANY  
WORLDWIDE DIRECT MARKET OPERATIONS  
1555 Fairlane Drive  
Fairlane Business Park #3  
Allen Park, Michigan 48101  
U.S.A.  
Telephone: (313) 594-4857  
FAX: (313) 390-0804

## Customer Assistance

If you are in another foreign country, contact the nearest Ford dealership. If the dealership employees cannot help you, they can direct you to the nearest Ford affiliate office.

If you buy your vehicle in North America and then relocate outside of the U.S. or Canada, register your vehicle identification number (VIN) and new address with Ford Motor Company Worldwide Direct Market Operations.

### **ORDERING ADDITIONAL OWNER'S LITERATURE**

To order the publications in this portfolio, contact Helm, Incorporated at:

HELM, INCORPORATED  
P.O. Box 07150  
Detroit, Michigan 48207

Or call:

**For a free publication catalog, order toll free: 1-800-782-4356**

Monday-Friday 8:00 a.m. - 6:00 p.m. EST

Helm, Incorporated can also be reached by their website:  
[www.helminc.com](http://www.helminc.com).

*(Items in this catalog may be purchased by credit card, check or money order.)*

### **Obtaining a French owner's guide**

French Owner's Guides can be obtained from your dealer or by writing to Ford Motor Company of Canada, Limited, Service Publications, P.O. Box 1580, Station B, Mississauga, Ontario L4Y 4G3.

### **IN CALIFORNIA (U.S. ONLY)**

California Civil Code Section 1793.2(d) requires that, if a manufacturer or its representative is unable to repair a motor vehicle to conform to the vehicle's applicable express warranty after a reasonable number of attempts, the manufacturer shall be required to either replace the vehicle with one substantially identical or repurchase the vehicle and reimburse the buyer in an amount equal to the actual price paid or payable by the consumer (less a reasonable allowance for consumer use). The consumer has the right to choose whether to receive a refund or replacement vehicle.



## Customer Assistance

California Civil Code Section 1793.22(b) presumes that the manufacturer has had a reasonable number of attempts to conform the vehicle to its applicable express warranties if, within the first 18 months of ownership of a new vehicle or the first 29,000 km (18,000 miles), whichever occurs first:

1. Two or more repair attempts are made on the same nonconformity likely to cause death or serious bodily injury OR
2. Four or more repair attempts are made on the same nonconformity (a defect or condition that substantially impairs the use, value or safety of the vehicle) OR
3. The vehicle is out of service for repair of nonconformities for a total of more than 30 calendar days (not necessarily all at one time)

In the case of 1 or 2 above, the consumer must also notify the manufacturer of the need for the repair of the nonconformity at the following address:

Ford Motor Company  
16800 Executive Plaza Drive  
Mail Drop 3NE-B  
Dearborn, MI 48126

### REPORTING SAFETY DEFECTS (U.S. ONLY)

If you believe that your vehicle has a defect which could cause a crash or could cause injury or death, you should immediately inform the National Highway Traffic Safety Administration (NHTSA) in addition to notifying Ford Motor Company.

*Ford Motor Company*

If NHTSA receives similar complaints, it may open an investigation, and if it finds that a safety defect exists in a group of vehicles, it may order a recall and remedy campaign. However, NHTSA cannot become involved in individual problems between you, your dealer, or Ford Motor Company.

To contact NHTSA, you may either call the Auto Safety Hotline toll-free at 1-800-424-9393 (or 366-0123 in the Washington D.C. area) or write to:

NHTSA  
U.S. Department of Transportation  
Washington, D.C. 20590

You can also obtain other information about motor vehicle safety from the Hotline.

## Cleaning

### WASHING THE EXTERIOR

Wash your vehicle regularly with cool or lukewarm water and a neutral Ph shampoo, such as Motorcraft Detail Wash (ZC-3-A), which is available from your dealer.

- Never use strong household detergents or soap, such as dish washing or laundry liquid. These products can discolor and spot painted surfaces.
- Never wash a vehicle that is “hot to the touch” or during exposure to strong, direct sunlight.
- Always use a clean sponge or carwash mitt with plenty of water for best results.
- Dry the vehicle with a chamois or soft terry cloth towel in order to eliminate water spotting.
- It is especially important to wash the vehicle regularly during the winter months, as dirt and road salt are difficult to remove and cause damage to the vehicle.
- Immediately remove items such as gasoline, diesel fuel, bird droppings and insect deposits because they can cause damage to the vehicle’s paintwork and trim over time.
- Remove any exterior accessories, such as antennas, before entering a car wash.
- **Suntan lotions and insect repellents can damage any painted surface; if these substances come in contact with your vehicle, wash off as soon as possible.**
- **If your vehicle is equipped with running boards, do not use rubber, plastic and vinyl protectant products on the running board surface, as the area may become slippery.**

### WAXING

Applying a polymer paint sealant to your vehicle every six months will assist in reducing minor scratches and paint damage.

- Wash the vehicle first.
- Do not use waxes that contain abrasives.
- Do not allow paint sealant to come in contact with any non-body (low-gloss black) colored trim, such as grained door handles, roof racks, bumpers, side moldings, mirror housings or the windshield cowl area. The paint sealant will “gray” or stain the parts over time.

### PAINT CHIPS

Your dealer has touch-up paint and sprays to match your vehicle's color. Take your color code (printed on a sticker in the driver's door jam) to your dealer to ensure you get the correct color.

- Remove particles such as bird droppings, tree sap, insect deposits, tar spots, road salt and industrial fallout before repairing paint chips.
- Always read the instructions before using the products.

### ALUMINUM WHEELS AND COVERS

Aluminum wheel rims or covers are coated with a clearcoat paint finish. In order to maintain their shine:

- Clean weekly with Motorcraft Wheel and Tire Cleaner (ZC-37-A), which is available from your dealer. Heavy dirt and brake dust accumulation may require agitation with a sponge. Rinse thoroughly with a strong stream of water.
- Never apply any cleaning chemical to hot or warm wheel rims or covers.
- Some automatic car washes may cause damage to the finish on your wheel rims or covers. Chemical-strength cleaners, or cleaning chemicals, in combination with brush agitation to remove brake dust and dirt, could wear away the clearcoat finish over time.
- Do not use hydrofluoric acid-based or high caustic-based wheel cleaners, steel wool, fuels or strong household detergent.
- To remove tar and grease, use Ford Extra Strength Tar and Road Oil Removal (B7A-19520-AA), available from your dealer.

### ENGINE

Engines are more efficient when they are clean because grease and dirt buildup keep the engine warmer than normal. When washing:

- Take care when using a power washer to clean the engine. The high-pressure fluid could penetrate the sealed parts and cause damage.
- Do not spray a hot engine with cold water to avoid cracking the engine block or other engine components.
- Spray Motorcraft Engine Shampoo and Degreaser (ZC-20) on all parts that require cleaning and pressure rinse clean.

## Cleaning

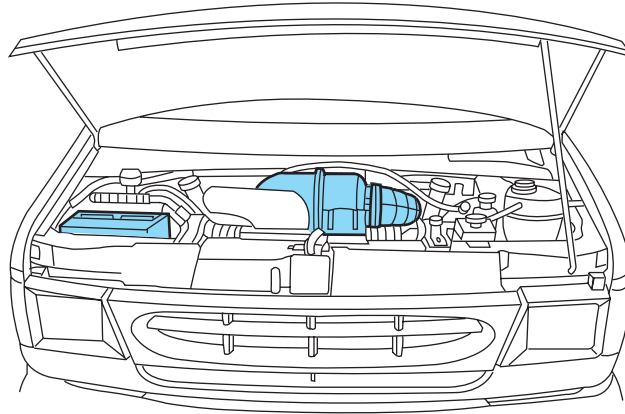

- Cover the highlighted areas to prevent water damage when cleaning the engine.
- Never wash or rinse the engine while it is running; water in the running engine may cause internal damage.

### **PLASTIC (NON-PAINTED) EXTERIOR PARTS**

Use only approved products to clean plastic parts. These products are available from your dealer.

- For routine cleaning, use Motorcraft Detail Wash (ZC-3-A).
- If tar or grease spots are present, use Ford Extra Strength Tar and Road Oil Removal (B7A-19520-AA).

### **WINDOWS AND WIPER BLADES**

The windshield, rear window and wiper blades should be cleaned regularly. If the wiper does not wipe properly, substances on the windshield, rear window or the wiper blades may be the cause. These may include hot wax treatments used by commercial car washes, tree sap, or other organic contamination. To clean these items, please follow these tips:

- The windshield or rear window may be cleaned with a non-abrasive cleaner such as Motorcraft Ultra Clear Spray Glass Cleaner (ZC-23), available from your dealer.
- Do not use abrasives, as they may cause scratches.
- Do not use fuel, kerosene, or paint thinner to clean any parts.

## Cleaning

- Wiper blades can be cleaned with isopropyl (rubbing) alcohol or windshield washer solution. Be sure to replace wiper blades when they appear worn or do not function properly.

### INSTRUMENT PANEL AND CLUSTER LENS

Clean the instrument panel with a damp cloth, then dry with a dry cloth.

- Avoid cleaners or polish that increase the gloss of the upper portion of the instrument panel. The dull finish in this area helps protect the driver from undesirable windshield reflection.



Do not use chemical solvents or strong detergents when cleaning the steering wheel or instrument panel to avoid contamination of the air bag system.

- Be certain to wash or wipe your hands clean if you have been in contact with certain products such as insect repellent and suntan lotion in order to avoid possible damage to the painted surfaces.

### INTERIOR TRIM

- Clean the interior trim areas with a damp cloth, then dry by wiping with a dry, soft, clean cloth.
- Do not use household or glass cleaners as these may damage the finish.

### INTERIOR

For fabric, carpets, cloth seats and safety belts:

- Remove dust and loose dirt with a vacuum cleaner.
- Remove light stains and soil with Ford Extra Strength Upholstery Cleaner (E8AZ-19523-AA).
- If grease or tar is present on the material, spot-clean the area first with Motorcraft Spot and Stain Remover (ZC-14).
- Never saturate the seat covers with cleaning solution.
- Do not use household cleaning products or glass cleaners, which can stain and discolor the fabric and affect the flame retardant abilities of the seat materials.



Do not use cleaning solvents, bleach or dye on the vehicle's seatbelts, as these actions may weaken the belt webbing.

## Cleaning

### LEATHER SEATS (IF EQUIPPED)

Your leather seating surfaces have a clear, protective coating over the leather.

- To clean, use a soft cloth with Motorcraft Deluxe Leather and Vinyl Cleaner (ZC-11-A). Dry the area with a soft cloth.
- To help maintain its resiliency and color, use the Motorcraft Deluxe Leather Care Kit (ZC-11-D), available from your authorized dealer.
- Do not use household cleaning products, alcohol solutions, solvents or cleaners intended for rubber, vinyl and plastics, or oil/petroleum-based leather conditioners. These products may cause premature wearing of the clear, protective coating.

### UNDERBODY

Flush the complete underside of your vehicle frequently. Keep body and door drain holes free from packed dirt.

### FORD, LINCOLN AND MERCURY CAR CARE PRODUCTS

Your Ford, Lincoln or Mercury dealer has many quality products available to clean your vehicle and protect its finishes. These quality products have been specifically engineered to fulfill your automotive needs; they are custom designed to complement the style and appearance of your vehicle. Each product is made from high quality materials that meet or exceed rigid specifications. For best results, use the following products or products of equivalent quality:

Motorcraft Custom Clearcoat Polish (ZC-8-A)

Ford Custom Vinyl Protectant\* (not available in Canada)  
(F2AZ-19530-A)

Motorcraft Vinyl Cleaner (Canada only) (CXC-93)

Motorcraft Vinyl Conditioner (Canada only) (CXC-94)

Motorcraft Deluxe Leather and Vinyl Cleaner (not available in Canada)  
(ZC-11-A)

Ford Extra Strength Tar and Road Oil Remover\* (not available in Canada)  
(B7A-19520-AA)

Ford Extra Strength Upholstery Cleaner (not available in Canada)  
(E8AZ-19523-AA)

Motorcraft Custom Bright Metal Cleaner (ZC-15)

Motorcraft Wheel and Tire Cleaner (ZC-37-A)

## Cleaning

Motorcraft Dash and Vinyl Cleaner (ZC-38-A)

Motorcraft Car Care Kit (ZC-26)

Ford Premium Car Wash Concentrate (F2SZ-19523-WC)

Motorcraft Carlite Glass Cleaner (Canada only) (CXC-100)

Motorcraft Spot and Stain Remover (ZC-14)

Motorcraft Detail Wash (ZC-3-A)

Motorcraft Tire Detailer (ZC-28)

Motorcraft Triple Clean (ZC-13)

Motorcraft Ultra-Clear Spray Glass Cleaner (not available in Canada)  
(ZC-23)

Motorcraft Engine Shampoo and Degreaser (ZC-20)

\* May be sold with the Motorcraft name

## Maintenance and Specifications

### SERVICE RECOMMENDATIONS

To help you service your vehicle:

- We highlight do-it-yourself items in the engine compartment for easy location.
- We provide a scheduled maintenance guide which makes tracking routine service easy.

If your vehicle requires professional service, your dealership can provide the necessary parts and service. Check your *Warranty Guide/Owner Information Guide* to find out which parts and services are covered.

Use only recommended fuels, lubricants, fluids and service parts conforming to specifications. Motorcraft parts are designed and built to provide the best performance in your vehicle.

### PRECAUTIONS WHEN SERVICING YOUR VEHICLE

- Do not work on a hot engine.
- Make sure that nothing gets caught in moving parts.
- Do not work on a vehicle with the engine running in an enclosed space, unless you are sure you have enough ventilation.
- Keep all open flames and other lit material away from the battery and all fuel related parts.

#### Working with the engine off

1. Set the parking brake and shift to P (Park).
2. Turn off the engine and remove the key.
3. Block the wheels.

#### Working with the engine on

1. Set the parking brake and shift to P (Park).
2. Block the wheels.

**Note:** Do not start your engine with the air cleaner removed and do not remove it while the engine is running.



## Maintenance and Specifications

### OPENING THE HOOD

1. Inside the vehicle, pull the hood release handle located under the bottom left corner of the instrument panel.

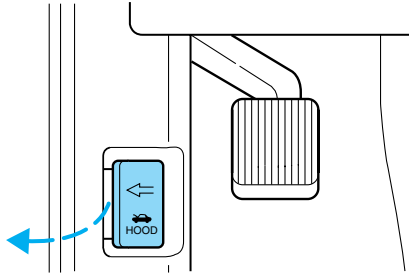

2. Go to the front of the vehicle and release the auxiliary latch that is located in the center top of the grill.

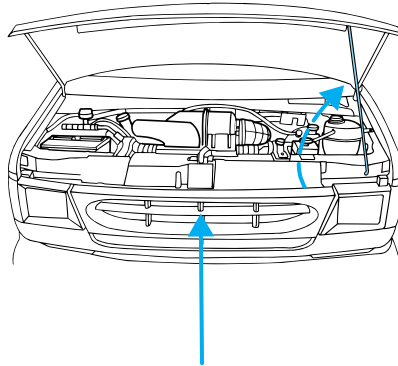

3. Lift the hood and secure it with the prop rod.

### IDENTIFYING COMPONENTS IN THE ENGINE COMPARTMENT

#### Engine compartment component locations

Refer to the *7.3 Liter Power Stroke Direct Injection Turbo Diesel Owner's Guide Supplement* for diesel engine component locations.

## Maintenance and Specifications

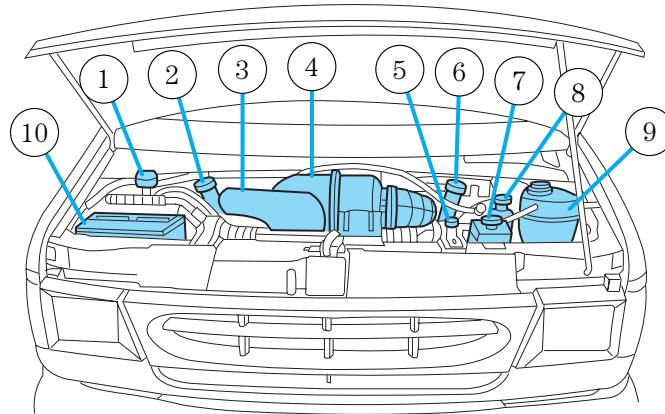

- |  |  |
|--|--|
| 1. Windshield washer fluid reservoir             | 5. Engine oil dipstick                         |
| 2. Engine oil filler cap (except 4.2L V6 engine) | 6. Engine oil filler cap (4.2L V6 engine only) |
| 3. Automatic transmission fluid dipstick         | 7. Power steering fluid reservoir              |
| 4. Air filter assembly                           | 8. Brake fluid reservoir                       |
|  | 9. Engine coolant reservoir                    |
|  | 10. Battery                                    |

### WINDSHIELD WASHER FLUID

Add fluid to fill the reservoir if the level is low. In very cold weather, do not fill the reservoir completely.

Only use a washer fluid that meets Ford specification WSB-M8B16-A2. Refer to *Lubricant specifications* in this chapter.

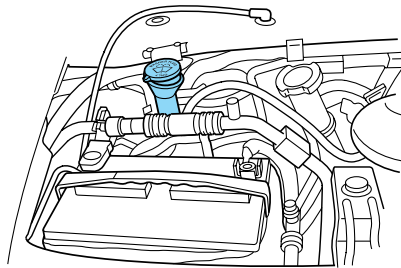

State or local regulations on volatile organic compounds may restrict the use of methanol, a common windshield washer antifreeze additive. Washer fluids containing non-methanol antifreeze agents should be used only if they provide cold weather protection without damaging the vehicle's paint finish, wiper blades or washer system.

## Maintenance and Specifications



If you operate your vehicle in temperatures below 4.5° C (40° F), use washer fluid with antifreeze protection. Failure to use washer fluid with antifreeze protection in cold weather could result in impaired windshield vision and increase the risk of injury or accident.

**Note:** Do not put washer fluid in the engine coolant reservoir. Washer fluid placed in the cooling system may harm engine and cooling system components.

### ENGINE OIL

#### Checking the engine oil

Refer to the scheduled maintenance guide for the appropriate intervals for checking the engine oil.

1. Make sure the vehicle is on level ground.
2. Turn the engine off and wait a few minutes for the oil to drain into the oil pan.
3. Set the parking brake and ensure the gearshift is securely latched in P (Park).
4. Open the hood. Protect yourself from engine heat.
5. Locate and carefully remove the engine oil level indicator (dipstick).

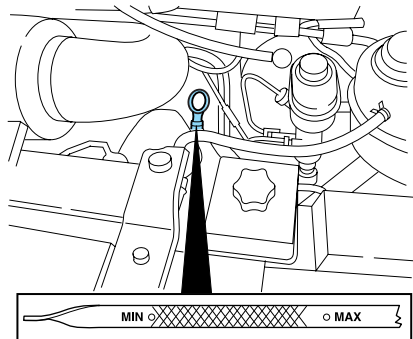

6. Wipe the indicator clean. Insert the indicator fully, then remove it again.

- If the oil level is **between the MIN and MAX marks**, the oil level is acceptable. **DO NOT ADD OIL.**

## Maintenance and Specifications

- If the oil level is below the MIN mark, add enough oil to raise the level within the MIN-MAX range.

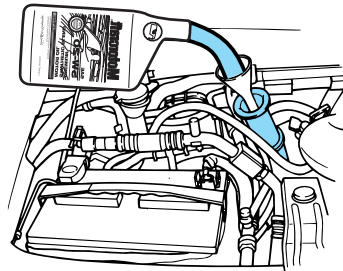

- Oil levels above the MAX mark may cause engine damage. Some oil must be removed from the engine by a service technician.
7. Put the indicator back in and ensure it is fully seated.

### Adding engine oil

1. Check the engine oil. For instructions, refer to *Checking the engine oil* in this chapter.
2. If the engine oil level is not within the normal range, add only certified engine oil of the recommended viscosity. Remove the engine oil filler cap and use a funnel to pour the engine oil into the opening.
3. Recheck the engine oil level. Make sure the oil level is not above the MAX mark on the engine oil level indicator (dipstick).
4. Install the indicator and ensure it is fully seated.
5. Fully install the engine oil filler cap by turning the filler cap clockwise 1/4 of a turn until three clicks are heard or until the cap is fully seated.

**To avoid possible oil loss, DO NOT operate the vehicle with the engine oil level indicator and/or the engine oil filler cap removed.**

## Maintenance and Specifications

### Engine oil and filter recommendations

Look for this certification trademark.

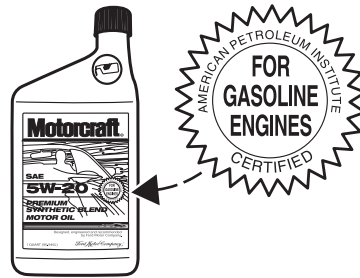

### ***SAE 5W-20 engine oil is recommended.***

Only use oils “Certified For Gasoline Engines” by the American Petroleum Institute (API). Use Motorcraft or an equivalent oil meeting Ford specification WSS-M2C153-H. **SAE 5W-20 oil provides optimum fuel economy and durability performance meeting all requirements for your vehicle’s engine.**

Do not use supplemental engine oil additives, oil treatments or engine treatments. They are unnecessary and could, under certain conditions, lead to engine damage which is not covered by your warranty.

Change your engine oil and filter according to the appropriate schedule listed in the scheduled maintenance guide.

Ford production and aftermarket (Motorcraft) oil filters are designed for added engine protection and long life. If a replacement oil filter is used that does not meet Ford material and design specifications, start-up engine noises or knock may be experienced.

It is recommended you use the appropriate Motorcraft oil filter (or another brand meeting Ford specifications) for your engine application.

## Maintenance and Specifications

### BATTERY

Your vehicle is equipped with a Motorcraft maintenance-free battery which normally does not require additional water during its life of service.

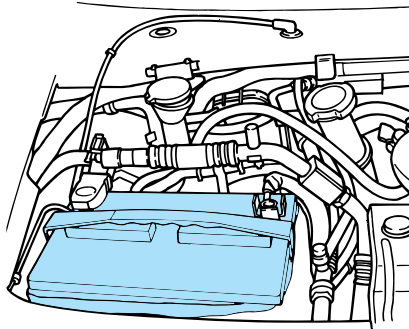

However, for severe usage or in high temperature climates and for frame mounted batteries, check the battery electrolyte level. Refer to the scheduled maintenance guide for the service interval schedules.

**Keep the electrolyte level in each cell up to the “level indicator”. Do not overfill the battery cells.**

If the electrolyte level in the battery is low, you can add plain tap water to the battery, as long as you do not use hard water (water with a high mineral or alkali content). If possible, however, try to only fill the battery cells with distilled water. If the battery needs water often, have the charging system checked.

**If your battery has a cover/shield, make sure it is reinstalled after the battery has been cleaned or replaced.**

For longer, trouble-free operation, keep the top of the battery clean and dry. Also, make certain the battery cables are always tightly fastened to the battery terminals.

If you see any corrosion on the battery or terminals, remove the cables from the terminals and clean with a wire brush. You can neutralize the acid with a solution of baking soda and water.

When the battery is disconnected or a new battery installed, the transmission must learn its adaptive strategy. As a result of this, the transmission may shift firmly. This operation is considered normal and will fully update transmission operation to its optimum shift feel.



Batteries normally produce explosive gases which can cause personal injury. Therefore, do not allow flames, sparks or lighted substances to come near the battery. When working near the battery, always shield your face and protect your eyes. Always provide proper ventilation.

## Maintenance and Specifications



When lifting a plastic-cased battery, excessive pressure on the end walls could cause acid to flow through the vent caps, resulting in personal injury and/or damage to the vehicle or battery. Lift the battery with a battery carrier or with your hands on opposite corners.



Keep batteries out of reach of children. Batteries contain sulfuric acid. Avoid contact with skin, eyes or clothing. Shield your eyes when working near the battery to protect against possible splashing of acid solution. In case of acid contact with skin or eyes, flush immediately with water for a minimum of 15 minutes and get prompt medical attention. If acid is swallowed, call a physician immediately.



Battery posts, terminals and related accessories contain lead and lead compounds. **Wash hands after handling.**

For information on transmission operation after the battery has been disconnected see “Shift strategy” in the driving section.

Because your vehicle’s engine is electronically controlled by a computer, some control conditions are maintained by power from the battery. When the battery is disconnected or a new battery is installed, the engine must relearn its idle and fuel trim strategy for optimum driveability and performance. To begin this process:

1. With the vehicle at a complete stop, set the parking brake.
2. Put the gearshift in P (Park), turn off all accessories and start the engine.
3. Run the engine until it reaches normal operating temperature.
4. Allow the engine to idle for at least one minute.
5. Turn the A/C on and allow the engine to idle for at least one minute.
6. Release the parking brake. With your foot on the brake pedal and with the A/C on, put the vehicle in D (Drive) and allow the engine to idle for at least one minute.
7. Drive the vehicle to complete the relearning process.
  - The vehicle may need to be driven 16 km (10 miles) or more to relearn the idle and fuel trim strategy.
  - **If you do not allow the engine to relearn its idle trim, the idle quality of your vehicle may be adversely affected until the idle trim is eventually relearned.**

## Maintenance and Specifications

If the battery has been disconnected or a new battery has been installed, the clock and radio settings must be reset once the battery is reconnected.

- Always dispose of automotive batteries in a responsible manner. Follow your local authorized standards for disposal. Call your local authorized recycling center to find out more about recycling automotive batteries.

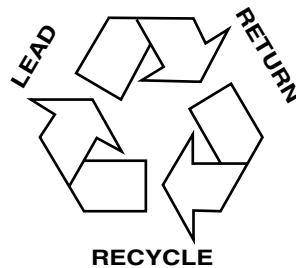

### Disconnecting dual batteries (if equipped)

The primary battery is located under the hood.

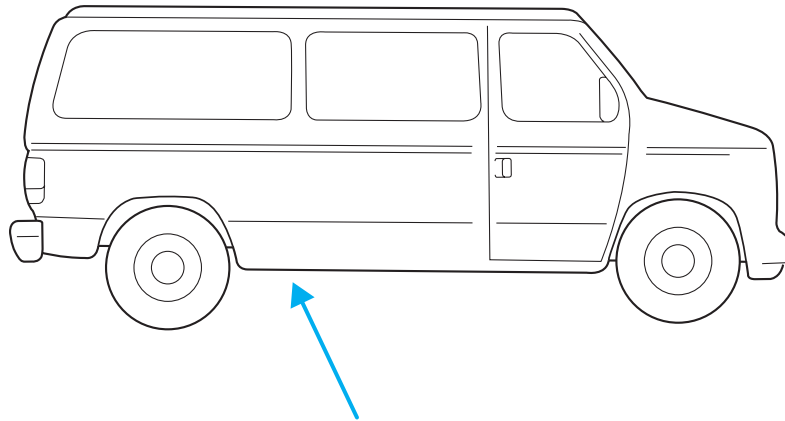

The auxiliary battery is located on the passenger side frame rail.



## Maintenance and Specifications

### *Gasoline engines*

#### **Disconnect:**

1. Disconnect the primary battery ground cable.

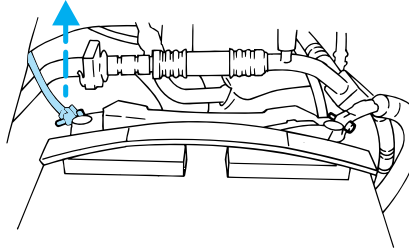

2. Disconnect the auxiliary battery frame ground.

- Remove the ground bolt.
- Pull the cable away from the frame and make sure that the cable does not contact the frame.

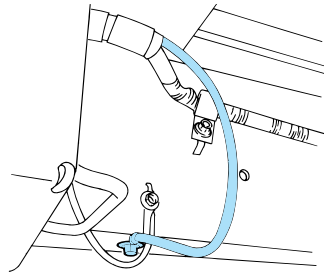

#### **Connect:**

1. Reconnect the auxiliary battery frame ground.

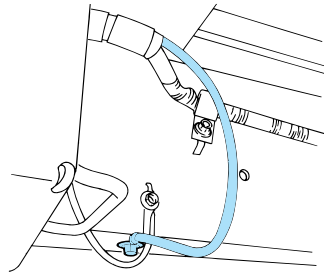

## Maintenance and Specifications

2. Reconnect the primary battery ground cable.

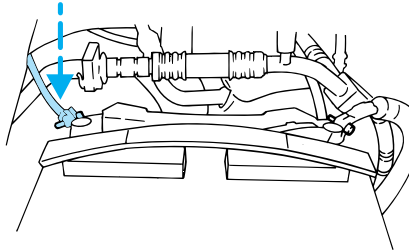

### ***Diesel engines***

#### **Disconnect:**



Secondary positive cable remains energized after disconnection. Make sure the tool does not contact any ground surface.

1. Disconnect the secondary positive cable from the primary battery terminal.

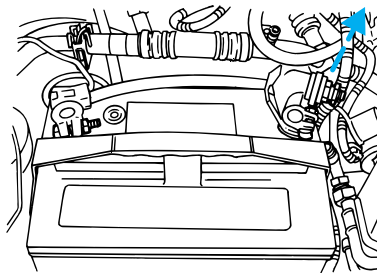

2. Wrap the secondary positive cable with a non-conductive material to insulate.

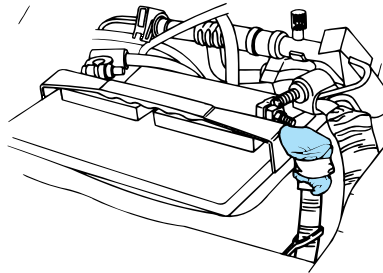

## Maintenance and Specifications

3. Disconnect the primary battery ground cable.
4. Disconnect the primary battery positive cable.

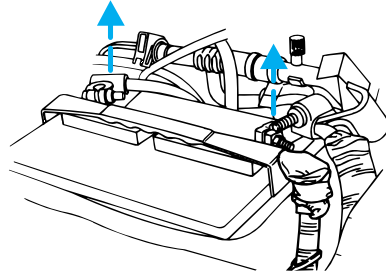

### Connect:



Secondary positive cable remains energized after disconnection. make sure the tool does not contact any ground surface.

1. Reconnect the primary battery positive cable.
2. Reconnect the primary battery ground cable.

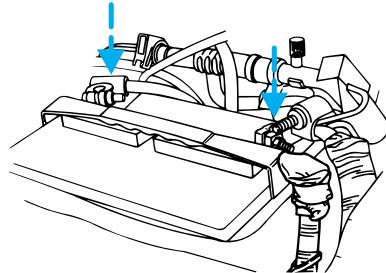

3. Unwrap the secondary positive cable and reconnect to the primary battery terminal.

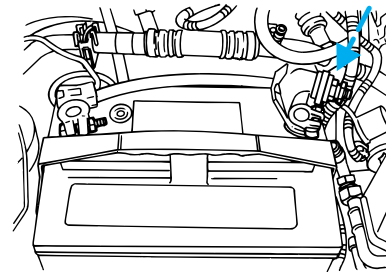

## ENGINE COOLANT

### Checking engine coolant

The concentration and level of engine coolant should be checked at the mileage intervals listed in the scheduled maintenance guide. The coolant

## Maintenance and Specifications

concentration should be maintained at 50/50 coolant and distilled water, which equates to a freeze point of  $-36^{\circ}\text{C}$  ( $-34^{\circ}\text{F}$ ). Coolant concentration testing is possible with a hydrometer or antifreeze tester (such as the Rotunda Battery and Antifreeze Tester, 014-R1060). The level of coolant should be maintained at the “cold full” or “cold fill range” level in the coolant reservoir. If the level falls below, add coolant per the instructions in the *Adding engine coolant* section.

Your vehicle was factory-filled with a 50/50 engine coolant and water concentration. If the concentration of coolant falls below 40% or above 60%, the engine parts could become damaged or not work properly. **A 50–50 mixture of coolant and water provides the following:**

- **Freeze protection down to  $-36^{\circ}\text{C}$  ( $-34^{\circ}\text{F}$ ).**
- **Boiling protection up to  $129^{\circ}\text{C}$  ( $265^{\circ}\text{F}$ ).**
- **Protection against rust and other forms of corrosion.**
- **Enables calibrated gauges to work properly.**

When the engine is cold, check the level of the engine coolant in the reservoir.

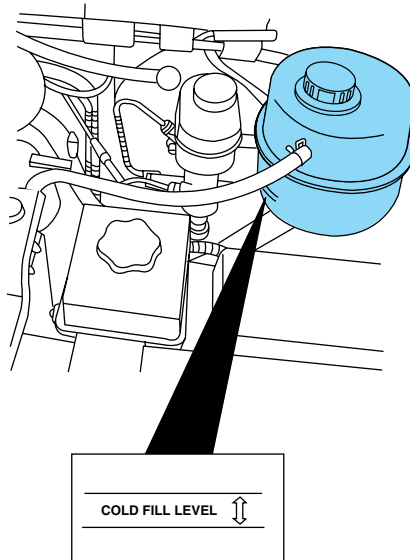

- The engine coolant should be at the “cold fill level” or within the “cold fill range” as listed on the engine coolant reservoir (depending upon application).

## Maintenance and Specifications

- Refer to the Scheduled Maintenance Guide for service interval schedules.
- Be sure to read and understand *Precautions when servicing your vehicle* in this chapter.

If the engine coolant has not been checked at the recommended interval, the engine coolant reservoir may become low or empty. If the reservoir is low or empty, add engine coolant to the reservoir. Refer to *Adding engine coolant* in this chapter.

**Note:** Automotive fluids are not interchangeable; do not use engine coolant, antifreeze or windshield washer fluid outside of its specified function and vehicle location.

### Adding engine coolant

When adding coolant, make sure it is a 50/50 mixture of engine coolant and distilled water. Add the mixture to the coolant reservoir, **when the engine is cool**, until the appropriate fill level is obtained.



Do not add engine coolant when the engine is hot. Steam and scalding liquids released from a hot cooling system can burn you badly. Also, you can be burned if you spill coolant on hot engine parts.



Do not put engine coolant in the windshield washer fluid container. If sprayed on the windshield, engine coolant could make it difficult to see through the windshield.

The cooling system in your vehicle is filled with either green-colored Motorcraft Premium Engine Coolant meeting Ford specification ESE-M97B44-A or yellow-colored Motorcraft Premium Gold Engine Coolant meeting Ford Specification WSS-M97B51-A1. To determine your vehicle's coolant type (color), check your coolant reservoir.

- **Add Motorcraft Premium Engine Coolant (green-colored), VC-4-A (U.S.) or CXC-10 (Canada) or Motorcraft Premium Gold Engine Coolant (yellow-colored), VC-7-A (VC-7-B in Oregon), depending on the type of coolant originally equipped in your vehicle.** If you are unsure which type of coolant your vehicle requires, check your coolant reservoir or contact your local dealer.

**Note:** Use of Motorcraft Cooling System Stop Leak Pellets, VC-6, darkens the color of Motorcraft Premium Gold Engine Coolant from yellow to golden tan.

- **Do not add/mix an orange-colored, extended life coolant such as Motorcraft Speciality Orange Engine Coolant, VC-2 (US) or**

## Maintenance and Specifications

**CXC-209 (Canada), meeting Ford specification WSS-M97B44-D with the factory-filled coolant.** Mixing Motorcraft Speciality Orange Engine Coolant or any orange-colored extended life product with your factory filled coolant can result in degraded corrosion protection.

- A large amount of water without engine coolant may be added, in case of emergency, to reach a vehicle service location. In this instance, the cooling system must be drained and refilled with a 50/50 mixture of engine coolant and distilled water as soon as possible. Water alone (without engine coolant) can cause engine damage from corrosion, overheating or freezing.
- **Do not use alcohol, methanol, brine or any engine coolants mixed with alcohol or methanol antifreeze (coolant).** Alcohol and other liquids can cause engine damage from overheating or freezing.
- **Do not add extra inhibitors or additives to the coolant.** These can be harmful and compromise the corrosion protection of the engine coolant.
- **Do not mix with recycled coolant unless from a Ford-approved recycling process (see *Use of Recycled engine coolant* section).**

For vehicles with overflow coolant systems with a non-pressurized cap on the coolant recovery system, add coolant to the coolant recovery reservoir when the engine is cool. Add the proper mixture of coolant and water to the “cold full” level. For all other vehicles, which have a coolant degas system with a pressurized cap, or if it is necessary to remove the coolant pressure relief cap on the radiator of a vehicle with an overflow system, follow these steps to add engine coolant.



To reduce the risk of personal injury, make sure the engine is cool before unscrewing the coolant pressure relief cap. The cooling system is under pressure; steam and hot liquid can come out forcefully when the cap is loosened slightly.

1. Before you begin, turn the engine off and let it cool.
2. When the engine is cool, wrap a thick cloth around the coolant pressure relief cap on the coolant reservoir (an opaque plastic bottle). Slowly turn cap counterclockwise (left) until pressure begins to release.
3. Step back while the pressure releases.
4. When you are sure that all the pressure has been released, use the cloth to turn it counterclockwise and remove the cap.

## Maintenance and Specifications

5. Fill the coolant reservoir slowly with the proper coolant mixture (see above), to within the “cold fill range” or the “cold full” level on the reservoir. If you removed the radiator cap in an overflow system, fill the radiator until the coolant is visible and radiator is almost full.

6. Replace the cap. Turn until tightly installed. (Cap must be tightly installed to prevent coolant loss.)

After any coolant has been added, check the coolant concentration, refer to *Checking Engine Coolant* section. If the concentration is not 50/50 (protection to  $-34^{\circ}\text{F}/-36^{\circ}\text{C}$ ), drain some coolant and adjust the concentration. It may take several drains and additions to obtain a 50/50 coolant concentration.

Whenever coolant has been added, the coolant level in the coolant reservoir should be checked the next few times you drive the vehicle. If necessary, add enough 50/50 concentration of engine coolant and distilled water to bring the liquid level to the proper level.

If you have to add more than 1.0 liter (1.0 quart) of engine coolant per month, have your dealer check the engine cooling system. Your cooling system may have a leak. Operating an engine with a low level of coolant can result in engine overheating and possible engine damage.

### Recycled engine coolant

Ford Motor Company recommends the use of a recycled engine coolant produced by Ford-approved processes in vehicles originally equipped with Motorcraft Premium Engine Coolant (green-colored). However, not all coolant recycling processes produce coolant that meets Ford specification ESE-M97B44-A. Use of such coolant may harm the engine and cooling system components.

Ford Motor Company does NOT recommend the use of recycled engine coolant in vehicles originally equipped with Motorcraft Premium Gold Engine Coolant since a Ford-approved recycling process is not yet available.



Used engine coolant should be disposed of in an appropriate manner. Follow your community’s regulations and standards for recycling and disposing of automotive fluids.

### Coolant refill capacity

To find out how much fluid your vehicle’s cooling system can hold, refer to *Refill capacities* in this chapter.

Fill your engine coolant reservoir as outlined in *Adding engine coolant* in this chapter.

## Maintenance and Specifications

### Severe climates

If you drive in extremely cold climates (less than  $-36^{\circ}\text{C}$  [ $-34^{\circ}\text{F}$ ):

- **It may be necessary to increase the coolant concentration above 50%.**
- **NEVER increase the coolant concentration above 60%.**
- **Increased engine coolant concentrations above 60% will decrease the overheat protection characteristics of the engine coolant and may cause engine damage.**
- **Refer to the chart on the coolant container to ensure the coolant concentration in your vehicle will provide adequate freeze protection at the temperatures in which you drive in the winter months.**

If you drive in extremely hot climates:

- **It is still necessary to maintain the coolant concentration above 40%.**
- **NEVER decrease the coolant concentration below 40%.**
- **Decreased engine coolant concentrations below 40% will decrease the corrosion protection characteristics of the engine coolant and may cause engine damage.**
- **Decreased engine coolant concentrations below 40% will decrease the freeze protection characteristics of the engine coolant and may cause engine damage.**
- **Refer to the chart on the coolant container to ensure the coolant concentration in your vehicle will provide adequate protection at the temperatures in which you drive.**

Vehicles driven year-round in non-extreme climates should use a 50/50 mixture of engine coolant and distilled water for optimum cooling system and engine protection.

### What you should know about fail-safe cooling (if equipped)



If the engine coolant supply is depleted, this feature allows the vehicle to be driven temporarily before incremental component damage is incurred. The “fail-safe” distance depends on ambient temperatures, vehicle load and terrain.



## Maintenance and Specifications

### How fail-safe cooling works

If the engine begins to overheat:

- The engine coolant temperature gauge will move to the red (hot) area.
- The  and  symbol will illuminate.
- The *Service Engine Soon* indicator light will illuminate.

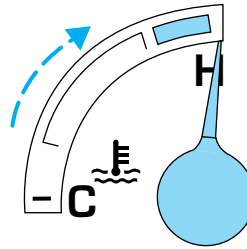

If the engine reaches a preset over-temperature condition, the engine will automatically switch to alternating cylinder operation. Each disabled cylinder acts as an air pump and cools the engine.

When this occurs the vehicle will still operate. However:

- The engine power will be limited.
- The air conditioning system will be disabled.

Continued operation will increase the engine temperature and the engine will completely shut down, causing steering and braking effort to increase.

Once the engine temperature cools, the engine can be re-started. Take your vehicle to a service facility as soon as possible to minimize engine damage.

### When fail-safe mode is activated

You have limited engine power when in the fail-safe mode, so drive the vehicle with caution. The vehicle will not be able to maintain high-speed operation and the engine will run rough. Remember that the engine is capable of completely shutting down automatically to prevent engine damage, therefore:

1. Pull off the road as soon as safely possible and turn off the engine.
2. Arrange for the vehicle to be taken to a service facility.
3. If this is not possible, wait a short period for the engine to cool.
4. Check the coolant level and replenish if low.



Never remove the coolant reservoir cap while the engine is running or hot.

5. Re-start the engine and take your vehicle to a service facility.

## Maintenance and Specifications

**Driving the vehicle without repairing the engine problem increases the chance of engine damage. Take your vehicle to a service facility as soon as possible.**

### WHAT YOU SHOULD KNOW ABOUT AUTOMOTIVE FUELS

#### Important safety precautions



Do not overfill the fuel tank. The pressure in an overfilled tank may cause leakage and lead to fuel spray and fire.



The fuel system may be under pressure. If the fuel filler cap is venting vapor or if you hear a hissing sound, wait until it stops before completely removing the fuel filler cap. Otherwise, fuel may spray out and injure you or others.



If you do not use the proper fuel filler cap, excessive pressure or vacuum in the fuel tank may damage the fuel system or cause the fuel cap to disengage in a collision, which may result in possible personal injury.



Automotive fuels can cause serious injury or death if misused or mishandled.



Gasoline may contain benzene, which is a cancer-causing agent.

Observe the following guidelines when handling automotive fuel:

- Extinguish all smoking materials and any open flames before fueling your vehicle.
- Always turn off the vehicle before fueling.
- Automotive fuels can be harmful or fatal if swallowed. Fuel such as gasoline is highly toxic and if swallowed can cause death or permanent injury. If fuel is swallowed, call a physician immediately, even if no symptoms are immediately apparent. The toxic effects of fuel may not be visible for hours.



## Maintenance and Specifications

- Avoid inhaling fuel vapors. Inhaling too much fuel vapor of any kind can lead to eye and respiratory tract irritation. In severe cases, excessive or prolonged breathing of fuel vapor can cause serious illness and permanent injury.
- Avoid getting fuel liquid in your eyes. If fuel is splashed in the eyes, remove contact lenses (if worn), flush with water for 15 minutes and seek medical attention. Failure to seek proper medical attention could lead to permanent injury.
- Fuels can also be harmful if absorbed through the skin. If fuel is splashed on the skin and/or clothing, promptly remove contaminated clothing and wash skin thoroughly with soap and water. Repeated or prolonged skin contact with fuel liquid or vapor causes skin irritation.
- Be particularly careful if you are taking “Antabuse” or other forms of disulfiram for the treatment of alcoholism. Breathing gasoline vapors, or skin contact could cause an adverse reaction. In sensitive individuals, serious personal injury or sickness may result. If fuel is splashed on the skin, promptly wash skin thoroughly with soap and water. Consult a physician immediately if you experience an adverse reaction.



When refueling always shut the engine off and never allow sparks or open flames near the filler neck. Never smoke while refueling. Fuel vapor is extremely hazardous under certain conditions. Care should be taken to avoid inhaling excess fumes.



The flow of fuel through a fuel pump nozzle can produce static electricity, which can cause a fire if fuel is pumped into an ungrounded fuel container.

Use the following guidelines to avoid static build-up when filling an ungrounded fuel container:

- Place approved fuel container on the ground.
- DO NOT fill a fuel container while it is in the vehicle (including the cargo area).
- Keep the fuel pump nozzle in contact with the fuel container while filling.
- DO NOT use a device that would hold the fuel pump handle in the fill position.

## Maintenance and Specifications

### Fuel Filler Cap

Your fuel tank filler cap has an indexed design with a 1/8 turn on/off feature.

When fueling your vehicle:

1. Turn the engine off.
2. Carefully turn the filler cap counterclockwise 1/8 of a turn until it stops.
3. Pull to remove the cap from the fuel filler pipe.
4. To install the cap, align the tabs on the cap with the notches on the filler pipe.
5. Turn the filler cap clockwise 1/8 of a turn until it stops.

If the “Service Engine Soon/Check Engine” indicator comes on and stays on after you start the engine, the fuel filler cap may not be properly installed. Turn off the engine, remove the fuel filler cap, align the cap properly and reinstall it.

**If you must replace the fuel filler cap, replace it with a fuel filler cap that is designed for your vehicle. The customer warranty may be void for any damage to the fuel tank or fuel system if the correct genuine Ford or Motorcraft fuel filler cap is not used.**



The fuel system may be under pressure. If the fuel filler cap is venting vapor or if you hear a hissing sound, wait until it stops before completely removing the fuel filler cap. Otherwise, fuel may spray out and injure you or others.



If you do not use the proper fuel filler cap, excessive pressure or vacuum in the fuel tank may damage the fuel system or cause the fuel cap to disengage in a collision, which may result in possible personal injury.

### Choosing the right fuel

Use only UNLEADED FUEL. The use of leaded fuel is prohibited by law and could damage your vehicle.

Do not use fuel containing methanol. It can damage critical fuel system components.

Your vehicle was not designed to use fuel or fuel additives with metallic compounds, including manganese-based compounds containing MMT.

Repairs to correct the effects of using a fuel for which your vehicle was not designed may not be covered by your warranty.

## Maintenance and Specifications

### Octane recommendations

Your vehicle is designed to use “Regular” unleaded gasoline with pump (R+M)/2 octane rating of 87. We do not recommend the use of gasolines labeled as “Regular” that are sold with octane ratings of 86 or lower in high altitude areas.

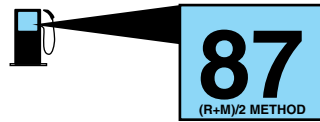

Do not be concerned if your engine sometimes knocks lightly. However, if it knocks heavily under most driving conditions while you are using fuel with the recommended octane rating, see your dealer or a qualified service technician to prevent any engine damage.

### Fuel quality

If you are experiencing starting, rough idle or hesitation driveability problems during a cold start, try a different brand of “Regular” unleaded gasoline. “Premium” unleaded gasoline is not recommended (particularly in the United States) because it may cause these problems to become more pronounced. If the problems persist, see your dealer or a qualified service technician.

It should not be necessary to add any aftermarket products to your fuel tank if you continue to use high quality fuel of the recommended octane rating. Aftermarket products could cause damage to the fuel system. Repairs to correct the effects of using an aftermarket product in your fuel may not be covered by your warranty.

Many of the world’s automakers issued the World-wide Fuel Charter that recommends gasoline specifications to provide improved performance and emission control system protection for your vehicle. Gasolines that meet the World-wide Fuel Charter should be used when available. Ask your fuel supplier about gasolines that meet the World-wide Fuel Charter. In Canada, look for fuels that display the **Auto Makers’ Choice**<sup>™</sup> logo.



### Cleaner air

Ford endorses the use of reformulated “cleaner-burning” gasolines to improve air quality.

## Maintenance and Specifications

### Running out of fuel

Avoid running out of fuel because this situation may have an adverse affect on powertrain components.

If you have run out of fuel:

- You may need to cycle the ignition from OFF to ON several times after refueling, to allow the fuel system to pump the fuel from the tank to the engine.
- Your “Service Engine Soon” indicator may come on. For more information on the “Service Engine Soon” indicator, refer to the *Instrument cluster* chapter.

### Fuel Filter

For fuel filter replacement, see your dealer or a qualified service technician. Refer to the scheduled maintenance guide for the appropriate intervals for changing the fuel filter.

**Replace the fuel filter with an authorized Motorcraft part. The customer warranty may be void for any damage to the fuel system if an authorized Motorcraft fuel filter is not used.**

## ESSENTIALS OF GOOD FUEL ECONOMY

### Measuring techniques

Your best source of information about actual fuel economy is you, the driver. You must gather information as accurately and consistently as possible. Fuel expense, frequency of fill-ups or fuel gauge readings are NOT accurate as a measure of fuel economy. We do not recommend taking fuel economy measurements during the first 1,600 km (1,000 miles) of driving (engine break-in period). You will get a more accurate measurement after 3,000 km–5,000 km (2,000 miles–3,000 miles).

### Filling the tank

The advertised fuel capacity of the fuel tank on your vehicle is equal to the rated refill capacity of the fuel tank as listed in the *Refill capacities* section of this chapter.

The advertised capacity is the amount of the indicated capacity and the empty reserve combined. Indicated capacity is the difference in the amount of fuel in a full tank and a tank when the fuel gauge indicates empty. Empty reserve is the small amount of fuel remaining in the fuel tank after the fuel gauge indicates empty.

**The amount of usable fuel in the empty reserve varies and should not be relied upon to increase driving range. When refueling your**

## Maintenance and Specifications

**vehicle after the fuel gauge indicates empty, you might not be able to refuel the full amount of the advertised capacity of the fuel tank due to the empty reserve still present in the tank.**

For consistent results when filling the fuel tank:

- Turn the engine/ignition switch to the off position prior to refueling, an error in the reading will result if the engine is left running.
- Use the same filling rate setting (low — medium — high) each time the tank is filled.
- Allow no more than 2 automatic click-offs when filling.
- Always use fuel with the recommended octane rating.
- Use a known quality gasoline, preferably a national brand.
- Use the same side of the same pump and have the vehicle facing the same direction each time you fill up.
- Have the vehicle loading and distribution the same every time.

Your results will be most accurate if your filling method is consistent.

### Calculating fuel economy

1. Fill the fuel tank completely and record the initial odometer reading (in kilometers or miles).
2. Each time you fill the tank, record the amount of fuel added (in liters or gallons).
3. After at least three to five tank fill-ups, fill the fuel tank and record the current odometer reading.
4. Subtract your initial odometer reading from the current odometer reading.
5. Follow one of the simple calculations in order to determine fuel economy:

Calculation 1: **Multiply liters used by 100, then divide by total kilometers traveled.**

Calculation 2: **Divide total miles traveled by total gallons used.**

Keep a record for at least one month and record the type of driving (city or highway). This will provide an accurate estimate of the vehicle's fuel economy under current driving conditions. Additionally, keeping records during summer and winter will show how temperature impacts fuel economy. In general, lower temperatures give lower fuel economy.

### Driving style — good driving and fuel economy habits

Give consideration to the lists that follow and you may be able to change a number of variables and improve your fuel economy.

## Maintenance and Specifications

### **Habits**

- Smooth, moderate operation can yield up to 10% savings in fuel.
- Steady speeds without stopping will usually give the best fuel economy.
- Idling for long periods of time (greater than one minute) may waste fuel.
- Anticipate stopping; slowing down may eliminate the need to stop.
- Sudden or hard accelerations may reduce fuel economy.
- Slow down gradually.
- Driving at reasonable speeds (traveling at 88 km/h [55 mph] uses 15% less fuel than traveling at 105 km/h [65 mph]).
- Revving the engine before turning it off may reduce fuel economy.
- Using the air conditioner or defroster may reduce fuel economy.
- You may want to turn off the speed control in hilly terrain if unnecessary shifting between third and fourth gear occurs. Unnecessary shifting of this type could result in reduced fuel economy.
- Warming up a vehicle on cold mornings is not required and may reduce fuel economy.
- Resting your foot on the brake pedal while driving may reduce fuel economy.
- Combine errands and minimize stop-and-go driving.

### **Maintenance**

- Keep tires properly inflated and use only recommended size.
- Operating a vehicle with the wheels out of alignment will reduce fuel economy.
- Use recommended engine oil. Refer to *Lubricant specifications* in this chapter.
- Perform all regularly scheduled maintenance items. Follow the recommended maintenance schedule and owner maintenance checks found in your vehicle scheduled maintenance guide.

### **Conditions**

- Heavily loading a vehicle or towing a trailer may reduce fuel economy at any speed.
- Carrying unnecessary weight may reduce fuel economy (approximately 0.4 km/L [1 mpg] is lost for every 180 kg [400 lb] of weight carried).



## Maintenance and Specifications

- Adding certain accessories to your vehicle (for example bug deflectors, rollbars/light bars, running boards, ski/luggage racks) may reduce fuel economy.
- Using fuel blended with alcohol may lower fuel economy.
- Fuel economy may decrease with lower temperatures during the first 12–16 km (8–10 miles) of driving.
- Driving on flat terrain offers improved fuel economy as compared to driving on hilly terrain.
- Transmissions give their best fuel economy when operated in the top cruise gear and with steady pressure on the gas pedal.
- Close windows for high speed driving.

### EPA window sticker

Every new vehicle should have the EPA window sticker. Contact your dealer if the window sticker is not supplied with your vehicle. The EPA window sticker should be your guide for the fuel economy comparisons with other vehicles.

It is important to note the box in the lower left corner of the window sticker. These numbers represent the Range of L/100 km (MPG) expected on the vehicle under optimum conditions. Your fuel economy may vary depending upon the method of operation and conditions.

### EMISSION CONTROL SYSTEM

Your vehicle is equipped with various emission control components and a catalytic converter which will enable your vehicle to comply with applicable exhaust emission standards. To make sure that the catalytic converter and other emission control components continue to work properly:

- Use only the specified fuel listed.
- Avoid running out of fuel.
- Do not turn off the ignition while your vehicle is moving, especially at high speeds.
- Have the items listed in your scheduled maintenance guide performed according to the specified schedule.

The scheduled maintenance items listed in the scheduled maintenance guide are essential to the life and performance of your vehicle and to its emissions system.

If other than Ford, Motorcraft or Ford-authorized parts are used for maintenance replacements or for service of components affecting

## Maintenance and Specifications

emission control, such non-Ford parts should be equivalent to genuine Ford Motor Company parts in performance and durability.



Do not park, idle, or drive your vehicle in dry grass or other dry ground cover. The emission system heats up the engine compartment and exhaust system, which can start a fire.

Illumination of the “Service Engine Soon” light, charging system warning light or the temperature warning light, fluid leaks, strange odors, smoke or loss of engine power, could indicate that the emission control system is not working properly.



Exhaust leaks may result in entry of harmful and potentially lethal fumes into the passenger compartment.

Do not make any unauthorized changes to your vehicle or engine. By law, vehicle owners and anyone who manufactures, repairs, services, sells, leases, trades vehicles, or supervises a fleet of vehicles are not permitted to intentionally remove an emission control device or prevent it from working. Information about your vehicle’s emission system is on the Vehicle Emission Control Information Decal located on or near the engine. This decal identifies engine displacement and gives some tune up specifications.

Please consult your *Warranty Guide* for complete emission warranty information.

### Readiness for Inspection/Maintenance (I/M) testing

In some localities, it may be a legal requirement to pass an I/M test of the on-board diagnostics system. If your “Check Engine/Service Engine Soon” light is on, refer to the description in the *Warning lights and chimes* section of the *Instrument cluster* chapter. Your vehicle may not pass the I/M test with the “Check Engine/Service Engine Soon” light on.

If the vehicle’s powertrain system or its battery has just been serviced, the on-board diagnostics system is reset to a “not ready for I/M test” condition. To ready the on-board diagnostics system for I/M testing, a minimum of 30 minutes of city and highway driving is necessary as described below:

- First, at least 10 minutes of driving on an expressway or highway.
- Next, at least 20 minutes driving in stop-and-go, city-type traffic with at least four idle periods.

Allow the vehicle to sit for at least eight hours without starting the engine. Then, start the engine and complete the above driving cycle. The

## Maintenance and Specifications

engine must warm up to its normal operating temperature. Once started, do not turn off the engine until the above driving cycle is complete.

### CHECKING AND ADDING POWER STEERING FLUID

Check the power steering fluid.  
Refer to the scheduled maintenance guide for the service interval schedules. If adding fluid is necessary, use only MERCON® ATF.

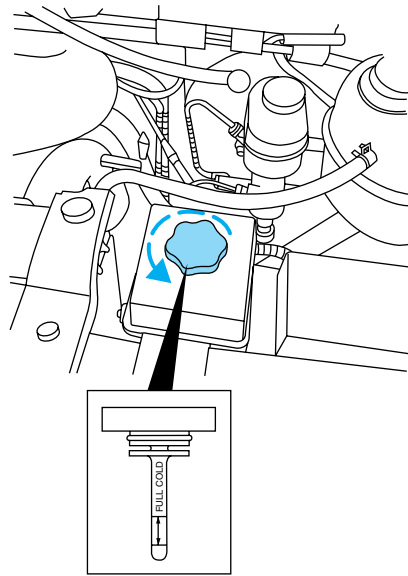

Check the fluid level when it is at ambient temperature, 20° – 80° F (-7° – 25° C):

1. Check the fluid level on the dipstick. It should be between the arrows in the FULL COLD range. Do not add fluid if the level is within this range.
2. If the fluid level is low, start the engine.
3. While the engine idles, turn the steering wheel left and right several times.
4. Turn the engine off.



For E-450 and E-550 vehicles with the Hydro-Boost Brake System, do not press the brake pedal after the engine has been turned off.

5. Recheck the fluid level on the dipstick. Do not add fluid if the level is between the arrows in the FULL COLD range.

## Maintenance and Specifications

6. If the fluid is low, add fluid in small amounts, continuously checking the level until it reaches the FULL COLD range. Be sure to put the dipstick back in the reservoir.

### **BRAKE FLUID RESERVOIR**

The fluid level will drop slowly as the brakes wear, and will rise when the brake components are replaced.

Fluid levels below the “MAX” line that do not trigger the brake system warning lamp are within the normal operating range, there is no need to add fluid. If the fluid levels are outside of the normal operating range, the performance of your brake system could be compromised, seek service from your dealer immediately.

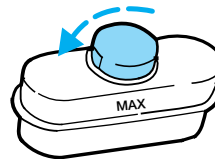

### **DRIVELINE UNIVERSAL JOINT AND SLIP YOKE**

Your vehicle may be equipped with universal joints that require lubrication. Refer to the scheduled maintenance guide for maintenance intervals. If the original universal joints are replaced with universal joints equipped with grease fittings, lubrication will also be necessary.

### **TRANSMISSION FLUID**

#### **Checking automatic transmission fluid (if equipped)**

Refer to your scheduled maintenance guide for scheduled intervals for fluid checks and changes. Your transmission does not consume fluid. However, the fluid level should be checked if the transmission is not working properly, i.e., if the transmission slips or shifts slowly or if you notice some sign of fluid leakage.

Automatic transmission fluid expands when warmed. To obtain an accurate fluid check, drive the vehicle until it is at normal operating temperature (approximately 30 km [20 miles]). If your vehicle has been operated for an extended period at high speeds, in city traffic during hot weather or pulling a trailer, the vehicle should be turned off for about 30 minutes to allow fluid to cool before checking.

1. Drive the vehicle 30 km (20 miles) or until it reaches normal operating temperature.
2. Park the vehicle on a level surface and engage the parking brake.
3. With the parking brake engaged and your foot on the brake pedal, start the engine and move the gearshift lever through all of the gear ranges. Allow sufficient time for each gear to engage.

## Maintenance and Specifications

4. Latch the gearshift lever in P (Park) and leave the engine running.
5. Remove the dipstick, wiping it clean with a clean, dry lint free rag. If necessary, refer to *Identifying components in the engine compartment* in this chapter for the location of the dipstick.
6. Install the dipstick making sure it is fully seated in the filler tube.
7. Remove the dipstick and inspect the fluid level. The fluid should be in the designated area for normal operating temperature or ambient temperature.

### Low fluid level

Do not drive the vehicle if the fluid level is at the bottom of the dipstick and the ambient temperature is above 10°C (50°F).



### Correct fluid level

The transmission fluid should be checked at normal operating temperature 66°C-77°C (150°F-170°F) on a level surface. The normal operating temperature can be reached after approximately 30 km (20 miles) of driving.

You can check the fluid without driving if the ambient temperature is above 10°C (50°F). However, if fluid is added at this time, an overfill condition could result when the vehicle reaches normal operating temperature.

The transmission fluid should be in this range if at normal operating temperature (66°C-77°C [150°F-170°F]).

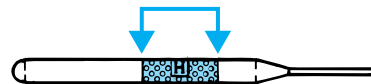

The transmission fluid should be in this range if at ambient temperature (10°C-35°C [50°F-95°F]).



### High fluid level

Fluid levels above the safe range may result in transmission failure. An overfill condition of transmission fluid may cause shift and/or engagement concerns and/or possible damage.

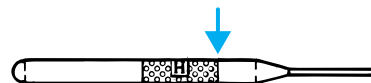

High fluid levels can be caused by an overheating condition.

## Maintenance and Specifications

### **Adjusting automatic transmission fluid levels**

Before adding any fluid, make sure the correct type is used. The type of fluid used is normally indicated on the dipstick and also in the *Lubricant specifications* section in this chapter.

### **Use of a non-approved automatic transmission fluid may cause internal transmission component damage.**

If necessary, add fluid in 250 ml (1/2 pint) increments through the filler tube until the level is correct.

If an overfill occurs, excess fluid should be removed by a qualified technician.

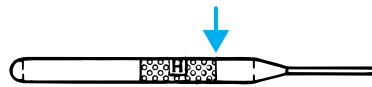

### **An overfill condition of transmission fluid may cause shift and/or engagement concerns and/or possible damage.**

Do not use supplemental transmission fluid additives, treatments or cleaning agents. The use of these materials may affect transmission operation and result in damage to internal transmission components.

### **AIR FILTER MAINTENANCE**

Refer to the scheduled maintenance guide for the appropriate intervals for changing the air filter element.

When changing the air filter element, use only the Motorcraft air filter element listed. Refer to *Motorcraft Part Numbers*.

**Note:** Do not start your engine with the air cleaner removed and do not remove it while the engine is running.

### **Changing the air filter element**

1. Disconnect the fresh air inlet tube from the radiator support.
2. Loosen the clamp that secures the two halves of the air filter housing together.

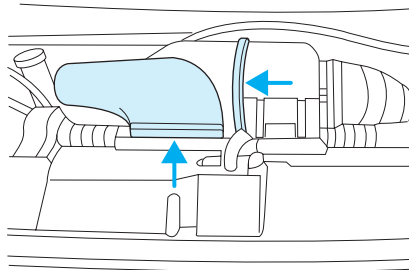

## Maintenance and Specifications

- Carefully separate the two halves of the air filter housing.
- Remove the air filter element from the housing.

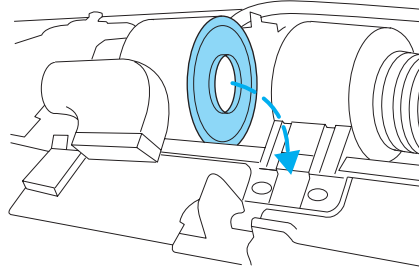

- Install a new air filter element. Be careful not to crimp the filter element edges between the air filter housing. This could cause filter damage and allow unfiltered air to enter the engine if not properly seated.
- Replace the two halves of the air filter housing and secure the clamp.
- Connect the fresh air inlet tube to the radiator support.

### INFORMATION ABOUT UNIFORM TIRE QUALITY GRADING

New vehicles are fitted with tires that have a rating on them called Tire Quality Grades. The Quality grades can be found where applicable on the tire sidewall between tread shoulder and maximum section width. For example:

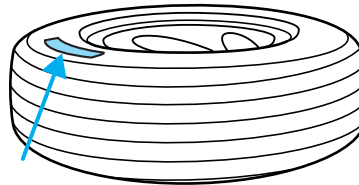

- **Treadwear 200 Traction AA Temperature A**

These Tire Quality Grades are determined by standards that the United States Department of Transportation has set.

Tire Quality Grades apply to new pneumatic tires for use on passenger cars. They do not apply to deep tread, winter-type snow tires, space-saver or temporary use spare tires, tires with nominal rim diameters of 10 to 12 inches or limited production tires as defined in Title 49 Code of Federal Regulations Part 575.104(c)(2).

**U.S. Department of Transportation-Tire quality grades:** The U.S. Department of Transportation requires Ford to give you the following information about tire grades exactly as the government has written it.

#### **Treadwear**

The treadwear grade is a comparative rating based on the wear rate of the tire when tested under controlled conditions on a specified

## Maintenance and Specifications

government test course. For example, a tire graded 150 would wear one and one-half (1 1/2) times as well on the government course as a tire graded 100. The relative performance of tires depends upon the actual conditions of their use, however, and may depart significantly from the norm due to variations in driving habits, service practices, and differences in road characteristics and climate.

### Traction AA A B C

The traction grades, from highest to lowest are AA, A, B, and C. The grades represent the tire's ability to stop on wet pavement as measured under controlled conditions on specified government test surfaces of asphalt and concrete. A tire marked C may have poor traction performance.



The traction grade assigned to this tire is based on straight-ahead braking traction tests, and does not include acceleration, cornering, hydroplaning or peak traction characteristics.

### Temperature A B C

The temperature grades are A (the highest), B and C, representing the tire's resistance to the generation of heat and its ability to dissipate heat when tested under controlled conditions on a specified indoor laboratory test wheel. Sustained high temperature can cause the material of the tire to degenerate and reduce tire life, and excessive temperature can lead to sudden tire failure. The grade C corresponds to a level of performance which all passenger car tires must meet under the Federal Motor Vehicle Safety Standard No. 109. Grades B and A represent higher levels of performance on the laboratory test wheel than the minimum required by law.



The temperature grade for this tire is established for a tire that is properly inflated and not overloaded. Excessive speed, underinflation, or excessive loading, either separately or in combination, can cause heat buildup and possible tire failure.



## Maintenance and Specifications

### SERVICING YOUR TIRES

#### Tire inflation information

The E550 vehicles are equipped with a tire that is an all-steel radial. All-steel radial tires utilize steel cords in the sidewalls, and also require increased inflation pressures of up to 95 psi. As such, they cannot be treated like normal light truck tires. Tire service, including adjusting tire pressure, must be performed by personnel trained, supervised and equipped according to Federal Occupational Safety and Health Administration (OSHA) regulations. For example, during any procedure involving tire inflation, the technician or individual must utilize a remote inflation device, and insure that all persons are clear of the trajectory area.

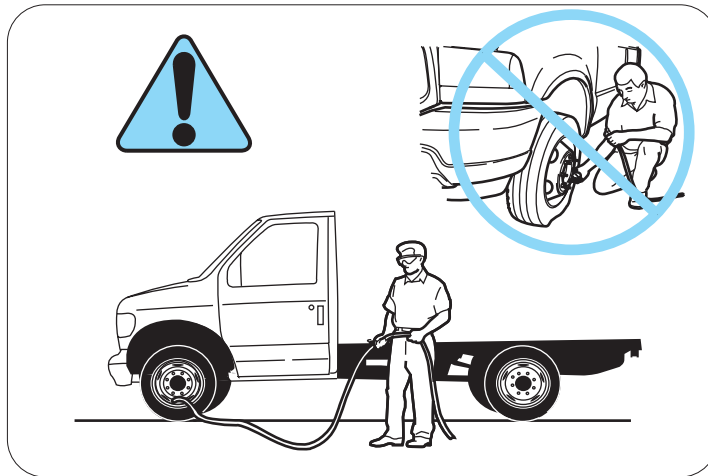

**!** **WARNING** An inflated tire and rim can be very dangerous if improperly used, serviced or maintained. To reduce the risk of serious injury, never attempt to re-inflate a tire which has been run flat or seriously under-inflated without first removing the tire from the wheel assembly for inspection. Do not attempt to add air to tires or replace tires or wheels without first taking precautions to protect persons and property.

## Maintenance and Specifications

### Tire rotation

Because your vehicle's tires perform different jobs, they often wear differently. To make sure your tires wear evenly and last longer, rotate them as indicated in the scheduled maintenance guide. If you notice that the tires wear unevenly, have them checked.

The following procedure applies to vehicles equipped with single rear wheels, if your vehicle is equipped with dual rear wheels it is recommended that only the front wheels be rotated (side to side).

- Four tire rotation

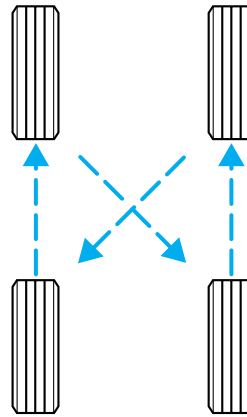

- Five tire rotation

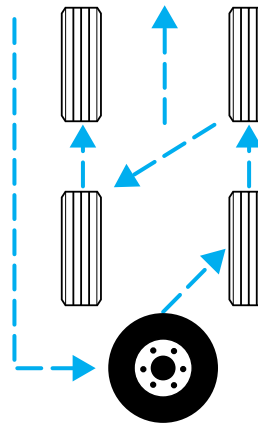



## Maintenance and Specifications

### Replacing the tires

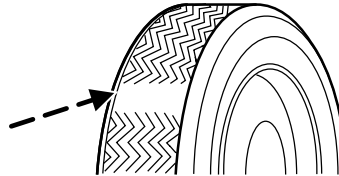
Replace the tires when the wear band is visible through the tire treads. Due to exposure to the elements and exhaust you should replace the spare tire when you replace the other tires.



 When replacing full size tires, never mix radial bias-belted, or bias-type tires. Use only the tire sizes that are listed on the Certification Label. Make sure that all tires are the same size, speed rating, and load-carrying capacity. Use only the tire combinations recommended on the label. If you do not follow these precautions, your vehicle handling may be affected which can lead to loss of vehicle control, vehicle rollover and/or personal injury.

 Make sure that all replacement tires are of the same size, type, speed rating, load-carrying capacity and tread design (e.g., “All Terrain”, “Touring”, etc.), as originally offered by Ford.

 Do not replace your tires with “high performance” tires or larger size tires.

 Failure to follow these precautions may adversely affect the handling of the vehicle, and increase the risk of loss of vehicle control, vehicle rollover and/or personal injury.

Tires that are larger or smaller than your vehicle’s original tires may also affect the accuracy of your speedometer.

### SNOW TIRES AND CHAINS

 Snow tires must be the same size and grade as the tires you currently have on your vehicle.

The tires on your vehicle have all weather treads to provide traction in rain and snow. However, in some climates, you may need to use snow

## Maintenance and Specifications

tires and chains. If you need to use chains, it is recommended that steel wheels (of the same size and specifications) be used, as chains may chip aluminum wheels.

Follow these guidelines when using snow tires and chains:

- Use only SAE Class S chains.
- Install chains securely, verifying that the chains do not touch any wiring, brake lines or fuel lines.
- Drive cautiously. If you hear the chains rub or bang against your vehicle, stop and re-tighten the chains. If this does not work, remove the chains to prevent damage to your vehicle.
- If possible, avoid fully loading your vehicle.
- Remove the tire chains when they are no longer needed. Do not use tire chains on dry roads.
- The suspension insulation and bumpers will help prevent vehicle damage. Do not remove these components from your vehicle when using snow tires and chains.

### MOTORCRAFT PART NUMBERS

Component <sup>1</sup>	4.2L V6 engine	4.6L V8 engine	5.4L V8 engine	6.8L V10 engine
Air filter element	FA-1634	FA-1634	FA-1634	FA-1634
Battery (standard)	BXT-65-750	BXT-65-750	BXT-65-750	BXT-65-750
Battery (auxiliary)	BH-65DC	BH-65DC	BH-65DC	BH-65DC
Fuel filter	FG-872	FG-872	FG-872	FG-872
Oil filter	FL-400-S	FL-820-S	FL-820-S	FL-820-S
PCV valve	EV-251	EV-233	EV-233	EV-233
Spark plugs <sup>2</sup>	AGSF-34EEM <sup>3</sup>	AWSF-32PP <sup>4</sup>	AGSF-22W	AGSF-22W

<sup>1</sup>Refer to the *7.3 Liter Power Stroke Direct Injection Turbo Diesel Owner's Guide Supplement* for Motorcraft diesel engine service part numbers.

<sup>2</sup>Refer to Vehicle Emissions Control Information (VECI) decal for spark plug gap information.

## Maintenance and Specifications

<sup>3</sup>If a spark plug is removed for inspection, it must be reinstalled in the same cylinder. Cylinders No. 1, 2 and 3 have a “EGM” suffix. Cylinders No. 4, 5 and 6 have a “EM” suffix. If a spark plug needs to be replaced, use only spark plugs with the service part number suffix letter “EEM” as shown on the engine decal.

<sup>4</sup> If a spark plug is removed for inspection, it must be reinstalled in the same cylinder. Cylinders No. 1, 2, 3 and 4 have a “PG” suffix. Cylinders No. 5, 6, 7 and 8 have a “P” suffix. If a spark plug needs to be replaced, use only spark plugs with the service part number suffix letter as shown on the engine decal.

### REFILL CAPACITIES

Fluid	Ford Part Name	Application	Capacity
Brake fluid	Motorcraft High Performance DOT 3 Motor Vehicle Brake Fluid	All	Fill to line on reservoir
Engine oil-gasoline engine (includes filter change)	Motorcraft SAE 5W-20 Premium Synthetic Blend Motor Oil	All	5.7L (6.0 quarts)
Engine oil-diesel engine (includes filter change)	Refer to the <i>7.3L Power Stroke Direct Injection Turbo Diesel Owner's Guide Supplement</i> .		

## Maintenance and Specifications

Fluid	Ford Part Name	Application	Capacity
Engine coolant-gasoline engine <sup>1</sup>	Motorcraft Premium Engine Coolant (green-colored) <b>or</b> Motorcraft Premium Gold Engine Coolant (yellow-colored)	4.2L V6 engine	22.0L (23.3 quarts)
			1 row – 20.9L (22.1 quarts) <sup>8</sup>
		4.2L V6 engine with aux rear heat	24.0L (25.4 quarts)
			1 row – 22.9L (24.2 quarts) <sup>8</sup>
		4.6L V8 engine	23.7L (25.0 quarts)
			1 row – 22.6L (23.8 quarts) <sup>8</sup>
		4.6L V8 engine with aux rear heat	25.7L (27.2 quarts)
			1 row – 24.6L (26.0 quarts) <sup>8</sup>
		5.4L V8 engine	27.4L (29.0 quarts)
			1 row – 26.3L (27.8 quarts) <sup>8</sup>
		5.4L V8 engine with aux rear heat	29.4L (31.0 quarts)
			1 row – 28.3L (29.8 quarts) <sup>8</sup>
6.8L V10 engine	29.0L (30.6 quarts)		
	1 row – 27.9L (29.4 quarts) <sup>8</sup>		
6.8L V10 engine with aux rear heat	31.0L (32.8 quarts)		
	1 row – 29.9L (31.6 quarts) <sup>8</sup>		
Engine coolant-diesel engine	Refer to the <i>7.3L Power Stroke Direct Injection Turbo Diesel Owner's Guide Supplement</i> . <sup>1</sup>		

## Maintenance and Specifications

Fluid	Ford Part Name	Application	Capacity
Power steering fluid	Motorcraft MERCON® ATF	All	Keep in FULL range on dispstick
Rear axle <sup>4</sup>	Motorcraft SAE 75W-140 Synthetic rear axle lubricant	Visteon 8.8/9.75 inch conventional and Traction-Lok	2.6-2.7L (5.5-5.8 pints) <sup>2</sup>
	Hypoid Gear Oil SAE 90	Dana 9.75 inch (M60-IU)	3.0L (6.3 pints) <sup>3</sup>
	Motorcraft 80W-90 Premium rear axle lubricant	Dana 10.5 inch (M70-2U)	3.1L (6.6 pints) <sup>3</sup>
		Dana 10.5 inch (M70-1HD)	3.5L (7.5 pints) <sup>3</sup>
		Dana 135 (E-550 only)	11.6L (24.5 pints) <sup>3</sup>
Fuel tank	N/A	All regular and extended length vans and wagons	132.4L (35.0 gallons)
		138 inch wheelbase (except E-Super Duty)	140.0L (37.0 gallons)
		158 inch wheelbase (except E-Super Duty)	140.0L (37.0 gallons) <sup>5</sup>
		176 inch wheelbase (except E-Super Duty)	140.0L (37.0 gallons)
		158 inch and 176 inch wheelbase (E-Super Duty)	208.0L (55.0 gallons)
		E-550	208.0L (55.0 gallons)

## Maintenance and Specifications

Fluid	Ford Part Name	Application	Capacity
Transmission fluid <sup>6</sup>	Motorcraft MERCON <sup>®</sup> V ATF	Automatic (4R70W)	13.2L (13.9 quarts) <sup>7</sup>
	Motorcraft MERCON <sup>®</sup> ATF	Automatic (4R100 except E-450)	16.1L (17.0 quarts) <sup>7</sup>
		Automatic (4R100 E-450 and E-550)	16.7L (17.7 quarts) <sup>7</sup>
Windshield washer fluid	Motorcraft Premium Windshield Washer Concentrate	All	4.0L (4.2 quarts)

<sup>1</sup>Add the coolant type originally equipped in your vehicle.

<sup>2</sup>If your vehicle's rear axle is filled with a synthetic rear axle lubricant it is considered lubricated for life. These lubricants do not need to be checked or changed unless a leak is suspected, service is required or the axle assembly has been submerged in water. The axle lubricant should be changed any time the rear axle has been submerged in water.

Fill 6 mm to 14 mm (1/4 inch to 9/16 inch) below bottom of fill hole. Add 118 ml (4 oz.) of Additive Friction Modifier XL-3 or equivalent meeting Ford specification EST-M2C118-A, for complete refill of 8.8 inch and 9.75 inch Traction-Lok axles.

<sup>3</sup>Fill Dana rear axles to 6 mm to 19 mm (1/4 inch to 3/4 inch) below bottom of fill hole.

<sup>4</sup>Visteon Traction-Lok axles require 118 ml (4 oz.) of Additive Friction Modifier XL-3 or equivalent meeting Ford specification EST-M2C118-A. Dana limited-slip axles (E250/350/450/550) require 237ml (8 oz.) of Additive Friction Modifier C8AZ-19B546-A or equivalent meeting Ford specification EST-M2C118-A.

<sup>5</sup>Optional fuel tank 208L (55 gallon).

<sup>6</sup>Ensure the correct automatic transmission fluid is used. Transmission fluid requirements are indicated on the dipstick or on the dipstick handle. Check the container to verify the fluid being added is of the correct type. Refer to your scheduled maintenance guide to determine the correct service interval.



## Maintenance and Specifications

Some transmission fluids may be labeled as dual usage, such as MERCON® and MERCON® V. These dual usage fluids are not to be used in an automatic transmission that requires use of the MERCON® type fluid. However, these dual usage fluids may be used in transmissions that require the MERCON® V type fluid.

**MERCON® and MERCON® V type fluids are not interchangeable. DO NOT mix MERCON® and MERCON® V. Use of a transmission fluid that indicates dual usage (MERCON® and MERCON® V) in an automatic transmission application requiring MERCON® may cause transmission damage. Use of any fluid other than the recommended fluid may cause transmission damage.**

<sup>7</sup>Approximate dry fill capacity including transmission fluid cooling system, actual refill capacities will vary based on vehicle application and transmission fluid cooling system (i.e. coolers size, cooling lines, auxiliary cooler capacities). The amount of transmission fluid and fluid level should be set by the indication on the dipstick's normal operating range.

<sup>8</sup>If your vehicle is equipped with a single row radiator, there will be a label on the top side of the radiator indicating "1 Row Radiator".

### LUBRICANT SPECIFICATIONS

Item	Ford part name	Ford part number	Ford specification
Brake fluid	Motorcraft High Performance DOT 3 Motor Vehicle Brake Fluid	PM-1	ESA-M6C25-A and DOT 3
Door weatherstrips	Silicone Lubricant	F5AZ-19553-AA	ESR-M13P4-A
Engine coolant	Motorcraft Premium Engine Coolant (green-colored)	VC-4-A (in Canada, Motorcraft CXC-10)	ESE-M97B44-A
	Motorcraft Premium Gold Engine Coolant (yellow-colored)	VC-7-A	WSS -M97B51-A1

## Maintenance and Specifications

Item	Ford part name	Ford part number	Ford specification
Engine oil-gasoline engine	Motorcraft SAE 5W-20 Premium Synthetic Blend Motor Oil	XO-5W20-QSP	WSS-M2C153-H with API Certification Mark
Engine oil-diesel engine	Refer to the <i>7.3 Liter Power Stroke Direct Injection Turbo Diesel Owner's Guide Supplement</i> .		
Hinges, latches, Striker plates, fuel filler door hinge, and seat tracks	Motorcraft Multi-Purpose Grease	XG-4 or XL-5	ESR-M1C159-A or ESB-M1C93-B
Lock cylinders	Motorcraft Penetrating and Lock Lubricant	Motorcraft XL-1	none
Power steering fluid	Motorcraft MERCON® ATF	XT-2-QDX	MERCON®
Automatic transmission (4R100) <sup>1</sup>	Motorcraft MERCON® ATF	XT-2-QDX	MERCON®
Automatic transmission (4R70W) <sup>1</sup>	Motorcraft MERCON®V ATF	XT-5-QM	MERCON®V
Disc brake caliper rails	Motorcraft Silicone Brake Caliper Grease and Dielectric Compound	XG-4	ESE-M1C171-A
Parking brake assembly (E-450/550 Super Duty)	Motorcraft MERCON® Automatic Transmission Fluid	XT-2-QDX	MERCON®
Visteon conventional and Traction-Lok axles (E-150) <sup>2</sup>	Motorcraft SAE 75W-140 High Performance Synthetic Rear Axle Lubricant	XY-75W140-QL	WSL-M2C192-A

## Maintenance and Specifications

Item	Ford part name	Ford part number	Ford specification
Dana 9.75 inch (M60-1U) <sup>3</sup>	Hypoid Gear Oil SAE 90	C6AZ-19580-E	ESW-M2C105-E
10.5 inch (M70-2U) (M70-1HD) (E-250/350/450/550) <sup>3</sup>	Motorcraft SAE 80W-90 Premium Rear Axle Lubricant	XY-80W90-QL	WSP-M2C197-A
Windshield washer fluid	Motorcraft Premium Windshield Washer Concentrate	ZC-32-A	WSB-M8B16-A2

<sup>1</sup>Ensure the correct automatic transmission fluid is used. Transmission fluid requirements are indicated on the dipstick or on the dipstick handle. Check the container to verify the fluid being added is of the correct type. Refer to your scheduled maintenance guide to determine the correct service interval.

Some transmission fluids may be labeled as dual usage, such as MERCON® and MERCON® V. These dual usage fluids are not to be used in an automatic transmission that requires use of the MERCON® type fluid. However, these dual usage fluids may be used in transmissions that require the MERCON® V type fluid.

**MERCON® and MERCON® V type fluids are not interchangeable. DO NOT mix MERCON® and MERCON® V. Use of a transmission fluid that indicates dual usage (MERCON® and MERCON® V) in an automatic transmission application requiring MERCON® may cause transmission damage. Use of any fluid other than the recommended fluid may cause transmission damage.**

<sup>2</sup>Add 118 ml (4 oz.) of Additive Friction Modifier XL-3 or equivalent meeting Ford specification EST-M2C118-A for complete refill of Visteon Traction-Lok rear axles.

<sup>3</sup>Add 237 ml (8 oz.) of Additive Friction Modifier C8AZ-19B546-A or equivalent meeting Ford specification EST-M2C118-A for complete refill of Dana Traction-Lok rear axles.

## Maintenance and Specifications

### ENGINE DATA

Engine*	4.2L V6 engine	4.6L V8 engine	5.4L V8 engine	6.8L V10 engine
Cubic inches	256	281	330	415
Required fuel	87 octane	87 octane	87 octane	87 octane
Firing order	1-4-2-5-3-6	1-3-7-2-6-5-4-8	1-3-7-2-6-5-4-8	1-6-5-10-2-7-3-8-4-9
Spark plug gap	1.3-1.4 mm (0.052-0.056 inch)	1.3-1.4 mm (0.052-0.056 inch)	1.3-1.4 mm (0.052-0.056 inch)	1.3-1.4 mm (0.052-0.056 inch)
Ignition system	EDIS	Coil on plug	Coil on plug	Coil on plug
Compression ratio	9.3:1	9.4:1	9.0:1	9.0:1

\*Refer to the *7.3 Liter Power Stroke Direct Injection Turbo Diesel Owner's Guide Supplement* for diesel engine information.

### VEHICLE DIMENSIONS

#### Van/wagon models

	E-150	E-250	E-350
(1) Overall height	2050 mm (80.7 in)	2118 mm (83.4 in)	2136 mm (84.1 in)
(2) Track front/rear	1763 mm (69.4 in)/ 1 702 mm (67.0 in)		
(3) Overall width (excluding mirrors)	2014 mm (79.3 in)		
(4) Wheelbase	3505 mm (138 in)		
(5) Overall length	Regular van, 5382 mm (211.9 in) Extended, 5890 mm (231.9 in)		

Maintenance and Specifications

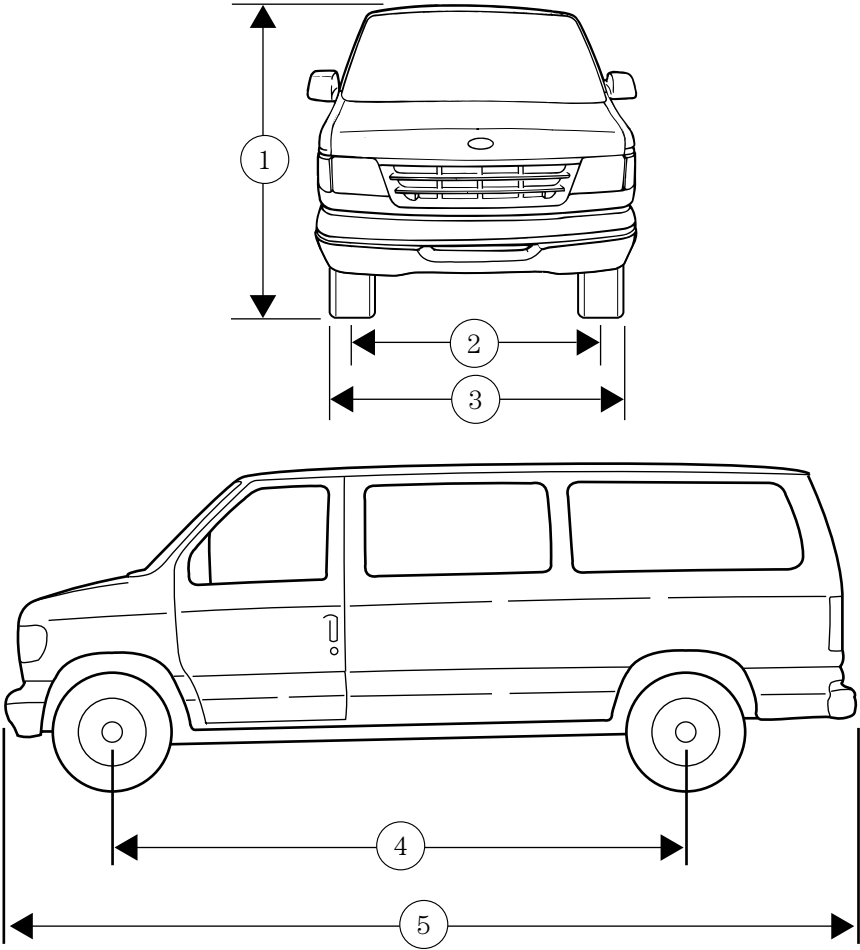

## Maintenance and Specifications

### Cutaway/commercial stripped chassis models

Dimension	Body style			
	E-250	E-350	E-450 Super Duty	E-550 Super Duty
(1) Overall height	Refer to Body Builder for specifications.			
(2) Track (Front / Rear)	1 763 mm (69.4 in)/ 1 689 mm (66.5 in)	1 763 mm (69.4 in)/ SRW 1689 mm (66.5 in), DRW 1 859 mm (73.2 in)	1 763 mm (69.4 in)/ 1 973 mm (77.7 in)	1 999 mm (78.7 in)/ 1 970 mm (77.5 in)
(3) Overall width	Refer to Body Builder for specifications.			
(4) Wheelbase	3 149.6 mm (124 in)	3 505 mm (138 in) 4 013 mm (158 in) 4 470 mm (176 in)	4 013 mm (158 in) 4 470 mm (176 in)	4 051 mm (159.5 in) 4 508 mm (177.5 in) 4 864 mm (191.5 in) 5 321 mm (209.5 in) 5 930 mm (233.5 in)
(5) Overall length	Refer to Body Builder for specifications.			

### VEHICLE IDENTIFICATION NUMBER

#### Complete Ford built vehicles

The vehicle identification number is attached to your vehicle in the following places:

- On the metal tag attached to the top of the instrument panel on the driver's side.

## Maintenance and Specifications

- On the certification label. This label is required by the National Highway Traffic Safety Administration and is made of special material. If it is tampered with, it will be destroyed or a destruction pattern will appear.

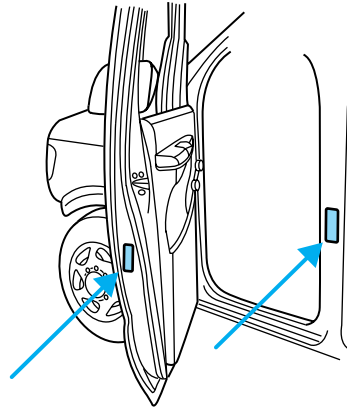

### **Certification label for incomplete vehicles**

On completed derivations of incomplete vehicles, the certification label is affixed at a location determined by a subsequent stage manufacturer of the completed vehicle. In these cases the completed vehicle is manufactured in two or more stages by two or more separate manufacturers.

## Accessories

### FORD ACCESSORIES FOR YOUR VEHICLE

A wide selection of genuine Ford accessories are available for your vehicle through your local authorized Ford, Lincoln, Mercury or Ford of Canada dealer. These quality accessories have been specifically engineered to fulfill your automotive needs; they are custom designed to complement the style and aerodynamic appearance of your vehicle. In addition, each accessory is made from high quality materials and meets or exceeds Ford's rigorous engineering and safety specifications. Ford Motor Company will repair or replace any properly dealer-installed Ford accessory found to be defective in factory-supplied materials or workmanship during the warranty period, as well as any component damaged by the defective accessory. The accessory will be warranted for whichever provides you the greatest benefit:

- 12 months or 20,000 km (12,000 miles) (whichever occurs first), or
- the remainder of your new vehicle limited warranty.

This means that genuine Ford accessories purchased along with your new vehicle and installed by the dealer are covered for the full length of your New Vehicle's Limited Warranty — 3 years or 60,000 km (36,000 miles) (whichever occurs first). Contact your dealer for details and a copy of the warranty.

**Not all accessories are available for all models.**

#### Vehicle Security

Styled wheel locks

Vehicle security systems

#### Comfort and convenience

Engine block heaters

Remote start

Tire step



## Accessories

### **Travel equipment**

Auto head lamps with DRL  
Bicycle rack  
Cell phone holder  
Console (Engine cover)  
Daytime running lights (DRL)  
First aid and highway kits  
Fog lights  
Hitch mount bicycle carrier  
Inside mirror, electrochromic with compass (with and without temperature display)  
Removable roof rack  
Running boards — Aluminum and Platinum elliptical  
Speed control  
Tailgate table  
TracRac  
Trailer hitch (Class III)  
Trailer hitch bars and balls  
Trailer hitch wiring adaptor

### **Protection and appearance equipment**

Air bag anti-theft locks  
Battery warmer  
Carpet floor mats  
Cleaners, waxes and polishes  
Door edge guards  
Flat splash guards  
Front end covers (full)  
Hood deflector  
Rear step bumpers  
Side window air deflectors  
For maximum vehicle performance, keep the following information in mind when adding accessories or equipment to your vehicle:

## Accessories

- When adding accessories, equipment, passengers and luggage to your vehicle, do not exceed the total weight capacity of the vehicle or of the front or rear axle (GVWR or GAWR as indicated on the Safety compliance certification label). Consult your dealer for specific weight information.
- The Federal Communications Commission (FCC) and Canadian Radio Telecommunications Commission (CRTC) regulate the use of mobile communications systems - such as two-way radios, telephones and theft alarms - that are equipped with radio transmitters. Any such equipment installed in your vehicle should comply with FCC or CRTC regulations and should be installed only by a qualified service technician.
- Mobile communications systems may harm the operation of your vehicle, particularly if they are not properly designed for automotive use or are not properly installed. When operated, such systems may cause the engine to stumble or stall or cause the transmission to be damaged or operate improperly. In addition, such systems may be damaged or their performance may be affected by operating your vehicle. (Citizens band [CB] transceivers, garage door openers and other transmitters with outputs of five watts or less will not ordinarily affect your vehicle's operation.)
- Ford cannot assume responsibility for any adverse effects or damage that may result from the use of such equipment.

**A**

Air bag supplemental restraint system .....91  
 and child safety seats .....93  
 description .....91  
 disposal .....95  
 driver air bag .....93  
 indicator light .....95  
 operation .....93  
 passenger air bag .....93  
 Air cleaner filter .....206, 212  
 Ambulance packages .....6  
 Antifreeze (see Engine coolant) .....187  
 Anti-lock brake system (see Brakes) .....114–115  
 Audio system (see Radio) .....15, 17, 20, 24  
 Automatic transmission  
 driving an automatic  
 overdrive .....118  
 fluid, adding .....204  
 fluid, checking .....204  
 fluid, refill capacities .....213  
 fluid, specification .....220  
 Auxiliary power point .....65  
 Axle  
 lubricant specifications ..217, 220  
 refill capacities .....213  
 traction lok .....116

**B**

Battery .....182  
 acid, treating emergencies .....182  
 disconnecting .....184  
 jumping a disabled battery ....155  
 maintenance-free .....182  
 replacement, specifications ..212

servicing .....182  
 BeltMinder .....86  
 Brakes .....114  
 anti-lock .....114–115  
 anti-lock brake system (ABS)  
 warning light .....114  
 fluid, checking and adding ....204  
 fluid, refill capacities .....213  
 fluid, specifications .....217, 220  
 lubricant specifications ..217, 220  
 parking .....115  
 shift interlock .....117  
 Break-in period .....5  
 Bulbs .....55

**C**

Calculating load .....124  
 Capacities for refilling fluids ....213  
 Cassette tape player .....24  
 CD-single premium .....15, 17, 20  
 Cell phone use .....65  
 Child safety restraints .....96  
 child safety belts .....96  
 Child safety seats .....99  
 in front seat .....101  
 in rear seat .....101  
 tether anchorage hardware ...103  
 Cleaning your vehicle  
 engine compartment .....171  
 exterior .....174  
 instrument panel .....173  
 interior .....173  
 interior trim .....173  
 plastic parts .....172  
 washing .....170  
 waxing .....170  
 wheels .....171

## Index

- wiper blades .....172
- Climate control (see Air conditioning or Heating) .....50, 52
- Compass, electronic .....63
  - calibration .....64
  - set zone adjustment .....64
- Console
  - overhead .....62
- Controls
  - power seat .....76
- Coolant
  - checking and adding .....187
  - refill capacities .....191, 213
  - specifications .....217, 220
- Cruise control (see Speed control) .....67
- Customer Assistance .....137
  - Ford accessories for your vehicle .....174
  - Ford Extended Service Plan .....163
  - Getting assistance outside the U.S. and Canada .....167
  - Getting roadside assistance ...137
  - Getting the service you need .....161
  - Ordering additional owner's literature .....168
  - The Dispute Settlement Board .....164
  - Utilizing the Mediation/Arbitration Program .....166
- D**
- Daytime running lamps (see Lamps) .....53
- Dipstick
  - automatic transmission fluid .....204
  - engine oil .....179
- Doors
  - lubricant specifications .....217
- Driveline universal joint and slip yoke .....204
- Driving under special conditions .....121
  - through water .....121
- E**
- Emergencies, roadside
  - jump-starting .....155
- Emission control system .....201
- Engine .....220
  - cleaning .....171
  - coolant .....187
  - diesel .....6
  - fail-safe coolant .....192
  - idle speed control .....182
  - lubrication specifications .....217, 220
  - refill capacities .....213
  - service points .....177
  - starting after a collision .....139
- Engine block heater .....114
- Engine oil .....179
  - checking and adding .....179
  - dipstick .....179
  - filter, specifications .....181, 212
  - recommendations .....181
  - refill capacities .....213
  - specifications .....217, 220
- Exhaust fumes .....114
- F**
- Fail safe cooling .....192

## Index

- Fluid capacities .....213
- Four-Wheel Drive vehicles  
preparing to drive your  
vehicle .....116
- Fuel .....194  
calculating fuel economy .....198  
cap .....196  
capacity .....213  
choosing the right fuel .....196  
comparisons with EPA fuel  
economy estimates .....201  
detergent in fuel .....197  
filling your vehicle with  
fuel .....194, 196, 198  
filter, specifications .....198, 212  
fuel pump shut-off switch .....139  
improving fuel economy .....198  
octane rating .....197, 220  
quality .....197  
running out of fuel .....198  
safety information relating to  
automotive fuels .....194
- Fuses .....140–141
- G**
- Garage door opener .....63
- Gas cap (see Fuel cap) .....196
- Gas mileage (see Fuel  
economy) .....198
- Gauges .....13
- GAWR (Gross Axle Weight  
Rating) .....122  
calculating .....124  
definition .....122  
driving with a heavy load .....122  
location .....122
- GVWR (Gross Vehicle Weight  
Rating) .....122  
calculating .....122, 124
- definition .....122  
driving with a heavy load .....122  
location .....122
- H**
- Headlamps .....53  
aiming .....54  
bulb specifications .....55  
daytime running lights .....53  
flash to pass .....54  
high beam .....53  
replacing bulbs .....56–57  
turning on and off .....53
- Heating  
heater only system .....50, 52  
heating and air conditioning  
system .....51
- Hood .....177
- I**
- Ignition .....111, 220
- Infant seats (see Safety seats) ..99
- Inspection/maintenance (I/M)  
testing .....202
- Instrument panel  
clearing .....173  
cluster .....10  
lighting up panel and  
interior .....54
- J**
- Jump-starting your vehicle .....155
- K**
- Keys  
positions of the ignition .....111

## Index

### L

- Lamps
  - bulb replacement specifications chart .....55
  - cargo lamps .....54
  - daytime running light .....53
  - headlamps .....53
  - headlamps, flash to pass .....54
  - instrument panel, dimming .....54
  - interior lamps .....55
  - replacing bulbs .....55–60
- Lane change indicator (see Turn signal) .....54
- Lights, warning and indicator ....10
  - anti-lock brakes (ABS) .....114
  - speed control .....69
- Load limits .....122
  - GAWR .....122
  - GVWR .....122
  - trailer towing .....122
- Loading instructions .....124
- Lubricant specifications ...217, 220
- Lumbar support, seats .....76

### M

- Mirrors
  - fold away .....67
  - side view mirrors (power) .....66
- Motorcraft parts .....198, 212

### O

- Octane rating .....197
- Oil (see Engine oil) .....179

### P

- Parking brake .....115

- Parts (see Motorcraft parts) ....212
- Power distribution box (see Fuses) .....144
- Power door locks .....71
- Power point .....65
- Power steering .....115
  - fluid, checking and adding ....203
  - fluid, refill capacity .....213
  - fluid, specifications .....217, 220
- Power Windows .....66
- Preparing to drive your vehicle .....116

### R

- Radio .....15, 17, 20, 24
- Relays .....140, 147
- Remote entry system
  - illuminated entry .....74
  - locking/unlocking doors .....71
- Roadside assistance .....137

### S

- Safety belts (see Safety restraints) .....80, 82–85
- Safety defects, reporting .....169
- Safety restraints .....80, 82–85
  - belt minder .....86
  - cleaning the safety belts .....90
  - extension assembly .....90
  - for adults .....82–84
  - for children .....95–96
  - lap belt .....85
  - warning light and chime .....86
- Safety seats for children .....99
- Seat belts (see Safety restraints) .....80

## Index

- Seats .....75  
  child safety seats .....99
- Servicing your vehicle .....176
- Spare tire (see Changing the  
Tire) .....147
- Spark plugs,  
specifications .....212, 220
- Special notice  
  ambulance conversions .....6  
  diesel-powered vehicles .....6  
  utility-type vehicles .....6
- Specification chart,  
lubricants .....217, 220
- Speed control .....67
- Starting your vehicle .....111–113  
  jump starting .....155
- Steering wheel  
  tilting .....62
- T**
- Temperature control  
(see Climate control) .....50, 52
- Tires .....207–209  
  changing .....147–148  
  replacing .....150, 211  
  rotating .....210  
  snow tires and chains .....211  
  tire grades .....208  
  treadwear .....207
- Towing .....124  
  recreational towing .....136
- trailer towing .....124  
  wrecker .....160
- Traction-lok rear axle .....116
- Transmission .....117  
  fluid, checking and adding  
  (automatic) .....204  
  fluid, refill capacities .....213  
  lubricant specifications ..217, 220
- Trunk .....70
- Turn signal .....54
- V**
- Vehicle dimensions .....220
- Vehicle Identification Number  
(VIN) .....222
- Vehicle loading .....122
- Ventilating your vehicle .....114
- W**
- Warning lights (see Lights) .....10
- Washer fluid .....178
- Water, Driving through .....121
- Windows  
  power .....66
- Windshield washer fluid and  
wipers .....61  
  checking and adding fluid .....178  
  replacing wiper blades .....61
- Wrecker towing .....160

