

## Table of Contents

<b>Introduction</b>	<b>4</b>
<b>Instrument Cluster</b>	<b>10</b>
Warning and control lights	10
Gauges	14
<b>Entertainment Systems</b>	<b>16</b>
AM/FM stereo cassette with CD	16
AM/FM stereo with in-dash six CD	21
Rear seat controls	25
Rear seat entertainment system	30
Navigation system	43
<b>Climate Controls</b>	<b>108</b>
Rear passenger climate control	111
Rear window defroster	112
<b>Lights</b>	<b>113</b>
Headlamps	113
Turn signal control	116
Bulb replacement	117
<b>Driver Controls</b>	<b>126</b>
Windshield wiper/washer control	126
Power windows	134
Mirrors	137
Speed control	141
Message center	151
<b>Locks and Security</b>	<b>168</b>
Keys	168
Locks	168
Anti-theft system	169

## Table of Contents

<b>Seating and Safety Restraints</b>	<b>184</b>
Seating	184
Safety restraints	198
Air bags	210
Child restraints	218
<b>Driving</b>	<b>231</b>
Starting	231
Brakes	235
Air suspension	239
Transmission operation	244
Vehicle loading	264
Trailer towing	269
Recreational towing	276
<b>Roadside Emergencies</b>	<b>277</b>
Getting roadside assistance	277
Hazard flasher switch	278
Fuel pump shut-off switch	278
Fuses and relays	279
Changing tires	288
Jump starting	296
Wrecker towing	301
<b>Customer Assistance</b>	<b>303</b>
Reporting safety defects (U.S. only)	311
<b>Cleaning</b>	<b>312</b>

## Table of Contents

<b>Maintenance and Specifications</b>	<b>318</b>
Engine compartment	320
Engine oil	321
Battery	324
Fuel information	332
Air filter(s)	345
Tire Information	348
Part numbers	362
Refill capacities	363
Lubricant specifications	366
<b>Accessories</b>	<b>374</b>
<b>Index</b>	<b>376</b>

All rights reserved. Reproduction by any means, electronic or mechanical including photocopying, recording or by any information storage and retrieval system or translation in whole or part is not permitted without written authorization from Ford Motor Company. Ford may change the contents without notice and without incurring obligation.

Copyright © 2004 Ford Motor Company

## Introduction

### CALIFORNIA Proposition 65 Warning



**WARNING:** Engine exhaust, some of its constituents, and certain vehicle components contain or emit chemicals known to the State of California to cause cancer and birth defects or other reproductive harm. In addition, certain fluids contained in vehicles and certain products of component wear contain or emit chemicals known to the State of California to cause cancer and birth defects or other reproductive harm.

### CONGRATULATIONS

Congratulations on acquiring your new Lincoln. Please take the time to get well acquainted with your vehicle by reading this handbook. The more you know and understand about your vehicle, the greater the safety and pleasure you will derive from driving it.

For more information on Ford Motor Company and its products visit the following website:

- In the United States: [www.ford.com](http://www.ford.com)
- In Canada: [www.ford.ca](http://www.ford.ca)
- In Mexico: [www.ford.com.mx](http://www.ford.com.mx)
- In Australia: [www.ford.com.au](http://www.ford.com.au)

Additional owner information is given in separate publications.

This *Owner's Guide* describes every option and model variant available and therefore some of the items covered may not apply to your particular vehicle. Furthermore, due to printing cycles it may describe options before they are generally available.

Remember to pass on the *Owner's Guide* when reselling the vehicle. It is an integral part of the vehicle.



**Fuel pump shut-off switch:** In the event of an accident the safety switch will automatically cut off the fuel supply to the engine. The switch can also be activated through sudden vibration (e.g. collision when parking). To reset the switch, refer to the *Fuel pump shut-off switch* in the *Roadside Emergencies* chapter.

## Introduction

### SAFETY AND ENVIRONMENT PROTECTION

#### **Warning symbols in this guide**

How can you reduce the risk of personal injury and prevent possible damage to others, your vehicle and its equipment? In this guide, answers to such questions are contained in comments highlighted by the warning triangle symbol. These comments should be read and observed.

#### **Warning symbols on your vehicle**

When you see this symbol, it is imperative that you consult the relevant section of this guide before touching or attempting adjustment of any kind.



#### **Protecting the environment**

We must all play our part in protecting the environment. Correct vehicle usage and the authorized disposal of waste, cleaning and lubrication materials are significant steps towards this aim. Information in this respect is highlighted in this guide with the tree symbol.



### BREAKING-IN YOUR VEHICLE

Your vehicle does not need an extensive break-in. Try not to drive continuously at the same speed for the first 1,000 miles (1,600 km) of new vehicle operation. Vary your speed to allow parts to adjust themselves to other parts.

Drive your new vehicle at least 500 miles (800 km) before towing a trailer. Additionally, during the first 500 miles (800 km) that you tow a trailer, do not drive over 50 mph (80 km/h) and do not make starts at full throttle. This style of driving will help the engine and other parts of your vehicle wear-in at the heavier loads.

Do not add friction modifier compounds or special break-in oils during the first few thousand miles (kilometers) of operation, since these additives may prevent piston ring seating. See *Engine oil* in the *Maintenance and Specifications* chapter for more information on oil usage.

## Introduction

### SPECIAL NOTICES

#### Emission warranty

The New Vehicle Limited Warranty includes Bumper-to-Bumper Coverage, Safety Restraint Coverage, Corrosion Coverage, and 6.0L Power Stroke Diesel Engine Coverage. In addition, your vehicle is eligible for Emissions Defect and Emissions Performance Warranties. For a detailed description of what is covered and what is not covered, refer to the *Warranty Guide* that is provided to you along with your Owner's Guide.

#### Service Data Recording

Service data recorders in your vehicle are capable of collecting and storing diagnostic information about your vehicle. This potentially includes information about the performance or status of various systems and modules in the vehicle, such as engine, throttle, steering or brake systems. In order to properly diagnose and service your vehicle, Ford Motor Company, Ford of Canada, and service and repair facilities may access vehicle diagnostic information through a direct connection to your vehicle when diagnosing or servicing your vehicle.

#### Event Data Recording

Other modules in your vehicle — event data recorders — are capable of collecting and storing data during a crash or near crash event. The recorded information may assist in the investigation of such an event. The modules may record information about both the vehicle and the occupants, potentially including information such as:

- how various systems in your vehicle were operating;
- whether or not the driver and passenger seatbelts were buckled;
- how far (if at all) the driver was depressing the accelerator and/or the brake pedal;
- how fast the vehicle was traveling; and
- where the driver was positioning the steering wheel.

To access this information, special equipment must be directly connected to the recording modules. Ford Motor Company and Ford of Canada do not access event data recorder information without obtaining consent, unless pursuant to court order or where required by law enforcement, other government authorities or other third parties acting with lawful authority. Other parties may seek to access the information independently of Ford Motor Company and Ford of Canada.

## Introduction

### Special instructions

For your added safety, your vehicle is fitted with sophisticated electronic controls.



Please read the section *Supplemental restraint system (SRS)* in the *Seating and Safety Restraints* chapter. Failure to follow the specific warnings and instructions could result in personal injury.



Front seat mounted rear-facing child or infant seats should **NEVER** be placed in front of an active passenger air bag.

### Using your vehicle with a snowplow

#### Do not use this vehicle for snowplowing.

Your vehicle is not equipped with a snowplowing package.

### Notice to owners of pickup trucks and utility type vehicles



Utility vehicles have a significantly higher rollover rate than other types of vehicles.

Before you drive your vehicle, please read this Owner's Guide carefully. Your vehicle is not a passenger car. As with other vehicles of this type, failure to operate this vehicle correctly may result in loss of vehicle control, vehicle rollover, personal injury or death.

Be sure to read *Driving off road* in the *Driving* chapter.

### MIDDLE EAST/NORTH AFRICA VEHICLE SPECIFIC INFORMATION

For your particular global region, your vehicle may be equipped with features and options that are different from the ones that are described in this *Owner's Guide*; therefore, a supplement has been supplied that complements this book. By referring to the pages in the provided supplement, you can properly identify those features, recommendations and specifications that are unique to your vehicle. **Refer to this Owner's Guide for all other required information and warnings.**

## Introduction

These are some of the symbols you may see on your vehicle.













### Vehicle Symbol Glossary

Safety Alert		See Owner's Guide	
Fasten Safety Belt		Air Bag-Front	
Air Bag-Side		Child Seat	
Child Seat Installation Warning		Child Seat Lower Anchor	
Child Seat Tether Anchor		Brake System	
Anti-Lock Brake System		Brake Fluid - Non-Petroleum Based	
Traction Control		AdvanceTrac <sup>™</sup>	
Master Lighting Switch		Hazard Warning Flasher	
Fog Lamps-Front		Fuse Compartment	
Fuel Pump Reset		Windshield Wash/Wipe	
Windshield Defrost/Demist		Rear Window Defrost/Demist	



## Introduction

### Vehicle Symbol Glossary

Power Windows Front/Rear		Power Window Lockout	
Child Safety Door Lock/Unlock		Interior Luggage Compartment Release Symbol	
Panic Alarm		Engine Oil	
Engine Coolant		Engine Coolant Temperature	
Do Not Open When Hot		Battery	
Avoid Smoking, Flames, or Sparks		Battery Acid	
Explosive Gas		Fan Warning	
Power Steering Fluid		Maintain Correct Fluid Level	
Emission System		Engine Air Filter	
Passenger Compartment Air Filter		Jack	
Check fuel cap		Low tire warning	

## Instrument Cluster

### WARNING LIGHTS AND CHIMES

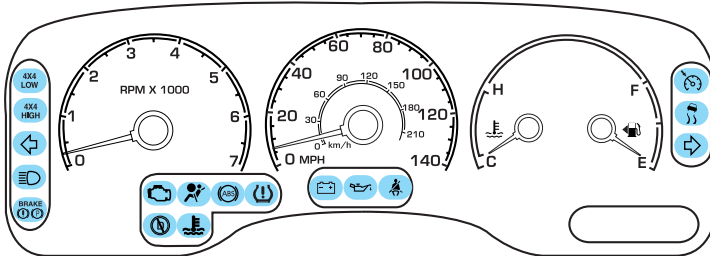

Warning lights and gauges can alert you to a vehicle condition that may become serious enough to cause expensive repairs. A warning light may illuminate when a problem exists with one of your vehicle's functions. Many lights will illuminate when you start your vehicle to make sure the bulb works. If any light remains on after starting the vehicle, have the respective system inspected immediately.

**Service engine soon:** The  indicator light illuminates when the ignition is first turned to the ON position to check the bulb. Solid illumination after the engine is started indicates the On Board Diagnostics System (OBD-II) has detected a malfunction. Refer to *On board diagnostics (OBD-II)* in the *Maintenance and Specifications* chapter. If the light is blinking, engine misfire is occurring which could damage your catalytic converter. Drive in a moderate fashion (avoid heavy acceleration and deceleration) and have your vehicle serviced immediately.

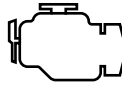

 Under engine misfire conditions, excessive exhaust temperatures could damage the catalytic converter, the fuel system, interior floor coverings or other vehicle components, possibly causing a fire.

**Brake system warning light:** To confirm the brake system warning light is functional, it will momentarily illuminate when the ignition is turned to the ON position when the engine is not running, or in a position between ON and START,



## Instrument Cluster

or by applying the parking brake when the ignition is turned to the ON position. If the brake system warning light does not illuminate at this time, seek service immediately from your dealership. Illumination after releasing the parking brake indicates low brake fluid level and the brake system should be inspected immediately by your servicing dealership.

 Driving a vehicle with the brake system warning light on is dangerous. A significant decrease in braking performance may occur. It will take you longer to stop the vehicle. Have the vehicle checked by your dealer immediately.

**Anti-lock brake system:** If the ABS light stays illuminated or continues to flash, a malfunction has been detected, have the system serviced immediately. Normal braking is still functional unless the brake warning light also is illuminated.



**Air bag readiness:** If this light fails to illuminate when ignition is turned to ON, continues to flash or remains on, have the system serviced immediately. A chime will also sound when a malfunction in the supplemental restraint system has been detected.



**Safety belt:** Reminds you to fasten your safety belt. A chime will also sound to remind you to fasten your safety belt.



**Charging system:** Illuminates when the battery is not charging properly.



**Engine oil pressure:** Illuminates when the oil pressure falls below the normal range. Refer to *Engine oil* in the *Maintenance and Specifications* chapter.



## Instrument Cluster

### Engine coolant temperature:

Illuminates when the engine coolant temperature is high. Stop the vehicle as soon as safely possible, switch off the engine and let it cool. Refer to *Engine coolant* in the *Maintenance and Specifications* chapter.



Never remove the coolant recovery cap while the engine is running or hot.

**Low tire warning:** Illuminates when the low tire warning system is enabled. If the light remains on while driving, the tire pressure should be checked, refer to *Low*

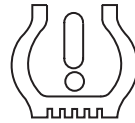

*tire warning* in the *Maintenance and Specifications* chapter. If this light fails to illuminate when ignition is turned to ON, continues to flash or remains on, have the system serviced immediately.

Warning Light display	Customer Action
Warning light remains on	<ul style="list-style-type: none"> <li>• Check your tire pressure and ensure your tires are properly inflated, refer to <i>Tire inflation pressure</i> under <i>Tires</i> in the <i>Maintenance and Specifications</i> chapter.</li> <li>• After inflating tires to the manufacturers recommended air pressure the vehicle must be driven for two minutes at 32 kp/h (20 mph) to guarantee that the light will turn off. If the light remains on, have the system inspected immediately by your servicing dealership.</li> </ul>
Warning light flashing (flashes for 20 seconds either at start up or while driving)	<ul style="list-style-type: none"> <li>• Your spare tire is in use. Repair the road wheel to restore system function.</li> <li>• If your tires are inflated to the recommended air pressure, and your spare tire is not in use, please have the system inspected immediately by your servicing dealership.</li> </ul>

## Instrument Cluster

**O/D off:** Illuminates when the overdrive function of the transmission has been turned off, refer to the *Driving* chapter. If the light flashes steadily or does not illuminate, have the transmission serviced soon, or damage may occur.



**AdvanceTrac™ (if equipped):** Illuminates when the AdvanceTrac™ system is active. If the light remains on, have the system serviced immediately.



**Speed control:** Illuminates when the speed control is activated. Turns off when the speed control system is deactivated.



**Four wheel drive low (if equipped):** Illuminates when four-wheel drive low is engaged.



**Four wheel drive high (if equipped):** Illuminates when four-wheel drive high is engaged.



**Turn signal:** Illuminates when the left or right turn signal or the hazard lights are turned on. If the indicators stay on or flash faster, check for a burned out bulb.



**High beams:** Illuminates when the high beam headlamps are turned on.



**Key-in-ignition warning chime:** Sounds when the key is left in the ignition in the OFF/LOCK or ACCESSORY position and the driver's door is opened.

**Headlamps on warning chime:** Sounds when the headlamps or parking lamps are on, the ignition is off (the key is not in the ignition) and the driver's door is opened.

**Door ajar warning chime:** Sounds when any door, liftgate or the liftgate glass is opened (or not fully closed).

## Instrument Cluster

### GAUGES

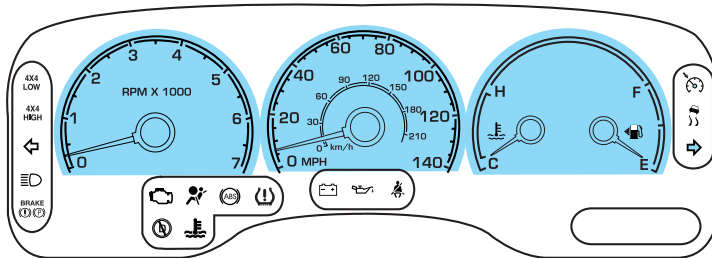

**Speedometer:** Indicates the current vehicle speed.

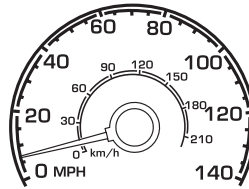

**Engine coolant temperature gauge:** Indicates engine coolant temperature. At normal operating temperature, the needle will be in the normal range (between “H” and “C”). If it enters the red section, the engine is overheating. Stop the vehicle as soon as safely possible, switch off the engine and let the engine cool. Refer to *Engine coolant* in the *Maintenance and Specifications* chapter.

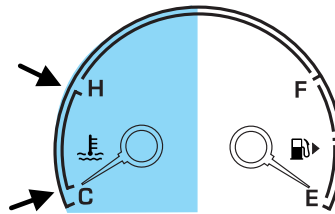

Never remove the coolant reservoir cap while the engine is running or hot.

**Odometer:** Registers the total kilometers (miles) of the vehicle.

Refer to *Message Center* in the *Drivers Controls* chapter on how to switch the display from Metric to English.

### MESSAGE CENTER



## Instrument Cluster

**Trip odometer:** Registers the kilometers (miles) of individual journeys. Press and release the message center INFO button until “TRIP” appears in the display (this represents the trip mode). Press and hold the RESET button for three seconds to reset.

MESSAGE CENTER

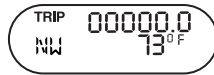

**Tachometer:** Indicates the engine speed in revolutions per minute. Driving with your tachometer pointer continuously at the top of the scale may damage the engine.

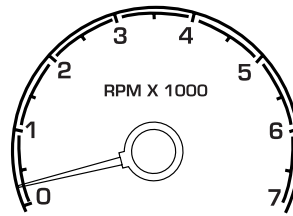

**Fuel gauge:** Indicates approximately how much fuel is left in the fuel tank (when the ignition is in the ON position). The fuel gauge may vary slightly when the vehicle is in motion or on a grade. The ignition should be in the OFF position while the vehicle is being refueled. When the gauge first indicates empty, there is a small amount of reserve fuel in the tank. When refueling the vehicle from empty indication, the amount of fuel that can be added will be less than the advertised capacity due to the reserve fuel.

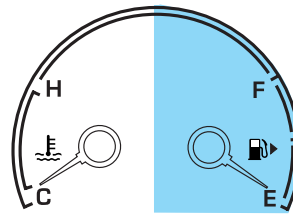

The FUEL icon and arrow indicates which side of the vehicle the fuel filler door is located.

Refer to *Filling the tank* in the *Maintenance and Specifications* chapter for more information.

## Entertainment Systems

### PREMIUM AM/FM STEREO/CASSETTE/SINGLE CD (IF EQUIPPED)

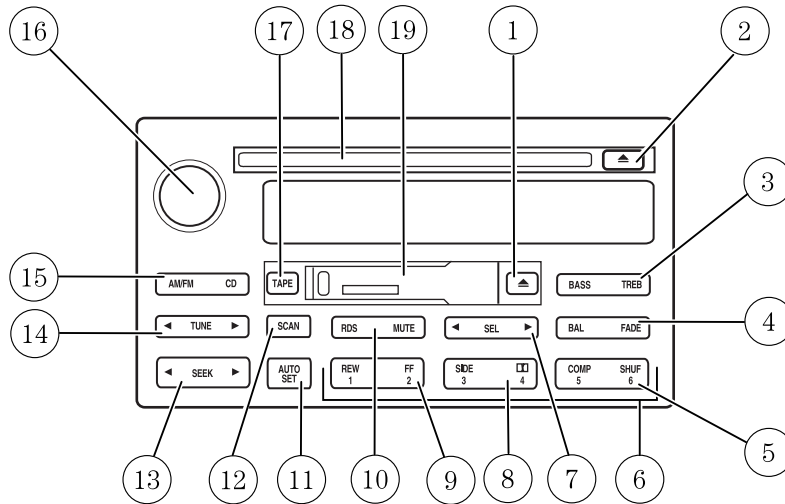

1. **EJ (Eject):** Press to stop and eject a tape.



2. **EJ (Eject):** Press to stop and eject a CD.



3. **BASS:** Allows you to increase or decrease the audio system's bass output. Press BASS then press SEL to decrease ◀ or increase ▶ the bass levels.

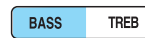

**TREB (Treble):** Allows you to increase or decrease the audio system's treble output. Press TREB then press SEL to decrease ◀ or increase ▶ the treble levels.





## Entertainment Systems

4. **BAL (Balance):** Allows you to shift speaker sound between the right and left speakers. Press BAL then press SEL to shift sound to the left ◀ or right ▶ .



**FADE:** Allows you to shift speaker sound between the front and rear speakers. Press FADE then press SEL to shift the sound to the rear ◀ or the front ▶ .



5. **COMP (Compression):** In CD mode, press to bring soft and loud passages together for a more consistent listening level. Press again to deactivate.



**SHUF (Shuffle):** Press to play CD tracks in random order. Press again to deactivate random play.



6. **Memory preset stations:** To set a memory preset station, tune the radio to the desired station, then press and hold the memory preset control until the sound returns.



7. **SEL (Select):** Use to adjust bass, treble, balance and fade levels.



8. **SIDE:** Press to play the alternate side of the tape.



**Dolby:  Dolby® noise reduction:** Reduces tape noise and hiss; press to activate/deactivate.



The Dolby® noise reduction system is manufactured under license from Dolby Laboratories Licensing Corporation. Dolby® and the double-D symbol are registered trademarks of Dolby® Laboratories Licensing Corporation.

9. **REW (Rewind):** Works in tape and CD modes.



In tape mode, radio play continues until rewind is stopped (with the TAPE control) or the beginning of the tape is reached.

## Entertainment Systems

In CD mode, REW control reverses the CD within the current track.

**FF (Fast Forward):** Works in tape and CD modes.



In the tape mode, tape direction automatically reverses when the end of the tape is reached.

In CD mode, FF advances the CD within the current track.

10. **MUTE:** Press to mute the playing media. Press again to return to playing media.



**Note:** If your vehicle is equipped with the Reverse Sensing System, the audio volume (if set above a certain level) will be lowered to a preset value when the Backup aid tone is sounded.

**RDS:** (Radio Data System): Press RDS to access the clock mode and the RDS features.

RDS must be turned ON to activate the Traffic, Find Program Type and Show functions. To turn RDS ON, put the radio in FM mode then press the RDS button until RDS OFF appears then press SEL control to toggle function ON.

- **Traffic:** Allows you to hear traffic broadcasts. With the feature ON, press SEEK or SCAN to find a station broadcasting a traffic report (if it is broadcasting RDS data). *Traffic information is not available in most U.S. markets.* To activate, press RDS until TRAFFIC OFF appears in the display then use SEL to toggle function ON.
- **FIND Program type:** Allows you to search RDS-equipped stations for a certain category of music format: Classic, Country, Info, Jazz, Oldies, R&B, Religious, Rock, Soft, Top 40. Press RDS until FIND appears in the display then use the SEL control to scroll through the desired music types. Press SEEK or SCAN to find program type.
- **Show TYPE:** Allows you to display radio station call sign or format. To activate, press RDS until SHOW appears in the display, then use the SEL to select NAME or TYPE.

The Federal Communications Commission (FCC) and the Canadian Radio and Telecommunications Commission (CRTC) recommend that FM radio broadcasters use RDS technology to transmit information. FM radio stations are independently operated and individually elect to use RDS technology to transmit station ID and program type as desired.

## Entertainment Systems

**Setting the clock:** Your vehicle is equipped with a separate analog clock. Refer to *Setting the clock* in the Driver Controls Chapter.

11. **AUTOSET:** Press to set first six strong stations into AM, FM1 or FM2 memory buttons; press again to return to the original preset stations. If there are less than six strong stations available on the frequency band, the remaining memory preset controls will all store the last strong station available.



12. **SCAN:** Works in radio, tape and CD modes. Press SCAN for a brief sampling of radio stations, tape selections or CD tracks. Press again to deactivate scan mode.



13. **SEEK:** Works in radio, tape and CD modes. Press to access the previous ◀ or next ▶ listenable radio station, tape selection or CD track.



14. **TUNE:** Works in radio mode. Press ◀/▶ to manually advance down/up the frequency band.



15. **AM/FM/CD:** Press AM/FM to select a radio frequency. Press while in tape or CD mode to return to radio mode. Press CD to enter CD mode and to play a CD already in the system. Press AM/FM to switch between AM, FM1, or FM2 memory preset stations. Press the CD control to toggle between CD and DVD (if equipped).



16. **Power/volume:** Press to turn the system on/off. Turn to raise/lower the volume.

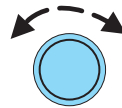

If the volume is set above a certain level and the ignition is turned off, the volume will come back on at a “nominal” listening level when the ignition switch is turned back on. Audio power can also be turned on by pressing the AM/FM select control or the TAPE/CD select control.

## Entertainment Systems

**Speed sensitive volume** (if equipped): Automatically changes the volume slightly with vehicle speed to compensate for road and wind noise. The recommended level is 1–3. Level 0 turns the speed sensitive volume off and level 7 is the maximum setting.

To engage the speed sensitive volume feature, press and hold the volume control for five seconds (with the radio on). Press SEL to increase ◀/decrease ▶ volume compensation levels. The selected level will appear in the display.

17. **TAPE:** Press to begin tape play. Press during fast forward or rewind to stop fast forward or rewind function.

TAPE

18. **CD door:** Insert the disc with the playing side down and printed side up.

**CD units are designed to play commercially pressed 12 cm (4.75 in) audio compact discs only. Due to technical incompatibility, certain recordable and re-recordable compact discs may not function correctly when used in Ford CD players. Irregular shaped CDs, CDs with a scratch protection film attached, and CDs with homemade paper (adhesive) labels should not be inserted into the CD player. The label may peel and cause the CD to become jammed. It is recommended that homemade CDs be identified with permanent felt tip marker rather than adhesive labels. Ball point pens may damage CDs. Please contact your dealer for further information.**

19. **Tape door:** Insert the tape facing the right.

## Entertainment Systems

### AUDIOPHILE SATELLITE READY AM/FM STEREO IN-DASH SIX CD RADIO (IF EQUIPPED)

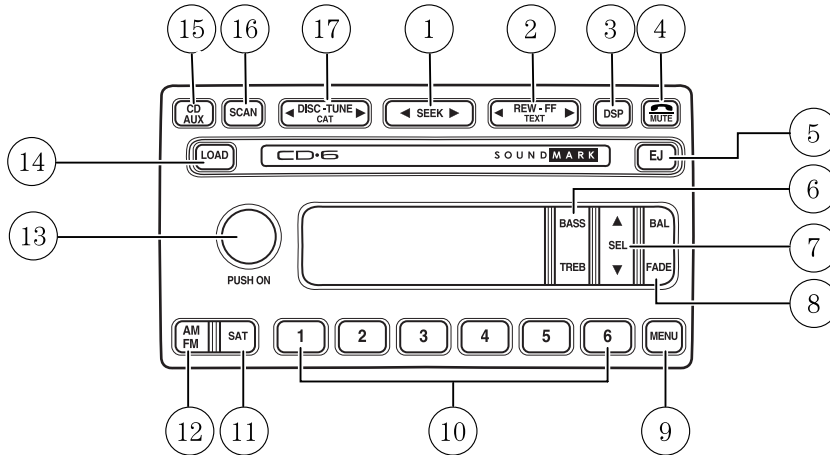

1. **Seek:** Press and release SEEK ◀ / ▶ for previous/next strong station, selection or track.



2. **Rewind:** In CD mode, press until desired selection is reached.



**Fast forward:** In CD mode, press until desired selection is reached.

**TEXT:** TEXT is only available when equipped with Satellite radio. Your Audiophile radio comes equipped with Satellite ready capability. The kit to enable Satellite reception is available through your Lincoln dealer. Detailed Satellite instructions are included with the dealer installed kit.

#### 3. DSP (Digital Signal

**Processing):** Press DSP to access the Ambiance menu. Ambiance gives the feeling of “being there” to your music, creating increased clarity as well as an open and spacious feel to the music. Press SEL to engage/disengage. Turn the volume control to increase/decrease the level of ambiance.

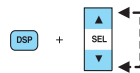

**Occupancy:** Press DSP again to change the occupancy mode to optimize sound for ALL SEATS, DRIVER SEAT or REAR SEATS. Press SEL to scroll through settings.

## Entertainment Systems

4. **Mute:** Press to MUTE playing media; press again to return to playing media



5. **Eject:** Press to eject a CD. Press and hold to eject all loaded discs.



6. **Bass:** Press BASS; then press SEL ▼ / ▲ to decrease/increase the bass output.

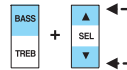

**Treble:** Press TREB; then press SEL ▼ / ▲ to decrease/increase the treble output.



7. **Select:** Use with Bass, Treble, Balance and Fade controls to adjust levels and set the clock.



8. **Balance:** Press BAL; then press SEL ▼ / ▲ to shift sound to the left/right speakers.

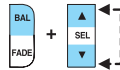

**Fade:** Press FADE; then press SEL ▼ / ▲ to shift sound to the rear/front speakers.

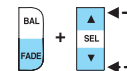

9. **Menu:** Press MENU and SEL to access RDS on/off, Traffic announcement mode, Program type mode, and Shuffle mode.



The Federal Communications Commission (FCC) and the Canadian Radio and Telecommunications Commission (CRTC) recommend that FM radio broadcasters use RDS technology to transmit information. FM radio stations are independently operated and individually elect to use RDS technology to transmit station ID and program type as desired.

**Traffic:** Allows you to hear traffic broadcasts. With the feature ON, press SEEK or SCAN to find a station broadcasting a traffic report (if it is broadcasting RDS data). *Traffic information is not available in most U.S. markets.*

## Entertainment Systems

**FIND Program type:** Allows you to search RDS-equipped stations for a certain category of music format: Classic, Country, Info, Jazz, Oldies, R&B, Religious, Rock, Soft, Top 40.

**Show TYPE:** Displays the station's call letters and format.

**Shuffle:** When in CD mode, press to play tracks in a random order. Press MENU until SHUF appears in the display. Use SEL to select SHUF DISC, SHUF TRAC or SHUF OFF.

**Compression:** Brings soft and loud CD passages together for a more consistent listening level when in CD mode. Press MENU until compression status is displayed. Press the SEL control to enable the compression feature when COMP OFF is displayed. Press the SEL control again to disable the feature when COMP ON is displayed.

**Setting the clock:** Your vehicle is equipped with a separate in-dash mounted clock. Please refer to *Setting the clock* in the Driver Controls chapter for instructions on how to set the clock.

10. **Memory presets:** To set a station: Select frequency band AM/FM; tune to a station, press and hold a preset button until sound returns.



11. **SAT (if equipped):** Your Audiophile radio comes equipped with Satellite Ready capability. The kit to enable the Satellite reception is available through your Lincoln dealer. Detailed satellite instructions are included with the dealer installed kit.



12. **AM/FM:** Press to select AM/FM frequency band.



**Autoset:** Allows you to set the strongest local radio stations without losing your original manually set preset stations for AM/FM1/FM2. Press and momentarily hold AM/FM. AUTOSET will flash on the display. When the six strongest stations are filled, the station stored in preset 1 will begin playing. If there are less than six strong stations, the system will store the last one in the remaining presets. Press again to disengage.

## Entertainment Systems

13. **Power/volume:** Press to turn ON/OFF; turn to increase or decrease volume levels.



**Speed sensitive volume:** Radio volume changes automatically and slightly with vehicle speed to compensate for road and wind noise. Recommended level is 1–3. Level 0 turns the feature off and level 7 is the maximum setting. Press and hold the volume control for five seconds. Then press SEL to increase (▲) or decrease (▼) the volume setting. The level will appear in the display.

14. **Load:** Press to load a CD. Press and hold to load up to six discs.



15. **CD AUX:** Press to access CD to toggle between CD and DVD (if equipped).



**CD units are designed to play commercially pressed 12 cm (4.75 in) audio compact discs only. Due to technical incompatibility, certain recordable and re-recordable compact discs may not function correctly when used in Ford CD players. Irregular shaped CDs, CDs with a scratch protection film attached, and CDs with homemade paper (adhesive) labels should not be inserted into the CD player. The label may peel and cause the CD to become jammed. It is recommended that homemade CDs be identified with permanent felt tip marker rather than adhesive labels. Ballpoint pens may damage CDs. Please contact your dealer for further information.**

16. **Scan:** Press SCAN to hear a brief sampling of radio stations or CD tracks. Press again to stop.



17. **Disc/Tune:** Press ◀ or ▶ to manually tune down/up the radio frequency band, or to listen to the previous/next track on the CD.





## Entertainment Systems

**CAT:** CAT is only available when equipped with Satellite Radio. Your Audiophile radio comes equipped with Satellite ready capability. The kit to enable Satellite reception is available through your Lincoln dealer. Detailed Satellite instructions are included with the dealer installed kit.



For information regarding SIRIUS Satellite Radio, please call toll-free 888-539-SIRIUS (888-539-7474) or visit the SIRIUS website at [www.siriusradio.com](http://www.siriusradio.com)

### REAR SEAT RADIO CONTROLS (IF EQUIPPED)

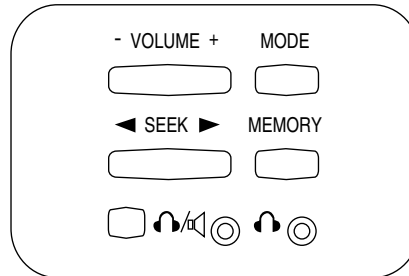
If your vehicle is equipped with a front row console, then it is also equipped with rear seat radio controls. This feature allows front and middle seat passengers to listen to different media sources (radio, cassette, CD or DVD) simultaneously. (However, the front and middle-seat passengers cannot listen to two different radio stations at the same time.)



When the rear seat controls are activated, rear seat passengers can use the controls to change the playing media for all passengers (Single Play mode). In this mode, all speakers will play audio from the same media source for all passengers to hear. To activate the rear seat radio controls:

- Press the memory preset controls 3 and 5 at the same time. A headphone icon  will illuminate in the radio display, indicating the rear seat radio controls are active.
- Press memory preset controls 3 and 5 a second time to deactivate the rear seat controls. The headphone icon  will turn off in the radio display.

If there is a discrepancy between the rear seat controls and the front audio controls (such as both trying to listen to the same playing media), the front audio system will receive the desired selection.

## Entertainment Systems

To activate Dual Play mode (rear seat passengers listen to a different playing media than the front seat passengers):

- Press the speaker/headphone control.
- Press the MODE control to change audio sources (for headphone mode only)
- Use the SEEK, VOLUME and MEMORY controls to make adjustments to the playing media.
- Dual Play mode may also be activated by pressing memory presets 2 and 4 simultaneously on the front audio controls.

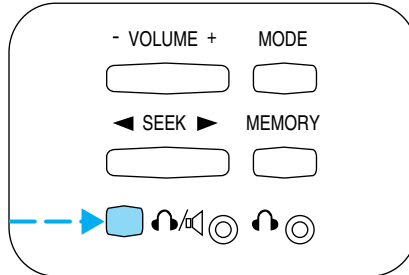

The rear speakers mute and rear seat passengers have audio (for their selected media) available through their headphones.

### To adjust the volume

The volume control allows the rear seat passengers to adjust the volume level of the audio system.

Press the + control to increase volume.

Press the - control to decrease volume.

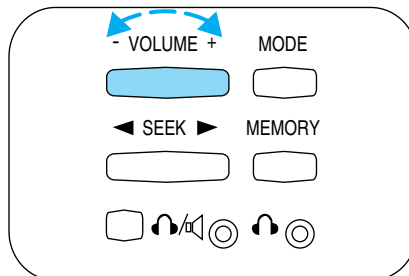

From the rear seat controls, volume control can be set no higher than the current radio setting unless the speakers are turned off.

## Entertainment Systems

### Turning the rear speakers on and off

Press the headphone/speaker control to turn the rear speakers on (Single Play mode) or off (Dual Play mode).

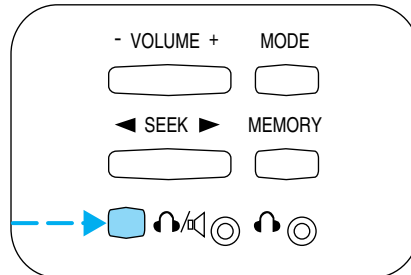

### Using headphones/Dual Play mode

Plug a 3.5 mm headphone (not included) into the  jack. Press the speaker on/off control to operate the headphones. DUAL PLAY illuminates in the radio display and the fade control is disabled, signaling that Dual Play has been activated.

The rear speakers will cut out once the speaker on/off control is pressed. The front speaker will remain playing for the front passengers. Press the control again to deactivate the headphones. SINGLE PLAY illuminates in the radio display and the fade control is enabled, signaling that Dual Play mode has been deactivated.

To enable Dual Play, the rear seat controls must be active and  illuminated in the radio display.

### Mode select

Push the MODE control to toggle between AM, FM1, FM2, tape (if equipped), CD, CD changer (if equipped) or DVD (if equipped). If in Dual Play mode, SHARED illuminates in the radio display when the front and rear modes are set to the same media.

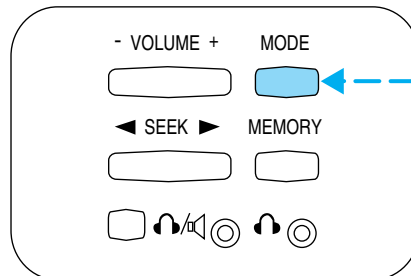

## Entertainment Systems

### Memory preset control

Push the MEMORY control successively to allow rear seat passengers to scroll through the 6 memory presets in AM, FM1 or FM2.

Push the MEMORY control in CD mode (if equipped) to advance to the next disc.

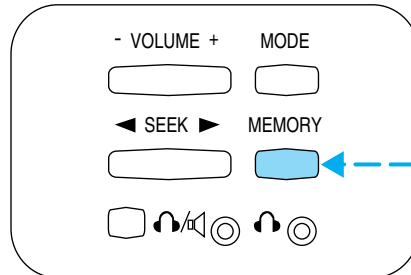

### Seek function

- In radio mode, press ◀ to find the next listenable station down the frequency band.
- In radio mode, press ▶ to find the next listenable station up the frequency band.
- In tape mode (if equipped), use the SEEK function to access the next ▶ or previous ◀ selection.
- In CD mode (if equipped), use the SEEK function to access the next ▶ or previous ◀ selection.

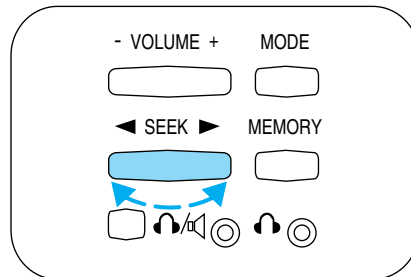

### Parental control

Press the memory preset controls 3 and 5 simultaneously on the front seat controls to disable the rear seat controls. They will remain disabled until the front seat passengers “enable” them again by simultaneously pressing the 3 and 5 preset controls. The settings of the front seat controls will always override those of the rear seat controls.



## Entertainment Systems

### **RADIO FREQUENCIES**

AM and FM frequencies are established by the Federal Communications Commission (FCC) and the Canadian Radio and Telecommunications Commission (CRTC). Those frequencies are:

AM - 530, 540–1700, 1710 kHz

FM- 87.7, 87.9–107.7, 107.9 MHz

### **RADIO RECEPTION FACTORS**

There are three factors that can affect radio reception:

- Distance/strength: The further you travel from an FM station, the weaker the signal and the weaker the reception.
- Terrain: Hills, mountains, tall buildings, power lines, electric fences, traffic lights and thunderstorms can interfere with your reception.
- Station overload: When you pass a broadcast tower, a stronger signal may overtake a weaker one and play while the weak station frequency is displayed.

### **CASSETTE/PLAYER CARE**

Do:

- Use only cassettes that are 90 minutes long or less.
- Tighten very loose tapes by inserting a finger or pencil into the hole and turning the hub.
- Remove loose labels before inserting tapes.
- Allow tapes which have been subjected to extreme heat, humidity or cold to reach a moderate temperature before playing.
- Clean the cassette player head with a cassette cleaning cartridge after 10–12 hours of play to maintain good sound/operation.

Don't:

- Expose tapes to direct sunlight, extreme humidity, heat or cold.
- Leave tapes in the cassette player for a long time when not being played.

### **CD/CD PLAYER CARE**

Do:

- Handle discs by their edges only. Never touch the playing surface.
- Inspect discs before playing. Clean only with an approved CD cleaner and wipe from the center out.

## Entertainment Systems

Don't:

- Expose discs to direct sunlight or heat sources for extended periods of time.
- Insert more than one disc into each slot of the CD changer magazine.
- Clean using a circular motion.

**CD units are designed to play commercially pressed 12 cm (4.75 in) audio compact discs only. Due to technical incompatibility, certain recordable and re-recordable compact discs may not function correctly when used in Ford CD players. Irregular shaped CDs, CDs with a scratch protection film attached, and CDs with homemade paper (adhesive) labels should not be inserted into the CD player. The label may peel and cause the CD to become jammed. It is recommended that homemade CDs be identified with permanent felt tip marker rather than adhesive labels. Ball point pens may damage CDs. Please contact your dealer for further information.**

### AUDIO SYSTEM WARRANTY AND SERVICE

Refer to the *Warranty Guide* for audio system warranty information. If service is necessary, see your dealer or qualified technician.

**Whenever a warning is received, the radio volume will be lowered to a volume that will allow the tones to be heard. The radio volume will return to the previous level after the warning goes away.**

### REAR SEAT ENTERTAINMENT DVD SYSTEM (IF EQUIPPED)

Your vehicle may be equipped with a Rear Seat Entertainment DVD System which allows you to watch DVDs, play music CDs and to plug in and play video game systems. Please review this material to become familiar with the system features and safety information.

## Entertainment Systems

### DVD player controls

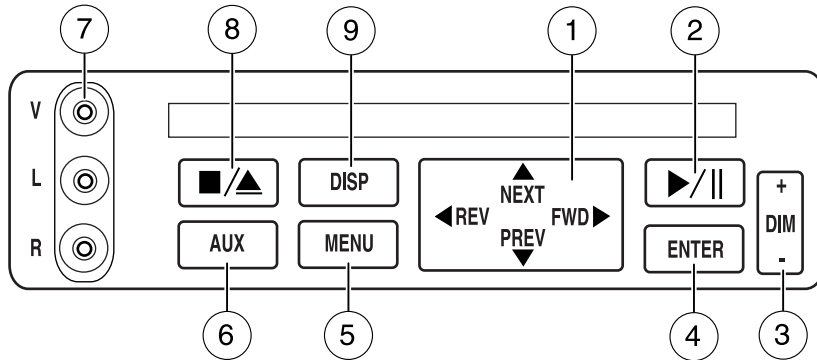

#### 1. **MAIN** control

- **NEXT** — Press to access the next track on the CD, the next chapter on the DVD, or to go up in cursor mode.
- **PREV** — Press to access the previous track on the CD, the previous chapter on the DVD, or to go down in cursor mode.
- **REV** — Press to reverse in CD and DVD play modes or to move the cursor left in the menu active mode.
- **FWD** — Press to advance in CD and DVD play modes or to move the cursor right in the menu active mode.

#### 2. **PLAY/PAUSE** control

Press to playback or pause the DVD.

#### 3. **DIM** control

Adjust to increase (+) or decrease (-) the amount of brightness on the screen.

#### 4. **ENTER** control

Press to select the function pointed to within the active menu. May also be used by some user interactive discs during movie play.

#### 5. **MENU** control

Press to bring up the disc menu.

#### 6. **AUX** control

Press to switch DVD player from play mode to auxiliary mode.

## Entertainment Systems

### 7. Auxiliary jacks

Insert lines for standard video game players.

### 8. STOP/EJECT control

Press once to stop DVD play. Press again to eject the DVD.

### 9. DISPLAY (DISP) control

Press to enable on screen display of player menu and user display adjustments.

### DVD control features

#### Menu control

Press the MENU control to enter into MENU mode. This allows you to move and choose within the DVD generated menu structure. Once in MENU mode:

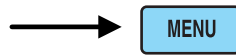

- Press the NEXT control to move the cursor one position upward



- Press the PREV control to move the cursor one position downward

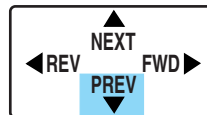

- Press the REV control to move the cursor left one position





## Entertainment Systems

- Press the FWD control to move the cursor right one position



### **Next/Previous control**

The NEXT (up) and PREV (down) controls allow you to access the next or previous track on a CD or chapter on a DVD. When pressed, the playing audio will mute momentarily while the next chapter is accessed. Press and hold to advance or reverse multiple tracks or chapters.

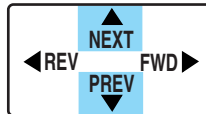

### **REV/FWD control**

Press the REV/FWD control during playback mode to reverse or advance at a normal speed. Press the REV/FWD control again to disengage the reverse/advance action and return to normal playback mode



### **Enter control**

The ENTER control allows you to select items when in MENU mode.

Press the ENTER control to select the desired highlighted item.



### **CD play mode**

Press NEXT during CD play to advance to the next track. If you press NEXT during the last track, the system will wrap around to the first track and begin play.

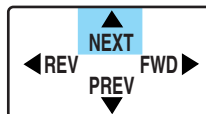

### **Slow play mode**

To enter slow play mode, press the PLAY/PAUSE control. Once the system is in pause mode, press the



## Entertainment Systems

FWD or REV control for slow motion playback. Three different speeds are available depending on how long the control is held. Press the control once for slow motion playback. Press the control again to disengage slow motion playback. Press the PLAY/PAUSE control to return to normal playback mode.

### User menu mode

To adjust the display setting, press DISP once and the player menu will appear. Press DISP again to adjust the display setting. Use the arrow controls and the ENTER controls to select the various screen settings. (Available screen selections are 16x9, Normal, 4x3 and Zoom).



The DVD player will read the disc type and configure the display accordingly. Some movies have a wide screen movie format to fit a normal 4x3 screen. In this case, the movie will have black bars on the top and bottom. When shown on the screen, it may appear as a small screen within the wide screen. It may be desirable to view this type of movie in zoom mode. To enter zoom mode, press DISP once for the player menu and again to adjust the display setting. Select zoom from the screen settings by using the arrow and ENTER controls.

### Remote control

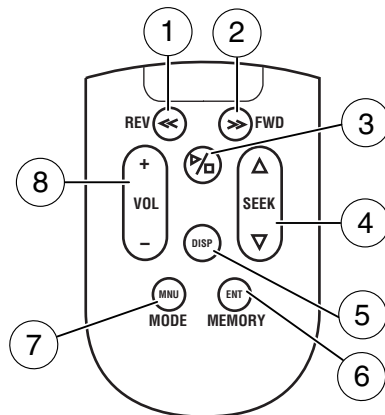

#### 1. **REWIND** control

Press to reverse the direction of the DVD movie.

## Entertainment Systems

### 2. **FAST FORWARD** control

Press to advance the direction of the DVD movie.

### 3. **PLAY/STOP** control

Press to play or stop the DVD movie.

### 4. **SEEK** control

Press to reverse or advance the chapter of the DVD or the track of the CD.

### 5. **DISPLAY (DISP)** control

Press to enable on screen display of player menu and user display adjustments. Once the display is on, use SEEK to choose the desired screen setting.

### 6. **ENTER (ENT) MEMORY** control

In DVD playback mode, press the control to select a designated item in menu mode.

In stop mode, press the control to select the next radio memory preset.

### 7. **MNU/MODE** control

In DVD playback mode, press to access the disc menu.

In stop mode, press to change to a different playing media (e.g. AM, FM, CD . . . )

### 8. **VOLUME** control

Press to increase (+) or decrease (-) volume level.

### Battery replacement

Batteries are supplied with the remote control unit. Since all batteries have a limited shelf life, replace them when the unit fails to control the DVD player. There is a LED indicator light on the remote control that will illuminate when any control is pressed.

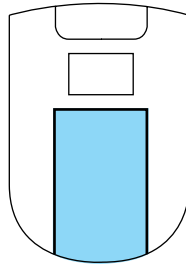

Slide the battery cover off as shown on the remote control to access the batteries.

The remote control unit uses two AAA batteries.

## Entertainment Systems

### Parental control

To enable or disable your Rear Seat Entertainment DVD System, simultaneously press the memory preset controls 3 and 5 on the radio face.



For further information about the Rear Seat Controls, refer to *Rear Seat Controls* section in this chapter.

### Wireless headphones

Your system is equipped with 2 sets of wireless headphones. (Two AAA batteries are needed to operate the headphones.) Batteries are included.



To install the batteries, lightly press down on the top of the left earpiece and slide the cover off.

When replacing the batteries, use two new batteries (alkaline recommended) and install them with the correct (+) and (-) orientation.

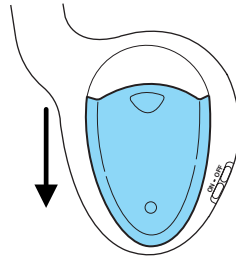

## Entertainment Systems

### **Wireless headphone operation**

To operate the headphones:

- Press the ON/OFF button on the left-hand earpiece. The LED light on the right-hand earpiece will illuminate. Press again to turn off.
- Adjust the headphones to comfortably fit your head.
- Adjust the volume control to a comfortable listening level.

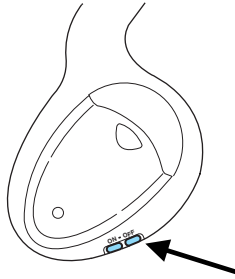

**Note:** The volume level of the wireless headphones can only be controlled by the thumbwheel. Neither the remote control nor the rear seat controls will affect the volume output of the wireless headphones.

When not using the headphones, shut them off to preserve battery power. The headphones will automatically turn off after five minutes if they have not received an infrared audio signal from the overhead pod.

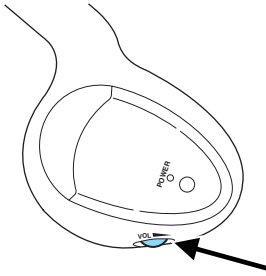

Ensure that the line of sight between the headphone and infrared transmitter (mounted on the DVD housing) is not obstructed.

### **Liquid Crystal Display (LCD) flip-down screen**

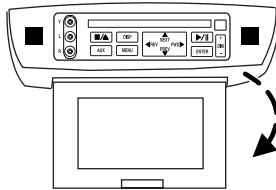

The screen rotates down to view and into the housing to store when not in use. Be sure the screen is latched into the housing when being stored.

## Entertainment Systems

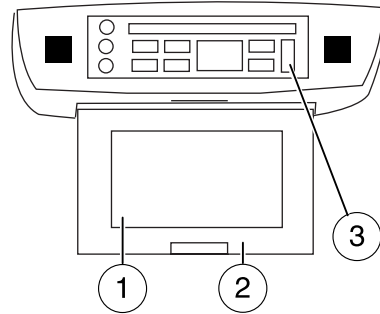

1. 7.0" (diagonal) active matrix liquid crystal display (LCD) screen.
2. Screen housing.
3. Dimmer switch. Press +/- to increase/decrease the brightness of the screen.

### Playback and format

- The DVD player of your Rear Seat Entertainment DVD System can only be used in the "playback" mode. (The DVD player does not offer a record feature.)
- The system plays standard CDs or DVDs.
- The DVD player is only capable of playback of DVDs and CDs. The player is not compatible with CDR/RW media.

### Rear Seat Entertainment DVD System protection circuits

#### **High temperature sensor circuit**

- Excessively high temperatures may cause damage to the DVD player.
- When the temperature of the DVD player becomes too hot, the high temperature sensor circuit stops machine operation. DVD/CD HOT will illuminate in the radio display.
- The DVD player will remain inactive until it cools to a normal operating temperature. Length of time to cool will vary depending on conditions.

### General operating tips

- When the engine is not running, use the system sparingly. Otherwise, it will run the battery down.

## Entertainment Systems

- When the ignition is turned to OFF, the Rear Seat Entertainment DVD System is also turned OFF. When the ignition is turned ON, the system will begin playback from the last selected media source when the play control is pressed.
- To disable the DVD player, simultaneously press the 3 and 5 memory presets on the radio face. To enable the DVD player again, press the 3 and 5 presets simultaneously.
- The DVD player is only capable of reading the bottom side of a disc. When inserting a single sided disc, the label should be up. For a multi-sided disc, the desired play side should be down when the disc is inserted into the player.
- The DVD player is only capable of playback of DVDs and CDs. The player is not compatible with CDR/RW media.
- DVDs are formatted by regions. This DVD system can only play region 1 DVDs (DVDs manufactured for U.S. and Canada).

**This unit is designed to play commercially pressed 12 cm (4.75 in) audio compact discs and DVDs only. Due to technical incompatibility, certain recordable and re-recordable compact discs may not function correctly when used in Ford DVD/CD players. Irregular shaped discs, discs with a scratch protection film attached, and discs with homemade paper (adhesive) labels should not be inserted into the player. The label may peel and cause the disc to become jammed. It is recommended that homemade discs be identified with permanent felt tip marker rather than adhesive labels. Ball point pens may damage discs. Please contact your dealer for further information.**

### Inserting a CD/DVD

Partially insert the CD/DVD into the slot and the system will fully pull in the disc. Inserting the disc too far could cause the disc to jam in the system.

Inserting a CD/DVD into the DVD player automatically turns the power ON and playback should begin.

The counter is automatically reset to 0:00:00.

### Removing a CD/DVD

1. Press the STOP/EJECT control to stop playback.
2. Press the STOP/EJECT control again to eject the CD/DVD.

If the CD/DVD is not removed within the allotted time, the system will pull the CD/DVD back into the system for safety purposes. If the

## Entertainment Systems

CD/DVD will not eject from the system, press and hold the EJECT control for approximately 2 seconds. The disc should eject whether the vehicle ignition is ON or OFF.

### **Playing a video game/auxiliary device**

1. Connect the video line from your video game device to the YELLOW auxiliary input jack.
2. Connect the left and right audio lines to the WHITE and RED auxiliary input jacks respectively.
3. Press the MODE control until DVD/CD AUX (no disc in player) or DVD/CD play (disc in player) illuminates in the radio display. If a disc is in the system, playback should begin. To enable the aux inputs, press the STOP control or press the AUX control on the DVD player.

### **On-screen indicators**

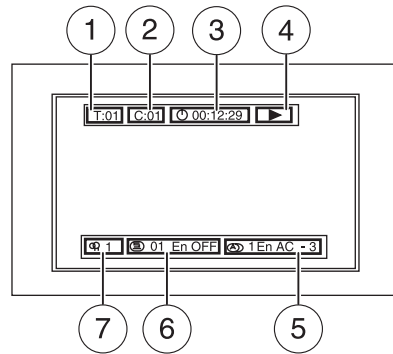

Each time a control is pressed, the operational status of the DVD player is shown on the screen. The following are some possible indicators:

1. CD track
2. DVD chapter
3. SYSTEM COUNTER — displays current viewing time of desired media. (HOURS:MINUTES:SECONDS)
4. DVD/ CD STATUS (PLAY/FF/REW/PAUSE)
5. AUDIO OUTPUT (not changeable)
6. Subtitles (specific language type - English or Spanish, dependent on disc capability and ON/OFF selection.)



## Entertainment Systems

7. Camera angle (of picture) - Adjustable with cursor controls and ENTER control.

### Safety information

Read all of the safety and operating instructions before operating the system and retain for future reference.

Do not attempt to service, repair or modify the Rear Seat Entertainment DVD System. See your Ford or Lincoln Mercury dealer.

Do not insert foreign objects into the DVD compartment.



The front glass on the liquid crystal display (LCD) flip-down screen may break when hit with a hard surface. If the glass breaks, do not touch the liquid crystalline material. In case of contact with skin, wash immediately with soap and water.

**Do not expose the liquid crystal display (LCD) flip-down screen to direct sunlight or intensive ultraviolet rays for extensive periods of time. Ultraviolet rays deteriorate the liquid crystal.**

Be sure to review user manuals for video games and video game equipment when used as auxiliary inputs for your Rear Seat Entertainment DVD System.

Do not operate video games or video equipment if the power cords and/or cables are broken, split or damaged. Carefully place cords and/or cables where they will not be stepped on or interfere with the operation of seats and/or compartments.

Disconnect video games and video equipment power cords and/or cables when not in use.

Avoid touching auxiliary input jacks with your fingers. Do not blow on them or allow them to get wet or dirty.

Do not clean any part of the DVD player with benzene, paint thinner or any other solvent.

**Whenever a warning is received, the radio volume will be lowered to a volume that will allow the tones to be heard. The radio volume will return to the previous level after the warning goes away.**

### Federal Communication Commission (FCC) Compliance

Changes or modifications not approved by Ford Lincoln Mercury could void user's authority to operate the equipment. This equipment has been

## Entertainment Systems

tested and found to comply with the limits for a Class B digital device, pursuant to Part 15 of the FCC Rules. These limits are designed to provide reasonable protection against harmful interference in a residential installation. This equipment generates, uses and can radiate radio frequency energy and, if not installed and used in accordance with the instructions, may cause harmful interference with radio communications.

However, there is no guarantee that interference will not occur in a particular installation. If this equipment does cause harmful interference to radio or television reception, which can be determined by turning the equipment off and on, the user is encouraged to consult the dealer or an experienced radio/TV technician for help.

### **Care and service of the DVD player**

#### ***Environmental extremes***

DVD players that are subjected to harsh environmental conditions may be damaged or perform at less than maximum capability. To avoid these outcomes, whenever possible avoid exposing your DVD player to:

- extremely hot or cold temperatures.
- direct sunlight.
- high humidity.
- a dusty environment.
- locations where strong magnetic fields are generated.

#### ***Temperature extremes***

When the vehicle is parked under direct sunlight or in an extremely cold place for a long period of time, wait until the cabin temperature of the vehicle is at normal temperature before operating the system.

#### ***Humidity and moisture condensation***

Moisture in the air will condense in the DVD player under extremely humid conditions or when moving from a cold place to a warm one. If moisture condensation occurs, do not insert a CD or DVD into the player. If one is already in the player, remove it. Turn the DVD player ON to dry the moisture before inserting a DVD. This could take an hour or more.

#### ***Cleaning the liquid crystal display (LCD) flip-down screen***

Clean the display screen by applying a small amount of water or any ammonia-based household glass cleaner directly to a soft cloth. Rub the

## Entertainment Systems

screen gently until the dust, dirt or fingerprints are removed. Do not spray the screen directly with water or glass cleaning solvents. Overspray from these fluids could drip down into the internal electronics of the screen and cause damage. Do not apply excessive pressure while cleaning the screen.

### ***Foreign substances***

Exercise care to prevent dirt and foreign objects from entering the DVD player compartment. If liquid is accidentally spilled onto the system, immediately turn the system OFF and consult a qualified service technician.

### **Cleaning CDs and DVDs**

Inspect all discs for contamination before playing. If necessary, clean discs only with an approved CD cleaner and wipe from the center out to the edge. Do not use circular motion.

### **Cleaning the DVD player exterior**

Clean the exterior of the DVD player with a damp cloth. Do not use CD cleaning kits or CDs intended to clean the interior of your DVD player. Use of these products may damage your system.

### **LINCOLN NAVIGATION SYSTEM (IF EQUIPPED)**

Your vehicle may be equipped with a Lincoln Navigation System which allows you to listen to the radio, play CDs and also navigate the vehicle using a navigation DVD.

### ***THX audio system (if equipped)***

Your vehicle may be equipped with the THX® certified premium audio system. This system creates optimal acoustic quality for all seating positions and road conditions.



The system offers an advanced speaker system, amplifier, subwoofer and equalizer.

Your Lincoln Navigation System has a large range of features, yet is easy to use. Guidance is shown on the display screen and is supplemented with voice prompts. The display screen provides full information for operating the system through use of menus, text screens and map displays. Screen selections are made by touching the desired selection on the screen.

## Entertainment Systems

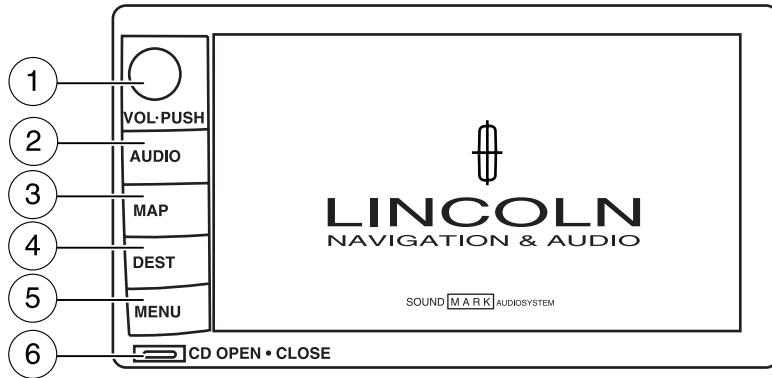

1. **VOL-PUSH:** Press to turn the system ON/OFF. Turn to adjust the audio volume level.
2. **AUDIO:** Press to enter audio mode and access radio, CD, CDDJ, DVD (if equipped) settings.
3. **MAP:** Press to enter map mode and view your current vehicle position on the map. Press and hold to obtain additional position information. This will not function without a map DVD loaded.
4. **DEST:** Press to enter Destination Entry mode. This allows you to enter a destination and route to it. With an active route, pressing DEST allows the user to request a Detour, display entire route, select route preferences, or change or cancel the destination. This will not function without a map DVD loaded.
5. **MENU:** Press to access system settings such as display, brightness, clock mode (if equipped), etc.
6. **CD OPEN CLOSE:** Press to open/close the display screen and access the CD player.

### **Cold temperature advisory**

When operating the system below 32° Fahrenheit (0° Celsius), the display screen requires 20–30 minutes warm-up to achieve maximum brightness. Ensure that the system display setting is set to DAY mode until maximum brightness is achieved (refer to *Menu mode* section). Once maximum brightness is achieved, revert to AUTO mode display setting.

## Entertainment Systems

### Initial map display

After pressing AGREE to the initial WARNING screen, you will move into the initial map screen which shows the current vehicle location. Pressing the globe icon will take you to the user settings — audible feedback, navigation units, language and clock (if equipped).



### Quick Start — How to get going

#### To play a radio station:

1. Ensure that the vehicle ignition is on.
2. Press AUDIO.

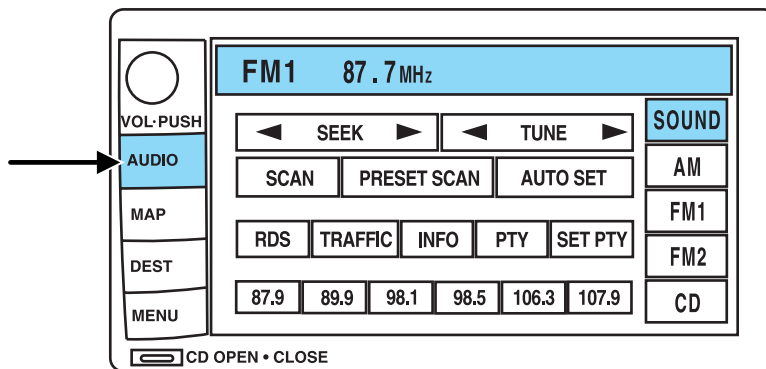

3. Select AM, FM1 or FM2.
4. Press TUNE to adjust manually up (▶) or down (◀) the frequency band.
5. Press SEEK to find the next strong station up (▶) or down (◀).

**Note:** If PTY (program type) is selected, the station selection will be limited. Refer to *Program Type (PTY)* for further information.

## Entertainment Systems

### To play a previously loaded CD:

1. Ensure that the vehicle ignition is on.
2. Press AUDIO.
3. Press CD to select a CD which is already loaded. (NO CD will appear in the display if there are no CDs loaded into the system). Use the controls (1–6) to select the desired CD.
4. CD will begin to play.

### To load CDs:

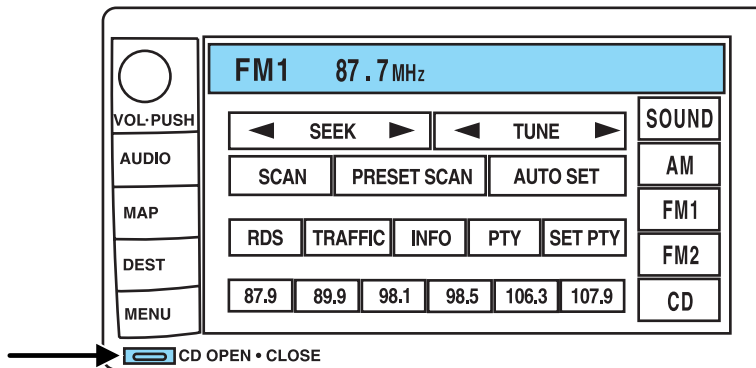

1. Press CD OPEN CLOSE at the bottom of the screen to load a CD. (The screen will open).
2. Press LOAD and select the desired slot. Or, press and hold LOAD to auto load all available slots. The slot indicator lights blink rate will increase when the system is ready to accept a disc. Push CD OPEN CLOSE to close the screen. Once closed, the CD will begin to play.
3. Use the touch controls to advance tracks, scan, pause, etc.

### To use the Navigation system:

1. Ensure that the vehicle ignition is on, and the navigation DVD is loaded into the navigation DVD player. Refer to *Loading the map DVD* or *Navigation system — DVD location* in the Index for your vehicle's navigation DVD location.

## Entertainment Systems

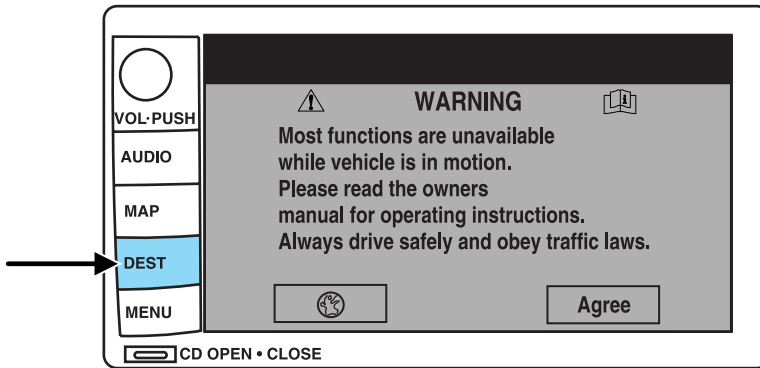

2. Press DEST. The warning screen will appear. After reading, press AGREE. The screen will show a map with your current location. Press DEST again.

3. Select the desired type of destination entry. You may select “Address”, “Point of Interest”, “Emergency” or “Previous Dest” from the first screen.

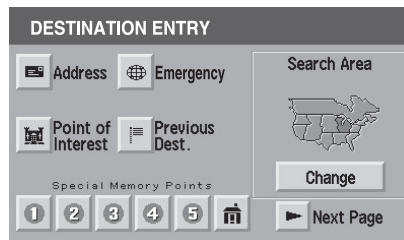

Or, press “▶ Next Page” to access selections of “Memory Point”, “Select from map”, “Freeway Ent/Exit” and “Special Memory Points.” After making your selection, enter any required information.

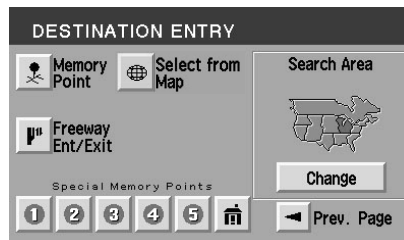

## Entertainment Systems

4. Press DEST at the bottom of the map screen.
5. Choose the desired route by pressing the NEXT button (if it appears). There can be up to three alternative routes.
6. Press START to begin the navigation guidance.

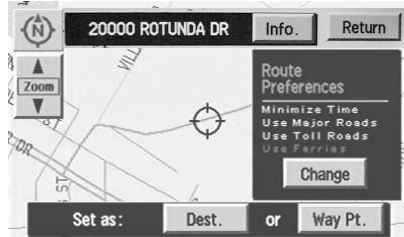

### To adjust the voice guidance volume:

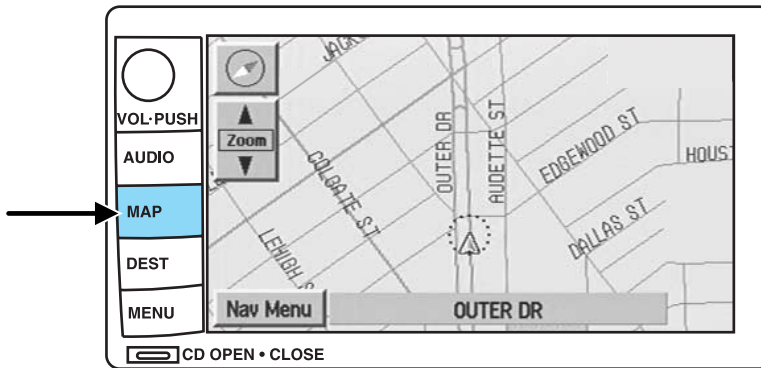

1. Press the MAP hard key.
2. Press “Nav Menu” at the bottom left hand corner of the screen.
3. Press On/Off to turn the voice guidance option on/off. Use the numeric keys (1–7) to determine the volume level of the guidance voice prompts.



### **Voice activated commands (if equipped)**

Your Lincoln Navigation System (LNS) may be equipped with a voice activated feature which allows you to “speak” certain commands to the system. Speaking clearly will help to ensure that the system correctly responds to your commands. Ensure that the commands are spoken in English (not any other language) and that they are spoken exactly as they are written, or they may not function.



## Entertainment Systems

Press VOICE briefly (on your steering wheel controls) and the voice icon  appears on the Navigation display. Press the REPEAT button or arrow on your steering wheel controls to hear the previous command repeated from the navigation system.

The voice activated command feature will not operate if a map DVD is not inserted into the navigation DVD unit.

At any time, you may say these commands to change modes:

- Radio
- AM
- FM1
- FM2
- CD
- Power on
- Audio on
- Audio off
- Power off
- CD Changer (if equipped)
- DVD (if equipped)

During normal radio operation, you may say:

- Seek up
- Seek down

Disc operation commands you may say when using a rear seat DVD (if equipped):

- Track up
- Previous track
- Disc down
- Previous disc
- Track down
- Disc up
- Next disc

During CDDJ or in-dash CD play, you may say:

- Track up
- Previous track
- Next disc
- Previous disc
- Track down
- Disc up
- Disc down

To change the screen display, you may say the following commands:

- Screen off
- Day mode on
- Night mode on
- Auto mode on
- Screen day mode
- Screen night mode
- Screen auto mode

**Note:** If you say “Screen off”, you must touch the screen in order to activate the screen again. The screen will not turn on again with a voice command.

## Entertainment Systems

Commands that jump over screens:

- Current position
- Map
- Current location

While in navigation map mode, the following commands are available:

- Zoom in
- Minimum scale
- North up
- Heading up
- Map direction
- Mark this point
- Zoom out
- Maximum scale
- Change to North up
- Change to heading up
- Change map direction
- Mark

While in navigation POI mode, the following commands are available by voice activation:

- Automobile club
- Auto service & maintenance
- Gas station
- Parking garage
- ATM
- City hall
- Community center
- Exhibition center
- Higher education
- College
- Library
- School
- Casino
- Marina
- Park & recreation
- Performing arts
- Skiing
- Stadium
- Winery
- I'm hungry
- American food
- AAA (Triple A)
- Auto service
- Gas
- Parking lot
- Bank
- Civic center
- Convention center
- Court house
- University
- Hospital
- Police station
- Amusement park
- Golf course
- Museum
- Parks & recreation
- Ski resort
- Sports complex
- Tourist attraction
- Restaurant
- American restaurant
- Chinese restaurant

## Entertainment Systems

- Chinese food
- Continental food
- French food
- Italian food
- Japanese food
- Mexican food
- Seafood
- Other food
- Shopping mall
- Airport
- Ferry terminal
- Hotel
- Rental car agency
- Rest stop
- Train station
- City center
- Commuter rail station
- Continental restaurant
- French restaurant
- Italian restaurant
- Japanese restaurant
- Mexican restaurant
- Seafood restaurant
- Other restaurant
- Shopping
- Grocery store
- Bus station
- Historical monument
- Park and ride
- Rest area
- Tourist information
- Business facility
- POI off

While in navigation destination (DEST) mode, the following commands are available:

- Home
- Previous starting point
- Next way point map
- Second way point map
- Fourth way point map
- Destination map
- Cancel destination
- Go home
- Go starting point
- First way point map
- Third way point map
- Fifth way point map
- Delete destination

While in navigation guidance mode, the following commands are available by voice activation:

- Repeat guidance
- Louder
- Voice guidance off
- Open guidance screen
- Arrow guidance
- Repeat voice
- Softer
- Voice guidance on
- Close guidance screen
- Arrow guide

## Entertainment Systems

- Change to arrow guidance
- Turn list guidance
- Change to turn list guidance
- Entire route map
- Route overview
- Detour
- Change to arrow guide
- Turn list guide
- Change to turn list guide
- Entire route
- Reroute
- Detour entire route

Navigation help commands you may speak at any time:

- Help
- Destination
- Radio
- Map help
- Guidance help
- Disc help
- Map
- Guidance
- Disc
- Destination help
- Radio help

### Audio mode

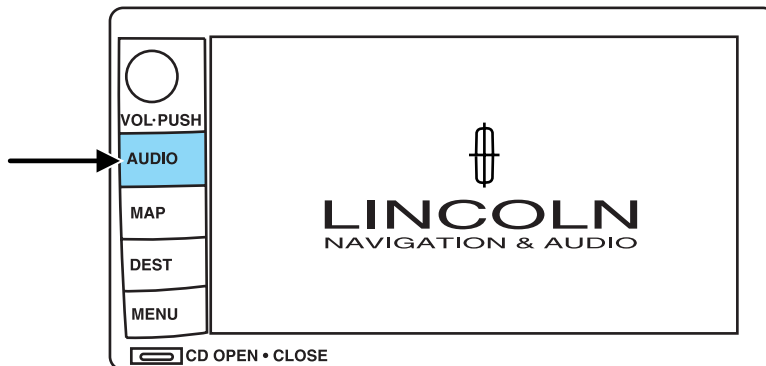

Your Lincoln Navigation Audio System has many features including a full range of audio functions. To access these functions, press AUDIO on the main bezel. This will take you into audio mode.

## Entertainment Systems

### **Volume/power control**

Press knob to turn the audio system on/off. Turn to raise or lower volume. The levels will be displayed on the screen.

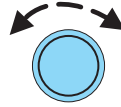

To activate the navigation mode, press MAP or DEST.

To adjust the navigation voice output level, select the NAV MENU button via the map screen.

### **Speed compensated volume (SCV)**

With this feature, radio volume changes automatically with vehicle speed to compensate for road and wind noise. To engage the SCV feature:

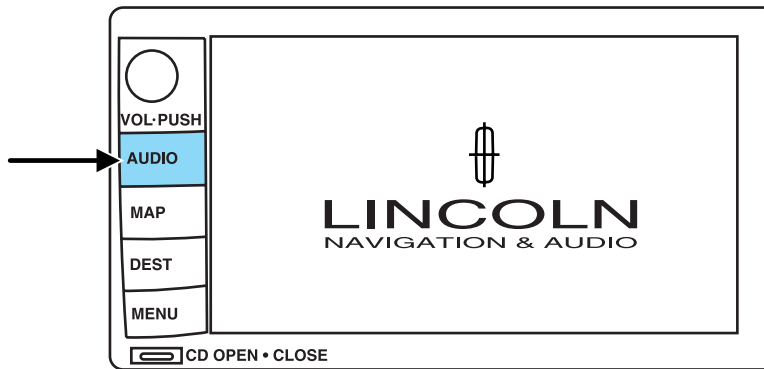

1. Press AUDIO.
2. Press SOUND.

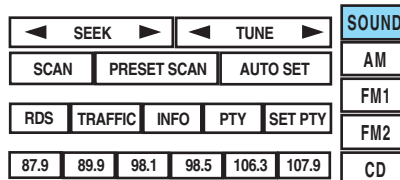

## Entertainment Systems

3. SCV is located in the middle of the screen. Press to turn on.
4. Select setting 1 to 7 or turn off.

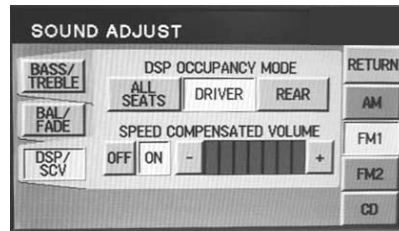

The recommended level for the speed compensated volume is from level 1 through level 3. When activated, level 1 is the minimum setting and level 7 is the maximum setting.

### **AM/FM select**

The AM/FM control works in radio, CD and navigation modes.

### **AM/FM select in radio mode**

Press AM/FM1/FM2 to switch between AM/FM1/FM2 memory preset stations.

### **AM/FM select in CD mode**

Press to stop CD play and begin radio play.

### **AM/FM select in navigation mode**

The radio will continue to play in the background of the navigation screens. To access, press AUDIO then AM/FM1/FM2.

### **Sound functions**

To access settings for Bass, Treble, Balance, Fade, DSP (Digital Signal Programming), SCV (Speed Compensated Volume), and Occupancy modes:

## Entertainment Systems

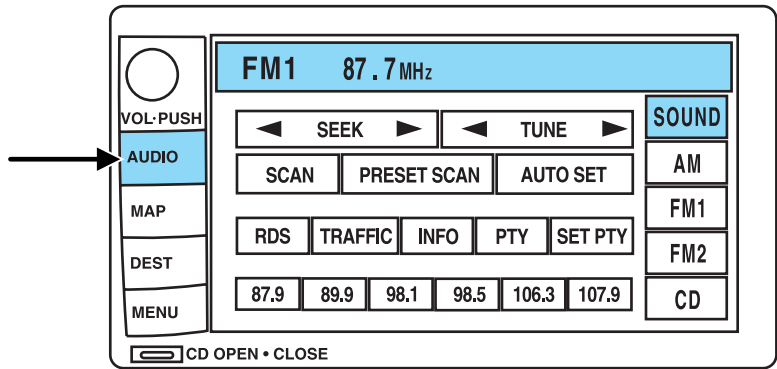

1. Press AUDIO.
2. Press SOUND.
3. Select from Bass/Treb; Bal/Fade; DSP/SCV.
4. Press +/- to increase/decrease the levels.

**Bass** : Allows you to increase or decrease the audio system's bass output.

**Treble** : Allows you to raise or lower the audio system's treble output.

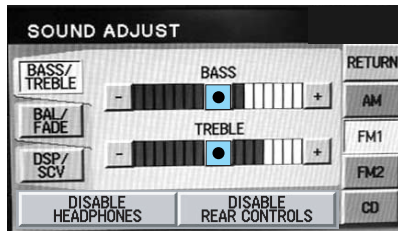

**Fade** : Allows you to adjust sound between the front and rear speakers.

**Balance** : Allows you to adjust the sound distribution between the right and left speakers.

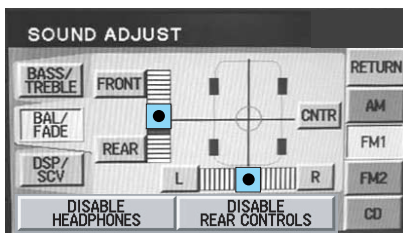

## Entertainment Systems

**SCV** (Speed Compensated Volume) Automatically compensates for road wind and noise. Refer to *Speed compensated volume* earlier in this chapter.

**DSP Occupancy mode** :Use to optimize the sound based upon the occupants in the vehicle. Select from ALL SEATS, REAR SEATS or DRIVER SEAT.



If your vehicle is equipped with rear seat controls, DISABLE HEADPHONES and DISABLE REAR CONTROLS will appear as options at the bottom of the screen. These controls allow you to turn off the headphones and the rear controls for the rear seat passengers. Press the appropriate button to turn the headphones or rear controls off. The button will highlight when the function is disabled. When the button is not highlighted, the function is on (headphones and rear seat controls are operating and able to be controlled by the rear seat passengers.)

### Setting memory preset stations

The radio is equipped with six station memory preset controls. These controls can be used to select up to six preset AM stations and twelve FM stations (six in FM1 and six in FM2).

1. Select the frequency band with the AM/FM1/FM2 touch controls.
2. Select a station.
3. Press and hold a memory preset until the sound returns. The frequency will appear in the preset.

### Seek

- Press ► / ◀ to find the next listenable station up/down the frequency band.
- Press ► / ◀ to advance to the next/previous track on a CD.

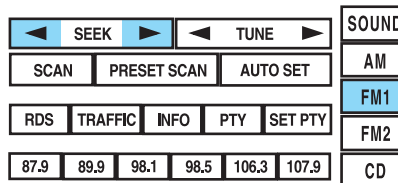



## Entertainment Systems

### Tune adjust

Press TUNE to manually move down/up (◀/▶) the frequency band.

In CD mode, press TRACK to select the previous/next (◀/▶).

◀ SEEK ▶	◀ TUNE ▶	SOUND				
SCAN	PRESET SCAN	AM				
RDS	TRAFFIC	INFO	PTY	SET PTY	FM1	
87.9	89.9	98.1	98.5	106.3	107.9	FM2
						CD

### Autoset memory preset

Autoset allows you to set strong radio stations without losing your original manually set preset stations. This feature is helpful on trips when you travel between cities with different radio stations.

#### Starting autoset memory preset

1. Select a frequency band using AM/FM1/FM2.

◀ SEEK ▶	◀ TUNE ▶	SOUND				
SCAN	PRESET SCAN	AM				
RDS	TRAFFIC	INFO	PTY	SET PTY	FM1	
87.9	89.9	98.1	98.5	106.3	107.9	FM2
						CD

2. Press AUTO SET.

3. When the first six strong stations are filled, the station stored in memory preset control 1 will start playing.

◀ SEEK ▶	◀ TUNE ▶	SOUND				
SCAN	PRESET SCAN	AUTO SET				
RDS	TRAFFIC	INFO	PTY	SET PTY	FM1	
87.9	89.9	98.1	98.5	106.3	107.9	FM2
						CD

If there are less than six strong stations available on the frequency band, the remaining memory preset controls will all store the last strong station available.

To deactivate autoset and return to your audio system's manually set memory stations, press the AUTO SET again.

## Entertainment Systems

### Scan

Press SCAN for a brief sampling of all listenable stations and CD tracks. Press again to disable and remain on the current selection.

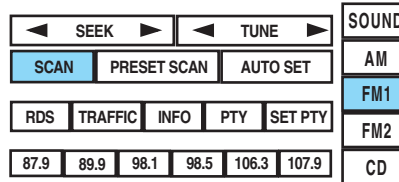

### Preset scan

Press PRESET SCAN to scan the stations stored in the memory presets.

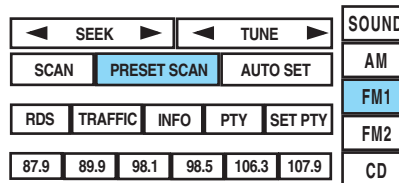

### Radio data system (RDS) feature

This feature allows your audio system to receive text information from RDS-equipped FM radio stations such as station call letters, program type, etc. When in FM mode, press RDS to activate/deactivate.

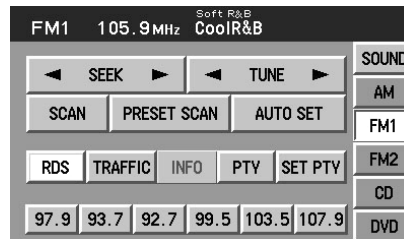

### Traffic function

Select TRAFFIC for traffic information broadcast from certain stations which will automatically interrupt radio or CD playback at a preset volume level.

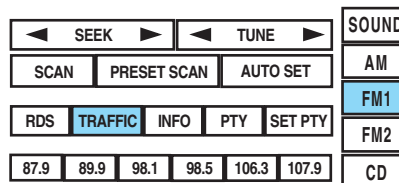

## Entertainment Systems

**Traffic information not available in most U.S. markets.**

### Information feature

Press INFO to view the frequency, call letters and PTY category of the selected FM station.

**Note:** Not all stations support INFO function.

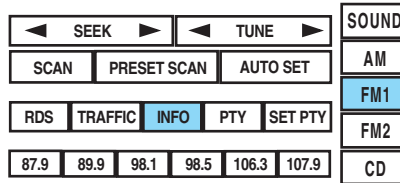

### Program type (PTY)

This feature allows you to search for Radio Data System (RDS) stations selectively by their program type.

Ensure that the RDS function is turned on. Press PTY to turn the feature on/off.

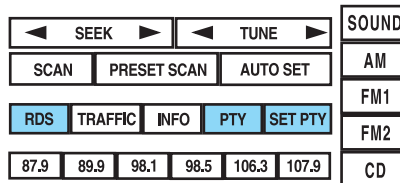

### To set/change PTY:

Ensure that the RDS function is turned on. Press SET PTY to select from the following program types:

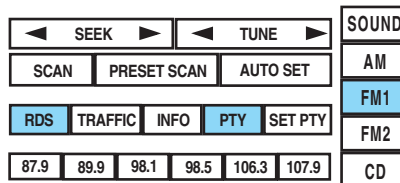

- All
- Classical
- Country
- Information
- Jazz
- Religious
- Rock
- Soft
- Top 40

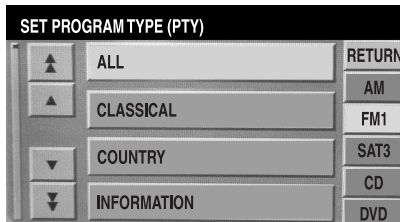

## Entertainment Systems

Once PTY has been programmed, press SEEK (▶ / ◀) or SCAN to initiate a search up or down the frequency. Preset scan and Autoset also initiate PTY searches. The search will stop when the desired program type has been reached. If no program type is found, a message will display.

**Note:** Not all stations support PTY information.

### **Satellite ready capability (if equipped)**

Your Lincoln navigation system may be equipped with Satellite ready capability. The kit to enable Satellite reception is available through your Lincoln dealer. Detailed Satellite instructions are included with the dealer installed kit.

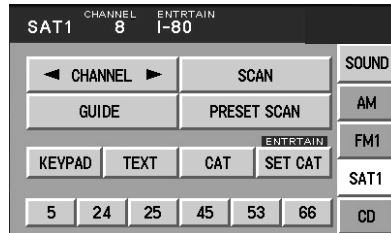

### **CD mode**

**CD units are designed to play commercially pressed 12 cm (4.75 in) audio compact discs only. Due to technical incompatibility, certain recordable and re-recordable compact discs may not function correctly when used in Ford CD players. Irregular shaped CDs, CDs with a scratch protection film attached, and CDs with homemade paper (adhesive) labels should not be inserted into the CD player. The label may peel and cause the CD to become jammed. It is recommended that homemade CDs be identified with permanent felt tip marker rather than adhesive labels. Ball point pens may damage CDs. Please contact your dealer for further information.**

## Entertainment Systems

### Playing a previously loaded CD:

To begin CD play (if a CD is already loaded), press AUDIO hard button and then CD.

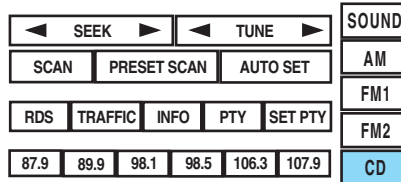

Press CD. CD play will begin where it stopped last.

### Loading a CD:

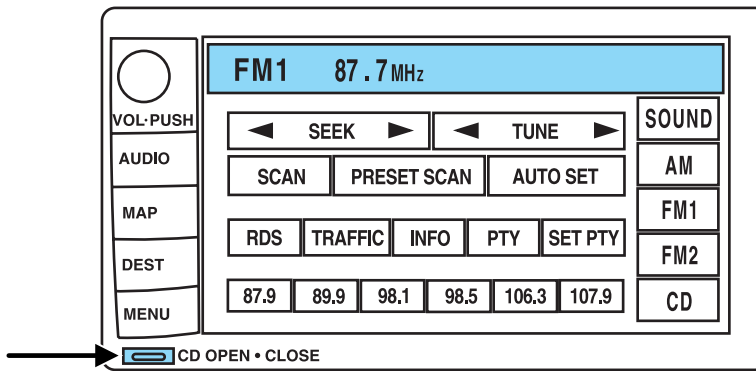
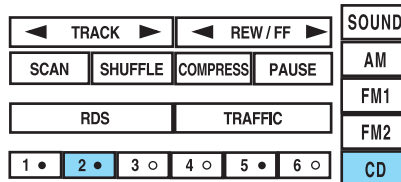

1. Press CD OPEN CLOSE on the bezel.

## Entertainment Systems

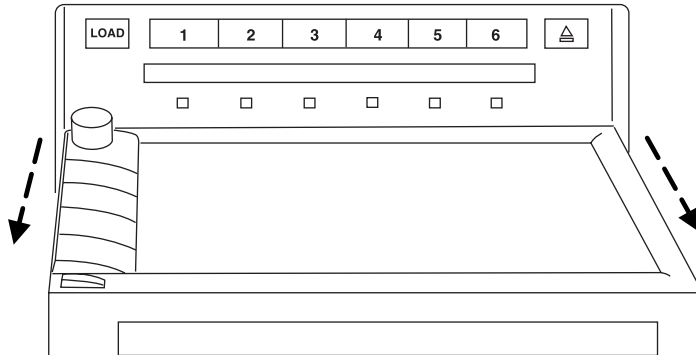

2. The navigation screen will fold down, allowing you access to the in-dash six CD system.
3. Press LOAD and the desired CD slot number. The indicator light will blink slowly at first, then quickly, signaling the system is ready.
4. Insert a disc.
5. **To load more than one disc**, press and hold LOAD. This will initiate autoload and will allow you to load all open CD slots. After an allotted time, the screen will close automatically or you may press CD OPEN CLOSE on the bezel again.
6. Once the screen closes, the system will start playing the last CD loaded.

### Track

Press ► / ◀ to advance to the next/previous track.

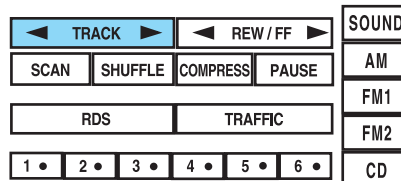

## Entertainment Systems

### Rewind/fast forward in CD mode

Press to reverse or advance (◀ / ▶) in the current CD track.

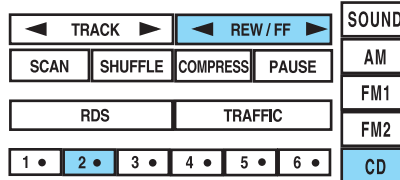

### Scan feature in CD mode

Press SCAN to hear a brief sampling of all tracks on the current CD. Press again to disengage and remain with the current track.

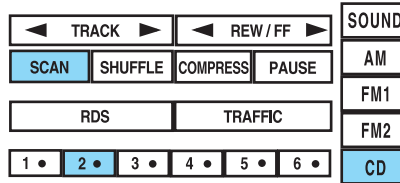

### Shuffle feature in CD mode

When in CD (or CDDJ mode), press SHUFFLE to engage the shuffle feature. Press to select from shuffling between tracks (SHUFFLE TRACK) on the current CD or between all tracks on all CDs (SHUFFLE DISC). All tracks will be played in random order. Press again to disengage (SHUFFLE OFF).

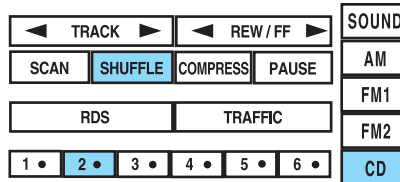

### Compression feature

The compression feature works in CD mode and boosts more quiet music and lowers louder music to minimize the need for volume adjustments.

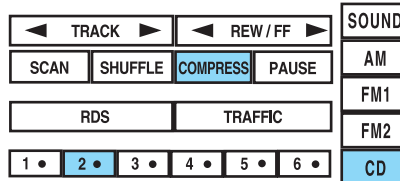

When in CD or CDDJ mode, press COMPRESS to engage or disengage the compression feature.

## Entertainment Systems

### Pause

In CD mode, press PAUSE to pause the current track. Press again to continue playing.

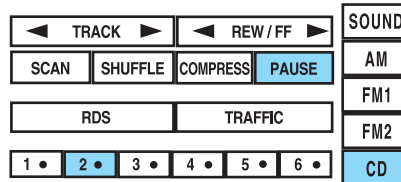

### Map mode

#### Map display information

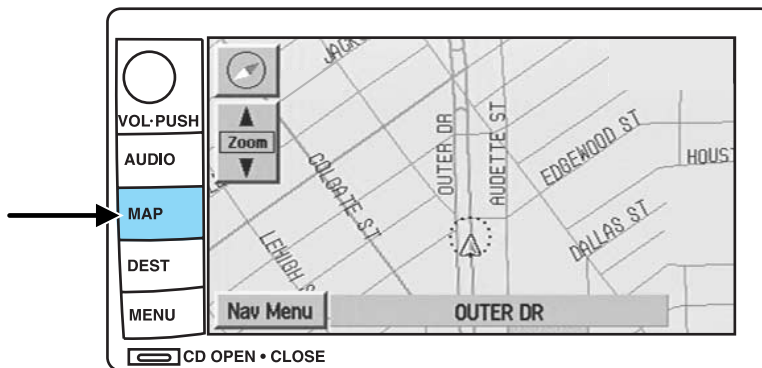

To access the map display, press MAP on the bezel.

Once pressed, the current map display will appear on the screen showing the current vehicle location.



#### Zoom control

When 'Zoom' is pressed, the scale indicator is shown on the screen. The scale markings are: 1/32, 1/16, 1/4, 1/8, 1/2, 1, 2, 4, 8, 16, 32, 64, 128 miles. The control can be used in a number of ways:

- Touch and hold one of the arrow buttons for the map to be displayed again at each zoom level.



## Entertainment Systems

- Touch one of the arrow buttons repeatedly for the map to be displayed again at the final zoom level.
- Touch one of the segments of the scale indicator for the map to be displayed at the selected zoom level.

### **Additional map function buttons**

To initiate the display of additional map function buttons, tap the map anywhere on the screen or press the MAP hard key. These additional features will disappear from the screen within five seconds unless pressed.

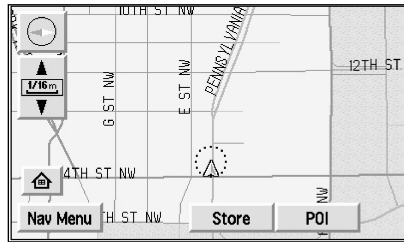

- **STORE** - stores current vehicle location as a memory point. Refer to *Memory Points* for further information.
- **POI** (Point of Interest)- brings up the Quick POI menu which allows the user to perform two functions:
  - Display POI icons on the map for one category.
  - Select local map area POIs as destinations or waypoints. The list of local area POIs can be sorted by distance, name, or icon. Refer to *Points of Interest* for further information.

If home has been previously programmed in the “Nav Menu”, the home icon (house) will appear on the screen and is able to be selected as a destination.

To delete POI icons from the map, touch the map again and press the POI off button.

## Entertainment Systems

### **Route preferences**

After entering a destination, the Route preferences will appear on the screen showing what is currently selected. You may choose to activate/deactivate selections which the system will factor in when calculating your route. Those options are:

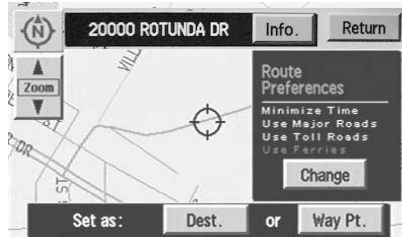

- Minimize Time/Distance
- Use Major Roads
- Use Toll Roads
- Use Ferries

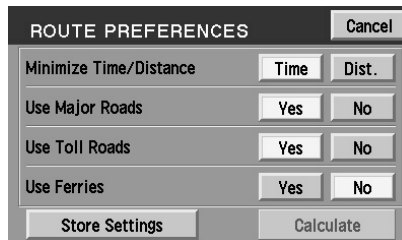

### **Information function**

INFO will appear on the screen when you have calculated a destination. Press INFO for more information about the current destination, if available.

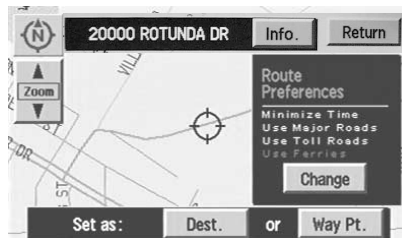

## Entertainment Systems

You will be able to view the information (if available) as well as choose to store the destination as a memory point by pressing OK.

PREVIOUS DESTINATION		Return
Store as memory point		OK
Name	: MILITARY ST, DEARBORN, MI	
Address	: MILITARY ST	
City	: DEARBORN, MI	

### Screen symbols

**Navigation symbol** — Indicates the current vehicle position and points to the direction in which the vehicle is currently traveling.



**Destination symbol** — Indicates the current route destination.

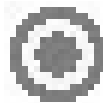

**Next turn symbol** — Shows the next maneuver that will need to be taken on the current route.



**North up button** — Indicates that the map is displayed with north to the top of the screen. Press to toggle between “North up” and “Heading up” map display states.



**Heading up button** — Indicates that the map is displayed with the vehicle heading to the top of the screen. The position of the pointer indicates the direction of north on the map. Press to toggle between “North up” and “Heading up” map display states.



## Entertainment Systems

**Avoid areas or points** — The “X” symbol indicates a point. to be avoided in route calculations.



If the avoid point is enlarged to an avoid area, it will appear on the screen as a shaded box.



**Way point symbol** — Indicates the location of a way point (locations you wish to visit in route to your ultimate destination) on the map.



**Home position symbol** — Indicates the location on the map, currently stored as the home position.



**Stored location symbol** — Indicates the location of a memory point. This is the default symbol used when the point is stored. (If desired, an icon of your own choice can be selected from the 15 icons available.) Refer to *Choosing from the icon list*.



**GPS symbol**— Indicates that insufficient GPS satellite signals are being received for accurate map positioning. The symbol is not displayed under normal operation.



**Speaker icon symbol**— Press to turn voice guidance on/off.



### **Navigation menu**

To access the Navigation Menu, press NAV MENU at the bottom of the map screen.



## Entertainment Systems

Once pressed, the Navigation Menu will display showing the following options:

- Route Options/Preferences
- Navigation Set Up
- Display Options
- Stored Locations
- On Route Scroll
- Voice Guidance/Volume



Depending upon whether or not a route is active will determine if route options/route preferences is contained on the Navigation Menu.

### **Route options (destination entered)**

Once in navigation mode and a route is currently active, press “Chng. route” to access the ROUTE OPTIONS screen. Choose from the following selections:

- **Detour:** Press to select a detour around the current route. Refer to *Detour options* later in this chapter for further information.
- **Route Preferences:** When creating a destination, select from: Minimize Time/Distance, Use Major Roads, Use Toll Roads, Use Ferries.
- **Display Whole Route:** Will enter MAP mode and display your entire chosen route.



**Note:** Route preference appears on the Nav menu when no destination is entered.



While driving under route guidance, only follow an instruction when it is safe to do so as the system cannot be aware of changing conditions. Use voice guidance as much as possible, and only view the display when driving conditions permit.

## Entertainment Systems



Ensure that you follow highway code restrictions and do not take any risks. For example, if you are unable to make a U-turn, continue on your journey. The navigation system will recalculate your route to get you back to an appropriate road to your destination.

### Navigation set up

The Navigation Set up screen will allow you to make adjustments to the navigation displays.

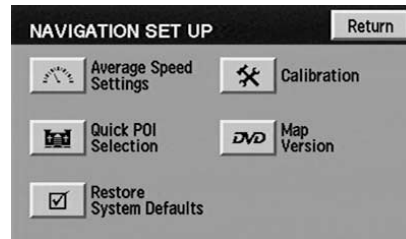

### Average speed settings

Allows you to set approximate speeds you drive. These speeds enable the navigation system to aid in calculating timing for routes.

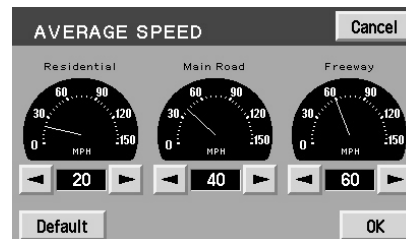

### Quick POI (Point of Interest)

Allows you to change the Quick POI menu settings. Select the desired Quick POI (Gas, ATM, etc.) and then press 'List Categories' for further categories, or 'Map Area POIs' to show the desired POIs on your current map.

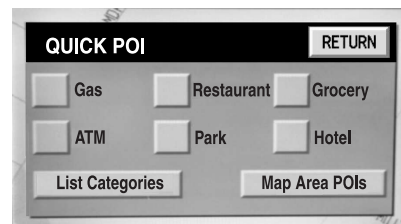

## Entertainment Systems

### **Restore system defaults**

Resets all system user-selectable options to the default (automatic) values (i.e. guidance, voice, search area and route preferences).

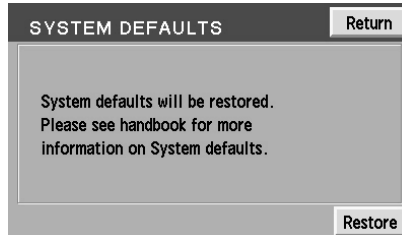

### **Calibration**

This feature is helpful if the car has been towed, or if you notice it is not registering at the correct vehicle location on the map.

Press "Position" to reposition the vehicle location. Press the screen to scroll the map to the desired location and press OK to confirm.

Press "Distance" to calibrate by distance and improve the navigation accuracy. It is recommended to activate this function after every tire replacement. When the button is highlighted, calibration is in process and will turn off automatically when complete.

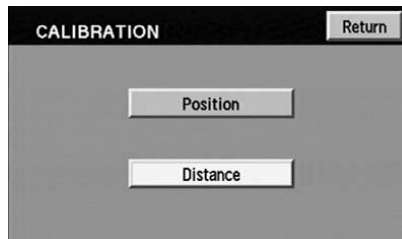

### **DVD map version**

Displays the version of the inserted navigation DVD. Refer to *Ordering additional map DVDs* for further information.

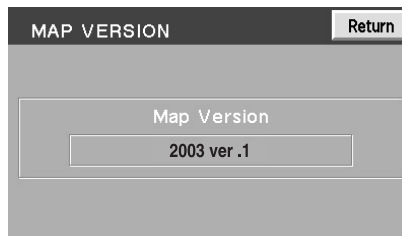

## Entertainment Systems

### Display Options

The Display Options screen will allow you make adjustments to the navigation display screen. You can choose from:

- Map Mode (Dual or Full)
- Guidance Mode (Arrows or Turn list)
- Guidance Display (On or Off)
- Time to destination (Show or Hide)

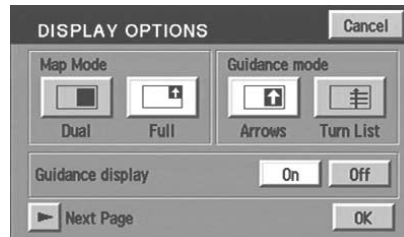

### Stored locations

The Stored locations screen will allow you to choose from destinations that have been saved into the navigation system.

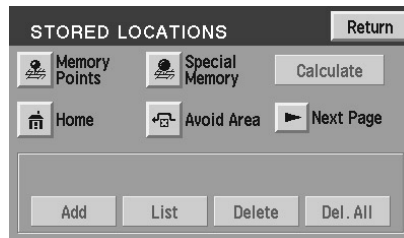



## Entertainment Systems

In this screen, you can select from Memory Points, Special Memory Points, Home, Avoid Area, Destination and Way Point, or Previous Destination. Please refer to the *Destination menu* section for a complete description of the functions.

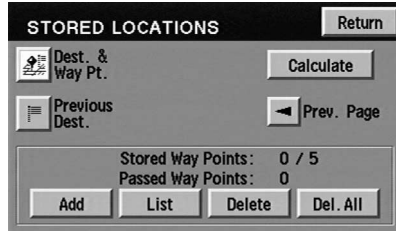

### ***On route scroll***

The system automatically scrolls through the entire planned navigation route either forwards or backwards. To activate, press the arrow buttons at the bottom left of the map screen.

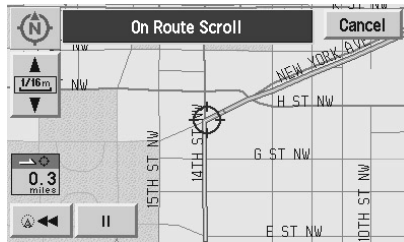

## Entertainment Systems

### **Voice guidance/volume**

Allows you to turn the voice guidance option on/off and to determine the volume level of the guidance voice prompts. To adjust:

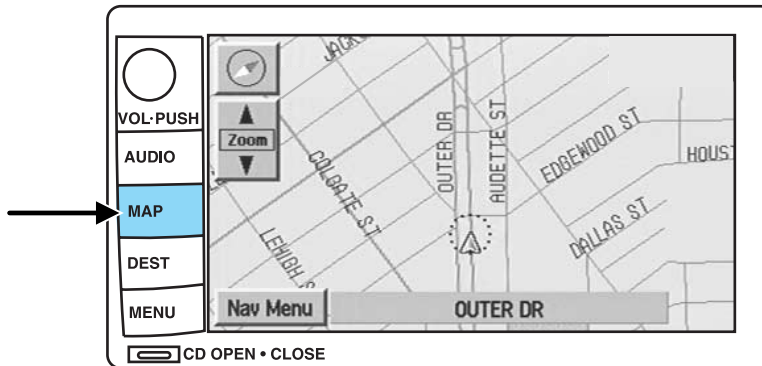

1. Press the MAP hard key.
2. Press "Nav Menu" at the bottom left hand corner of the screen.
3. Press the speaker icon to turn the voice guidance option on/off. Press the desired number to select the volume level for the voice prompts.



## Entertainment Systems

### Home

To set home for the first time:

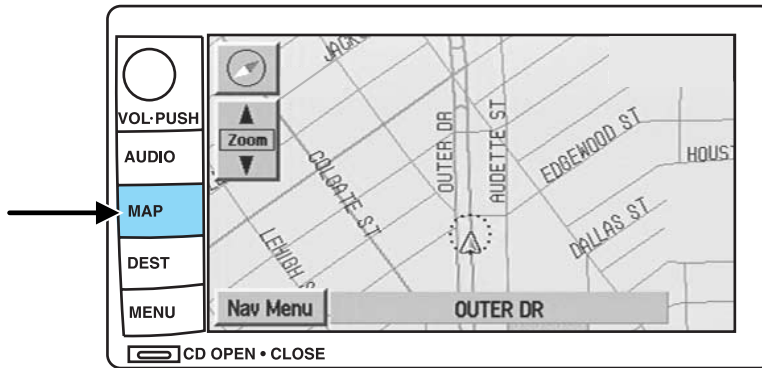

1. Press MAP.
2. Press “Nav. Menu”.
3. Press “Stored Locations”.



4. Press “Home”.
5. Press “Add”.



## Entertainment Systems

6. Select the desired menu item you wish to set as Home (Address, Memory Point, Point of Interest, Previous Destination).

7. Enter the required details.

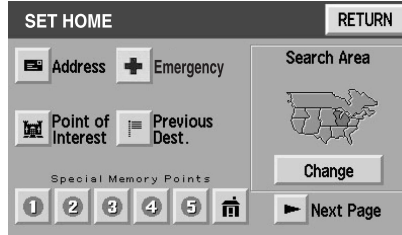

8. Press OK to set the home position.

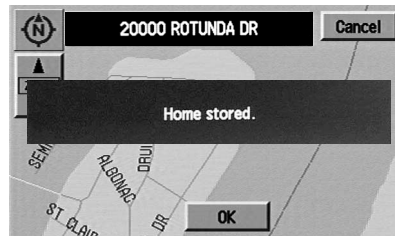

To view home, press the home icon (house) on the Destination Entry screen.



# Entertainment Systems

To view the set home position

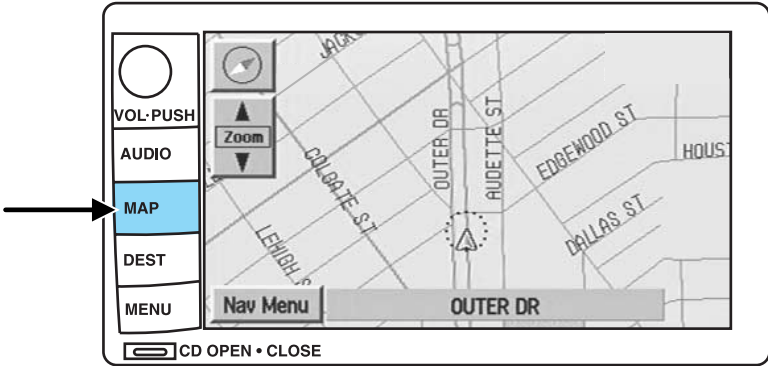

- 1. Press MAP.
- 2. Press “Nav. Menu”.
- 3. Press “Stored Locations”.

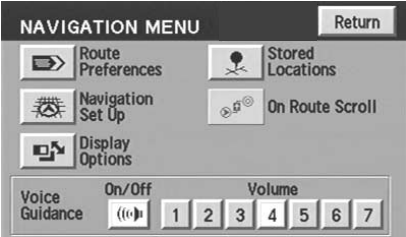

- 4. Press “Home”.
- 5. Press “List”.

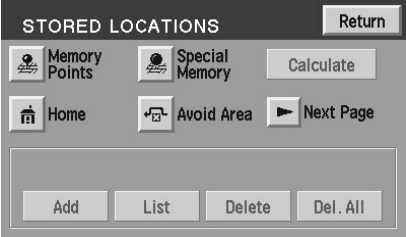

## Entertainment Systems

### Deleting a home location

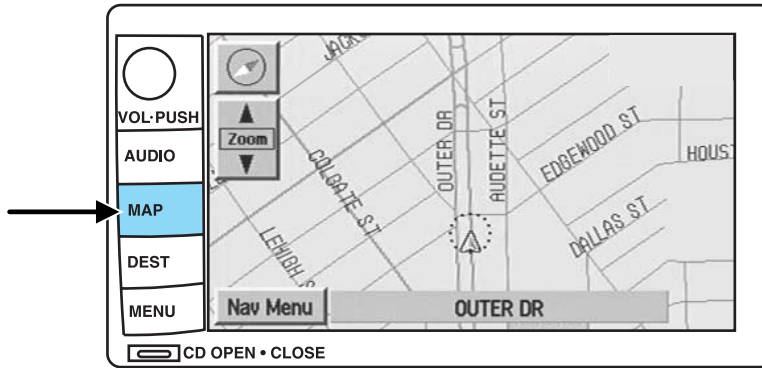

1. Press MAP.
2. Press “Nav. Menu”.
3. Press “Stored Locations”.



4. Press “Home”.
5. Press “Delete”.



## Entertainment Systems

6. Press YES to confirm.



### **Special memory points**

There are five possible special memory points that you can set.



**To set a memory point:**

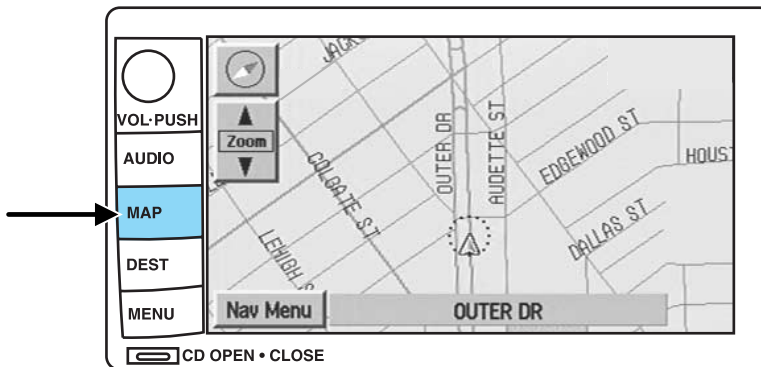

1. Press the MAP hard key.
2. Press "Nav. Menu".

## Entertainment Systems

3. Press “Stored Locations”.



4. Press “Special Memory”.

5. Press “Add” and select a position.

6. Select point 1–5.

7. Input a destination.

8. Press OK.

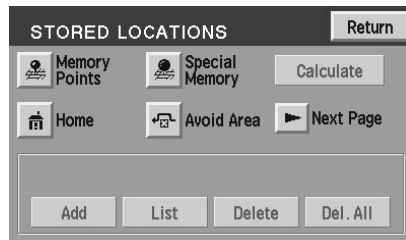

Once all five special memory points are entered, the “Add” control will read as “Full”. You must delete points before more can be added.



## Entertainment Systems

To delete a memory point:

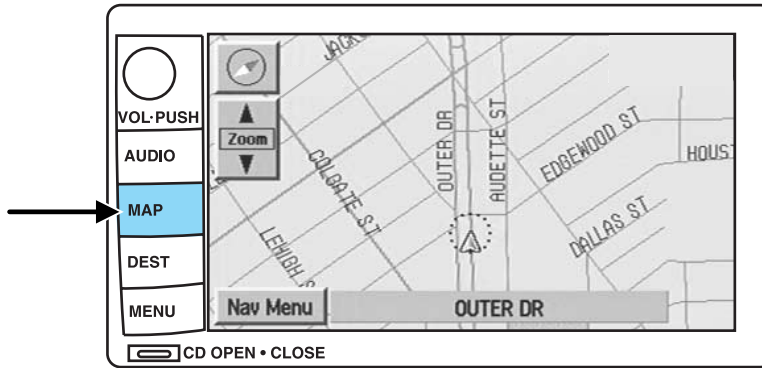

1. Press the MAP hard key.
2. Press “Nav. Menu”.
3. Press “Stored Locations”.



4. Press “Special Memory”.
5. Press “Delete”. The list will display.
6. Select the special memory point to delete.
7. Press “Del. all” to delete all entered special memory points.
8. Press “Yes” to confirm.



## Entertainment Systems

### **Detour options**

You may engage the detour option once a route has already been calculated by the system. To access the detour option:

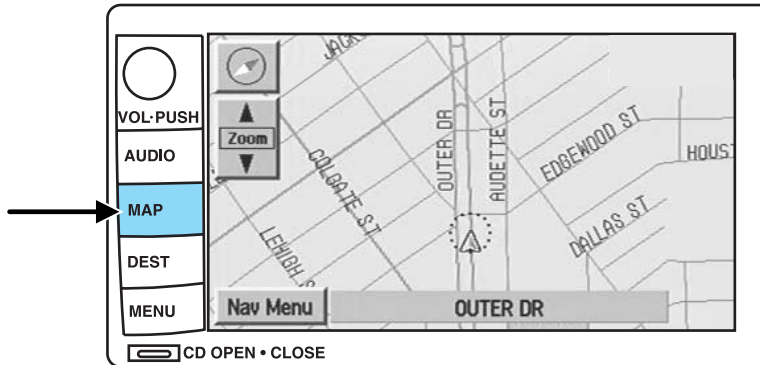

1. Press the MAP hard key
2. Press “Chg. Route”.

Press DETOUR to activate. Use the soft controls to select and enter the number of miles you want to deviate off of the current road.

Press DETOUR to confirm the selection and to activate the detour around the specified areas.

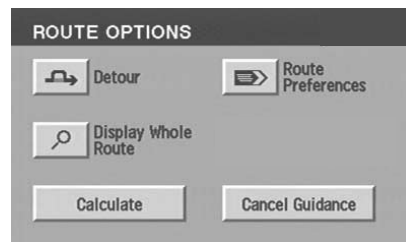

## Entertainment Systems

Press NEW ROUTE if you would like the system to plan a different route. The system may calculate an entirely new route, depending on what is available.

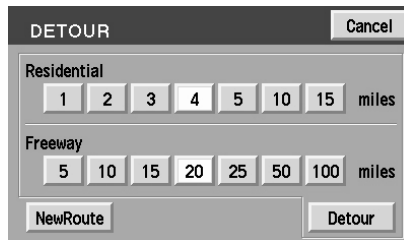

### **Route interruptions**

In the course of your destination, you may decide to temporarily leave your planned route for gas, food, etc. If you turn off the ignition, the option to continue the route guidance will be displayed when the ignition is turned on again. The route can be accessed once again after you press "Agree" on the warning screen.

### **Route alterations or cancellations**

To cancel or change your current route from the map, press DEST. You may then select from Detour, Display whole route, Route preferences, Destination Entry, Calculate or Cancel Guidance.

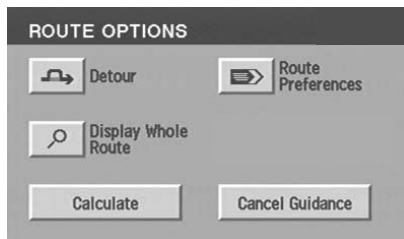

### **Avoiding an area while under guidance**

For one reason or another, you may choose to avoid a certain area while in route to your destination. To select the area to avoid:

- From the MAP screen, press Nav Menu.
- Select Route Options, then Display Whole Route
- Press Turn List

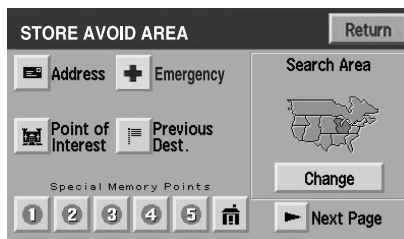

## Entertainment Systems

- Press Avoid next to the street to be avoided
- Choose OK to confirm
- Press Reroute to activate

The new area is added to the list of stored avoid areas.

**Note:** In some circumstances, it may not be possible to avoid all selected areas.

### **Listing areas to avoid**

You can list all areas noted as “avoid”.

- Press “Nav Menu”.
- Press “Stored locations”.
- Press “Avoid area”.
- Press LIST to view all previously stored selections.
- Select the desired one. The map screen will be displayed, showing the location and address of the selected area.

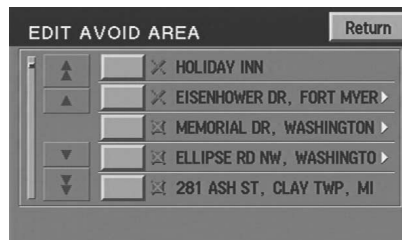

Press Enlarge or Reduce to adjust the size of the visible area. Scroll the map as required.

### **Deleting areas to avoid**

To delete a selection from the “Avoid area” list:

- From the stored locations menu, select “Avoid area”.
- Press DELETE
- Select the desired area to be deleted.
- Press DEL. ALL to delete all stored areas.
- Press YES to confirm.

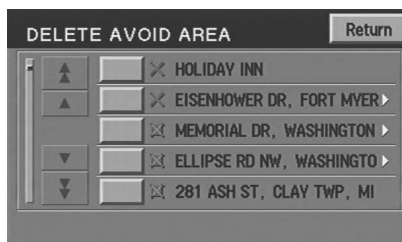

## Entertainment Systems

### Destination menu

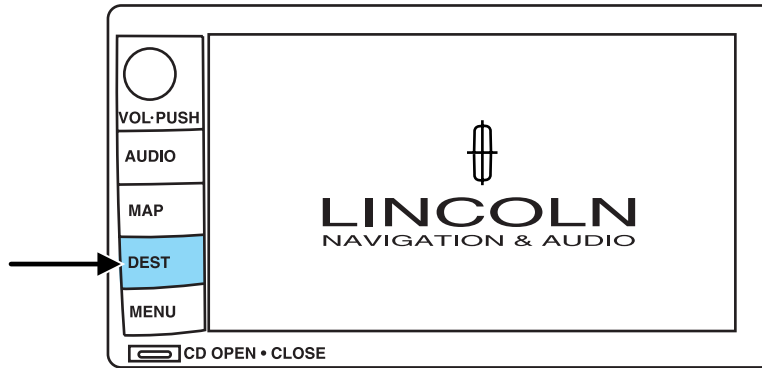

Press DEST on the main bezel to access the navigation mode.

#### **Initial map display**

After pressing AGREE to the initial WARNING screen, you will move into the initial map screen which shows the current vehicle location. Pressing the globe icon will take you to the user settings — audible feedback, navigation units, language and clock (if equipped).

**Note:** There may be a slight time delay between the soft key and the hard key functions.



## Entertainment Systems

### Route options

Once in navigation mode and a route is currently active, press the DEST hard key. The ROUTE OPTIONS screen will appear and allow you to choose from the following selections:



- **Detour** — Press to select a detour around the current route.
- **Route Preferences** — When creating a destination, select from: Minimize Time/Distance, Use Major Roads, Use Toll Roads, Use Ferries.
- **Display Whole Route:** Will enter MAP mode and display your entire chosen route.
- **Destination Entry:** Allows you to enter a new destination or select from entries in: Address book, Points of Interest or Previous Destinations.

 While driving under route guidance, only follow an instruction when it is safe to do so as the system cannot be aware of changing conditions. Use voice guidance as much as possible, and only view the display when driving conditions permit.

 Ensure that you follow highway code restrictions and do not take any risks. For example, if you are unable to make a U-turn, continue on your journey. The navigation system will recalculate your route to get you back to an appropriate road to your destination.

## Entertainment Systems

### **Destination entry**

#### **Search area**

The mapped areas covered by your map DVD are reflected in the Search Area map that is displayed on the Destination Entry screen. Your navigation system uses a regional search area. This area is the area from which navigational directions will be used.

To check your area or reset, press CHANGE under the search area listing. The map will open and allow you to select another regional area. Ensure that your search area is correct prior to setting your destination.



#### **Selecting a destination**

Press DEST to set a destination. From this menu, you may select from the following options:

- **Address**— Use to select a destination based on a known street address.
- **Point of Interest**— Use to select a destination that is a point of interest location (i.e., airport, restaurant, hospital).
- **Previous Destination** — Use to select a destination from among the last 20 entered destinations
- **Emergency** — Use to select the Emergency screen which will give you the location of the closest Hospital, Police Station and Dealer.

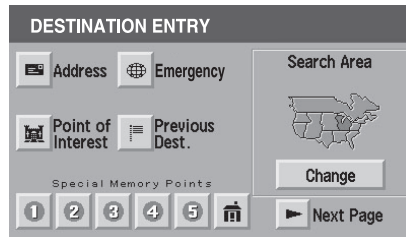

## Entertainment Systems

Press ► 'Next Page' to access more selections:

- **Memory point** — Use to select from a memory point.
- **Freeway exit/entrance** — Use to select a certain freeway exit or entrance.
- **Select from map** — Use to select a place on the map.
- **Special Memory Points** — Use to select a destination from previously stored entries.

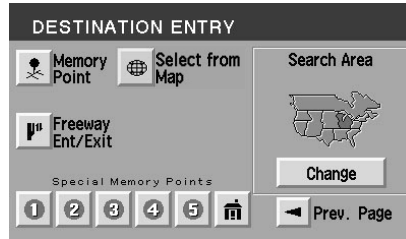

### Address

1. From the destination entry screen, select "Address".

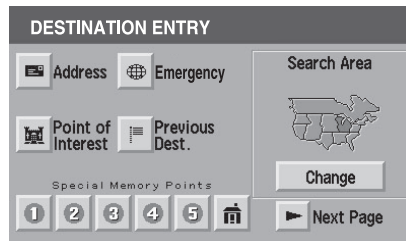

2. Input the house/building number and press OK.

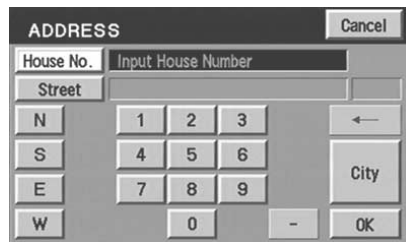



## Entertainment Systems

3. Use the keyboard to type in the street name. When you are typing the street name, the system may bring up possible roads that you can select from. Use the arrows to scroll up or down to select the desired street.

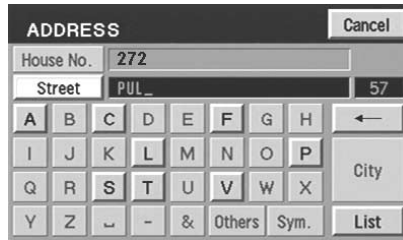

The screenshot shows the ADDRESS screen with a 'Cancel' button in the top right. The 'House No.' field contains '272'. The 'Street' field contains 'PUL...' and a '57' is visible to the right. Below the input fields is a keyboard with letters A through Z, a back arrow, and a 'List' button. The 'City' field is empty.

4. Once the address is entered, the system will pull up some possible city and state matches. If one of those is correct, select it. If not, you may press either “5 near cities” for another listing of five possible cities and states (if available). Or, press “Input City Name”.



The screenshot shows the ADDRESS screen with a 'Return' button in the top right. Below the input fields is a list of five city and state matches: PIONEER VILLAGE, KY; PIONEER TWP, MI; ZEELAND, MI; LANSING, MI; DEARBORN, MI. At the bottom are two buttons: '5 near Cities' and 'Input City Name'.

5. You may use the keyboard to input the desired city.



The screenshot shows the ADDRESS screen with a 'Cancel' button in the top right. The 'City' field contains 'Input City Name' and '9668' is visible to the right. Below the input fields is a keyboard with letters A through Z, a back arrow, and a 'List' button.

## Entertainment Systems

### **Points of interest (POI)**

Select “Point of Interest” from the Destination Entry Menu. In this next menu, you will have the following options:

- **By Name**— Enter POI name on the keyboard. Touch “List” to display the list of matching points of interest. If there are too many matches being listed, try entering the town name first.
- **By Category** — Press “Category”. Scroll down the list to select the category, then sub-category desired. Once you have selected a category, your entry of the POI will be restricted to that category.

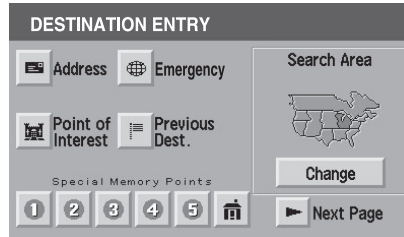

### **Previous destination**

Press “Previous Destination” on the Destination Entry Menu.

1. Select (touch) the desired item from the list of destinations previously reached. The item details will be listed.
2. Confirm destination details.



# Entertainment Systems

## Deleting stored locations

Your navigation system allows you to delete any stored locations (previous destinations, memory points, special memory points, home, avoid areas, destination and way points, etc.) To delete any of these stored locations:

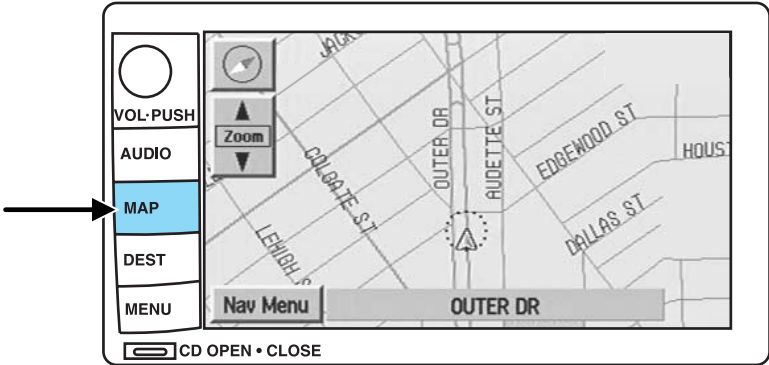

- 1. Press the MAP hard key.
- 2. Press "Nav Menu" in the bottom left hand corner of the screen.
- 3. Press "Stored locations".

Nav Menu

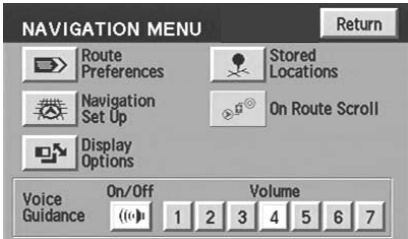

## Entertainment Systems

4. Select the desired item you wish to delete (previous destination, memory point, etc.).
5. Press “Delete” at the bottom of the screen.



6. The list of stored locations will be displayed.
7. Select (touch) the entry to be deleted. The item details will be listed.
8. Press YES to confirm the deletion.



9. Press DELETE ALL to delete all stored locations.



### Emergency

Your navigation system is equipped with a separate Emergency screen. To access the Emergency screen, press “Emergency”.

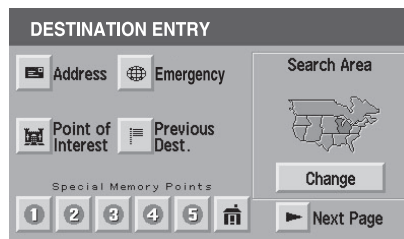

## Entertainment Systems

This screen will list the closest police station, hospital and dealer to your current location.

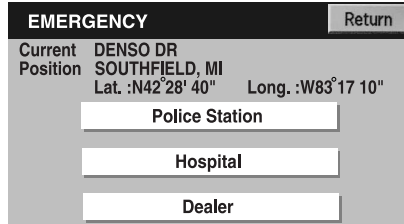

### Memory point

Your navigation system allows you to go to special destinations you may wish to again visit. To view any of these “memory points” without a route calculated:

1. Press the DEST hard control.
2. Press “▶ Next page” on the Destination Entry screen.
3. Select “Memory Point”.
4. Select the desired item.
5. Confirm the details.
6. Press “Destination” to calculate a route to that memory point.

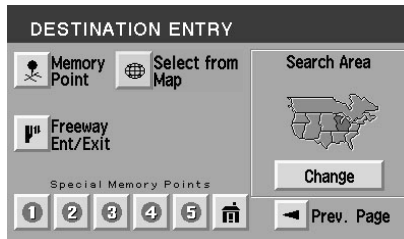

**Note:** The list can be sorted by date, name or icon by pressing the appropriate button.

### Adding a memory point

You may add more memory points to be stored in the system.

1. With the map displayed, touch your finger to the screen to scroll to the desired location. When you reach the desired location, remove your finger from the screen and the map will stop scrolling. STORE will appear on the screen.
2. Press STORE to add the location to the memory point list.

You may also add a memory point via the Navigation menu.

## Entertainment Systems

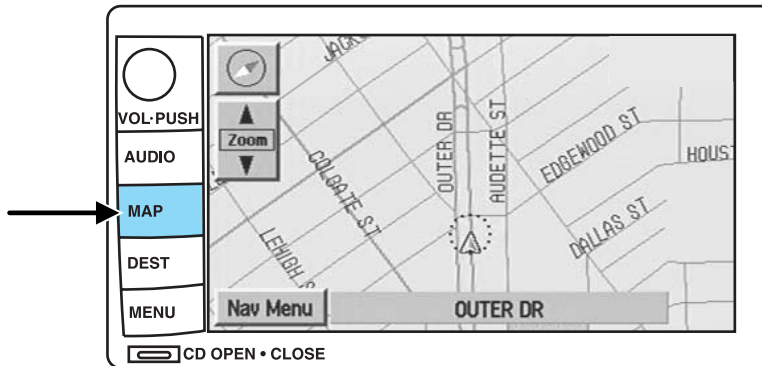

1. Press the MAP hard key.
2. Press “Nav Menu” in the bottom left hand corner of the screen.

Nav Menu

3. Press “Stored locations”.



4. Select “Memory Point”.
5. Press “Add” at the bottom of the screen.
6. Select the desired menu item.
7. Enter/select any required details. The new point will be added to the stored list of memory points.
8. Press OK. The new point will be added to the list of stored memory points.



94

## Entertainment Systems

To give the new memory point a name:

1. Select it from the list.
2. Press NAME.
3. Enter the desired name.

### **Accessing memory point lists**

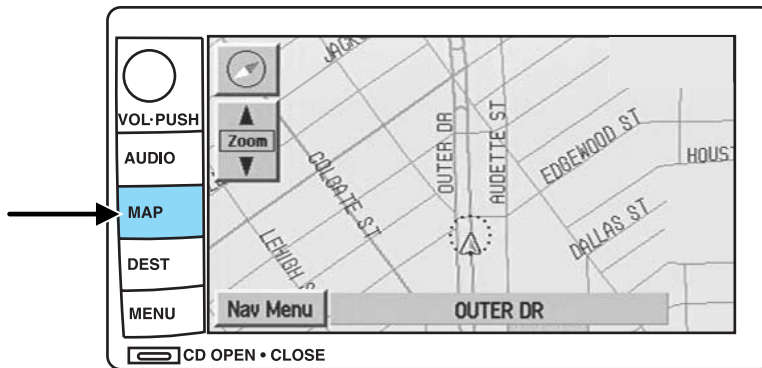

1. Press the MAP hard key.
2. Press “Nav Menu” in the bottom left hand corner of the screen.
3. Press “Stored locations”.



## Entertainment Systems

4. Press “Memory Point”.
5. Press LIST



6. Select the desired entry to view its location details.

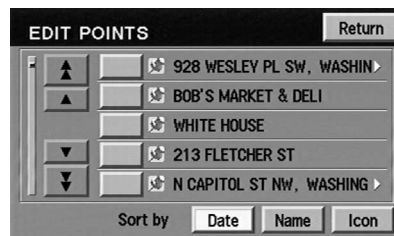

### **Sorting memory point lists**

1. Access the desired list.
2. Press the button to sort the list as desired (i.e. date, name, or icon).

When sorted by distance, the points are ordered by distance from the current vehicle location. When sorting by icon, the icons are listed in the order they appear on the icon selection screen.

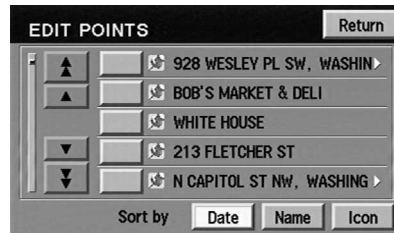



## Entertainment Systems

### Choosing from the icon list

After selecting a location, press ICON to edit. There will be 15 normal and three sound icons displayed. Press the icon you wish to use.

The normal icons will be displayed on the map to indicate the map location identified with that icon. The audible icon will sound a distinctive chime when the vehicle is approaching the memory point associated with that icon.

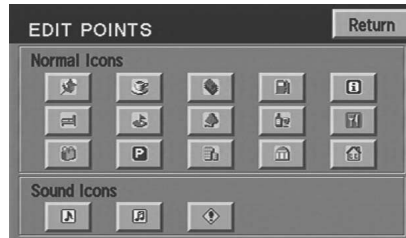

### Deleting a memory point

- In the Memory Point Menu, press DELETE.
- Select the entry to be deleted.
- The system will ask you to confirm deletion. Press YES to confirm.

The screen will briefly show "Memory Point Deleted".

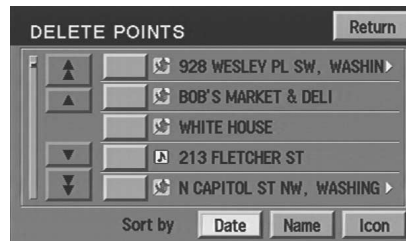

### Deleting all memory points

- In the Memory Point Menu, press DELETE ALL.

**Del. All**

- The system will ask you to confirm deletion. Press YES to confirm.

The screen will briefly show "All Memory Points Deleted".

## Entertainment Systems

### Freeway Entrance/Exit

To set a freeway entrance or exit as a destination:

1. Press the DEST hard key.
2. Press “▶ Next page” to access the second page of the Destination Entry menu.
3. Select “Freeway Entrance/Exit”.

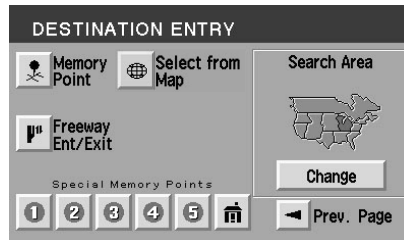

1. **Enter freeway name**— Enter the freeway name using the keyboard. Press “List” to select a freeway from those displayed.

To enter numbers in the freeway name, press “Sym”.



2. **Select entrance/exit**— Press “Entrance” if you wish to join the freeway at this junction. Press “Exit” if you wish to leave the freeway at this junction.

3. **Select Junction**— The screen will display a list of junctions on the freeway. They can be listed either by distance, (from the current vehicle location), by pressing the “Dist” button or alphabetically by pressing the “A-Z” button. Select the desired entrance or exit.

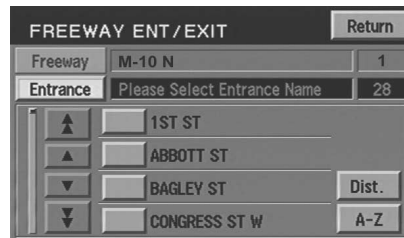

The destination details are displayed for confirmation.

## Entertainment Systems

### ***Destination and way points***

The Store Dest. & Way Point menu is used after a destination or way point has been entered for the first time using the Destination Entry menu. You can store and delete destinations and way points (locations you wish to visit in route to your ultimate destination). You can also select the order in which you visit them.

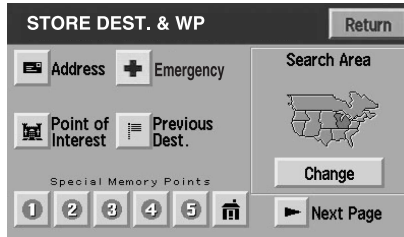

### ***Adding (storing) a destination or way point***

- Once a destination is entered, press ADD to store the location. The Store Dest. & Way Point menu is displayed.
- Select whether you want to store an Address, Point of Interest or Previous Destination.
- Enter the necessary details for the selection.
- If a destination was entered, it will be stored as the current location. If a way point was entered, it will be added to the list of way points.

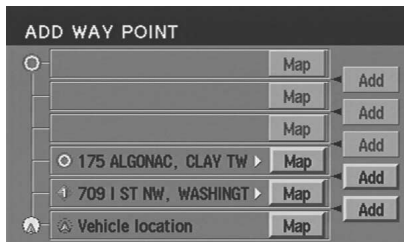

### ***Listing destinations and way points***

Press LIST to display the stored way points and destination (if entered).

The first way point to be visited is at the bottom of the list and the destination is at the top.

You may view the map location of any entry. On the map, location details for the entry are displayed at the top of the screen.

To adjust the position of the way point (or destination), scroll the map as required.

Press OK.

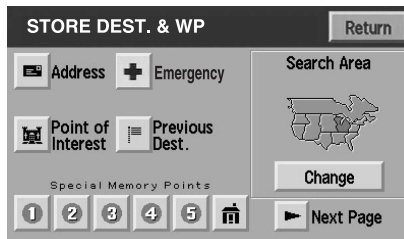

## Entertainment Systems

### **Editing and changing order of way points and destination**

Press “Chg. Order” to change the order in which the way points are visited. The points are listed chronologically from bottom up, the destination being on the top.

Press the MAP button to edit the way point location on the map display.

Press OK to confirm.



### **Deleting way points and destination**

After pressing DELETE, the list of way points and the destination (if entered) is displayed, showing the 'Delete Dest. &Way Pt.' menu.

Select the entry to be deleted. Press YES to confirm.

Press DELETE ALL to delete all way points. Press YES to confirm.



### **Selecting route criteria**

Once you have selected a destination, you may change the routing criteria by pressing “Change” in the route preferences screen. Refer to *Route preferences* for further information.

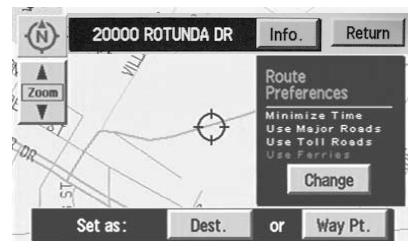

## Entertainment Systems

### **Route calculation**

Once the route criteria is selected, the navigation system automatically calculates the selected destination. The route appears on the display screen and a voice prompt provides instructions.

The system may calculate up to four routes for the desired destination. Press "Next" to scroll through the various planned routes. Press "Start" to confirm the route selection and begin route guidance.

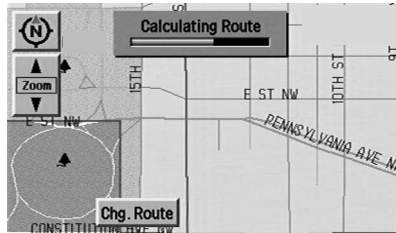

### **Next route**

Your navigation system may map more than one route to the same destination. After the destination has been calculated, it will appear on the map screen. Press NEXT in the upper right hand corner to scroll through other possible routes to the same destination.

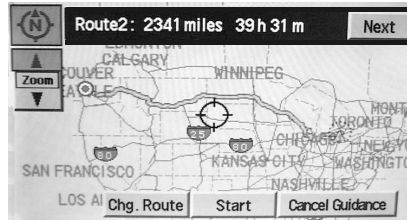

## Entertainment Systems

### Menu mode

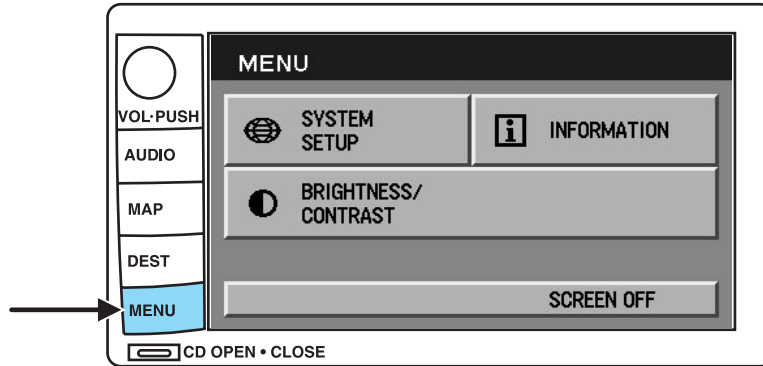

To access menu mode, press the MENU hard control.

Menu mode allows you to access:

- System Set-up
- Information — Gives you the Lincoln Customer Assistance Center information.

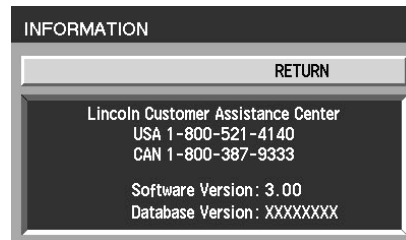

- Brightness/Contrast — Allows you to adjust the brightness and contrast on the screen.

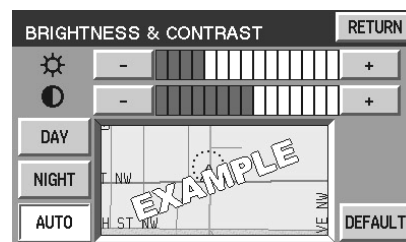

## Entertainment Systems

- Screen off — Allows you to turn off the navigation screen.

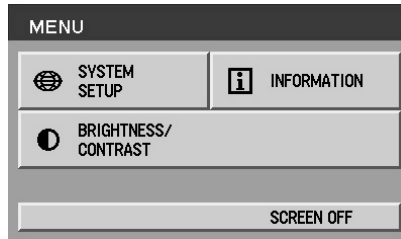

### System setup

The system set up menu contains the following user settings:

- Audible Feedback — Press to activate audible voice navigation commands. Press again to deactivate.
- Navigation Units — Press to toggle between Metric/English units.
- Language — Press to toggle between English, French, or Spanish.

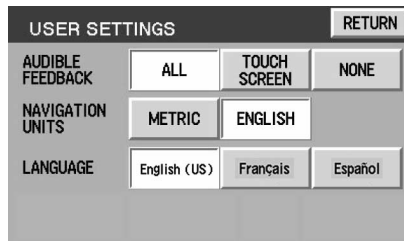

### DVD interaction (if equipped)

Your vehicle may be equipped with a DVD player. Your Lincoln Navigation System (LNS) will interact with your DVD player, providing you access and messages to the status of the system.

- Press AUDIO.
- Press DVD to access the DVD screen.

You may select from different chapters, rewind or fast forward within the current chapter, stop, play or pause the DVD. You may also select DVD AUX mode (which would allow you to plug in and play games), to enable/disable headphones, or to enable/disable rear seat controls. For further information, refer to *Rear seat audio controls (if equipped)* and *Family entertainment DVD system (if equipped)* earlier in this chapter.

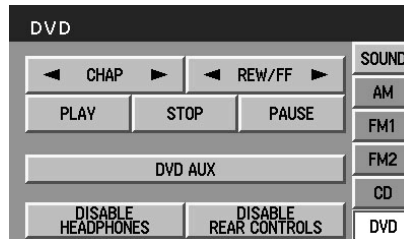

## Entertainment Systems

### General information

#### **Safety information**

**Please read and follow all stated safety precautions. Failure to do so may increase your risk of collision and personal injury. Ford Motor Company shall not be liable for any damages of any type arising from failure to follow these guidelines.**

Do not attempt to service, repair or modify the system. See your Ford or Lincoln Mercury dealer.



The driver must not attempt to operate any detailed operation of the navigation system while the vehicle is in motion. Give full attention to driving and to the road. Pull off the road and park in a safe place before performing detailed operations.

**If the system is used for an extended period of time with the vehicle stationary, ensure that the engine is running to avoid draining the battery.**

Do not apply pressure to the display screen.

The navigation system is not a substitute for your personal judgement.

Route suggestions should not supersede local traffic regulations or safe driving practices.

Do not follow route suggestions if they direct you to perform an unsafe or illegal maneuver, would place you in an unsafe situation, or would route you into an area that you consider unsafe.

Drivers should not rely on screen displays while their vehicle is in motion. Let the voice guide you. If viewing is necessary, pull off the road to a safe location.

Do not use the navigation system to locate emergency services.

For road safety reasons, the driver should program the system only when the vehicle is stationary. Certain functions will therefore not operate while the vehicle is in motion.

The map database DVD does not reflect road detours, closures or construction, road characteristics such as rough road surface, slope or grade, weight or height restrictions, traffic congestion, weather or similar conditions.

To use the system as effectively and safely as possible, obtain an up-to-date map database DVD whenever they become available.

Set the volume level so that you can hear directions clearly.



## Entertainment Systems

Do not disassemble or modify the system as this may lead to damage and void your warranty. If a problem occurs, stop using the system immediately and contact your Ford or Lincoln Dealer.

### **Federal Communication Commission (FCC) Compliance**

Changes or modifications not approved by Ford Lincoln Mercury could void user's authority to operate the equipment. This equipment has been tested and found to comply with the limits for a Class B digital device, pursuant to Part 15 of the FCC Rules. These limits are designed to provide reasonable protection against harmful interference in a residential installation. This equipment generates, uses and can radiate radio frequency energy and, if not installed and used in accordance with the instructions, may cause harmful interference to radio communications.

However, there is no guarantee that interference will not occur in a particular installation. If this equipment does cause harmful interference to radio or television reception, which can be determined by turning the equipment off and on, the user is encouraged to consult the dealer or an experienced radio/TV technician for help.

**The database reflects reality as existing before you received the database and it comprises data and information from government and other sources, which may contain errors and omissions. Accordingly, the database may contain inaccurate or incomplete information due to the passage of time, changing circumstances, and due to the nature of the sources used. The database does not include or reflect information on neighborhood safety, law enforcement, emergency assistance, construction work, road or lane closures, vehicle or speed restrictions, road slope or grade, bridge height, weight or other limits, road or traffic conditions, special events, traffic congestion, or travel time.**

### **Radio reception factors**

There are certain factors that may effect your radio reception.

- **Distance/strength.** The further an FM signal travels, the weaker it is. The listenable range of the average FM station is approximately 40 km (24 miles). This range can be affected by "signal modulation." Signal modulation is a process radio stations use to increase their strength/volume relative to other stations.
- **Terrain.** Hills, mountains and tall buildings between your vehicle's antenna and the radio station signal can cause FM reception problems. Static can be caused on AM stations by power lines, electric fences,

## Entertainment Systems

traffic lights and thunderstorms. Moving away from an interfering structure (out of its “shadow”) returns your reception to normal.

- **Station overload.** Weak signals are sometimes captured by stronger signals when you pass a broadcast tower. A stronger signal may temporarily overtake a weaker signal and play while the weak station frequency is displayed.

### ***Principles of GPS (global positioning system) operation***

Your system directs you based on information derived from global positioning satellites, road maps stored on the DVD, sensors in your vehicle and the desired destination. The system compiles all necessary information to guide you to your selected destination. Space satellites determine the vehicle’s current location and transmit position and time signals to your car.

If the vehicle has been parked for a long period of time, the navigation function may be temporarily unresponsive. The navigation system will operate reliably again once GPS reception is available for a few minutes.

### ***Limited GPS reception***

System performance may be adversely affected if GPS reception is interrupted or interference occurs over a distance of several miles. The following are possible causes for GPS reception being interrupted. If the vehicle is:

- in multi-story parking garages
- in tunnels and under bridges
- inside or in between buildings
- by forests or tree-lined avenues
- in heavy rain showers and thunderstorms
- in valleys and in mountainous regions
- roads under cliffs

Ensure that you do not have any metal objects on the rear parcel shelf. If your windows are tinted, ensure that you use non-metal tinting instead of metal oxide tinting. Both of these factors can interrupt GPS reception.

### ***Cleaning the display***

Do not spray cleaning fluid directly onto the unit. Instead, spray onto a soft cloth and gently wipe the unit. Only recommended products should be used.

- Recommended products- Rubbing alcohol based cleaner (i.e., methyl alcohol) or a damp clean cloth.

## Entertainment Systems

- Not harmful but not recommended- ammonia cleaner, neutral detergent.
- Harmful to system and not recommended- acid cleaner, alkali cleaner, benzene cleaner.

Do not clean any part of the system with benzene, paint thinner or any other solvent.

Do not spill liquids of any kind onto the unit.

### **Loading the map DVD**

- Your navigation DVD unit is located in the front lower center stack area by the passenger's feet (access door).
- Ensure that the vehicle ignition is ON.
- If a DVD is already loaded in the Navigation unit, push the eject button.
- Load the DVD with the printed side up. Do not allow moisture or foreign objects to enter the slot.

The navigation system utilizes a database stored in a special format on a DVD. It is recommended always to use the latest update of this map DVD.

- The navigation system will only work with DVDs specifically intended for your navigation system.
- Always store the map DVDs in their protective cases when not in use.

### **Ordering additional map DVDs**

If you wish to order a replacement or additional map, please call 1-888-NAV-MAPS (1-888-628-6277) or to log onto [www.navtech.com](http://www.navtech.com).

### **Latest map DVDs**

The map content is constantly changing due to new roads, traffic restrictions, etc. . Therefore, it is not always possible to exactly match the DVD map with the current roadways. For best results, always use the latest version of the map DVD. Map information is regularly updated, but all areas are not necessarily covered to the same level of detail. Some areas, in particular private roads, may not be included on the database. To help with accuracy, always use the latest DVD version for navigation.



### **Customer service**

If you need help operating your navigation/audio system, want to report a map database error or want to obtain a map DVD, please call 1 (888) 628-6277 (NAV-MAPS) or log onto [www.navtech.com](http://www.navtech.com).

## Climate Controls

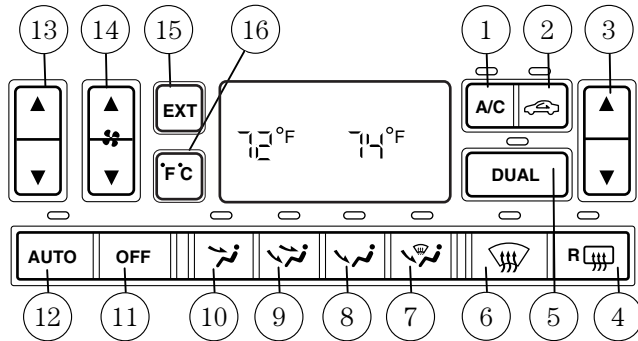
### DUAL ELECTRONIC AUTOMATIC TEMPERATURE CONTROL (DEATC) SYSTEM (IF EQUIPPED)



1. **A/C control:** Uses outside air to cool the vehicle. Press to turn on/off in all modes except  or .



2. **Recirculation control:** Used to manually enable or disable the operation of recirculated air in all modes except Defrost. Cools the vehicle more quickly by recirculating the cabin air instead of using outside air and helps prevent unpleasant outside odors or fumes from entering the vehicle. In automatic operation, the recirculated air operates automatically as necessary to achieve the selected temperature.



3. **Passenger side temperature control:** Controls the temperature on the passenger side of the vehicle when in dual zone mode. To enter dual zone, press the passenger temperature control or DUAL. The passenger temperature will appear in the display.



4. **Rear defrost control:** Removes ice and fog from the rear window. Press to turn on/off.



5. **DUAL** (Single/dual electric temperature control): Allows the driver to have full control of the cabin temperature settings (single zone) or allows the passenger to have



## Climate Controls

control of their individual temperature settings (dual zone control). Press to enable dual zone mode, press again to return to single zone.

6.  : Distributes outside air through the windshield defroster vents.

7.  : Distributes outside air through the windshield defroster vents and floor vents.

8.  : Distributes outside air through the floor vents.

9.  : Distributes outside air through the instrument panel vents and the floor vents.

10.  : Distributes outside air through the instrument panel vents.

11. **OFF:** Outside air is shut out and the fan will not operate.



12. **AUTO:** Press AUTO and then select the desired temperature. The system will automatically determine fan speed, airflow location and outside or recirculated air to heat or cool the vehicle to achieve the selected temperature.



13. **Driver's side temperature control:** Controls the temperature for both driver and passenger. Controls only the driver's side of the vehicle if operating in DUAL mode.



14. **Fan Speed:** Used to manually enable or disable the fan speed.



15. **EXT:** Displays the outside air temperature. It will remain displayed until the EXT control is pressed again. The external temperature will be most accurate when the vehicle has been moving for a period of time.



16. **Temperature conversion:** Press to toggle between Fahrenheit and Celsius temperature on the DEATC display only. The set point temperatures in Celsius will be displayed in half-degree increments.



## Climate Controls

**Manual override controls:** Allows you to manually determine where airflow is directed. To return to fully automatic control, press AUTO.



### OPERATING TIPS

- To reduce fog build up on the windshield during humid weather, place the air flow selector in the  position.
- To reduce humidity build up inside the vehicle: do not drive with the air flow selector in the OFF or (in cold weather) MAX A/C position.
- Under normal weather conditions, do not leave the air flow selector in MAX A/C or OFF when the vehicle is parked. This allows the vehicle to “breathe” using the outside air inlet vents.
- Do not put objects under the front seats that will interfere with the airflow to the back seats.
- Remove any snow, ice or leaves from the air intake area at the base of the windshield.

To aid in side window defogging/demisting in cold weather:

1. Select .
2. Select A/C.
3. Modulate the temperature control to maintain comfort.
4. Set the fan speed to the highest setting.
5. Direct the outer instrument panel vents towards the side windows.

To increase airflow to the outer instrument panel vents, close the vents located in the middle of the instrument panel.



Do not place objects on top of the instrument panel as these objects may become projectiles in a collision or sudden stop.

## Climate Controls

### AUXILIARY A/C-HEATER CONTROLS (IF EQUIPPED)

Your vehicle may be equipped with auxiliary climate controls. These allow the front or rear seat passengers to control airflow direction, temperature and fan level of the rear compartment to quickly heat or cool the vehicle.

Auxiliary climate controls are located in the first row overhead console and in the floor console on the back of the front row console.

If the main climate control system is in the OFF position, the auxiliary climate control will not operate.



The auxiliary unit can be controlled either by the front seat occupant(s) using the front auxiliary control or by the rear seat passenger(s) using the rear auxiliary control but not both. To control the auxiliary unit using the rear control, the front auxiliary blower control must be in the REAR position.

#### Front auxiliary controls:

##### 1. Temperature control:

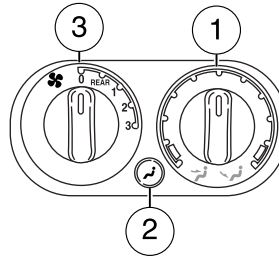
Determines airflow temperature in the rear of the vehicle. If the main climate control system is cooling in MAX A/C or  mode, the auxiliary temperature control will not function as the entire vehicle will operate at a full cool temperature.



2. **Mode selector:** Press to select air flow direction to  (Floor) or  (Panel).

 Directs air to the floor of the third row seating.

 Directs air to the overhead registers of the second and third row seating. The selected mode will illuminate on the temperature control.

3. **Fan control:** Determines fan speed in the auxiliary system. Turn to REAR to give rear seat passengers control of the rear auxiliary controls. Otherwise, the front auxiliary control will determine the settings for the auxiliary A/C-heater. If set to O (OFF), the rear auxiliary controls will not function.

## Climate Controls



### Rear auxiliary controls (if equipped):

Once the front auxiliary control is set to REAR, the rear seat passengers may use the rear auxiliary controls in the floor console to make the desired adjustments.

#### 1. Temperature control:

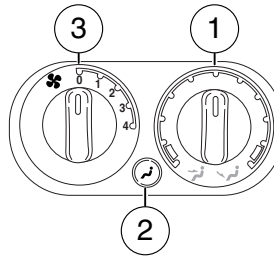
Determines temperature levels. If the main climate control system is cooling in MAX A/C or  mode, the auxiliary controls will not function as the entire vehicle will operate at a full cool temperature.



2. **Mode selector:** Press to select between air flow to  (Floor) or  (Panel).

 Directs air to the floor of the third row seating.

 directs air to the overhead registers of the second and third row seating. The selected mode will illuminate on the temperature control.

3. **Fan control:** Determines fan speed levels.

### REAR WINDOW DEFROSTER

Used to manually enable or disable rear window defrost in all modes.

After approximately 10 minutes of rear defrost operation, the climate

control system will automatically disable the rear defrost operation. If desired, the rear defrost can be manually disabled through the use of the rear defrost button. When operating, the rear defrost indicator will be lit.



**Do not use razor blades or other sharp objects to clean the inside of the rear window or to remove decals from the inside of the rear window. This may cause damage to the heated grid lines and will not be covered by your warranty.**



## Lights

### HEADLAMP CONTROL ☀

Rotate the headlamp control to the first position  $P \leq$  to turn on the parking lamps. Rotate to the second position  $\equiv \text{D}$  to turn on the headlamps.

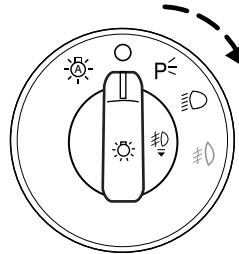

### Foglamp control $\# \text{D}$

The headlamp control also operates the foglamps. The foglamps can be turned on when the headlamp control is in the  $P \leq$ ,  $\text{☀}$  or  $\equiv \text{D}$  positions and the high beams are not turned on.

Pull headlamp control towards you to turn foglamps on. The foglamp indicator light  $\# \text{D}$  will illuminate.

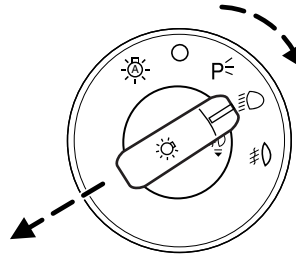

### Autolamp control $\text{☀}$

The autolamp system provides light sensitive automatic on-off control of the exterior lights normally controlled by the headlamp control.

The autolamp system also keeps the lights on for approximately 20 seconds or on vehicles equipped with a message center, you can select a delay from 0–180 seconds, after the ignition switch is turned to OFF.

- To turn autolamps on, rotate the control counterclockwise.
- To turn autolamps off, rotate the control clockwise to OFF.

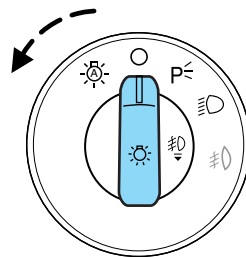

## Lights

### Daytime running lamps (DRL) (if equipped)

Turns the foglamps on at full intensity output. To activate:

- the ignition must be in the ON position and
- the headlamp control must be in the OFF or Parking lamps position.

 Always remember to turn on your headlamps at dusk or during inclement weather. The Daytime Running Lamp (DRL) system does not activate with your tail lamps and generally may not provide adequate lighting during these conditions. Failure to activate your headlamps under these conditions may result in a collision.

### High beams

Push the lever toward the instrument panel to activate. Pull the lever towards you to deactivate.

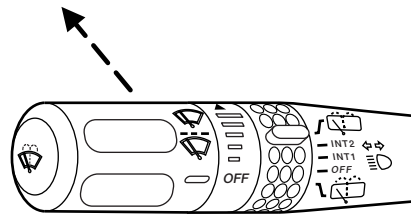

### Flash to pass

Pull toward you slightly to activate and release to deactivate.

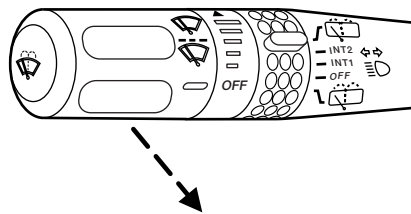

### PANEL DIMMER CONTROL

Use to adjust the brightness of the instrument panel and all applicable switches in the vehicle during headlamp and parklamp operation.

Move the control to the full upright position, past detent, to turn on the interior lamps.

Move the control to the full down position, past detent, to prevent the interior lights from illuminating when the doors are opened.

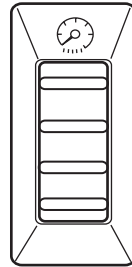

At dusk and dawn, the LEDs are illuminated at six times the normal intensity to enhance contrast and visibility. The system automatically “dims down” as ambient light reaches the dash-mounted sensor.

The interior control lights dim progressively in four steps until they reach nighttime operating levels. At all illumination levels, the lights can be dimmed using the thumbwheel on the instrument panel.

### VERTICAL AIM ADJUSTMENT

1. Park the vehicle on a level surface approximately 7.6 meters (25 feet) from a vertical wall or screen directly in front of it.

- (1) Eight feet
- (2) Center height of lamp to ground
- (3) Twenty-five feet
- (4) Horizontal reference line

2. Measure the height from the center of your headlamp (indicated by a 3.0 mm circle on the lens) to the ground and mark a 2.4 meter (8 foot) horizontal reference line on the vertical wall or screen at this height (a piece of masking tape works well).

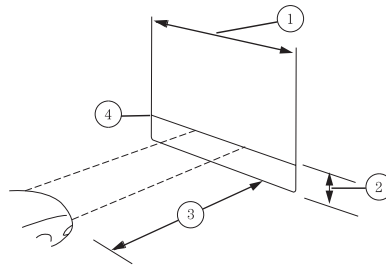

3. Turn on the low beam headlamps to illuminate the wall or screen and open the hood. Cover one of the headlamps so no light hits the wall.

## Lights

4. On the wall or screen you will observe a light pattern with a distinct horizontal edge towards the right. If this edge is not at the horizontal reference line, the beam will need to be adjusted so the edge is at the same height as the horizontal reference line.

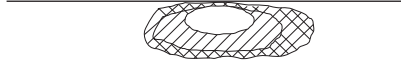

5. Locate the vertical adjuster on each headlamp, then use a 4 mm socket/wrench to turn the adjuster either counterclockwise (to adjust down) or clockwise (to adjust up) aligning the upper edge of the light pattern up to the horizontal line.

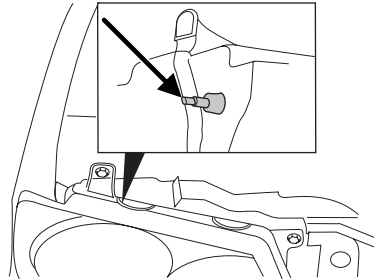

6. HORIZONTAL AIM IS NOT REQUIRED FOR THIS VEHICLE AND IS NON-ADJUSTABLE.

7. Repeat step 3–5 for the other headlamp.

8. Close the hood and turn off the lamps.

### TURN SIGNAL CONTROL ⇐⇒

- Push down to activate the left turn signal.
- Push up to activate the right turn signal.

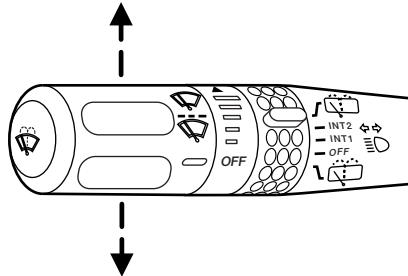

### INTERIOR LAMPS

#### Front row map lamps (if equipped)

To turn on the map lamps, press the rear edge of the lamp.

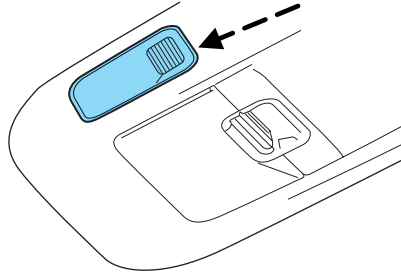

#### Rear dome lamp

The dome lamp lights when:

- any door is opened (and switch is in middle position).
- the instrument panel dimmer switch is held up until the courtesy lamps come on.
- any of the remote entry controls are pressed and the ignition is OFF (and switch is in the middle position).

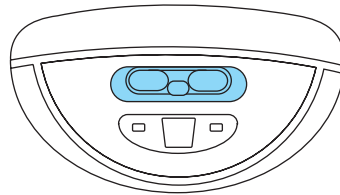

With the ignition key in the ACC or ON position, the rear dome lamp can be turned ON or OFF by sliding the control.

### BULBS

#### Replacing exterior bulbs

Check the operation of all the bulbs frequently.

#### Using the right bulbs

Replacement bulbs are specified in the chart below. Headlamp bulbs must be marked with an authorized "D.O.T." to assure lamp performance, light brightness and pattern and safe visibility. The correct bulbs will not damage the lamp assembly or void the lamp assembly warranty and will provide quality bulb burn time.

## Lights

Function	Number of bulbs	Trade number
Headlamps (low-beams)	2	9006
Headlamps (hi-beam)	2	9005
Front park/turn lamps	2	3157 AK (amber)
Front sidemarker	2	194 AK (amber)
Foglamps	2	800
Map/dome lamps	2	579
Rear cargo lamp	1	578
2nd row reading lamp	1	578
Turn/tail/brake lamps	2	3157K
Approach lamps	2	906
Mirror turn signal lamps	2	906 (amber)
Liftgate lamp	2	916
Backup lamp	2	3157K
License lamp	2	168
High-mount brake lamp	5	W5W
All replacement bulbs are clear in color except where noted.		
To replace all instrument panel lights - see your dealer		

\* For vehicles with HID (high intensity discharge) lamps, see your dealer for service.

### Replacing the interior bulbs

Check the operation of all bulbs frequently.

#### Map lamps

To change the map lamp bulbs:

1. Use a small screwdriver to remove the map lamp lens.
2. To remove the old bulb, twist  $\frac{1}{4}$  turn and pull it out.
3. Twist in a new bulb.
4. Align and press the map lamp lens back on and test the lamp operation.

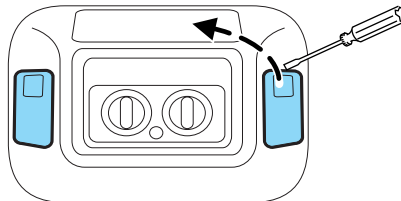

#### Replacing headlamp bulbs

1. Make sure the headlamp control is in the OFF position.
2. Open the hood.

## Lights

3. At the back of the headlamp lens, remove the three headlamp assembly retainers bolts.

4. Pull the headlamp assembly forward slightly to expose the electrical connectors.

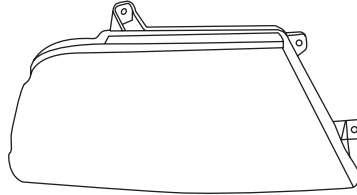

5. Rotate the bulb covers counterclockwise and remove.

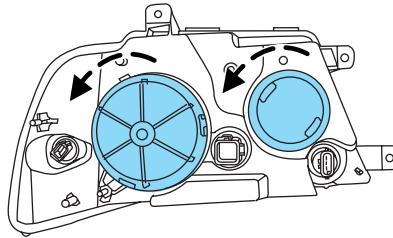

6. Once the bulb covers are removed, the bulbs can be removed by turning them counterclockwise and then pulling the bulbs straight out.

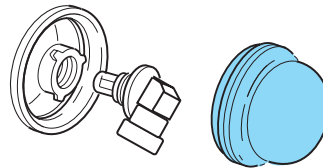

Handle a halogen headlamp bulb carefully and keep out of children's reach. Grasp the bulb only by its plastic base and do not touch the glass. The oil from your hand could cause the bulb to break the next time the headlamps are operated.

7. Insert the glass end of the new bulb into the headlamp assembly. When the grooves in the plastic base are aligned, push the bulb into the lamp assembly until the plastic base contacts the rear of the lamp assembly. Turn the bulb counterclockwise to install.

8. Reinstall the bulb cover and secure it in place by turning counterclockwise.

## Lights

### **Replacing HID headlamp bulbs (if equipped)**

The low beam headlamps on your vehicle use a “high intensity discharge” source. These lamps operate at a high voltage. The bulb is NOT replaceable. When the bulb is burned out, the lamp assembly must be replaced by your dealer or a qualified technician.

### **Replacing front parking lamp/turn signal bulbs**

1. Make sure the headlamp control is in the OFF position.
2. Open the hood.
3. At the back of the headlamp lens, remove the three headlamp assembly bolts.
4. Pull the headlamp assembly forward slightly to expose the electrical connectors.

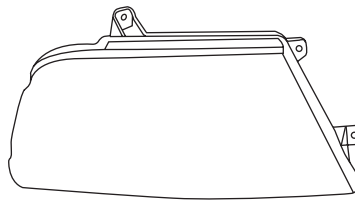

5. Rotate the bulb socket counterclockwise and remove.
6. Pull the bulb straight out of the socket and push in the new bulb.
7. To complete installation of the parking lamp/turn signal assembly, follow the removal procedures in reverse order.

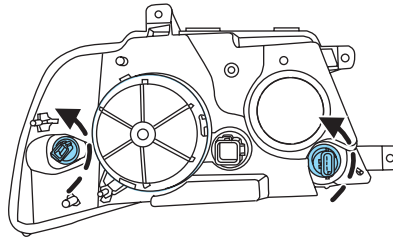

### **Replacing foglamp bulbs**



Handle a halogen headlamp bulb carefully and keep out of children's reach. Grasp the bulb only by its plastic base and do not touch the glass. The oil from your hand could cause the bulb to break the next time the headlamps are operated.



## Lights

1. Make sure the headlamp switch is in the OFF position.
2. Disconnect the electrical connector from the foglamp bulb.
3. Rotate the foglamp bulb counterclockwise and remove from the foglamp (the rear side of the foglamp is shown).
4. Install the foglamp bulb in foglamp by rotating clockwise.
5. Connect the electrical connector to the new foglamp bulb

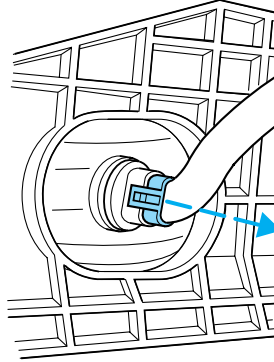

### **Replacing tail lamp bulbs**

1. Make sure the headlamp switch is in the OFF position.
2. Open the liftgate to expose the lamp assembly screws.
3. Remove the two screws from the lamp assembly.
4. Carefully pry the lamp assembly away from the vehicle, by pulling the assembly directly straight out, to expose the bulb socket. **DO NOT TIP THE LAMP ASSEMBLY SIDEWAYS.**
5. Rotate the bulb socket counterclockwise and remove from lamp assembly.
6. Pull bulb straight out of socket and push in the new bulb.
7. Install the bulb socket into the lamp assembly and rotate clockwise.
8. Install the lamp assembly on the vehicle and secure with two screws.

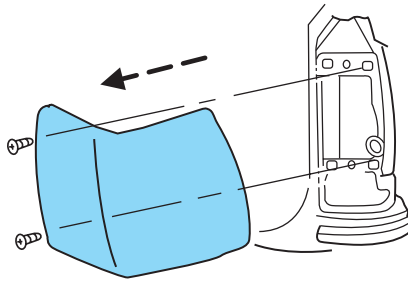

## Lights

### **Replacing back-up lamp bulbs**

The back-up lamp bulbs are located behind the liftgate trim panels.

To change the back-up lamp bulbs:

1. Make sure the headlamp switch is in the OFF position.
2. Remove the liftgate trim panel by removing the retaining nuts to expose the bulb socket.
3. Turn the bulb socket counterclockwise and pull it out of the back-up lamp assembly.
4. Pull out the old bulb and replace it by pushing in a new bulb.
5. Push the connector back into the back-up lamp assembly and turn it clockwise to secure it in place.
6. Reinstall the liftgate trim panel.

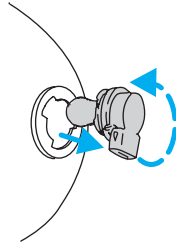

### **Replacing liftgate tail lamp bulb**

1. Make sure the headlamp switch is in the OFF position.
2. Raise the liftgate and remove the two retaining nuts on the underside of the liftgate.

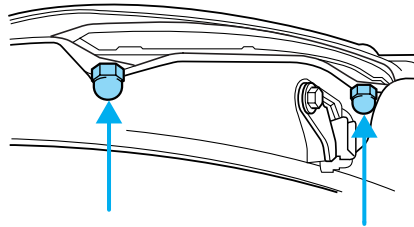

## Lights

3. Pull the lamp assembly straight out (it will snap out of a plastic retaining grommet).

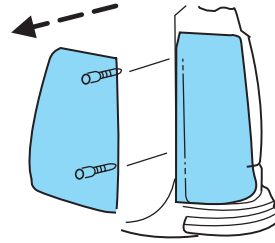

4. Turn the wire harness counterclockwise to remove it from the lamp.

5. Pull out the bulb and replace it with a new one.

6. Turn the harness clockwise to install it.

7. Snap the lamp assembly back into place.

8. Replace the retaining nuts.

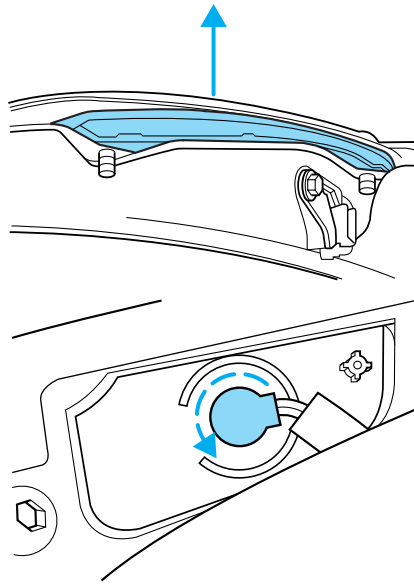

## Lights

### **High-mount brakelamp**

To change the high-mount brakelamp bulbs:

1. Remove the two screws holding the lamp assembly in place.

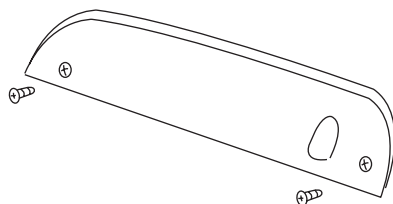

2. Pull the lamp assembly straight out.

3. Remove the wire harness.

4. Depress the four tabs that hold the light assembly on, one at a time, and pull the black bulb carrier away from the lamp.

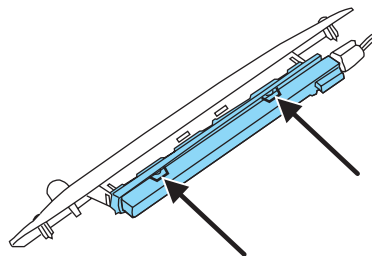

5. Pull the old bulb out and replace with the new bulb.

6. Snap the black bulb carrier into the lamp assembly.

7. Replace the wire harness.

8. Replace the lamp assembly.

## Lights

### **Replacing license plate lamp bulb**

The license plate bulbs are located in the license plate housing assembly on the liftgate. To change the license plate bulbs:

1. Make sure the headlamp switch is in the OFF position.
2. Remove the license lamp screw from the assembly.
3. Pull the lamp down and twist the bulb socket counterclockwise. Remove the bulb socket from the lamp.
4. Pull out the old bulb and push in the new bulb.

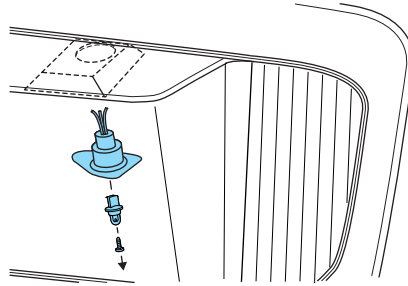

5. Install the bulb socket in the lamp assembly by turning it clockwise.
6. Install the lamp assembly and secure it with the retaining screw.

### **Approach lamp/mirror turn signal bulb removal (if equipped)**

To change the bulbs:

1. Make sure the headlamp switch is in the OFF position and then fold the mirror forward.
2. Remove the torx screw on the bottom of the turn signal lens using a T-10 torx driver.
3. Pull the turn signal lens down to remove it from the mirror assembly.
4. Disconnect the bulb assembly from the lens.
5. Remove and replace the bulb.
6. Reverse the order to reassemble lamp and lens.

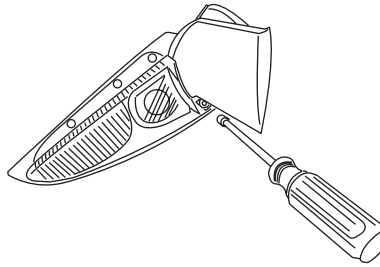

## Driver Controls

### MULTI-FUNCTION LEVER

**Windshield wiper:** Rotate the end of the control away from you to increase the speed of the wipers; rotate towards you to decrease the speed of the wipers.

**Speed dependent wipers:** When the wiper control is on, the speed of the wipers will automatically adjust with the vehicle speed. The faster your vehicle is travelling the faster the wipers will go.

**Windshield washer:** Push the end of the stalk:

- briefly: causes a single swipe of the wipers without washer fluid.
- a quick push and hold: the wipers will swipe three times with washer fluid.
- a long push and hold: the wipers and washer fluid will be activated for up to ten seconds.

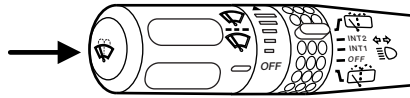
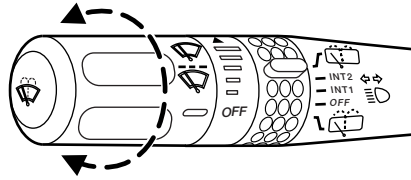

### Rear window wiper/washer controls

For rear wiper operation, rotate the rear window wiper and washer control to the desired position. Select:

INT 2 — Normal speed operation of rear wiper.

INT 1 — Intermittent operation of rear wiper.

OFF — Rear wiper and washer off.

For rear wash cycle, rotate (and hold as desired) the rear wiper/washer control to either  position.

From either position, the control will automatically return to the INT 2 or OFF position.

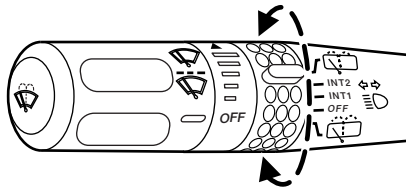

## Driver Controls

### Changing the wiper blades

It is recommended that wiper blades are renewed before winter.

To replace the wiper blades:

1. Fold back the wiper arm and position the wiper blade at right angles to the wiper arm.
2. To remove, press the retaining clip (A) to disengage the wiper blade, then pull the blade down toward the windshield to remove it from the arm.

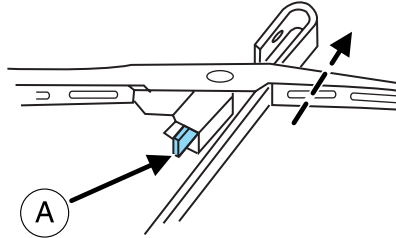

3. Install the new wiper blade on the arm and press it into place until a click is heard.

### Changing rear window wiper blade

The rear wiper arm is designed without a service position. This reduces the risk of damage to the blade in an automatic car wash.

To replace the wiper blade:

1. Lift and hold the wiper blade off the glass.
2. Press the release tab to unlock wiper blade from wiper arm.
3. Pull the wiper blade toward the base of the wiper arm and remove it from the arm.
4. Attach the new wiper to the wiper arm and press it into place until a click is heard.

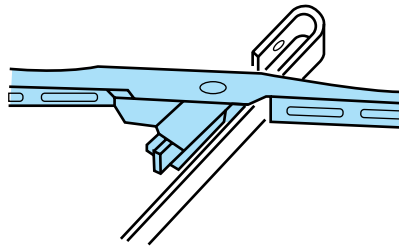

## Driver Controls

### TILT STEERING

Push the lever down to unlock the steering column. While the lever is in the down position, tilt the steering column to the desired position.

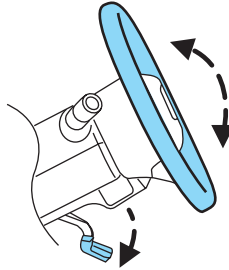

While holding the steering wheel, pull the lever up to its original position to lock the steering column.



Never adjust the steering column when the vehicle is moving.

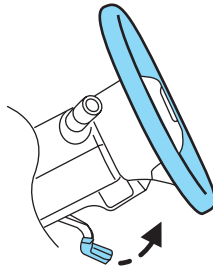

### ILLUMINATED VISOR MIRROR (IF EQUIPPED)

#### Type A

Lift the mirror cover to turn on the visor mirror lamps.

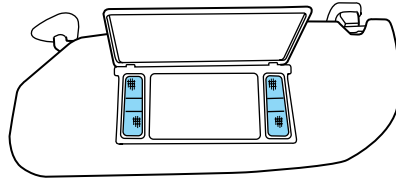

#### Type B

Lift the mirror cover to turn on the visor mirror lamp. The visor will slide back and forth on the rod for increased sunlight coverage.

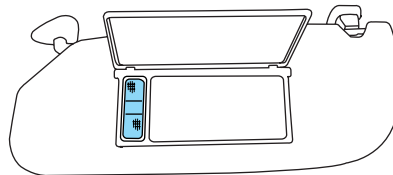



## Driver Controls

### OVERHEAD CONSOLE

The appearance of your vehicle's overhead console will vary according to your option package.

#### Forward storage bin and conversation mirror (if equipped)

The storage compartment may be used to store two pairs of sunglasses or similar objects. Press the release control to open the storage compartment. The door will open slightly and can be moved to full open.

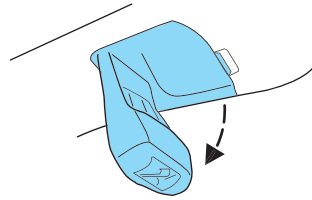

The conversation mirror on the cover allows the driver to view the rear seating area.



This does not replace the rear view mirror.

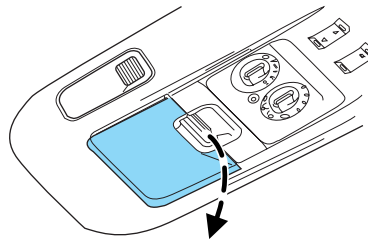

#### Moon roof (if equipped)

The moon roof control is located on the overhead console.



Do not let children play with the moon roof. They may seriously hurt themselves.

**Note:** The moon roof will open to the “**comfort**” position first before opening all the way. The “comfort” position helps to alleviate rumbling wind noise which may happen in the vehicle with the roof fully opened.

## Driver Controls

**To open the moon roof:** The moon roof is equipped with a one-touch open feature. Press and release the ▲ control. The moon roof will open to the “comfort” position. Press and release the control again to fully open. To stop the one-touch open feature press either the ▲ or ▼ control again.

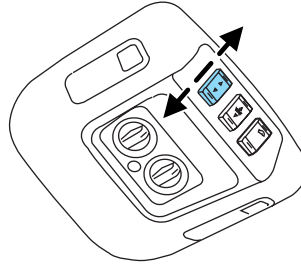

**To close the moon roof:** Press and hold the ▼ control until the glass panel stops at the “comfort” position. Press and hold the control again until the glass stops moving. When fully closed, the rear portion of the glass panel will appear higher than the front portion.

**To vent the moon roof:** Press and hold the ▼ control. **The moon roof must be in the closed position in order to move it into the vent position.** To close, press and hold the ▲ control until the glass panel stops moving.

The moon roof has a built-in sliding shade that can be manually opened or closed when the glass panel is shut. To close the shade, pull it toward the front of the vehicle.



When closing the moon roof, you should verify that it is free of obstructions and ensure that children and/or pets are not in the proximity of the moon roof opening.

## Driver Controls

### Power quarter rear windows

- Without a moon roof

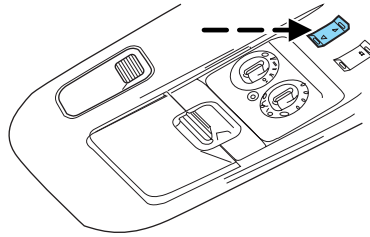

- With a moon roof

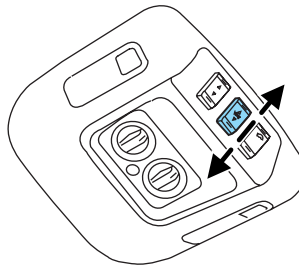

Press the ▲ portion of the VENT control to open the power rear quarter windows.

Press the ▼ portion of the VENT control to close the power rear quarter windows.

## Driver Controls

### Power liftgate control (if equipped)

Without a moon roof

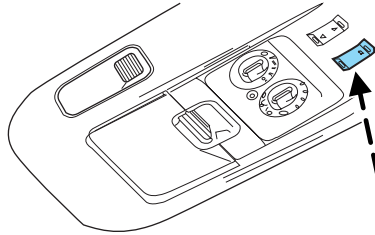

With a moon roof

Press and release the top portion of the control to open the power liftgate.

Press and release the top portion of the control again to close the power liftgate.

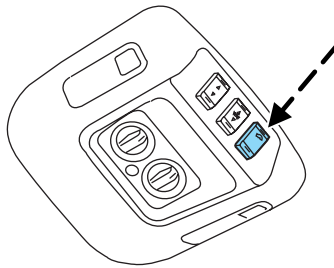

Make sure all persons are clear of the power liftgate area before using the power liftgate control.

### CLOCK

Press the right control to increase the time displayed.

Press the left control to decrease the time displayed.

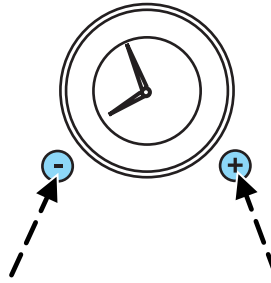

## Driver Controls

### AUXILIARY POWER POINT

**Power points are designed for accessory plugs only. Do not hang any type of accessory or accessory bracket from the plug. Improper use of the power points can cause damage not covered by your warranty.**

An auxiliary power point is located by the passenger's ankle near the floor in the front console bin.

Do not plug optional electrical accessories into the cigarette lighter. Use the power point.

Do not use the power point for operating the cigarette lighter element.

The Maximum power each power point can supply depends on the fuse rating. For example: a 20A fuse should supply a maximum of 240 Watts, a 15A fuse should supply a maximum of 180 Watts and a 10A fuse should supply a maximum of 120 Watts. Exceeding these limits will result in a blown fuse.

Always keep the power point caps closed when not being used.

A second auxiliary power point is located inside the cupholder door on the rear side of the center console. The power point is accessible from the rear seats.

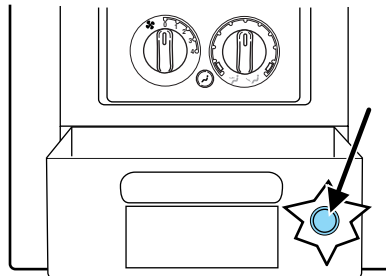
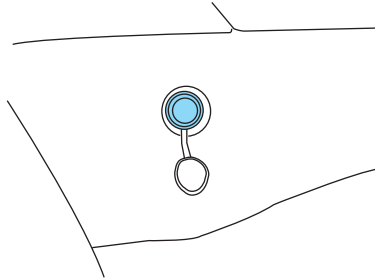

## Driver Controls

A third auxiliary power point is located on the right rear quarter panel. The power point is accessible from the liftgate.

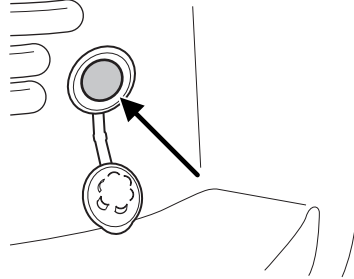

## POWER WINDOWS

 When closing the power windows, you should verify they are free of obstructions and ensure that children and/or pets are not in the proximity of the window openings.

The power window switches located on the center console are called push-pull switches.

- A. Drivers side
- B. Window lock
- C. Front passenger side
- D. Left and right rear passenger

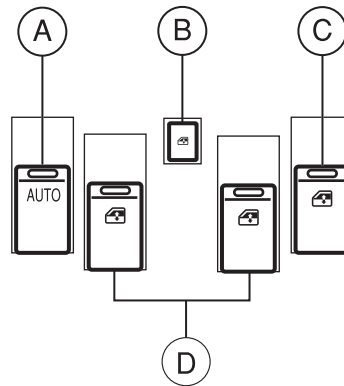

## Driver Controls

The following views are the driver's side switches:

### Normal operation

- Push down (to the first detent) and hold the top portion of the switch to open.

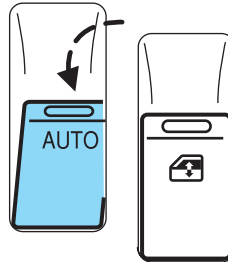

- Pull up (to the first detent) and hold the top portion of the switch to close.

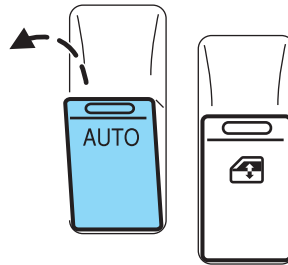

The following view is the power window switch on the rear door trim panels.

- Press and hold the top or bottom of the rear rocker switches to open or close.

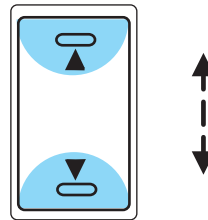

## Driver Controls

### One touch up or down (if equipped)

This feature is present on the driver's window only.

To operate ONE TOUCH DOWN:

- Press the switch completely down to the second detent and release quickly. The driver's window will open fully. Momentarily press the switch to any position to stop the window operation.

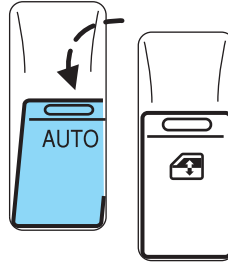

If the switch is pressed and held to the normal close or ONE TOUCH UP position during a ONE TOUCH DOWN event, the window will stop. If, after 1/2 second the switch is still held, the window will perform a normal close or ONE TOUCH UP.

To operate ONE TOUCH UP:

- Pull the switch completely up to the second detent and release quickly. The driver's window will close fully. Momentarily press the switch to any position to stop the one touch up.

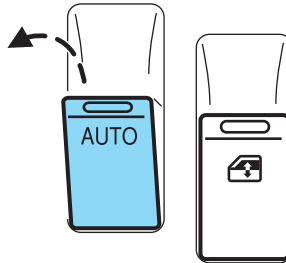

If the switch is pressed and held to the normal open or ONE TOUCH DOWN position during a ONE TOUCH UP event, the window will stop. If, after 1/2 second the switch is still held, the window will perform a normal open or ONE TOUCH DOWN.

### **Bounce-Back**

When an obstacle has been detected in the window opening as the window is moving upward, the window will automatically reverse direction and move down. This is known as "bounce-back". If the ignition is turned OFF (without accessory delay being active) during bounce-back, the window will move down until the bounce back position is reached.



## Driver Controls

### Security Override

If during a bounce-back condition, the switch is released to the neutral position, then held in the one touch up position within two seconds after the window reaches the bounce-back position, **the window will travel up with no bounce-back protection.** If the switch is released before the window reaches fully closed or the ignition is turned OFF (without accessory delay being active), the window will stop. Security override can be used if there is ice on the window or seals, causing a restriction.

### Window lock

The window lock feature allows only the driver to operate the rear power windows.

To lock out the rear window controls push the control down. To restore the rear window controls, push the control down. The control will spring back up to the neutral position.

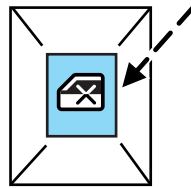

### Accessory delay

With accessory delay, the radio, windows, and moonroof operate for up to ten minutes after the ignition switch is turned from the ON to the OFF position or until any door is opened.

## MIRRORS

### Automatic dimming inside rear view mirror

Your vehicle is equipped with an inside rear view mirror which has an auto-dimming function. The electronic day/night mirror will change from the normal state to the non-glare state when bright lights (glare) reach the mirror. When the mirror detects bright light from behind the vehicle, it will automatically adjust (darken) to minimize glare.

The mirror will automatically return to the normal state whenever the vehicle is placed in R (Reverse)(when the mirror is on) to ensure a bright clear view when backing up.

Do not block the sensor on the backside of the mirror since this may impair proper mirror performance.

## Driver Controls

### Without Navigation System

Will automatically adjust (darken) to minimize glare.

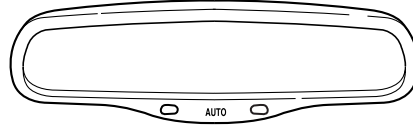

### With Navigation System

The illuminated LED to the right of the AUTO button indicates if the mirror is in the auto-dimming function. To turn the mirror off push the OFF button until the LED goes out.

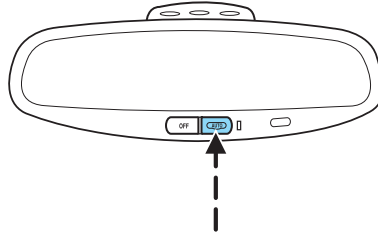

### Power side view mirrors

The ignition can be in any position to adjust the power side view mirrors.

To adjust your mirrors:

1. Select ◀ to adjust the left mirror or ▶ to adjust the right mirror.
2. Move the center control in the direction you wish to tilt the mirror.
3. Return to the center position to disable adjust function.

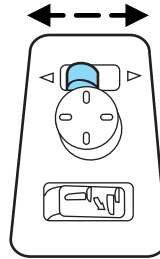

## Driver Controls

### Heated outside mirrors

Both mirrors are heated automatically to remove ice, mist and fog when the rear window defrost is activated.

**Do not remove ice from the mirrors with a scraper or attempt to readjust the mirror glass if it is frozen in place. These actions could cause damage to the glass and mirrors.**

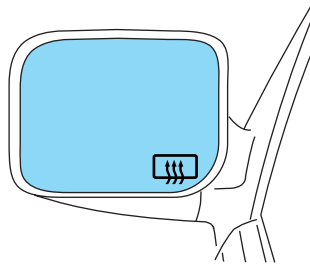

### Signal indicator mirrors

When the turn signal is activated, the lower portion of the mirror housing will blink.

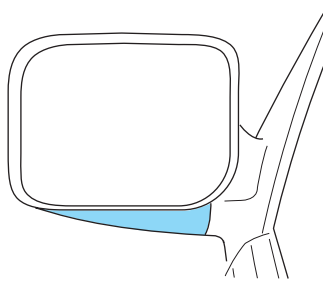

### Power fold mirrors

Press the control to retract or extend the outside rear view mirrors.

If the mirrors are pushed-in or pulled-out manually, press the control to retract the outside rear view mirrors and wait a short period (8 seconds), then deploy the mirrors as desired.

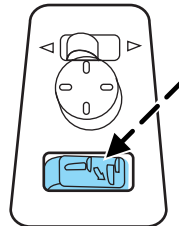

Use caution in certain instances (i.e. automatic car washes) in order to avoid damage to the mirrors.

## Driver Controls

### POWER ADJUSTABLE FOOT PEDALS

The accelerator and brake pedal should only be adjusted when the vehicle is stopped and the gearshift lever is in the P (Park) position.

Press and hold the rocker control to adjust accelerator and brake pedal.

- Press the bottom of the control to adjust the pedals toward you.
- Press the top of the control to adjust the pedals away from you.

The adjustment allows for approximately 76 mm (3 inches) of maximum travel.

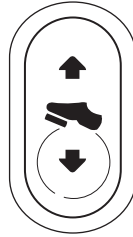

Never adjust the accelerator and brake pedal with feet on the pedals while the vehicle is moving.

### POWER DEPLOYABLE RUNNING BOARDS (IF EQUIPPED)

Deployable running boards (DRB) automatically move when the doors are opened to assist entering and exiting the vehicle.

Automatic power deploy:

- The running boards will extend out when the doors are opened.

Automatic power stow:

- The running boards will return to the stowed position when the doors are closed.

Manual power deploy:

To manually operate the running boards, refer to the *Message Center* in this chapter.

- This feature can manually set the running boards in the deployed position for access to the roof.
- When running boards are manually set in the deployed or stowed position, they will move back to the automatic position when the vehicle speed is greater than 7 km (5 mph).

Enable/disable:

To enable/disable the power running board feature, refer to the *Message Center* in this chapter.

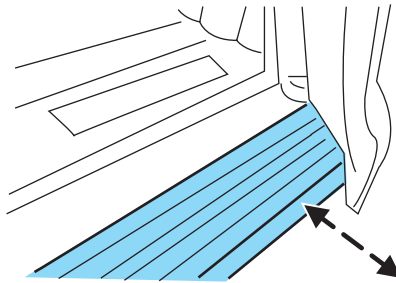

## Driver Controls

- When this feature is disabled, the running boards will immediately move to the stowed position regardless of the position of the doors.
- When this feature is enabled, the running boards will immediately move to the correct position based on the position of the doors.

Bounce-back:

- If an object is in the way of the moving running board, the running board will automatically bounce back in the reverse direction and move to the end of travel.

**Note:** The running boards may operate slower in cooler temperatures. In adverse conditions, mud, slush, salt, and other road debris may become trapped in the running board mechanism possibly causing unwanted noise. If this occurs flush the underside of the running boards using a high-pressure car wash.



In extreme climates, excessive ice buildup may occur, causing the running boards not to deploy. Be sure that the running boards have deployed, and have finished moving before attempting to step on them. Note: The running boards will resume normal function once the blockage is cleared.



Turn off the running boards before jacking or placing any object under the vehicle. Never place your hand between the extended running board and the vehicle. A moving running board may cause injury.

## SPEED CONTROL

With speed control set, you can maintain a speed of 48 km/h (30 mph) or more without keeping your foot on the accelerator pedal. Speed control does not work at speeds below 48 km/h (30 mph).



Do not use the speed control in heavy traffic or on roads that are winding, slippery or unpaved.

## Driver Controls

### Setting speed control

The controls for using your speed control are located on the steering wheel for your convenience.

1. Press the ON control and release it.
2. Accelerate to the desired speed.

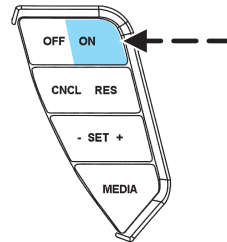

3. Press the SET + control and release it.
4. Take your foot off the accelerator pedal.
5. The indicator  light on the instrument cluster will turn on.

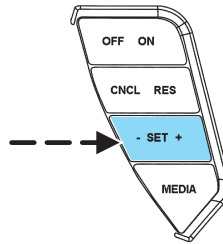

### Note:

- Vehicle speed may vary momentarily when driving up and down a steep hill.
- If the vehicle speed increases above the set speed on a downhill, you may want to apply the brakes to reduce the speed.
- If the vehicle speed decreases more than 16 km/h (10 mph) below your set speed on an uphill, your speed control will disengage.

## Driver Controls

### **Resuming a set speed**

Press the RES control and release it. This will automatically return the vehicle to the previously set speed. The RES control will not work if the vehicle speed is not faster than 48 km/h (30 mph).

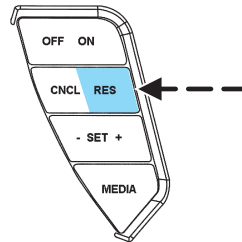

### **Increasing speed while using speed control**

There are two ways to set a higher speed:

- Press and hold the SET + control until you get to the desired speed, then release the control. You can also use the SET + control to operate the Tap-Up function. Press and release this control to increase the vehicle set speed in small amounts by 1.6 km/h (1 mph).
- Use the accelerator pedal to get to the desired speed. When the vehicle reaches that speed press and release the SET + control.

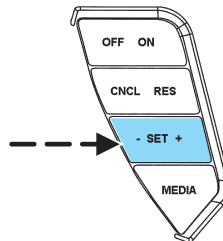

### **Reducing speed while using speed control**

There are two ways to reduce a set speed:

- Press and hold the SET - control until you get to the desired speed, then release the control. You can also use the SET - control to operate the Tap-Down function. Press and release this control to decrease the vehicle set speed in small amounts by 1.6 km/h (1 mph).

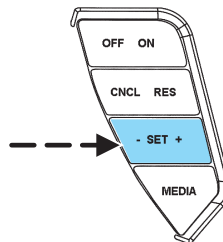

## Driver Controls

- Depress the brake pedal or press CNCL (Cancel) until the desired vehicle speed is reached, press the SET + control.

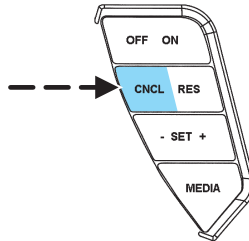

### Turning off speed control

There are two ways to turn off the speed control:

- Depress the brake pedal or press CNCL (Cancel). This will not erase your vehicle's previously set speed.
- Press the speed control OFF control.

**Note:** When you turn off the speed control or the ignition, your speed control set speed memory is erased.

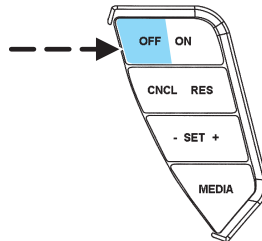

## STEERING WHEEL CONTROLS

These controls allow you to operate some radio and climate control features.

### Audio control features

Press MEDIA to select:

- AM, FM1, FM2,
- TAPE, or
- CD.

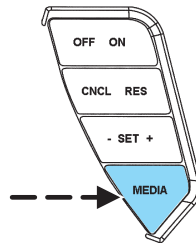



## Driver Controls

### In AM, FM1, or FM2 mode:

- Press MEM to select preset stations within the selected radio band.

### In Tape mode:

- Press MEM to select the next selection on the tape.

### In CD mode:

- Press MEM to select the next selection on the CD.

### In any mode:

- Press VOL + or - to adjust volume.

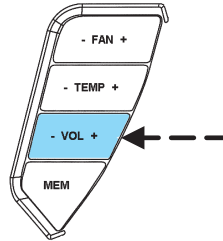
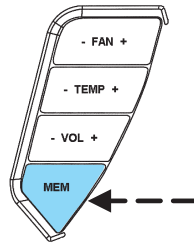

### Climate control features

Press TEMP + or - to adjust temperature.

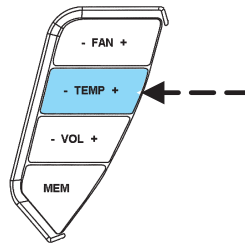

## Driver Controls

Press FAN + or - to adjust fan speed.

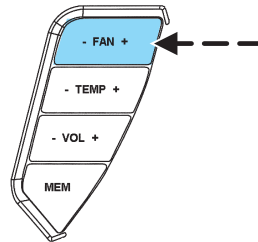

### Navigation steering wheel controls (if equipped)

These controls allow you to operate some audio and navigation control features when the vehicle is equipped with the navigation feature.

#### Audio control features

Press  to select:

- AM, FM1, FM2, or
- CD.

#### In AM, FM1, or FM2 mode:

- Press NEXT to select preset stations within the selected radio band.

#### In CD mode:

- Press NEXT to select the next track on the CD.

#### In any mode:

- Press VOL + or - to adjust volume.

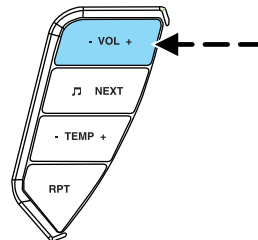
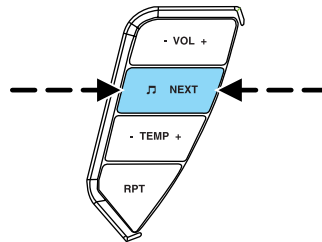

## Driver Controls

### Navigation control features

Press and hold VOICE briefly until the voice  icon appears on the Navigation display to use the Navigation voice command.

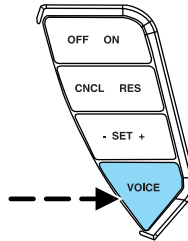

Press RPT (REPEAT) control to hear previous command repeated from the navigation system.

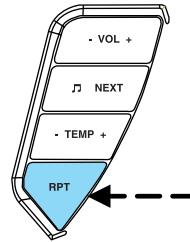

### Climate control features

Press TEMP + or - to adjust temperature.

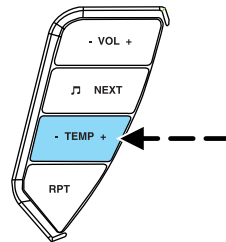

### HOMELINK® WIRELESS CONTROL SYSTEM

The HomeLink® Wireless Control System, located on the driver's visor, provides a convenient way to replace up to three hand-held transmitters with a single built-in device. This feature will learn the radio frequency codes of most current transmitters to operate garage doors, entry gate operators, security systems, entry door locks, and home or office lighting.

## Driver Controls



When programming your HomeLink® Wireless Control System to a garage door or gate, be sure that people and objects are out of the way to prevent potential harm or damage.

Do not use the HomeLink® Wireless Control System with any garage door opener that lacks safety stop and reverse features as required by U.S. federal safety standards (this includes any garage door opener model manufactured before April 1, 1982). A garage door which cannot detect an object, signaling the door to stop and reverse, does not meet current U.S. federal safety standards. For more information, contact HomeLink® at: **www.homelink.com** or **1-800-355-3515**.

Retain the original transmitter for use in other vehicles as well as for future programming procedures (i.e. new HomeLink® equipped vehicle purchase). It is also suggested that upon the sale of the vehicle, the programmed HomeLink® buttons be erased for security purposes, refer to *Programming* in this section.

### Programming

**Do not program HomeLink® with the vehicle parked in the garage.**

**Note:** Your vehicle may require the ignition switch to be turned to the ACC position for programming and/or operation of the HomeLink®. It is also recommended that a new battery be placed in the hand-held transmitter of the device being programmed to HomeLink® for quicker training and accurate transmission of the radio-frequency signal.

1. Press and hold the two outside buttons releasing only when the red light begins to flash after 20 seconds. **Do not** repeat step one to program additional hand-held transmitters to the remaining two HomeLink® buttons. This will erase previously programmed hand-held transmitter signals into HomeLink®.

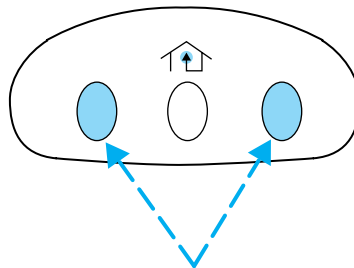

2. Position the end of your hand-held transmitter 2–8 cm (1–3 inches) away from the HomeLink® button you wish to program (located on your visor) while keeping the red light in view.

## Driver Controls

3. Simultaneously press and hold both the HomeLink® and hand-held transmitter button. **Do not release the buttons until step 4 has been completed.**

Some entry gates and garage door openers may require you to replace step 3 with procedures noted in the “Gate Operator and Canadian Programming” in this section for Canadian residents.

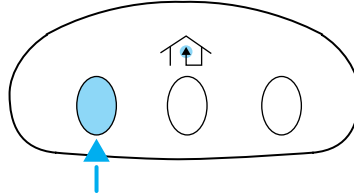

4. The red light will flash slowly and then rapidly. Release both buttons when the red light flashes rapidly. (The rapid flashing light indicates acceptance of the hand-held transmitters' radio frequency signals.)

5. Press and hold the just-trained HomeLink® button and observe the red light. If the light is a constant red, programming is complete and your device should activate when the HomeLink® button is pressed and released. **Note:** To program the remaining two HomeLink® buttons, begin with step 2 in the “Programming” section — **do not** repeat step 1.

**Note:** If the red light blinks rapidly for two seconds and then turns to a continuous red, proceed with steps 6 through 8 to complete programming of a rolling code equipped device.

6. At the garage door opener receiver (motor-head unit) in the garage, locate the “learn” or “smart” button (usually near where the hanging antenna wire is attached to the unit).

7. Press and release the “learn” or “smart” button. (The name and color of the button may vary by manufacturer.)

**Note:** There are 30 seconds in which to initiate step eight.

8. Return to the vehicle and firmly press, hold for two seconds and release the HomeLink® button. Repeat the press/hold/release sequence again, and, depending on the brand of the garage door opener (or other rolling code equipped device), repeat this sequence a third time to complete the programming.

HomeLink® should now activate your rolling code equipped device. To program additional HomeLink® buttons begin with step 2 in the “Programming” section. For questions or comments, please contact HomeLink at **www.homelink.com** or **1-800-355-3515**.

## Driver Controls

### Gate Operator & Canadian Programming

During programming, your hand-held transmitter may automatically stop transmitting — not allowing enough time for HomeLink® to accept the signal from the hand-held transmitter.

After completing steps 1 and 2 outlined in the “Programming” section, replace step 3 with the following:

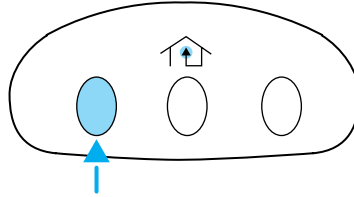

**Note:** If programming a garage door opener or gate operator, it is advised to unplug the device during the “cycling” process to prevent overheating.

- Continue to press and hold the HomeLink® button (note step 3 in the “Programming” section) while you press and release — **every two seconds** (“cycle”) your hand-held transmitter until the frequency signal has been accepted by the HomeLink®. The red indicator light will flash slowly and then rapidly after HomeLink® accepts the radio frequency signal.
- Proceed with step 4 in the “Programming” section.

### Operating the HomeLink® Wireless Control System

To operate, simply press and release the appropriate HomeLink® button. Activation will now occur for the trained product (garage door, gate operator, security system, entry door lock, or home or office lighting etc.). For convenience, the hand-held transmitter of the device

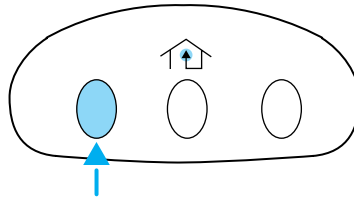

may also be used at any time. In the event that there are still programming difficulties, contact HomeLink® at [www.homelink.com](http://www.homelink.com) or **1-800-355-3515**.

## Driver Controls

### Erasing HomeLink® buttons

To erase the three programmed buttons (individual buttons cannot be erased):

- Press and hold the two outer HomeLink® buttons until the red indicator light begins to flash—after 20 seconds. Release both buttons. Do not hold for longer than 30 seconds.

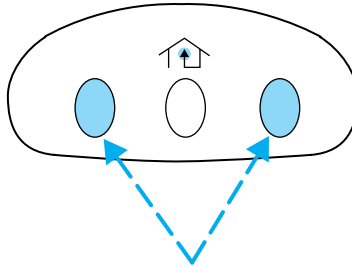

HomeLink® is now in the train (or learning) mode and can be programmed at any time beginning with step 2 in the “Programming” section.

### Reprogramming a single HomeLink® button

To program a device to HomeLink® using a HomeLink® button previously trained, follow these steps:

1. Press and hold the desired HomeLink® button. **Do NOT** release the button.
2. The red indicator light will begin to flash after 20 seconds. Without releasing the HomeLink® button, follow step 2 in the “Programming” section.

For questions or comments, contact HomeLink® at [www.homelink.com](http://www.homelink.com) or **1-800-355-3515**.

### MESSAGE CENTER

With the ignition in the ON position, the message center, located on your instrument cluster, displays important vehicle information

**through a constant monitor of vehicle systems.** You may select

display features on the message center for a display of status preceded by a brief indicator chime. The system will also notify you of potential vehicle problems with a display of system warnings followed by a long indicator chime.

#### MESSAGE CENTER



## Driver Controls

### Selectable features

#### **Reset**

Press this control to select and reset functions shown in the INFO menu and SETUP menu.



#### **Info menu**

This control displays the following control displays:

- Trip odometer/Odometer/Compass
- Distance to Empty
- Average Fuel Economy
- Trip Elapsed Drive Time



#### **Odometer/Trip odometer**

Refer to *Gauges* in the *Instrument Cluster* chapter.

#### **Compass display**

The compass reading may be affected when you drive near large buildings, bridges, power lines and powerful broadcast antenna. Magnetic or metallic objects placed in, on or near the vehicle may also affect compass accuracy.

Usually, when something affects the compass readings, the compass will correct itself after a few days of operating your vehicle in normal conditions. If the compass still appears to be inaccurate, a manual calibration may be necessary. Refer to *Compass zone/calibration adjustment*.

Most geographic areas (zones) have a magnetic north compass point that varies slightly from the northerly direction on maps. This variation is four



## Driver Controls

degrees between adjacent zones and will become noticeable as the vehicle crosses multiple zones. A correct zone setting will eliminate this error. Refer to *Compass zone/calibration adjustment*.

### **Compass zone/calibration adjustment**

1. Determine your magnetic zone by referring to the zone map.
2. Turn ignition to the ON position.
3. Start the engine.
4. From Info menu, select the Compass/Odometer function. (Do not select Trip, DTE, or AFE. The top of the message center must be blank).

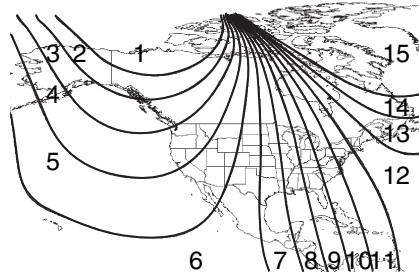

5. Press and hold the SETUP and RESET controls until the message center display changes to show the current zone setting (XX).

RESET FOR ZONE  
INFO TO EXIT

6. Press the SETUP control repeatedly until the correct zone setting for your geographic location is displayed on the message center. The range of zone values are from 01 to 15 and “wraps” back to 01.

SETUP ZONE XX  
RESET IF DONE

7. To exit the zone setting mode, and to “lock in” your change, press and release the RESET control.

RESET FOR CAL  
INFO TO EXIT

Perform compass calibration in an open area free from steel structures and high voltage lines. For optimum calibration, turn off all electrical accessories (heater/air conditioning, wipers, etc.) and make sure all vehicle doors are shut.

## Driver Controls

8. Press the RESET control to start the compass calibration function.

CIRCLE SLOWLY  
TO CALIBRATE

9. Slowly drive the vehicle in a circle (less than 5 km/h [3 mph]) until the CIRCLE SLOWLY TO CALIBRATE display changes to CALIBRATION COMPLETED. It will take up to five circles to complete calibration.

10. The compass is now calibrated.

CALIBRATION  
COMPLETED

### **Average fuel economy (AFE)**

Select this function from the INFO menu to display your average fuel economy in liters/100 km or miles/gallon.

XX AVE MPG  
NW 000000.0 MI

If you calculate your average fuel economy by dividing liters of fuel used by 100 kilometers traveled (miles traveled by gallons used), your figure may be different than displayed for the following reasons:

- Your vehicle was not perfectly level during fill-up
- Differences in the automatic shut-off points on the fuel pumps at service stations
- Variations in top-off procedure from one fill-up to another
- Rounding of the displayed values to the nearest 0.1 liter (gallon)

1. Drive the vehicle at least 8 km (5 miles) with the speed control system engaged to display a stabilized average.

2. Record the highway fuel economy for future reference.

It is important to press the RESET control after setting the speed control to get accurate highway fuel economy readings.

## Driver Controls

### **Trip elapsed drive time**

Select this function from the INFO menu to display a timer.

To operate the Trip Elapsed Drive Time perform the following:

1. Press and release RESET in order to start the timer.
2. Press and release RESET to pause the timer.
3. Press and hold RESET for 2 seconds in order to reset the timer.



TIME XX:XX:XX  
NW 000000.0 MI

### **Distance to empty (DTE)**

Selecting this function from the INFO menu estimates approximately how far you can drive with the fuel remaining in your tank under normal driving conditions.

Remember to turn the ignition OFF when refueling to allow this feature to correctly detect the added fuel.

The DTE function will display LOW FUEL LEVEL and sound a tone for one second when you have approximately 80 km (50 miles) to empty. If you RESET this warning message, this display and tone will return within 10 minutes.

DTE is calculated using a running average fuel economy, which is based on your recent driving history of 800 km (500miles). This value is not the same as the average fuel economy display. The running average fuel economy is reinitialized to a factory default value if the battery is disconnected.



XXX MILES TO E  
NW 000000.0 MI

### **Setup menu**

Press this control for the following displays:

- System Check
- Units (English/Metric)
- Autolock
- Easy Exit Seat
- Autolamp Delay
- Power Liftgate (if equipped)
- Power Deployable Running Boards (if equipped)
- Language

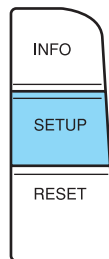

## Driver Controls

### **Autolocks**

This feature automatically locks all vehicle doors when the vehicle is shifted into any gear, putting the vehicle in motion.

1. To disable/enable the autolock feature, select this function from the SETUP control for the current display mode.



AUTO LOCKS  
< ON > OFF

2. Press the RESET control to turn the autolocks ON or OFF.

### **Easy exit seat**

This feature automatically moves the drivers seat backwards for easy exit from the vehicle.

1. To disable/enable the easy exit seat feature, select this function from the SETUP control for the current display mode.



EASY EXIT SEAT  
< ON > OFF

2. Press the RESET control to turn the easy entry exit seat ON or OFF.

### **Autolamp delay**

This feature keeps your headlights on for up to three minutes after the ignition is switched off.

1. To disable/enable the autolamp delay feature, select this function from the SETUP control for the current display mode.



AUTOLAMP  
DELAY = XXX SEC

2. Press the RESET control to select a new Autolamp delay value.

### **Reverse Sensing System**

This feature sounds a warning tone to warn the driver of obstacles near the rear bumper, and functions only when R (Reverse) gear is selected.

1. To disable/enable the reversing sensing system feature, put the vehicle in R (Reverse) and select this function from the SETUP control for the current display mode.



PARK ASSIST  
< ON > OFF

2. Press the RESET control to turn the rear park assist ON or OFF.

## Driver Controls

### **Power Liftgate (if equipped)**

This feature allows users to open/close the rear liftgate at the touch of a button.

1. To disable/enable the power liftgate feature, select this function from the SETUP control for the current display mode.

POWER LIFTGATE  
ON <OFF>

2. Press the RESET control to turn the power liftgate ON or OFF. If disabled, the button on the overhead console will not respond when pressed.

### **Power Deployable Running Boards (if equipped)**

This feature moves the running boards in and out when a door is opened or closed.

1. To disable/enable the power running board feature, select this function from the SETUP control for the current display mode.

RUNNING BOARDS  
<ON> OFF

2. Press the RESET control to turn the power running boards ON (enabled) or OFF (disabled).

When you select ON, press the SETUP control again to display "RUNNING BOARDS <AUTO> MANUAL".

RUNNING BOARDS  
<AUTO> MANUAL

3. Press the RESET control to manually set the power running boards in the MANUAL (deployed) position with the doors closed. When AUTO is selected the running boards resume to the automatic mode.

RUNNING BOARDS  
AUTO <MANUAL>

### **Language**

1. Select this function from the SETUP menu for the current language to be displayed.

ENGLISH  
RESET FOR NEW

## Driver Controls

2. Pressing the RESET control cycles the message center through each of the language choices.

FOR ENGLISH  
HOLD RESET

3. Press and hold the RESET control to set the language choice.

SET TO  
ENGLISH

### **Units (English/Metric)**

1. Select this function from the SETUP menu for the current units to be displayed.

UNITS  
< ENG > METRIC

2. Press the RESET control to change from English to Metric.

### **System check**

Selecting this function from the SETUP menu causes the message center to cycle through each of the systems being monitored. For each of the monitored systems, the message center will indicate either an OK message or a warning message for three seconds.

PRESS RESET  
FOR SYS CHECK

Pressing the RESET control cycles the message center through each of the systems being monitored.

The sequence of the system check report and how it appears in the message center is as follows:

- |                       |                         |
|-----------------------|-------------------------|
| 1. FUEL LEVEL         | 6. TIRE PRESSURE SYSTEM |
| 2. WASHER FLUID LEVEL | 7. BRAKE FLUID LEVEL    |
| 3. ENGINE TEMP        | 8. CHARGING SYSTEM      |
| 4. ADVTRAC            | 9. AIR SUSPENSION       |
| 5. OIL PRESSURE       |                         |

## Driver Controls

### System warnings

System warnings alert you to possible problems or malfunctions in your vehicle's operating systems.

In the event of a multiple warning situation, the message center will cycle the display to show all warnings by displaying each one for 4 seconds.

The message center will display the last selected feature if there are no more warning messages. This allows you to use the full functionality of the message center after you acknowledge the warning by pressing the RESET control and clearing the warning message.

Warning messages that have been reset are divided into three categories:

- They will reappear on the display every minute from the time of reset.
- They will reappear on the display ten minutes from the reset.
- They will not reappear until an ignition OFF-ON cycle has been completed.

This acts as a reminder that these warning conditions still exist within the vehicle.

Warning display	Status
Check park assist	Warning displays when R (reverse) gear is selected.
PRNDL error no park assist	
AdvTrac ON	Displays for 4 seconds
AdvTrac OFF	
Power liftgate off	
Door ajar	Warning returns after 10 minutes
Liftgate ajar	
Warning-tire very low	
Low fuel level	
Check charging system	
Low brake fluid level	
Low oil pressure	
Check engine temperature	
Reduced engine power	
Stop engine safely	

## Driver Controls

Warning display	Status
Check tire pressure	Warning returns after the ignition key is turned from OFF to ON.
Tire pressure system fault	
Tire pressure sensor fault	
Low washer fluid level	
Check AdvTrac	
AdvTrac OFF T/C ON	
Check suspension	
Suspension switched off	
Check fuel cap	

**CHECK PARK ASSIST.** Displayed when the transmission is in R (Reverse).

**PRNDL ERROR NO PARK ASSIST.** Displayed when the transmission is in R (Reverse) and the Backup Aid is disabled. Refer to *Backup Aid* in this section to enable.

**ADVTRAC ON.** Displayed when the AdvanceTrac™ is ON.

**ADVTRAC OFF.** Displayed when the AdvanceTrac™ is OFF.

**POWER LIFTGATE OFF.** Displayed when the Power liftgate is turned OFF.

**DOOR AJAR.** Displayed when a door is not completely closed.

**LIFTGATE AJAR.** Displayed when the liftgate or liftgate glass is not completely closed.

**CHECK ENGINE TEMPERATURE.** Displayed when the engine coolant is overheating. Stop the vehicle as soon as safely possible, turn off the engine and let it cool. Check the coolant and coolant level. Refer to *Engine coolant* in the *Maintenance and specifications* chapter. If the warning stays on or continues to come on, contact your dealer as soon as safely possible.

**REDUCED ENGINE POWER.** Displayed when the engine is overheating. Stop the vehicle as soon as safely possible, turn off the engine. If the warning stays on or continues to come on, contact your dealer as soon as safely possible.

**STOP ENGINE SAFELY.** Displayed when the engine is overheating. Stop the vehicle as soon as safely possible, turn off the engine. If the warning stays on or continues to come on, contact your dealer as soon as safely possible.



## Driver Controls

**WARNING-TIRE VERY LOW.** Displayed when one or more tires have very low pressure. When this warning message is displayed, a warning chime will sound reminding you to stop the vehicle as soon as safely possible and check your tires for proper pressure, leaks and damage. Refer to *Servicing your tires* in the *Maintenance and specifications* chapter.

**TIRE PRESSURE SYSTEM FAULT.** Displayed when a tire pressure monitoring system is malfunctioning. If the warning stays on or continues to come on, have the system checked by your dealer.

**CHECK TIRE PRESSURE.** Displayed when any of the tire pressures are low. Refer to *Checking the tire pressure* in the *Maintenance and specifications* chapter.

**TIRE PRESSURE SENSOR FAULT.** Displayed when a tire pressure sensor is malfunctioning. If the warning stays on or continues to come on, have the system checked by your dealer.

**LOW FUEL LEVEL.** Displayed as an early reminder of a low fuel condition.

**CHECK CHARGING SYSTEM.** Displayed when the electrical system is not maintaining proper voltage. If you are operating electrical accessories when the engine is idling at a low speed, turn off as many of the electrical loads as soon as possible. If the warning stays on or comes on when the engine is operating at normal speeds, have the electrical system checked as soon as possible.

**LOW BRAKE FLUID LEVEL.** Indicates the brake fluid level is low and the brake system should be inspected immediately. Refer to *Checking and adding brake fluid* in the *Maintenance and specifications* chapter.

**LOW OIL PRESSURE.** Displayed when the engine oil pressure is low. If this warning message is displayed, check the level of the engine oil. Refer to *Engine oil* in the *Maintenance and specifications* chapter for information about adding engine oil. If the oil level is OK and this warning persists, shut down the engine immediately and contact your dealership for service.

**LOW WASHER FLUID LEVEL.** Indicates the washer fluid reservoir is less than one quarter full. Check the washer fluid level. Refer to *Windshield washer fluid* in the *Maintenance and specifications* chapter.

## Driver Controls

**CHECK ADVTRAC.** Displayed when the AdvanceTrac<sup>™</sup> system is not operating properly. If this message is displayed on the message center the AdvanceTrac<sup>™</sup> system may be partially operable. If this warning stays on while the engine is running, contact your dealer for service as soon as possible. For further information, refer to *AdvanceTrac<sup>™</sup> stability enhancement system* in the *Driving* chapter.

**ADVTRAC OFF T/C ON.** Displayed on 4x4 vehicles only when 4x4 Low Range is selected. In this mode, the stability enhancement portion of the AdvanceTrac<sup>™</sup> is disabled, but the traction enhancement feature remains enabled. For further information, refer to *AdvanceTrac<sup>™</sup> stability enhancement system* in the *Driving* chapter.

**CHECK SUSPENSION.** Displayed when the air suspension system is not operating properly. If this message is displayed while driving, pull off the road as soon as safely possible. For more information, refer to *Air suspension* in the *Driving* chapter.

**SUSPENSION SWITCHED OFF.** Displayed when the air suspension switch is in the OFF position. For more information, refer to *Air suspension* in the *Driving* chapter.

**CHECK FUEL CAP.** Displayed when the fuel filler cap is not properly installed. Check the fuel filler cap for proper installation. Refer to *Fuel filler cap* in the *Maintenance and specifications* chapter.

**DATA ERR.** These messages indicate improper operation of the vehicle network communication between electronic modules.

- Fuel computer
- Charging system
- Door sensor
- Washer fluid
- Brake fluid
- Compass
- Outside temperature
- Engine sensor

Contact your dealer as soon as possible if these messages occur on a regular basis.

## Driver Controls

### CENTER CONSOLE

Your vehicle may be equipped with a variety of console features. These include:

- Utility compartment
- Cupholders
- Coin holder slots
- Tissue box holder
- Rear audio controls
- Power point



Use only soft cups in the cupholder. Hard objects can injure you in a collision.

### Cell phone use

The use of Mobile Communications Equipment has become increasingly important in the conduct of business and personal affairs. However, drivers must not compromise their own or others' safety when using such equipment. Mobile Communications can enhance personal safety and security when appropriately used, particularly in emergency situations. Safety must be paramount when using mobile communications equipment to avoid negating these benefits.

Mobile Communication Equipment includes, but is not limited to cellular phones, pagers, portable email devices, in vehicle communications systems, telematics devices and portable two-way radios.



A driver's first responsibility is the safe operation of the vehicle. The most important thing you can do to prevent a crash is to avoid distractions and pay attention to the road. Wait until it is safe to operate Mobile Communications Equipment.

### Rear center console features (if equipped)

The rear center console incorporates the following features:

- utility compartment
- cupholders

## Driver Controls

### POSITIVE RETENTION FLOOR MAT

Position the driver floor mat so that the eyelet is over the pointed end of the retention post and rotate forward to lock in. Make sure that the mat does not interfere with the operation of the accelerator or the brake pedal. To remove the floor mat, reverse the installation procedure.

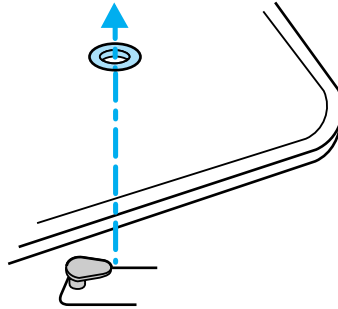

### POWER LIFTGATE (IF EQUIPPED)

The liftgate can be operated by the following:

- overhead console button
- key fob button
- outside release handle

The Overhead console button and Key fob features will only operate the liftgate with the vehicle in P (Park).



**WARNING:** Make sure all persons are clear of the power liftgate area before using the power liftgate control.



Keep keys out of reach of children. Do not allow children to play near an open or moving power liftgate.

Do not open the liftgate in a garage or other enclosed area with a low ceiling. If the liftgate is raised the liftgate could be damaged against a low ceiling.

#### **To open the liftgate from the Overhead console:**

Refer to *Overhead controls* in this section.

#### **To open the liftgate with the Key fob:**

Refer to *Remote Entry System* in the *Locks and security* chapter.

## Driver Controls

### To open the liftgate with outside release handle (manual actuation):

1. To open, unlock the liftgate with the key fob or power door unlock control.
2. Pull and release the liftgate handle to engage the power assist feature.
3. To open the rear window, push the button on the left side of the liftgate handle above the license plate.

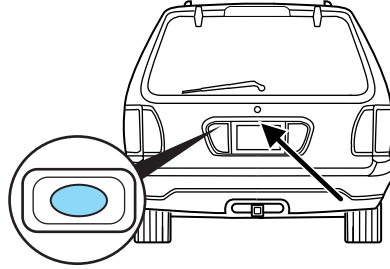

**Note:** Continued upward force after unlatching may activate the obstacle detection feature and stop the power system. For the best performance allow the power system to open the liftgate after releasing the handle.

4. To close, pull down the liftgate a few inches to activate power closing. Closing the gate rapidly or more than a few inches may activate the obstacle detection feature and stop the power system.

**Note:** You will need to wait 2 seconds after opening the liftgate to begin manually closing the power liftgate.

### Obstacle detection

The power liftgate system is equipped with an obstacle detection feature.

If the power liftgate is closing, the system is designed to reverse to full open when it encounters a solid obstacle. Once the obstacle is removed, the liftgate can be closed under power.

If the power liftgate is opening, the system is designed to stop when it encounters a solid obstacle. If the liftgate stops below the half open position, you will need to close and fully latch the liftgate manually. Normal operation can then be resumed.

### Resetting the power liftgate:

The power liftgate may not operate under these conditions. If any of these conditions occur, the power liftgate must be reset.

- a low voltage or dead battery
- disconnected battery
- the liftgate has been left open, or in the partially latched position, for more than six (6) hours.

To reset the power liftgate:

1. Manually close and fully latch the liftgate.

## Driver Controls

2. Power open the liftgate by using the keyfob or overhead console button.
3. Once the liftgate is fully open, close the liftgate using the keyfob or overhead console button.

**Note:** If the power liftgate system is turned <OFF> in the message center, the system can not be activated with any switches or with the liftgate handle. The system will need to be turned <ON> for any power operation to occur.

### Liftgate ajar signal

If the liftgate or liftgate glass are not fully latched, you will receive a “LIFTGATE AJAR” message on the instrument panel. If you see this message, check both the liftgate glass and liftgate door to insure they are fully latched.



Make sure the liftgate is closed to prevent exhaust fumes from being drawn into the vehicle. If you must drive with the liftgate open, keep the vents open so outside air comes into the vehicle.

### MANUAL LIFTGATE (IF EQUIPPED)

To open the rear window, push the button on the left side of the liftgate handle above the license plate.

To open the liftgate, pull the liftgate handle.

- Do not open the liftgate or liftgate glass in a garage or other enclosed area with a low ceiling. If the liftgate glass is raised and the liftgate is also opened, both liftgate and glass could be damaged against a low ceiling.
- Do not leave the liftgate or liftgate glass open while driving. Doing so could cause serious damage to the liftgate and its components as well as allowing carbon monoxide to enter the vehicle.

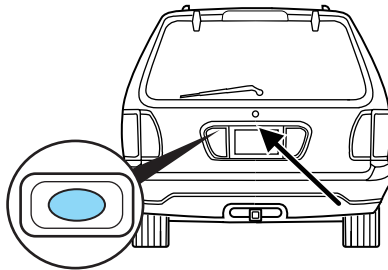

Make sure that the liftgate door and/or window are closed to prevent exhaust fumes from being drawn into the vehicle. This will also prevent passengers and cargo from falling out. If you must drive with the liftgate door or window open, keep the vents open so outside air comes into the vehicle.

## Driver Controls

### LUGGAGE RACK

The rear cross-bar can be adjusted to fit the item being carried. The front cross-bar does not move.

To adjust cross-bar position:

1. Loosen the thumbscrews at both ends of the rear cross-bar.
2. Slide the cross-bar to the desired location.
3. Tighten the thumbscrews at both ends of the cross-bar.

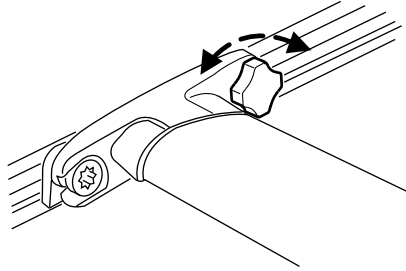

Load luggage at the front cross-bar and adjust the rear cross-bar as necessary.

- Do not exceed 90.7 kg (200 lb) of luggage if the weight is placed directly on the cross-bars.
- Do not exceed 68 kg (150 lb) if the weight is resting directly on the roof.

## Locks and Security

### KEYS

The key operates all locks on your vehicle. In case of loss, replacement keys are available from your dealer.

You should always carry a second key with you in a safe place in case you require it in an emergency.

Refer to *SecuriLock<sup>™</sup> Passive Anti-Theft System* for more information.

### POWER DOOR LOCKS

If the door does not unlock when the control is pressed, refer to the *Power door lock disable feature* section in this chapter.

Press control to unlock all doors.

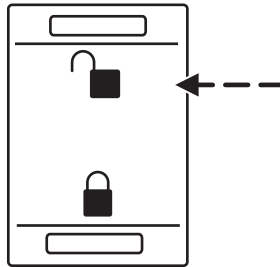

Press control to lock all doors.

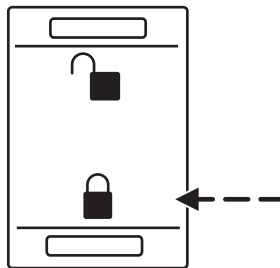



## Locks and Security

### Childproof door locks

When these locks are set, the rear doors cannot be opened from the inside. The rear doors can be opened from the outside when the doors are unlocked.

The childproof locks are located on rear edge of each rear door and must be set separately for each door. Setting the lock for one door will not automatically set the lock for both doors.

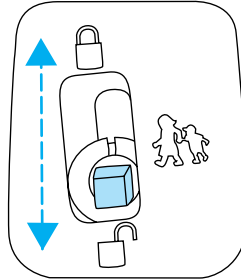

Move lock control up to engage the childproof lock. Move control down to disengage childproof locks.

### REMOTE ENTRY SYSTEM

This device complies with part 15 of the FCC rules and with RS-210 of Industry Canada. Operation is subject to the following two conditions: (1) This device may not cause harmful interference, and (2) This device must accept any interference received, including interference that may cause undesired operation.

**Changes or modifications not expressly approved by the party responsible for compliance could void the user's authority to operate the equipment.**

The remote entry system allows you to lock or unlock all vehicle doors and liftgate and open the liftgate window without a key.

The remote entry lock/unlock feature operates in any ignition position. The liftgate glass features operate as long as the vehicle's speed is less than 5 km/h (3 mph). The panic feature operates with the key in the 1 (OFF/LOCK) or 2 (ACCESSORY) position.

If there is any potential remote keyless entry problem with your vehicle, ensure **ALL** remote entry transmitters are brought to the dealership, to aid in troubleshooting.

### Unlocking the doors/liftgate

Press this control to unlock the driver's door. The interior lamps will illuminate with the ignition is in the 1 (OFF/LOCK) position.

## Locks and Security

- 4-button remote

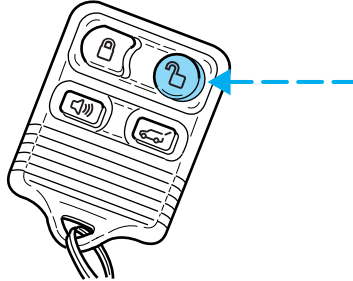

- 5-button remote

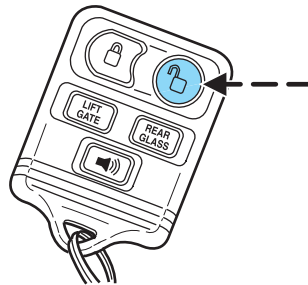

Press the control a second time within three seconds to unlock all doors and liftgate.

### Locking the doors/liftgate

Press this control to lock all doors and liftgate.

To confirm all doors are closed and locked, press the control a second time within three seconds and the horn will chirp.

- 4-button remote

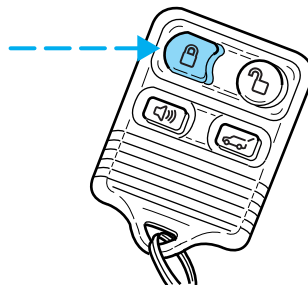

## Locks and Security

- **5-button remote**

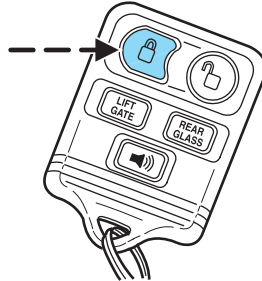

If any of the doors or liftgate are ajar, the horn will make two quick chirps, reminding you to properly close all doors.

### Unlocking the liftgate window

Press the control to unlatch the liftgate window.

- **4-button remote**

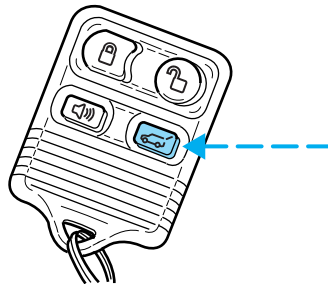

- **5-button remote**

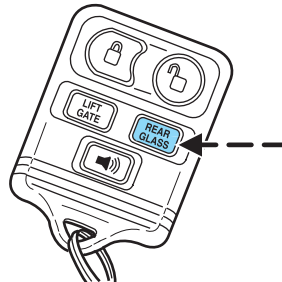

## Locks and Security

### Opening the power liftgate (if equipped)

Press the control twice to fully unlatch and open the liftgate.

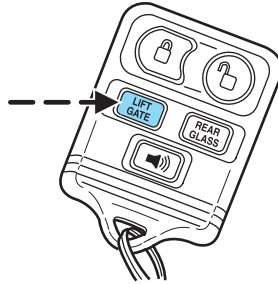

Make sure all persons are clear of the liftgate area before using power liftgate control.

In order to fully lower and latch the liftgate, press the control twice.

If the liftgate stops mid travel, it may have detected an obstacle. Check to ensure the liftgate swing zone is free from obstruction and reset the power assist by manually closing the liftgate. Normal operation can then be resumed.



Make sure the liftgate is closed to prevent exhaust fumes from being drawn into the vehicle. This will also prevent passengers and cargo from falling out. If you must drive with the liftgate open, keep the vents open so outside air comes into the vehicle.

### Sounding a panic alarm

Press this control to activate the alarm.

The personal panic alarm will cycle the horn and parking lamps on/off.

## Locks and Security

- **4-button remote**

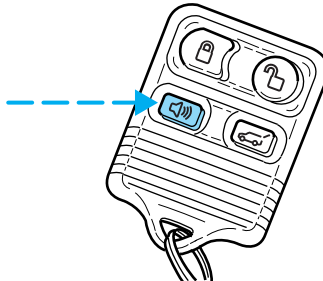

- **5-button remote**

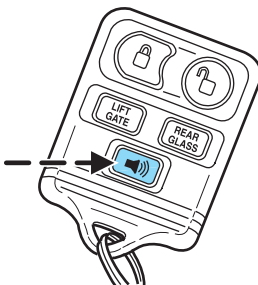

To deactivate the alarm, press the control again or turn the ignition to the 2 (ACCESSORY) or 3 (ON) position.

### Memory feature

The remote entry system can also control the memory feature.

Press the control once to unlock the driver's door. Pressing the control will automatically move the seat, rearview mirrors, and adjustable pedals to the desired memory position (the memory position corresponds to the transmitter being used).

- **4-button remote**

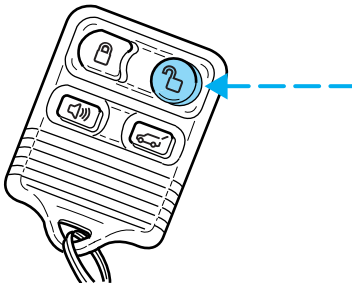

## Locks and Security

- **5-button remote**

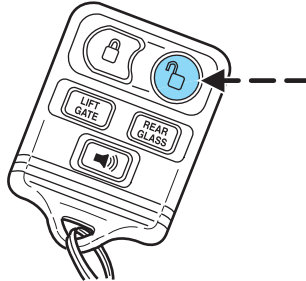

### **Activating the memory feature**

To activate this feature:

1. Position the seat, rearview mirror, and adjustable pedals to the positions you desire.
2. Press the SET control on the driver's door panel.
3. Within 5 five seconds, press one control on the remote transmitter and then press the 1 or 2 control on the driver's door panel to which you would like to associate with Driver 1 or Driver 2 positions.
4. Repeat this procedure for another remote transmitter if desired.

### **Deactivating the memory seat feature**

To deactivate this feature:

1. Press the SET control on the driver's door panel.
2. Within 5 five seconds, press any control on the remote transmitter which you would like to deactivate and then press the SET control on the driver's door panel.

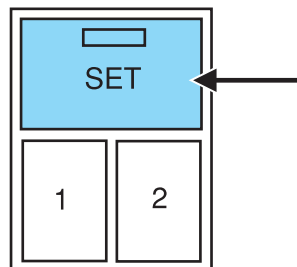

3. Repeat this procedure for another remote transmitter if desired.

### **Replacing the battery**

The remote entry transmitter uses one coin type three-volt lithium battery CR2032 or equivalent.

## Locks and Security

To replace the battery:

1. Twist a thin coin between the two halves of the remote entry transmitter near the key ring. **DO NOT TAKE THE RUBBER COVER AND CIRCUIT BOARD OFF THE FRONT HOUSING OF THE REMOTE ENTRY TRANSMITTER.**

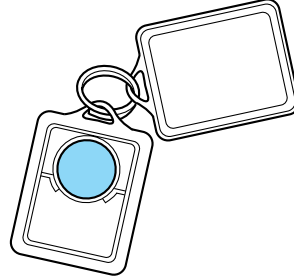

2. Do not wipe off any grease on the battery terminals on the back surface of the circuit board.

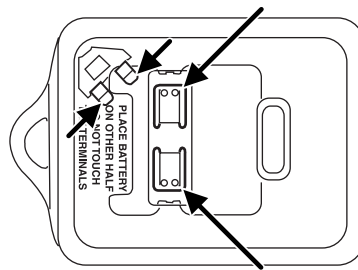

3. Remove the old battery. **Note:** Please refer to local regulations when disposing of transmitter batteries.

4. Insert the new battery. Refer to the diagram inside the remote entry transmitter for the correct orientation of the battery. Press the battery down to ensure that the battery is fully seated in the battery housing cavity.

5. Snap the two halves back together.

**Note:** Replacement of the battery will **not** cause the remote transmitter to become deprogrammed from your vehicle. The remote transmitter should operate normally after battery replacement.

### Replacing lost transmitters

If a remote transmitter has been lost and you would like to remove it from the vehicle's memory, or you would like to purchase additional remote transmitters and have them programmed to your vehicle:

- Take **all** your vehicle's transmitters to your dealer for programming, or
- Perform the programming procedure yourself.

## Locks and Security

- 4-button remote

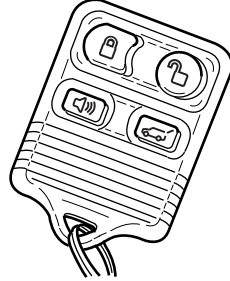

- 5-button remote

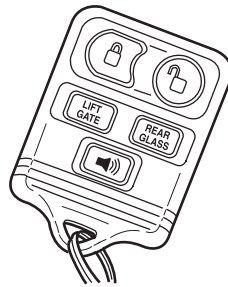

### **Programming remote transmitters**

It is necessary to have **all** (maximum of four — original and/or new) of your remote transmitters available prior to beginning this procedure. To program the transmitters yourself:

- Unlock all doors using the power door lock/unlock control. Insert a key in the ignition and turn from the 1 (OFF/LOCK) to the 3 (ON) position and cycle between 1 (OFF/LOCK) and 3 (ON) eight times in rapid succession (within 10 seconds) with the eighth turn ending in the 3 (ON) position. The locks will cycle between unlocked and locked to confirm that the programming mode has been entered.
- Within 20 seconds, program a remote transmitter by pressing any button on a transmitter. **Note:** If more than 20 seconds pass before pressing a remote transmitter button, the programming mode will exit and the procedure will have to be repeated.

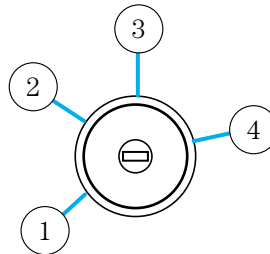



## Locks and Security

- Repeat the previous step to program additional remote transmitters.
- When you have completed programming the remote transmitters, turn the ignition to the 1 (OFF/LOCK) position or wait 20 seconds.

### **Illuminated entry**

The lamps illuminate when the remote entry system is used to unlock the door(s).

The system automatically turns off after 25 seconds or when the ignition is turned to the 2 (ACCESSORY) or 3 (ON) position. The dome lamp control must **not** be set to the off position for the illuminated entry system to operate.

The inside lights will not turn off if:

- they have been turned on with the dimmer control, or
- any door is open.

The battery saver will shut off the interior lamps 30 minutes after the ignition has been turned to the 1 (OFF/LOCK) position.

### **Autolock**

This feature automatically locks all vehicle doors when:

- all doors, liftgate and liftgate window are closed,
- the engine is running and
- you shift into any gear putting the vehicle in motion.

### **Relock**

The autolock feature repeats when:

- any door (except the driver's) is opened then closed while the engine is running, and
- you put the vehicle in motion.

### **Deactivating/activating the autolock feature**

For vehicles equipped with a message center, the autolock feature may be deactivated/activated by selecting the autolock function (accessed by pressing the SETUP control). Press the RESET control to turn the autolock function on or off. Refer to the *Message center* section in the *Driver Controls* chapter for additional information.

For vehicles not equipped with a message center, the feature may be deactivated by taking your vehicle to an authorized Ford dealer.

## Locks and Security

### Power door lock disable feature

This feature will help protect your vehicle from unauthorized entry.

The UNLOCK function on the power door control will not operate with the ignition in the 1 (OFF/LOCK) position and twenty seconds after the doors are closed and electronically locked by the remote entry transmitter, key pad, or power door control (if pressed while the door was open).

The UNLOCK function will operate again after you unlock the vehicle using the remote entry transmitter or key pad, turn the ignition to the 3 (ON) position, or open the door from inside of the vehicle.

### Deactivating/activating power door lock disable feature

This feature may be deactivated/activated by an authorized dealer.

### KEYLESS ENTRY SYSTEM

With the keyless entry keypad, you can:

- lock or unlock the vehicle doors without using the key,
- release the liftgate glass,
- enable or disable the autolock function, and
- add or delete a 5–digit personal user code.

Your vehicle has a factory set 5–digit code that operates the keyless entry system. You can also program your own 5–digit personal entry code. The factory-set code is located:

- on the owner's wallet card in the glove compartment,
- at your dealer,
- or on the module located under the right-hand side of the instrument panel, adjacent to the passenger compartment fuse panel.

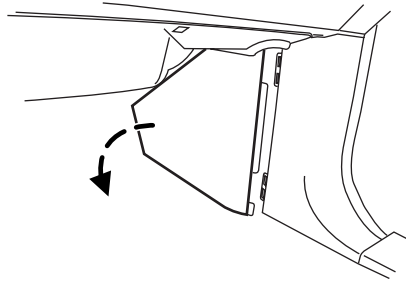

## Locks and Security

**Note:** The 5–digit code (e.g. 12345) will be in large, **BOLD** numbers on the module label.

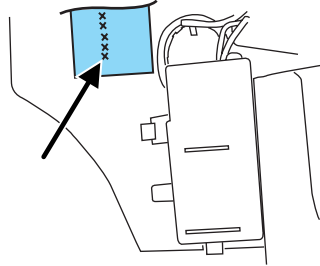

When pressing the controls on the keyless entry keypad, press the middle of the controls to ensure a good activation.

### Programming your own personal entry code

To program your own code:

6. Enter the factory set code (keypad will illuminate when pressed).
7. Press the 1 • 2 control within five seconds of Step 1.

8. Enter your personal 5–digit code. Enter each digit within five seconds of previous one.

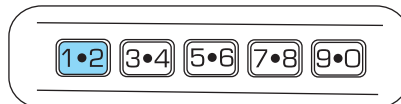

9. After the code is entered, the locks will cycle, confirming that the new code has been set.

Do not set a code that includes five of the same number or presents them in sequential order. Thieves can easily figure out these types of codes.

Your personal code does not replace the permanent code that the dealership gave you. You can use either code to unlock your vehicle. If a second personal code is entered, the module will erase the first personal code in favor of the new code.

If you wish to erase your personal code, use the following instructions:

1. Enter the factory set code.
2. Press the 1 • 2 control and release.

The system will now only respond to the factory set code.

## Locks and Security

### Anti-scan feature

If the wrong code has been entered 7 times (35 consecutive button presses), the keypad is disabled for one minute and the keypad lamp will flash during this time. **Note:** Pressing 7 • 8 and the 9 • 0 simultaneously during this one minute period will still lock the vehicle.

The anti-scan feature will turn off after one minute of keypad inactivity.

### Unlocking and locking the doors, liftgate and liftgate window using keyless entry

**To unlock the driver's door,** enter the factory set 5-digit code or your personal code. Each number must be pressed within five seconds of each other. The interior lamps will illuminate.

**To unlock all doors and liftgate,** press the 3 • 4 control within five seconds.

**To open the liftgate window,** press the 5 • 6 control within five seconds.

**To lock all doors, liftgate and liftgate window,** press the 7 • 8 and the 9 • 0 at the same time. **Note:** The driver's door must be closed. You **do not** need to enter the keypad code first.

### Activating/deactivating autolock with the keyless entry system

1. Turn the ignition to the the 1 (OFF/LOCK) position.
2. Close all the doors, the liftgate and liftgate window.
3. Enter the 5-digit entry code
4. Press and hold the 7 • 8. While holding the 7 • 8 press the 3 • 4.
5. Release the 3 • 4.
6. Release the 7 • 8.

The user should receive a **horn chirp** to indicate the system has been disabled or a chirp followed by a honk to indicate the system has been enabled.

### SECURILOCK™ PASSIVE ANTI-THEFT SYSTEM

SecuriLock™ passive anti-theft system is an engine immobilization system. This system is designed to prevent the engine from being started unless a **coded key programmed to your vehicle** is used.

The SecuriLock™ passive anti-theft system is not compatible with non-Ford aftermarket remote start systems. Use of these systems may result in vehicle starting problems and a loss of security protection.

## Locks and Security

### THEFT INDICATOR

The theft indicator is the flashing red indicator located on the dash panel.

- When the ignition is in the 1 (OFF/LOCK) position, the indicator will flash once every 2 seconds to indicate the SecuriLock<sup>™</sup> system is functioning as a theft deterrent.
- When the ignition is in the 3 (ON) position, the indicator will glow for 3 seconds to indicate normal system functionality.

If a problem occurs with the SecuriLock<sup>™</sup> system, the indicator will flash rapidly or glow steadily when the ignition is in the 3 (ON) position. If this occurs, the vehicle should be taken to an authorized dealer for service.

### Automatic arming

The vehicle is armed immediately after switching the ignition to the 1 (OFF/LOCK) position.

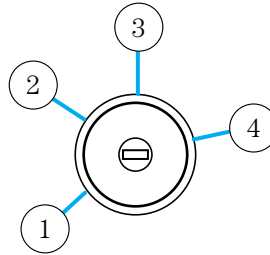

### Automatic disarming

Switching the ignition to the 3 (ON) position with a **coded key** disarms the vehicle.

### Key information

Your vehicle is supplied with **two coded keys**. Only a **coded key** will start your vehicle. Spare coded keys can be purchased from your dealership. Your dealership can program your key or you can “do it yourself.” Refer to the *Programming spare keys* section in this chapter.

The following items may prevent the vehicle from starting:

- Large metallic objects
- Electronic devices on the key chain that can be used to purchase gasoline or similar items
- A second key on the same key ring as the **coded key**

## Locks and Security

If any of these items are present, you need to keep these objects from touching the **coded key** while starting the engine. These objects and devices cannot damage the **coded key**, but can cause a momentary “no start” condition if they are too close to the key during engine start. If a problem occurs, turn ignition to the OFF position and restart the engine with all other objects on the key ring held away from the ignition key. Check to make sure the **coded key** is an approved Lincoln **coded key**.

If your keys are lost or stolen you will need to do the following:

- Use your spare key to start the vehicle, or
- Have your vehicle towed to a dealership or a locksmith. The key codes will need to be erased from your vehicle and new key codes will need to be re-coded.

Replacing coded keys can be very costly and you may want to store an extra programmed key away from the vehicle in a safe place to prevent an unforeseen inconvenience.

The correct **coded key** must be used for your vehicle. The use of the wrong type of **coded key** may lead to a “no start” condition.

**If an unprogrammed key is used in the ignition it will cause a “no start” condition.**

### Programming spare keys

A maximum of eight keys can be coded to your vehicle. Only SecuriLock<sup>™</sup> keys can be used. To program a **coded key** yourself, you will need two previously programmed **coded keys** (keys that already operate your vehicle’s engine) and the new unprogrammed key(s) readily accessible for timely implementation of each step in the procedure.

If two previously programmed coded keys are not available, you must bring your vehicle to your dealership to have the spare coded key(s) programmed.

Please read and understand the entire procedure before you begin.

## Locks and Security

1. Insert the first previously programmed **coded key** into the ignition and turn the ignition from the 1 (OFF/LOCK) to the 3 (ON) position [maintain ignition in 3 (ON) for at least three seconds, but no more than ten seconds].

2. Turn ignition from 3 (ON) back to the 1 (OFF/LOCK) position in order to remove the first **coded key** from the ignition.

3. Within ten seconds of removing the first **coded key**, insert the second previously programmed **coded key** into the ignition and turn the ignition from the 1 (OFF/LOCK) to the 3 (ON) position [maintain ignition in 3 (ON) for at least three seconds but no more than ten seconds].

4. Turn the ignition from the 3 (ON) back to 1 (OFF/LOCK) position in order to remove the second **coded key** from the ignition.

5. Within 10 seconds of removing the second **coded key**, insert the new unprogrammed key (new key/valet key) into the ignition and turn the ignition from the 1 (OFF/LOCK) to the 3 (ON) position [maintain ignition in 3 (ON) for at least three seconds, but no more than ten seconds]. This step will program your new key to a coded key.

6. To program additional new unprogrammed key(s), repeat this procedure from Step 1.

If successful, the new coded key(s) will start the vehicle's engine and the theft indicator will illuminate for three seconds and then go out.

If not successful, the new coded key(s) will not start the vehicle's engine and the theft indicator will flash on and off and you may repeat Steps 1 through 5. If failure repeats, bring your vehicle to your dealership to have the new spare key(s) programmed.

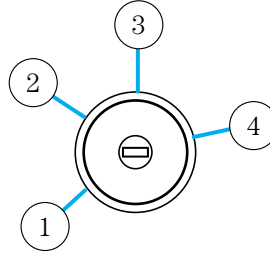

## Seating and Safety Restraints

### SEATING

#### Front row adjustable head restraints

Your vehicle's seats are equipped with four-way adjustable head restraints. The purpose of these head restraints is to help limit head motion in the event of a rear collision. To properly adjust your head restraints, lift the head restraint so that it is located directly behind your head or as close to that position as possible. Refer to the following illustration to raise and lower the head restraints.

The head restraints can be moved forward and backward as well as up and down.

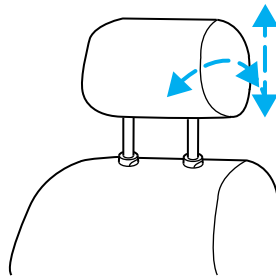

Push control to lower head restraint.

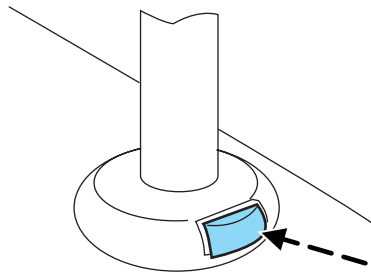

#### Using the power lumbar support

The power lumbar control is located on the outboard side of the seat.

Press the forward side of the control to adjust firmness.

Press the rear side of the control to adjust softness.

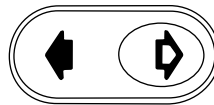



## Seating and Safety Restraints

### Adjusting the front power seat



Never adjust the driver's seat or seatback when the vehicle is moving.



Do not pile cargo higher than the seatbacks to avoid injuring people in a collision or sudden stop.



Always drive and ride with your seatback upright and the lap belt snug and low across the hips.



Reclining the seatback can cause an occupant to slide under the seat's safety belt, resulting in severe personal injuries in the event of a collision.

The control is located on the outboard side of the seat cushion.

Press the front or rear portion to tilt the seat.

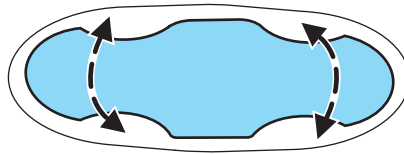

Press the control to move the seat forward, backward, up or down.

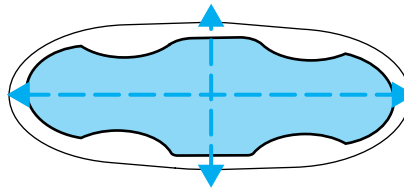

## Seating and Safety Restraints

Press the control to recline the seatback forward or rearward.

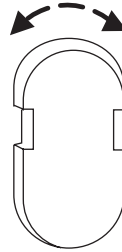

### Memory seats/rearview mirrors/adjustable pedals

This system allows automatic positioning of the driver seat, outside rearview mirrors, and adjustable pedals to two programmable positions.

The memory seat control is located on the driver door.

- To program position one, move the driver seat, rearview mirrors, and adjustable pedals to the desired position. Press the SET control. The SET control indicator light will briefly illuminate. While the light is illuminated, press control 1.
- To program position two, repeat the previous procedure using control 2.

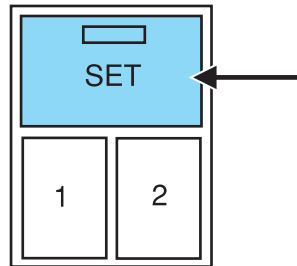

A position can only be recalled when the transmission gearshift is in Park. A memory position may be programmed at any time.

The memory positions can also be recalled when you press your remote entry transmitter UNLOCK control.

To program the memory function to a specific remote entry transmitter, refer to *Remote entry system* in the *Locks and security chapter*.

## Seating and Safety Restraints

### CLIMATE CONTROLLED SEATS (if equipped)

The controls for the climate controlled seats are located on the center console.

To operate the climate controlled seats the engine must be running.

- Push the icon on the button to activate cooled seats. A blue light illuminates on the button. Push the icon again to disengage.



- Push the icon on the button to activate heated seats. A red light illuminates on the button. Push the icon again to disengage.



#### In heat mode:

- Rotate the thumbwheel to select the desired heat level from 1 (MIN) to 5 (MAX).



#### In cool mode:

- Rotate the thumbwheel to select the desired cooling level from 1 (MIN) to 5 (MAX). When setting **1** is selected, the seat(s) will provide vent cooling only (same temperature as cabin air).



Allow five minutes for the temperature level to stabilize.

The climate controlled seats turn off after approximately 15 minutes in heat mode and approximately 30 minutes in cool mode to minimize unintended drain on the vehicle's power supply.

#### Climate controlled seats air filter replacement

The climate controlled seat system includes an air filter that has to be replaced periodically. Refer to the *Scheduled Maintenance Guide* for more information.

## Seating and Safety Restraints

- There is a filter located under both front seats.

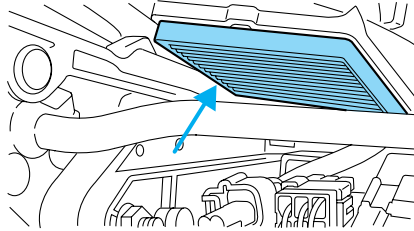

- It can be accessed from the second row seat. Move the front seat all the way forward and up to ease access.



To remove climate controlled seat air filter:

- Remove key from ignition.
- Push on the outside rigid edge of the air filter at the center and rotate downward once tab is released.
- Remove filter.

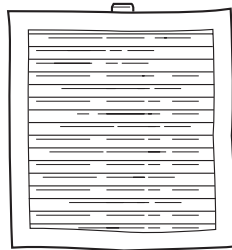
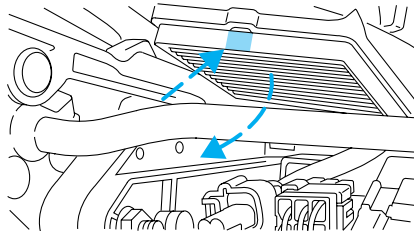

To install climate controlled seat air filter:

## Seating and Safety Restraints

- First, position the filter in its housing making sure that the far forward end is all the way up in the housing. Then push in on the center of the outside edge of the filter and rotate up into the housing until it clips into position.

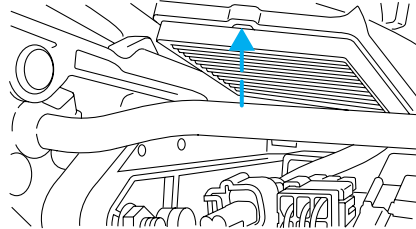

### REAR SEATS

#### Second row seats

Your vehicle's second row outboard seating positions are equipped with head restraints which are vertically adjustable. The purpose of these head restraints is to help limit head motion in the event of a rear collision. To properly adjust your head restraints, lift the head restraint so that it is located directly behind your head or as close to that position as possible.

The head restraints can be raised by lifting. To lower the head restraint, press the release button.

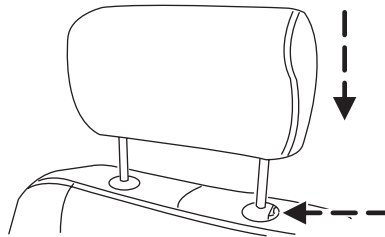

If the head restraint becomes detached, replace the notched bar into the bezel while holding the release button.

#### Second row folding seat system

Ensure that no objects such as books, purses or briefcases are on the floor in front of the second row seats or on the seat cushion before folding them down. Ensure that the head restraints are lowered.

Move the front passenger seat forward so that the second row seat headrest clears the front seat.

For assistance, refer to the label located on the side of the seat cushion.

## Seating and Safety Restraints

### **Adjusting the 2nd row outboard seat for E-Z Entry**

The 2nd row outboard seats allow for easier entry and exit to and from the 3rd row seat.

To enter the 3rd row seat:

1. Locate the handle on the side of the seat, lifting it to release the seatback.

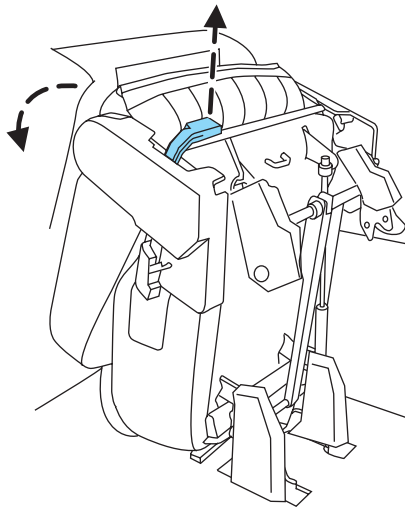
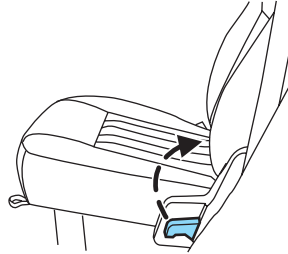

2. Pull up on the handle located at the back of the seat. The seat will flip forward.

## Seating and Safety Restraints

3. To return the seat to a seating position, push down on the seat until the seat is latched to the floor.

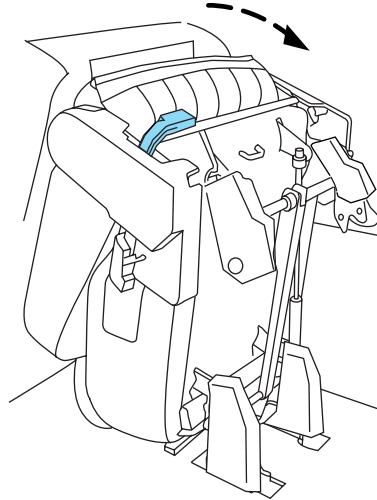

4. With the seat in the flat back position, lift up on the lever located on the side of the seat cushion. This will allow the seat back to be lifted to the upright locked position.

5. Lift the seatback to the upright position.



Always latch the vehicle seat to the floor, whether the seat is occupied or empty. If not latched, the seat may cause injury during a sudden stop.

### **Folding 40% seat system to full lowered load floor position**



Use caution when folding the seatback to the flat back position as the system will move forward when you lift the release handle.

## Seating and Safety Restraints

1. Locate the handle on the side of the seat, lifting it to release the seatback.
2. Ensure that the seat back is locked in the down position by applying pressure to the seat back.

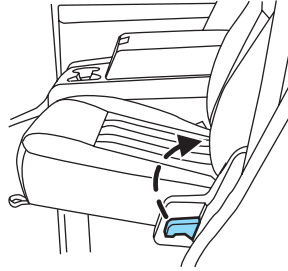

3. Locate the latch strap at the front of the seat and pull to release the seat into a kneel down load floor position. A moderate force may be required to move the seat forward and down.

Once the second row seats are in the down position, the front seats may be readjusted.

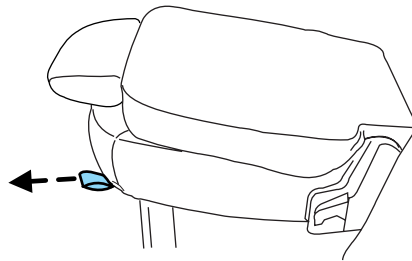

### Returning to the upright position from full lowered load floor position

The seatback cannot be returned to the upright position until the seat is returned from the kneel down position. To return the seat to the upright position:

From the full lowered position:

1. Lift and pull the seat rearward until the latch is engaged.

**Do not attempt to un-latch the rear floor hooks while the seat is in the kneel down position.**

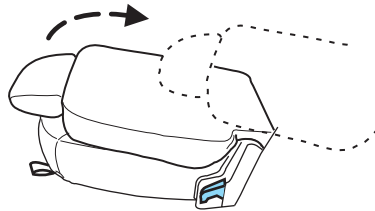



## Seating and Safety Restraints

 The rear latch hooks must be properly engaged with the floor striker. Position the rear legs of the seat over the floor strikers and engage.

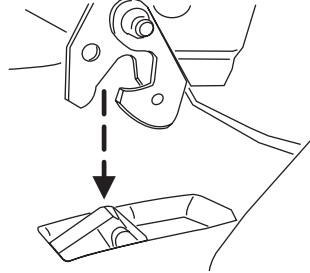

2. With the seat in the flat back

position, lift up on the lever located on the side of the seat cushion. This will allow the seat back to be lifted to the upright locked position.

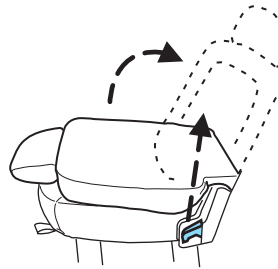

### Folding the 20% seat system (if equipped)

1. Locate the release strap located between the front cushion and the seat back, and pull the strap to release the folding seat latch.

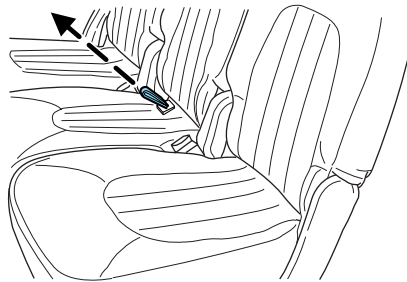

**To prevent possible damage to the seat or safety belts, ensure that the safety belts are not buckled when moving the seat to the load floor position.**

## Seating and Safety Restraints

2. With the latch released the seatback can be lowered into the load floor position.

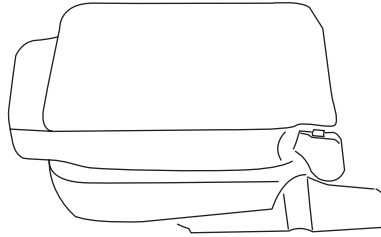

3. To return the seat to the upright position, lift the seatback until the latch is fully engaged.

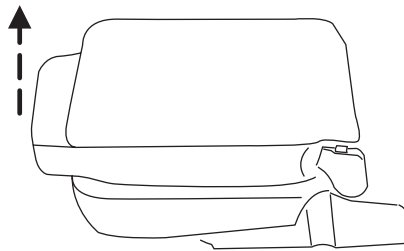

### **Adjusting the second row 20% seat (if equipped)**

Lift the handle to move the seat forward or backward.

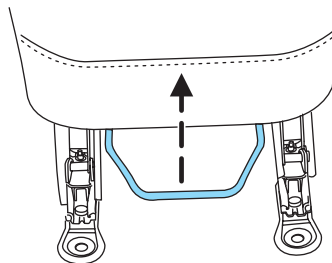

**Note:** This seat can be moved forward to keep a child in a child restraint close to the front seat occupants. The seat should be moved to the full rearward position when it is occupied by older children or adults.

## Seating and Safety Restraints

### Reclining the second row 40% seatback

Locate the release handle located on the outboard side of the seat cushion and lift gently to allow the seatback to be adjusted to the desired location.

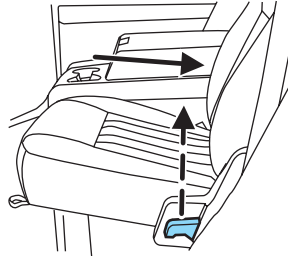

Reclining the seatback can cause an occupant to slide under the seat's safety belt, resulting in severe personal injuries in the event of a collision.

### Third row seats

Ensure that no objects such as books, purses or briefcases are on the floor in front of the third row seats or on the seat cushion before lowering them. Ensure that the head restraints are lowered.

### **Third row adjustable head restraints**

Your vehicle's third row outboard seating positions are equipped with head restraints which are vertically adjustable. The purpose of these head restraints is to help limit head motion in the event of a rear collision. To properly adjust your head restraints, lift the head restraint so that it is located directly behind your head or as close to that position as possible.

## Seating and Safety Restraints

The head restraints can be moved up and down.

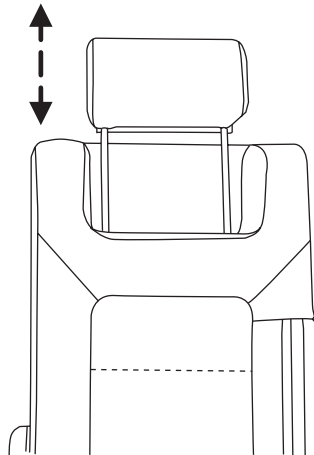

Push control to lower head restraint.

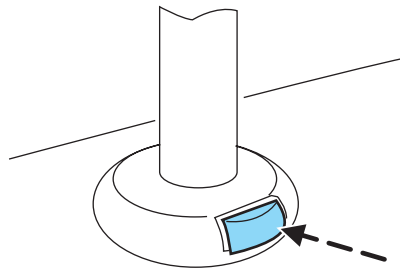

### ***Folding down the third row seat to the load floor***

**To prevent possible damage to the seat or safety belts, ensure that the safety belts are not buckled when moving the seat to the load floor position.**

## Seating and Safety Restraints

Pull up on the handle located behind the seatback while pushing the seatback forward and down into the seat cushion.

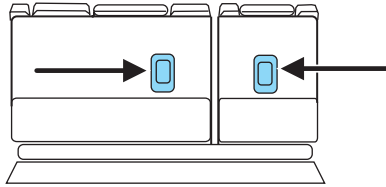

To return the seatback to its original position lift the seatback until it latches into place.

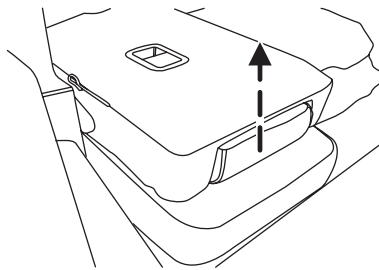

### **Third row power folding seat (if equipped)**

The control buttons are located on the right-hand rear quarter trim panel (accessible from the liftgate area).

Push the bottom portion of the control button to lower the desired seatback.

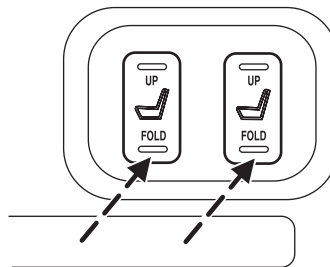

## Seating and Safety Restraints

Push the top of the control button to return the seatback to its original position.

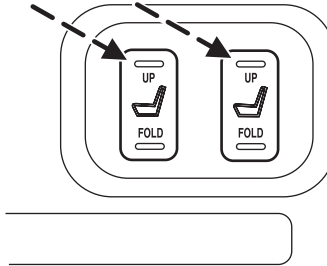

**The power folding seats are designed to stall within 1–10 seconds of encountering an obstruction when opening or closing. Should this occur, remove the obstruction and wait approximately 1–4 minutes for the seat motor to reset.**

**The power fold down seats will operate for 30 minutes after the ignition switch is in Off. The transmission must be in P (park), and the liftgate, or liftgate glass must be open. Similar to the Battery Saver feature, the power 3rd row seat will be disabled 30 minutes after turning the vehicle off. If the power 3rd row seat is disabled after 30 minutes, the seat can be enabled by opening any door, pressing the unlock key on the key fob, pressing any keyless keypad button, or turning the ignition key.**

### SAFETY RESTRAINTS

#### Personal Safety System

The Personal Safety System provides an improved overall level of frontal crash protection to front seat occupants and is designed to help further reduce the risk of air bag-related injuries. The system is able to analyze different occupant conditions and crash severity before activating the appropriate safety devices to help better protect a range of occupants in a variety of frontal crash situations.

Your vehicle's Personal Safety System consists of:

- Driver and passenger dual-stage air bag supplemental restraints.
- Front safety belts with pretensioners, energy management retractors, and safety belt usage sensors.
- Driver's seat position sensor.
- Front crash severity sensor.
- Restraints Control Module (RCM).

## Seating and Safety Restraints

- Restraint system warning light and back-up tone.
- The electrical wiring for the air bags, crash sensor(s), safety belt pretensioners, front safety belt usage sensors, driver seat position sensor, and indicator lights.

### ***How does the personal safety system work?***

The Personal Safety System can adapt the deployment strategy of your vehicle's safety devices according to crash severity and occupant conditions. A collection of crash and occupant sensors provides information to the Restraints Control Module (RCM). During a crash, the RCM activates the safety belt pretensioners and/or either one or both stages of the dual-stage air bag supplemental restraints based on crash severity and occupant conditions.

The fact that the pretensioners or air bags did not activate for both front seat occupants in a collision does not mean that something is wrong with the system. Rather, it means the Personal Safety System determined the accident conditions (crash severity, belt usage, etc.) were not appropriate to activate these safety devices. Front air bags are designed to activate only in frontal and near-frontal collisions, not rollovers, side-impacts, or rear-impacts unless the collision causes sufficient longitudinal deceleration.

### ***Driver and passenger dual-stage air bag supplemental restraints***

The dual-stage air bags offer the capability to tailor the level of air bag inflation energy. A lower, less forceful energy level is provided for more common, moderate-severity impacts. A higher energy level is used for the most severe impacts. Refer to *Air bag Supplemental Restraints* section in this chapter.

### ***Front crash severity sensor***

The front crash severity sensor enhances the ability to detect the severity of an impact. Positioned up front, it provides valuable information early in the crash event on the severity of the impact. This allows your Personal Safety System to distinguish between different levels of crash severity and modify the deployment strategy of the dual-stage air bags and safety belt pretensioners.

### ***Driver's seat position sensor***

The driver's seat position sensor allows your Personal Safety System to tailor the deployment level of the driver dual-stage air bag based on seat position. The system is designed to help protect smaller drivers sitting close to the driver air bag by providing a lower air bag output level.

## Seating and Safety Restraints

### **Front safety belt usage sensors**

The front safety belt usage sensors detect whether or not the driver and front outboard passenger safety belts are fastened. This information allows your Personal Safety System to tailor the air bag deployment and safety belt pretensioner activation depending upon safety belt usage. Refer to *Safety Belt* section in this chapter.

### **Front safety belt pretensioners**

The front outboard safety belt pretensioners are designed to tighten the safety belts of the driver and front outboard passenger firmly against the occupant's body during a collision. This maximizes the effectiveness of the safety belts and helps properly position the occupant relative to the air bag to improve protection. The safety belt pretensioners can be either activated alone or, if the collision is of sufficient severity, together with the air bags.

### **Front safety belt energy management retractors**

The front outboard safety belt energy management retractors allow webbing to be pulled out of the retractor in a gradual and controlled manner in response to the occupant's forward momentum. This helps reduce the risk of force-related injuries to the occupant's chest by limiting the load on the occupant. Refer to *Safety Belt* section in this chapter.

### **Determining if the Personal Safety System is operational**

The Personal Safety System uses a warning light in the instrument cluster or a back-up tone to indicate the condition of the system. Refer to the *Warning Light* section in the *Instrument Cluster* chapter. Routine maintenance of the Personal Safety System is not required.

The Restraints Control Module (RCM) monitors its own internal circuits and the circuits for the air bag supplemental restraints, crash sensor(s), safety belt pretensioners, front safety belt buckle sensors, and the driver seat position sensor. In addition, the RCM also monitors the restraints warning light in the instrument cluster. A difficulty with the system is indicated by one or more of the following:

- The warning light will either flash or stay lit.
- The warning light will not illuminate immediately after the ignition is turned on.
- A series of five beeps will be heard. The tone pattern will repeat periodically until the problem and warning light are repaired.

200



## Seating and Safety Restraints

If any of these things happen, even intermittently, have the Personal Safety System serviced at your dealership or by a qualified technician immediately. Unless serviced, the system may not function properly in the event of a collision.

### Safety restraints precautions



Always drive and ride with your seatback upright and the lap belt snug and low across the hips.



To reduce the risk of injury, make sure children sit in the back seat where they can be properly restrained.



Never let a passenger hold a child on his or her lap while the vehicle is moving. The passenger cannot protect the child from injury in a collision.



All occupants of the vehicle, including the driver, should always properly wear their safety belts, even when an air bag supplemental restraint system (SRS) is provided.



It is extremely dangerous to ride in a cargo area, inside or outside of a vehicle. In a collision, people riding in these areas are more likely to be seriously injured or killed. Do not allow people to ride in any area of your vehicle that is not equipped with seats and safety belts. Be sure everyone in your vehicle is in a seat and using a safety belt properly.



In a rollover crash, an unbelted person is significantly more likely to die than a person wearing a safety belt.



Each seating position in your vehicle has a specific safety belt assembly which is made up of one buckle and one tongue that are designed to be used as a pair. 1) Use the shoulder belt on the outside shoulder only. Never wear the shoulder belt under the arm. 2) Never swing the safety belt around your neck over the inside shoulder. 3) Never use a single belt for more than one person.

## Seating and Safety Restraints



Always transport children 12 years old and under in the back seat and always properly use appropriate child restraints.



Safety belts and seats can become hot in a vehicle that has been closed up in sunny weather; they could burn a small child. Check seat covers and buckles before you place a child anywhere near them.

### Combination lap and shoulder belts

1. Insert the belt tongue into the proper buckle (the buckle closest to the direction the tongue is coming from) until you hear a snap and feel it latch. Make sure the tongue is securely fastened in the buckle.

- Front and rear seats

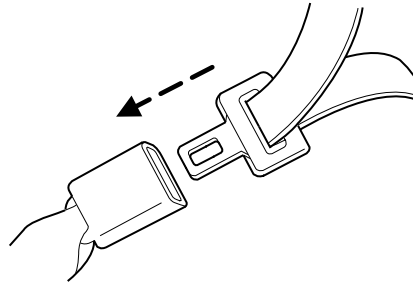

2. To unfasten, push the release button and remove the tongue from the buckle.

- Front and rear seats

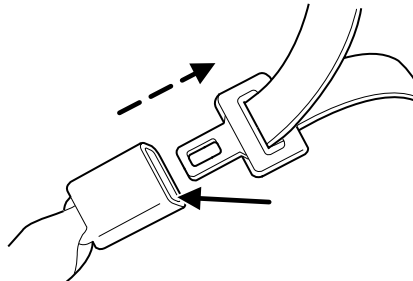

All safety restraints in the vehicle are combination lap and shoulder belts. All of the passenger combination lap and shoulder belts have two types of locking modes described below:

### Vehicle sensitive mode

This is the normal retractor mode, which allows free shoulder belt length adjustment to your movements and locking in response to vehicle

## Seating and Safety Restraints

movement. For example, if the driver brakes suddenly or turns a corner sharply, or the vehicle receives an impact of approximately 8 km/h (5 mph) or more, the combination safety belts will lock to help reduce forward movement of the driver and passengers.

### Automatic locking mode

In this mode, the shoulder belt is pre-locked. The belt will still retract to remove any slack in the shoulder belt.

The automatic locking mode is not available on the driver safety belt.

### When to use the automatic locking mode

- **Anytime** a child safety seat (except a booster) is installed in the vehicle. Children 12 years old and under should be properly restrained in the rear seat whenever possible. Refer to *Safety restraints for children* or *Safety seats for children* later in this chapter.

### How to use the automatic locking mode

1. Buckle the combination lap and shoulder belt.

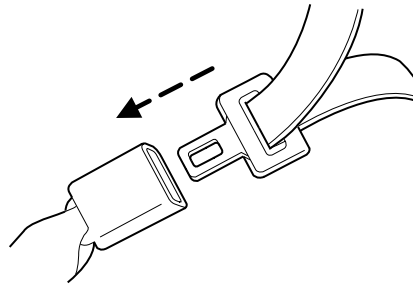

2. Grasp the shoulder portion and pull downward until the entire belt is pulled out.



3. Allow the belt to retract. As the belt retracts, you will hear a clicking sound. This indicates the safety belt is now in the automatic locking mode.

## Seating and Safety Restraints

### ***How to disengage the automatic locking mode***

Unbuckle the combination lap and shoulder belt and allow it to retract completely to disengage the automatic locking mode and return to the vehicle sensitive (emergency) locking mode.



After any vehicle collision, the combination lap and shoulder belt system at all passenger seating positions must be checked by a qualified technician to verify that the “automatic locking retractor” feature for child seats is still functioning properly, in addition to other checks for proper seat belt system function.



**BELT AND RETRACTOR ASSEMBLY MUST BE REPLACED** if the safety belt assembly “automatic locking retractor” feature or any other safety belt function is not operating properly. In addition, all safety belts should be checked for proper function. Failure to replace the belt and retractor assembly could increase the risk of injury in collisions.

### **Safety belt pretensioner**

Your vehicle is equipped with safety belt pretensioners at the driver and right front passenger seating positions.

The safety belt pretensioner removes some slack from the safety belt system at the start of a crash. The safety belt pretensioner uses the same crash sensor system as the front airbags and Safety Canopy™ system. When the safety belt pretensioner deploys, the lap and shoulder belt are tightened.

When the Safety Canopy™ system and/or the front airbags are activated, the safety belt pretensioners for the driver and right front passenger seating positions will be activated when the respective seatbelt is properly buckled.



The driver and the right front passenger seat belt system (including retractors, buckles and height adjusters) must be replaced if the vehicle is involved in a collision that results in deployment of front air bags or Safety Canopy™ and safety belt pretensioners.

Refer to the *Safety belt maintenance* section in this chapter.

## Seating and Safety Restraints

### Front and second row safety belt height adjustment

Your vehicle has safety belt height adjustments for the driver, right front passenger and second row outboard passengers. Adjust the height of the shoulder belt so the belt rests across the middle of your shoulder.

To lower the shoulder belt height, push the button and slide the height adjuster down. To raise the height of the shoulder belt, push the button and slide the height adjuster up. Pull down on the height adjuster to make sure it is locked in place.

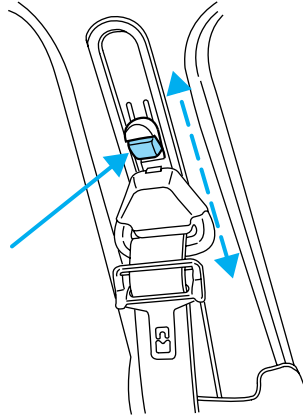

 Position the safety belt height adjusters so that the belt rests across the middle of your shoulder. Failure to adjust the safety belt properly could reduce the effectiveness of the seat belt and increase the risk of injury in a collision.

### Safety belt warning light and indicator chime

The safety belt warning light illuminates in the instrument cluster and a chime sounds to remind the occupants to fasten their safety belts.

## Seating and Safety Restraints

### Conditions of operation

If...	Then...
The driver safety belt is not buckled before the ignition switch is turned to the ON position...	The safety belt warning light illuminates 1-2 minutes and the warning chime sounds 4-8 seconds.
The driver safety belt is buckled while the indicator light is illuminated and the warning chime is sounding...	The safety belt warning light and warning chime turn off.
The driver safety belt is buckled before the ignition switch is turned to the ON position...	The safety belt warning light and indicator chime remain off.

### BeltMinder™

The BeltMinder™ feature is a supplemental warning to the safety belt warning function. This feature provides additional reminders to the driver that the driver's safety belt is unbuckled by intermittently sounding a chime and illuminating the safety belt warning lamp in the instrument cluster.

If...	Then...
The driver's safety belt is not buckled approximately 5 seconds after the safety belt warning light has turned off...	The BeltMinder™ feature is activated - the safety belt warning light illuminates and the warning chime sounds for 6 seconds every 30 seconds, repeating for approximately 5 minutes or until safety belt is buckled.
The driver's safety belt is buckled while the safety belt indicator light is illuminated and the safety belt warning chime is sounding...	The BeltMinder™ feature will not activate.
The driver's safety belt is buckled before the ignition switch is turned to the ON position...	The BeltMinder™ feature will not activate.

The purpose of the BeltMinder™ is to remind occasional wearers to wear safety belts all of the time.

## Seating and Safety Restraints

The following are reasons most often given for not wearing safety belts:  
(All statistics based on U.S. data)

Reasons given...	Consider...
“Crashes are rare events”	<b>36 700 crashes occur every day.</b> The more we drive, the more we are exposed to “rare” events, even for good drivers. <i>1 in 4 of us will be seriously injured in a crash during our lifetime.</i>
“I’m not going far”	<b>3 of 4</b> fatal crashes occur within <b>25</b> miles of home.
“Belts are uncomfortable”	We design our safety belts to enhance comfort. If you are uncomfortable - try different positions for the safety belt upper anchorage and seatback which should be as upright as possible; this can improve comfort.
“I was in a hurry”	<b>Prime time for an accident.</b> BeltMinder™ reminds us to take a few seconds to buckle up.
“Seat belts don’t work”	<b>Safety belts</b> , when used properly, <b>reduce risk of death</b> to front seat occupants by <b>45% in cars</b> , and by <b>60% in light trucks</b> .
“Traffic is light”	<b>Nearly 1 of 2 deaths occur in single-vehicle crashes</b> , many when no other vehicles are around.
“Belts wrinkle my clothes”	Possibly, but a serious crash can do much more than wrinkle your clothes, particularly if you are unbelted.
“The people I’m with don’t wear belts”	Set the example, teen deaths occur 4 times more often in vehicles with TWO or MORE people. Children and younger brothers/sisters imitate behavior they see.
“I have an air bag”	Air bags offer greater protection when used with safety belts. Frontal airbags are not designed to inflate in rear and side crashes or rollovers.
“I’d rather be thrown clear”	Not a good idea. <b>People</b> who are <b>ejected are 40 times more likely to DIE</b> . Safety belts help prevent ejection, WE CAN’T “PICK OUR CRASH”.

## Seating and Safety Restraints



Do not sit on top of a buckled safety belt to avoid the Belt Minder™ chime. Sitting on the safety belt will increase the risk of injury in an accident. To disable (one-time) or deactivate the Belt Minder™ feature please follow the directions stated below.

### **One time disable**

Any time the safety belt is buckled and then unbuckled during an ignition ON cycle, BeltMinder™ will be disabled for that ignition cycle only.

### **Deactivating/activating the BeltMinder™ feature**

*Read steps 1 - 9 thoroughly before proceeding with the deactivation/activation programming procedure.*

The BeltMinder™ feature can be deactivated/activated by performing the following procedure:

Before following the procedure, make sure that:

- The parking brake is set
- The gearshift is in P (Park) (automatic transmission)
- The ignition switch is in the OFF position
- All vehicle doors are closed
- The driver's safety belt is unbuckled
- The parklamps/headlamps are in OFF position (If vehicle is equipped with Autolamps, this will not affect the procedure.)



To reduce the risk of injury, do not deactivate/activate the BeltMinder™ feature while driving the vehicle.

1. Turn the ignition switch to the RUN (or ON) position. (DO NOT START THE ENGINE)
2. Wait until the safety belt warning light turns off. (Approximately 1–2 minutes)
  - Steps 3–5 must be completed within 60 seconds or the procedure will have to be repeated.
3. Buckle then unbuckle the safety belt three times, ending with the safety belt unbuckled. This can be done before or during BeltMinder™ warning activation.
4. Turn on the parklamps/headlamps, turn off the parklamps/headlamps.

208



## Seating and Safety Restraints

5. Buckle then unbuckle the safety belt three times, ending with the safety belt unbuckled.
  - After step 5 the safety belt warning light will be turned on for three seconds.
6. Within seven seconds of the safety belt warning light turning off, buckle then unbuckle the safety belt.
  - This will disable BeltMinder™ if it is currently enabled, or enable BeltMinder if it is currently disabled.
7. Confirmation of disabling BeltMinder™ is provided by flashing the safety belt warning light four times per second for three seconds.
8. Confirmation of enabling BeltMinder™ is provided by flashing the safety belt warning light four times per second for three seconds, followed by three seconds with the safety belt warning light off, then followed by flashing the safety belt warning light four times per second for three seconds again.
9. After receiving confirmation, the deactivation/activation procedure is complete.

### Safety belt extension assembly

If the safety belt is too short when fully extended, there is a 20 cm (8 inch) safety belt extension assembly that can be added (part number 611C22). This assembly can be obtained from your dealer at no cost.

Use only extensions manufactured by the same supplier as the safety belt. Manufacturer identification is located at the end of the webbing on the label. Also, use the safety belt extension only if the safety belt is too short for you when fully extended.



Do not use extensions to change the fit of the shoulder belt across the torso.

### Safety belt maintenance

Inspect the safety belt systems periodically to make sure they work properly and are not damaged. Inspect the safety belts to make sure there are no nicks, tears or cuts. Replace if necessary. All safety belt assemblies, including retractors, buckles, front seat belt buckle assemblies, buckle support assemblies (slide bar-if equipped), shoulder belt height adjusters, shoulder belt guide on seatback (if equipped), child safety seat LATCH and tether anchors, and attaching hardware, should be inspected after a collision. Ford Motor Company recommends that all

## Seating and Safety Restraints

safety belt assemblies in use in vehicles involved in a collision be replaced. However, if the collision was minor and a qualified technician finds that the belts do not show damage and continue to operate properly, they do not need to be replaced. Safety belt assemblies not in use during a collision should also be inspected and replaced if either damage or improper operation is noted.

Refer to *Interior* in the *Cleaning* chapter.

### AIR BAG SUPPLEMENTAL RESTRAINT SYSTEM (SRS)

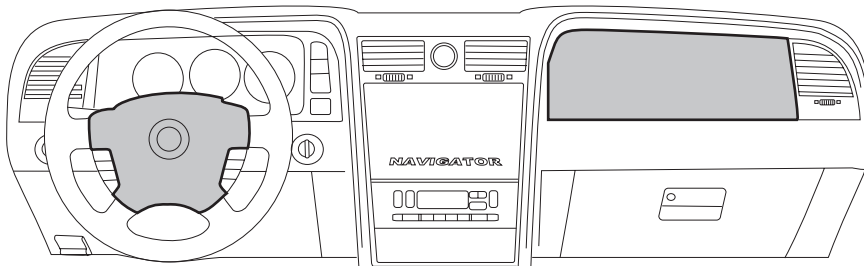

#### Important SRS precautions

The SRS is designed to work with the safety belt to help protect the driver and right front passenger from certain upper body injuries. Air bags DO NOT inflate slowly; there is a risk of injury from a deploying air bag.

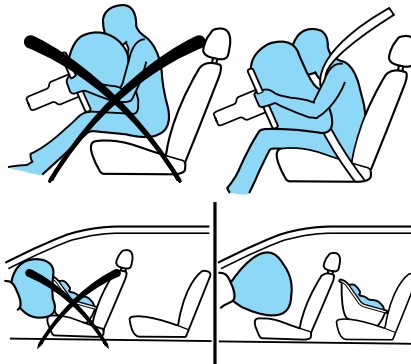

All occupants of the vehicle, including the driver, should always properly wear their safety belts, even when an air bag supplemental restraint system (SRS) is provided.

## Seating and Safety Restraints



Always transport children 12 years old and under in the back seat and always properly use appropriate child restraints.



The National Highway Traffic Safety Administration (NHTSA) recommends a minimum distance of at least 25 cm (10 inches) between an occupant's chest and the driver air bag module.



Never place your arm over the air bag module as a deploying air bag can result in serious arm fractures or other injuries.

To properly position yourself away from the air bag:

- Move your seat to the rear as far as you can while still reaching the pedals comfortably.
- Recline the seat slightly one or two degrees from the upright position.



Do not put anything on or over the air bag module. Placing objects on or over the air bag inflation area may cause those objects to be propelled by the air bag into your face and torso causing serious injury.



Do not attempt to service, repair, or modify the air bag supplemental restraint systems or its fuses. See your Ford or Lincoln Mercury dealer.



The front passenger air bag is not designed to offer protection to an occupant in the center front seating position.



Modifying or adding equipment to the front end of the vehicle (including frame, bumper, front end body structure and tow hooks) may affect the performance of the air bag system, increasing the risk of injury. Do not modify the front end of the vehicle.



Additional equipment may affect the performance of the air bag sensors increasing the risk of injury. Please refer to the *Body Builders Layout Book* for instructions about the appropriate installation of additional equipment.

## Seating and Safety Restraints

### Children and air bags

Children must always be properly restrained. Accident statistics suggest that children are safer when properly restrained in the rear seating positions than in the front seating position. Failure to follow these instructions may increase the risk of injury in a collision.

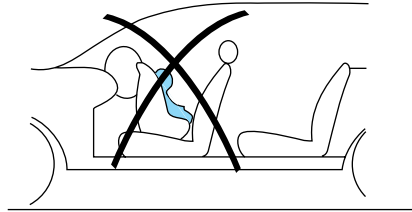

Air bags can kill or injure a child in a child seat.

**NEVER** place a rear-facing child seat in front of an active air bag. If you must use a forward-facing child seat in the front seat, move the seat all the way back.

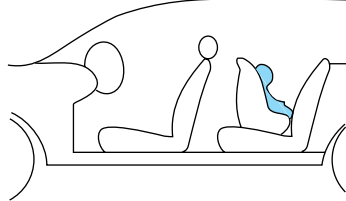

### How does the air bag supplemental restraint system work?

The air bag SRS is designed to activate when the vehicle sustains longitudinal deceleration sufficient to cause the sensors to close an electrical circuit that initiates air bag inflation.

The fact that the air bags did not inflate in a collision does not mean that something is wrong with the system. Rather, it means the forces were not of the type sufficient to cause activation. The driver and passenger airbags are designed to inflate in frontal and near-frontal collisions, not rollover, side-impact, or rear-impacts unless the collision causes sufficient longitudinal deceleration.

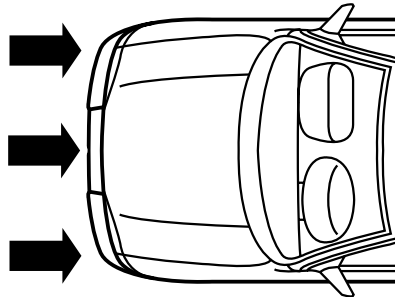

## Seating and Safety Restraints

The air bags inflate and deflate rapidly upon activation. After air bag deployment, it is normal to notice a smoke-like, powdery residue or smell the burnt propellant. This may consist of cornstarch, talcum powder (to lubricate the bag) or sodium compounds (e.g., baking soda) that result from the combustion process that inflates the air bag. Small amounts of sodium hydroxide may be present which may irritate the skin and eyes, but none of the residue is toxic.



While the system is designed to help reduce serious injuries, contact with a deploying air bag may also cause abrasions, swelling or temporary hearing loss. Because air bags must inflate rapidly and with considerable force, there is the risk of death or serious injuries such as fractures, facial and eye injuries or internal injuries, particularly to occupants who are not properly restrained or are otherwise out of position at the time of air bag deployment. Thus, it is extremely important that occupants be properly restrained as far away from the air bag module as possible while maintaining vehicle control.



Several air bag system components get hot after inflation. Do not touch them after inflation.



If the air bag has deployed, **the air bag will not function again and must be replaced immediately.** If the air bag is not replaced, the unrepaired area will increase the risk of injury in a collision.

The SRS consists of:

- driver and passenger air bag modules (which include the inflators and air bags),
- one or more impact and safing sensors and diagnostic monitor (RCM),
- a readiness light and tone
- the electrical wiring which connects the components.

The RCM (restraints control module) monitors its own internal circuits and the supplemental air bag electrical system wiring (including the

## Seating and Safety Restraints

impact sensors, the system wiring, the air bag system readiness light, the air bag back up power and the air bag ignitors).

### Determining if the system is operational

The SRS uses a readiness light in the instrument cluster or a tone to indicate the condition of the system. Refer to *Air bag readiness* section in the *Instrument Cluster* chapter. Routine maintenance of the air bag is not required.

A difficulty with the system is indicated by one or more of the following:

- The readiness light will either flash or stay lit.
- The readiness light will not illuminate immediately after ignition is turned on.
- A series of five beeps will be heard. The tone pattern will repeat periodically until the problem and/or light are repaired.



If any of these things happen, even intermittently, have the SRS serviced at your dealership or by a qualified technician immediately. Unless serviced, the system may not function properly in the event of a collision.

### Safety Canopy™ system

 Do not place objects or mount equipment on or near the headliner at the siderail that may come into contact with a deploying Safety Canopy™. Failure to follow these instructions may increase the risk of personal injury in the event of a collision.

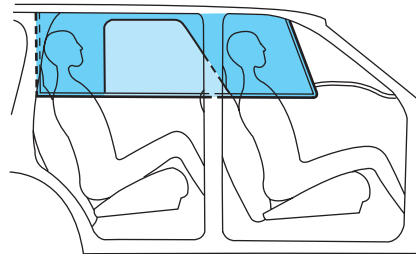

 Do not lean your head on the door. The Safety Canopy™ could injure you as it deploys from the headliner.

## Seating and Safety Restraints

 Do not attempt to service, repair, or modify the Safety Canopy™ system, its fuses, the A, B, or C pillar trim, or the headliner on a vehicle containing a Safety Canopy™. See your Ford or Lincoln Mercury dealer.

 All occupants of the vehicle including the driver should always wear their safety belts even when an air bag SRS and Safety Canopy™ system is provided.

 To reduce risk of injury, do not obstruct or place objects in the deployment path of the inflatable Safety Canopy™.

### **How does the Safety Canopy™ system work?**

The design and development of the Safety Canopy™ system included recommended testing procedures that were developed by a group of automotive safety experts known as the Side Air Bag Technical Working Group. These recommended testing procedures help reduce the risk of injuries related to the deployment of side airbags (including the Safety Canopy™).

The Safety Canopy™ system consists of the following:

- An inflatable nylon curtain with a gas generator concealed behind the headliner and above the doors (one on each side of vehicle).
- A headliner designed to flex open above the side doors to allow Safety Canopy™ deployment.
- The same warning light, electronic control and diagnostic unit as used for the front airbags.

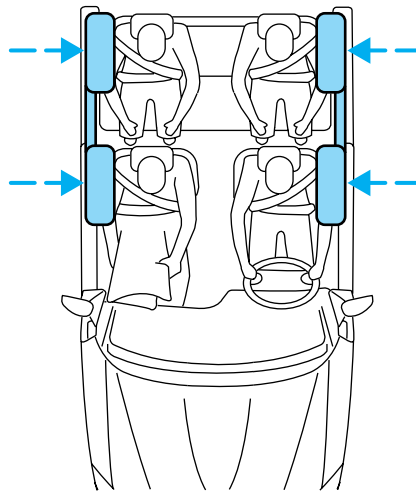

## Seating and Safety Restraints

- Two crash sensors mounted in the front doors (one on each side).
- Two crash sensors located at the c-pillar behind the rear doors (one on each side).
- Rollover sensor in the restraints control module (RCM).

The Safety Canopy™ system, in combination with seat belts, can help reduce the risk of severe injuries in the event of a significant side impact collision or rollover event.

Children 12 years old and under should always be properly restrained in the second or third row seats. The Safety Canopy™ will not interfere with children restrained using a properly installed child or booster seat because it is designed to inflate downward from the headliner above the doors along the side window opening.

The Safety Canopy™ system is designed to activate when the vehicle sustains lateral deceleration sufficient to cause the side crash sensor to close an electrical circuit that initiates Safety Canopy™ inflation or when a certain likelihood of a rollover event is detected by the rollover sensor.

The Safety Canopy™ is mounted to roof side-rail sheet metal, behind the headliner, above the first and second row seats. In certain lateral collisions or rollover events, the Safety Canopy™ system will be activated, regardless of which seats are occupied. The Safety Canopy™ is designed to inflate between the side window area and occupants to further enhance protection provided in side impact collisions and rollover events.

The fact that the Safety Canopy™ did not activate in a collision does not mean that something is wrong with the system. Rather, it means the forces were not of the type sufficient to cause activation. The Safety Canopy™ is designed to inflate in certain side impact collisions or rollover events, not in rear impact, frontal or near-frontal collisions, unless the collision causes sufficient lateral deceleration or rollover likelihood.



## Seating and Safety Restraints



Several Safety Canopy™ system components get hot after inflation. Do not touch them after inflation.

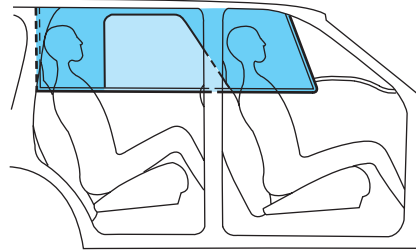

If the Safety Canopy™ system has deployed, **the Safety Canopy™ will not function again unless replaced. The Safety Canopy™ system (including the A, B and C pillar trim) must be inspected and serviced by a qualified technician in accordance with the vehicle service manual.** If the Safety Canopy™ is not replaced, the unrepaired area will increase the risk of injury in a collision.

### ***Determining if the system is operational***

The SRS uses a readiness light in the instrument cluster or a tone to indicate the condition of the system. Refer to the *Air bag readiness* section in the *Instrument Cluster* chapter. Routine maintenance of the air bag is not required.

Any difficulty with the system is indicated by one or more of the following:

- The readiness light (same light as for front air bag system) will either flash or stay lit.
- The readiness light will not illuminate immediately after ignition is turned on.
- A series of five beeps will be heard. The tone pattern will repeat periodically until the problem and light are repaired.

If any of these things happen, even intermittently, have the SRS serviced at your dealership or by a qualified technician immediately. Unless serviced, the system may not function properly in the event of a collision or rollover event.

### **Disposal of air bags and air bag equipped vehicles (including pretensioners)**

See your local dealership or qualified technician. Air bags **MUST BE** disposed of by qualified personnel.

## Seating and Safety Restraints

### SAFETY RESTRAINTS FOR CHILDREN

See the following sections for directions on how to properly use safety restraints for children. Also see *Air bag supplemental restraint system (SRS)* in this chapter for special instructions about using air bags.

#### Important child restraint precautions

You are required by law to use safety restraints for children in the U.S. and Canada. If small children (generally children who are four years old or younger and who weigh 18 kg [40 lbs] or less) ride in your vehicle, you must put them in safety seats made especially for children. Many states require that children use approved booster seats until they are eight years old. Check your local and state or provincial laws for specific requirements regarding the safety of children in your vehicle. When possible, always place children under age 12 in the rear seat of your vehicle. Accident statistics suggest that children are safer when properly restrained in the rear seating positions than in the front seating position.



Never let a passenger hold a child on his or her lap while the vehicle is moving. The passenger cannot protect the child from injury in a collision.

Always follow the instructions and warnings that come with any infant or child restraint you might use.

#### Children and safety belts

If the child is the proper size, restrain the child in a safety seat.

Children who are too large for child safety seats (as specified by your child safety seat manufacturer) should always wear safety belts.

Follow all the important safety restraint and air bag precautions that apply to adult passengers in your vehicle.

If the shoulder belt portion of a combination lap and shoulder belt can be positioned so it does not cross or rest in front of the child's face or neck, the child should wear the lap and shoulder belt. Moving the child closer to the center of the vehicle may help provide a good shoulder belt fit.



Do not leave children, unreliable adults, or pets unattended in your vehicle.

## Seating and Safety Restraints

### **Child booster seats**

Children outgrow a typical convertible or toddler seat when they weigh 40 pounds and are around 4 years of age. Although the lap/shoulder belt will provide some protection, these children are still too small for lap/shoulder belts to fit properly, which could increase the risk of serious injury.

To improve the fit of both the lap and shoulder belt on children who have outgrown child safety seats, Ford Motor Company recommends use of a belt-positioning booster.

Booster seats position a child so that safety belts fit better. They lift the child up so that the lap belt rests low across the hips and the knees bend comfortably. Booster seats also make the shoulder belt fit better and more comfortably for growing children.

### **When children should use booster seats**

Children need to use booster seats from the time they outgrow the toddler seat until they are big enough for the vehicle seat and lap/shoulder belt to fit properly. Generally this is when they weigh about 80 lbs (about 8 to 12 years old).

Booster seats should be used until you can answer YES to ALL of these questions:

- Can the child sit all the way back against the vehicle seat back with knees bent comfortably at the edge of the seat without slouching?

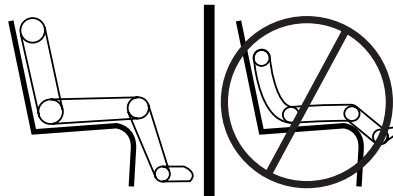

- Does the lap belt rest low across the hips?
- Is the shoulder belt centered on the shoulder and chest?
- Can the child stay seated like this for the whole trip?

## Seating and Safety Restraints

### **Types of booster seats**

There are two types of belt-positioning booster seats:

- Those that are backless.

If your backless booster seat has a removable shield, remove the shield and use the lap/shoulder belt. If a seating position has a low seat back and no head restraint, a backless booster seat may place your child's head (top of ear level) above the top of the seat. In this case, move the backless booster to another seating position with a higher seat back and lap/shoulder belts.



- Those with a high back.

If, with a backless booster seat, you cannot find a seating position that adequately supports your child's head, a high back booster seat would be a better choice.



Both can be used in any vehicle in a seating position equipped with lap/shoulder belts if your child is over 40 lbs.

The shoulder belt should cross the chest, resting snugly on the center of the shoulder. The lap belt should rest low and snug across the hips, never up high across the stomach.

If the booster seat slides on the vehicle seat, placing a rubberized mesh sold as shelf or carpet liner under the booster seat may improve this condition.

### **The importance of shoulder belts**

Using a booster without a shoulder belt increases the risk of a child's head hitting a hard surface in a collision. For this reason, you should never use a booster seat with a lap belt only. It is best to use a booster seat with lap/shoulder belts in the back seat- the safest place for children to ride.

## Seating and Safety Restraints



Follow all instructions provided by the manufacturer of the booster seat.



Never put the shoulder belt under a child's arm or behind the back because it eliminates the protection for the upper part of the body and may increase the risk of injury or death in a collision.



Never use pillows, books, or towels to boost a child. They can slide around and increase the likelihood of injury or death in a collision.

### SAFETY SEATS FOR CHILDREN

#### Child and infant or child safety seats

Use a safety seat that is recommended for the size and weight of the child. Carefully follow all of the manufacturer's instructions with the safety seat you put in your vehicle. If you do not install and use the safety seat properly, the child may be injured in a sudden stop or collision.

When installing a child safety seat:

- Review and follow the information presented in the *Air bag supplemental restraint system (SRS)* section in this chapter.
- Use the correct safety belt buckle for that seating position (the buckle closest to the direction the tongue is coming from).
- Insert the belt tongue into the proper buckle until you hear a snap and feel it latch. Make sure the tongue is securely fastened in the buckle.

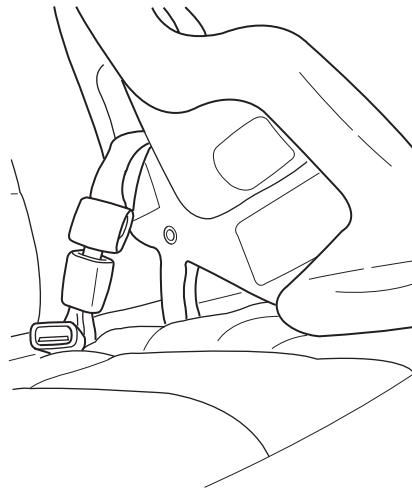

- Place seat back in upright position.

## Seating and Safety Restraints

- Put the safety belt in the automatic locking mode. Refer to *Automatic locking mode* section in this chapter.
- The second row center seat can be moved forward to keep a child in a child restraint close to the front seat occupants. The seat should be moved to the full rearward position when it is occupied by older children or adults.
- LATCH lower anchors are recommended for use by children up to 22 kg (48 pounds) in a child restraint. Top tether anchors can be used for children up to 27 kg (60 pounds) in a child restraint, and to provide upper torso restraint for children up to 36 kg (80 pounds) using an upper torso harness and a belt-positioning booster.

Ford recommends the use of a child safety seat having a top tether strap. Install the child safety seat in a seating position with LATCH and tether anchors. For more information on top tether straps and anchors, refer to *Attaching safety seats with tether straps* in this chapter. For more information of LATCH anchors refer to *Attaching safety seats with LATCH (Lower Anchors and Tethers for Children) attachments* in this chapter.



Carefully follow all of the manufacturer's instructions included with the safety seat you put in your vehicle. If you do not install and use the safety seat properly, the child may be injured in a sudden stop or collision.

### Installing child safety seats with combination lap and shoulder belts



Air bags can kill or injure a child in a child seat. **NEVER** place a rear-facing child seat in front of an active air bag. If you must use a forward-facing child seat in the front seat, move the seat all the way back.



Children 12 and under should be properly restrained in the rear seat whenever possible.

## Seating and Safety Restraints

1. Position the child safety seat in a seat with a combination lap and shoulder belt.

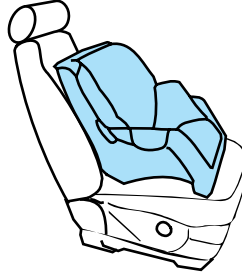

2. Pull down on the shoulder belt and then grasp the shoulder belt and lap belt together.

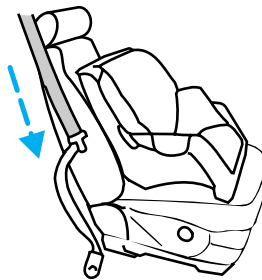

3. While holding the shoulder and lap belt portions together, route the tongue through the child seat according to the child seat manufacturer's instructions. Be sure the belt webbing is not twisted.

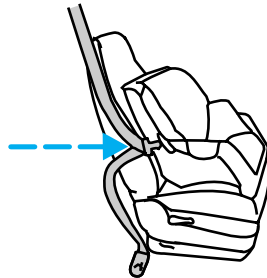

## Seating and Safety Restraints

4. Insert the belt tongue into the proper buckle (the buckle closest to the direction the tongue is coming from) for that seating position until you hear a snap and feel the latch engage. Make sure the tongue is latched securely by pulling on it.

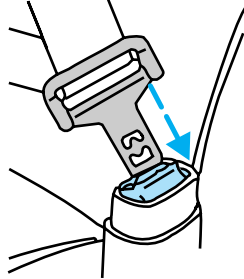

5. To put the retractor in the automatic locking mode, grasp the shoulder portion of the belt and pull downward until all of the belt is pulled out and a click is heard.

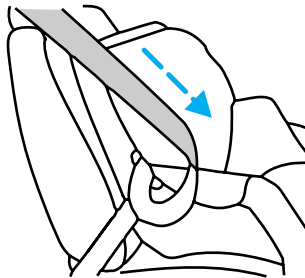

6. Allow the belt to retract. The belt will click as it retracts to indicate it is in the automatic locking mode.

7. Pull the lap belt portion across the child seat toward the buckle and pull up on the shoulder belt while pushing down with your knee on the child seat.

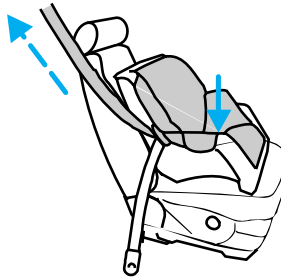



## Seating and Safety Restraints

8. Allow the safety belt to retract to remove any slack in the belt.

9. Before placing the child in the seat, forcibly move the seat forward and back to make sure the seat is securely held in place. To check this, grab the seat at the belt path and attempt to move it side to side and forward. There should be no more than one inch of movement for proper installation.

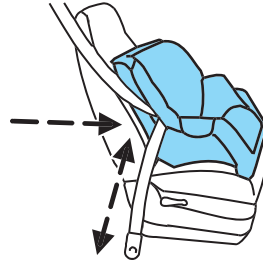

10. Try to pull the belt out of the retractor to make sure the retractor is in the automatic locking mode (you should not be able to pull more belt out). If the retractor is not locked, unbuckle the belt and repeat steps two through nine.

Check to make sure the child seat is properly secured before each use.

### Attaching child safety seats with tether straps

Most new forward-facing child safety seats include a tether strap which goes over the back of the seat and hooks to an anchoring point. Tether straps are available as an accessory for many older safety seats. Contact the manufacturer of your child seat for information about ordering a tether strap.

Some of the rear seats of your vehicle are equipped with built-in tether strap anchors located behind the seats as described below.

In the third row center seating position, the tether anchor is a loop at the bottom of the seatback.

The tether strap anchors in your vehicle are in the following positions (shown from top view):

- Second row bench seat

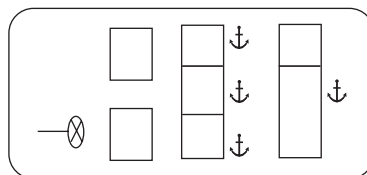

## Seating and Safety Restraints

- Second row bucket seats

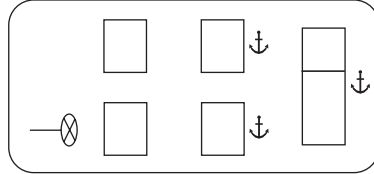

Attach the tether strap only to the appropriate tether anchor as shown. The tether strap may not work properly if attached somewhere other than the correct tether anchor.

### Second row seating positions

1. Position the child safety seat on the seat cushion.
  2. Locate the tether anchor at the bottom back of the seat.
- outboard seating positions

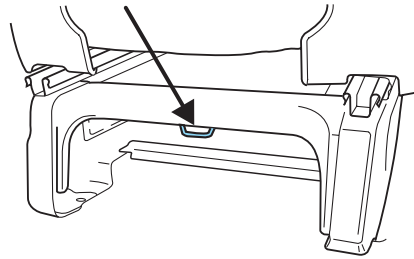

- center seating position (if equipped)

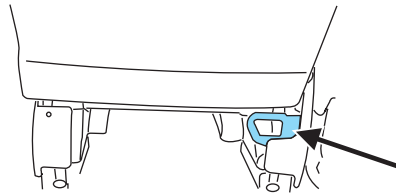

3. Route the child safety seat tether strap under the head restraint (outboard seats) and over the back of the seat.

## Seating and Safety Restraints

4. Grasp the tether strap and position it to the seat frame.

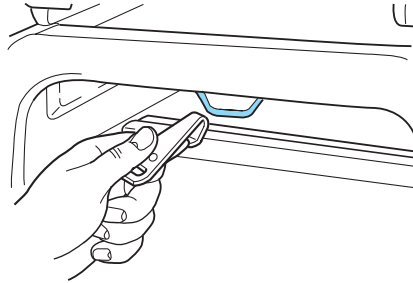

5. Rotate the tether strap, and clip the tether strap to the anchor on the seat frame.

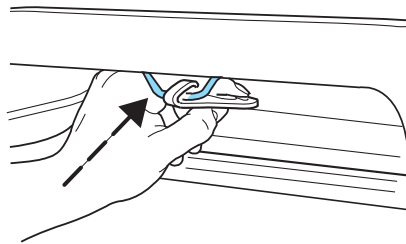

6. Rotate the tether strap clip.

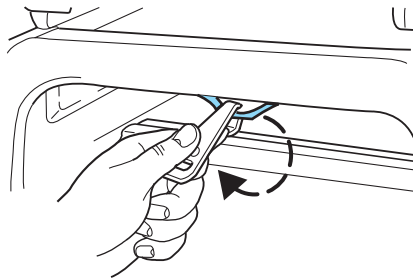

7. Tighten the child safety seat tether strap according to the manufacturer's instructions.

### **Third row seating position**

1. Position the child safety seat on the center of the seat cushion.
2. Route the child safety seat tether strap over the back of the seat.

## Seating and Safety Restraints

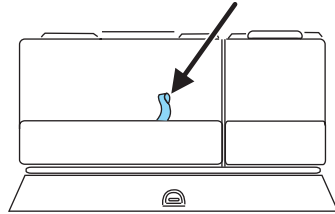

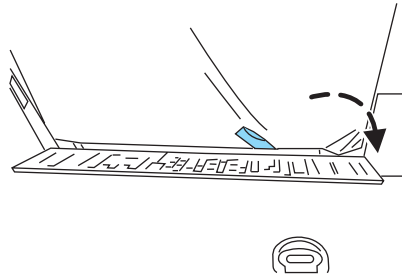

3. Locate the anchor webbing loop for the seating position.

- You may need to pull back the top of the hinged panel along the bottom of the seat back to access the tether anchor.

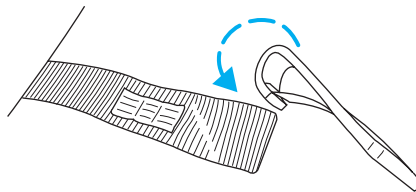

4. Clip the tether strap through the anchor loop as shown.



 If the tether strap is clipped incorrectly, the child safety seat may not be retained properly in the event of a collision.

5. Install the child safety seat tightly using the LATCH anchors or safety belts. Follow the instructions in this chapter.

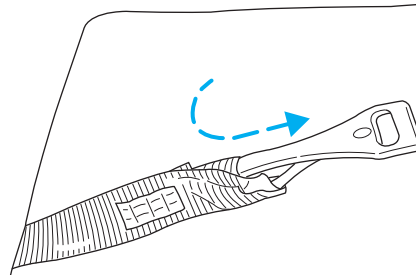

## Seating and Safety Restraints

6. Tighten the child safety seat tether strap according to the manufacturer's instructions.



If the safety seat is not anchored properly, the risk of a child being injured in a collision greatly increases.

### Attaching safety seats with LATCH (Lower Anchors and Tethers for Children) attachments for child seat anchors

Some child safety seats have two rigid or webbing mounted attachments that connect to two anchors at certain seating positions in your vehicle. This type of child seat eliminates the need to use seat belts to attach the child seat. For forward-facing child seats, the tether strap must also be attached to the proper tether anchor. See *Attaching safety seats with tether straps* in this chapter.

Your vehicle has LATCH anchors for child seat installation at the seating positions marked with the child seat symbol:

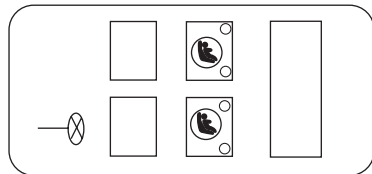
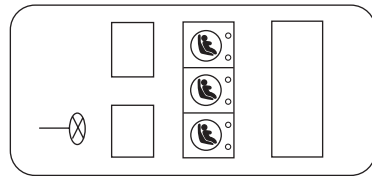

Never attach two LATCH child safety seats to the same anchor. In a crash, one anchor may not be strong enough to hold two child safety seat attachments and may break, causing serious injury or death.

## Seating and Safety Restraints

The lower anchors for child seat installation are located at the rear section of the second row seat between the cushion and seat back. The LATCH anchors are below the locator symbols on the seat back.

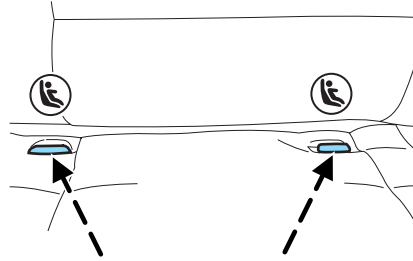

Follow the child seat manufacturer's instructions to properly install a child seat with LATCH attachments.



Attach LATCH lower attachments of the child seat only to the anchors shown.

If you install a child seat with rigid LATCH attachments, do not tighten the tether strap enough to lift the child seat off the vehicle seat cushion when the child is seated in it. Keep the tether strap just snug without lifting the front of the child seat. Keeping the child seat just touching the vehicle seat gives the best protection in a severe crash.

Each time you use the safety seat, check that the seat is properly attached to the lower anchors and tether anchor. Try to move the child seat from side to side. Also try to tug the seat forward. Check to see if the anchors hold the seat in place.



If the safety seat is not anchored properly, the risk of a child being injured in a crash greatly increases.

### STARTING

#### Positions of the ignition

1. OFF/LOCK, locks the steering wheel, automatic transmission gearshift lever and allows key removal.
2. ACCESSORY, allows the electrical accessories such as the radio to operate while the engine is not running.
3. ON, all electrical circuits operational. Warning lights illuminated. Key position when driving.
4. START, cranks the engine. Release the key as soon as the engine starts.

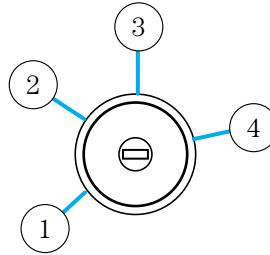

#### Preparing to start your vehicle

Engine starting is controlled by the powertrain control system. This system meets all Canadian Interference-Causing Equipment standard requirements regulating the impulse electrical field strength of radio noise.

When starting a fuel-injected engine, avoid pressing the accelerator before or during starting. Only use the accelerator when you have difficulty starting the engine. For more information on starting the vehicle, refer to *Starting the engine* in this chapter.



Extended idling at high engine speeds can produce very high temperatures in the engine and exhaust system, creating the risk of fire or other damage.



Do not park, idle, or drive your vehicle in dry grass or other dry ground cover. The emission system heats up the engine compartment and exhaust system, which can start a fire.



Do not start your vehicle in a closed garage or in other enclosed areas. Exhaust fumes can be toxic. Always open the garage door before you start the engine. See *Guarding against exhaust fumes* in this chapter for more instructions.

## Driving



If you smell exhaust fumes inside your vehicle, have your dealer inspect your vehicle immediately. Do not drive if you smell exhaust fumes.

### **Important safety precautions**

A computer system controls the engine's idle revolutions per minute (RPM). When the engine starts, the idle RPM runs higher than normal in order to warm the engine. If the engine idle speed does not slow down automatically, have the vehicle checked. Do not allow the vehicle to idle for more than 10 minutes at the higher engine RPM.

Before starting the vehicle:

1. Make sure all vehicle occupants have buckled their safety belts. For more information on safety belts and their proper usage, refer to the *Seating and Safety Restraints* chapter.
2. Make sure the headlamps and vehicle accessories are off.
3. Make sure the gearshift is in P (Park).

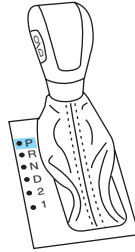

4. Make sure the parking brake is set.

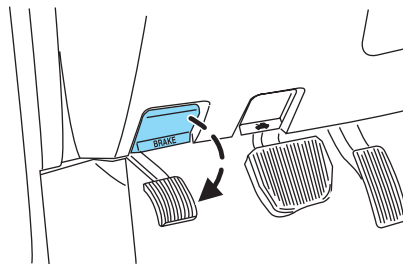



## Driving

5. Turn the key to 3 (ON) without turning the key to 4 (START).

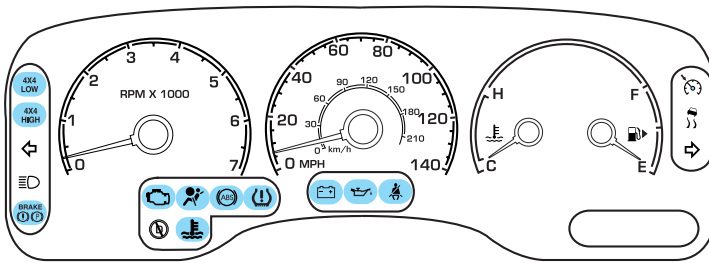
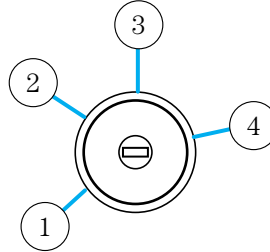

Make sure the corresponding lights illuminate or illuminate briefly. If a light fails to illuminate, have the vehicle serviced.

- If the driver's safety belt is fastened, the  light may not illuminate.

### Starting the engine

**Note:** Whenever you start your vehicle, release the key as soon as the engine starts. Excessive cranking could damage the starter.

1. Turn the key to 4 (START) without pressing the accelerator pedal and release as soon as the engine starts. The key will return to 3 (ON).
2. When the engine starts, release the key.
3. After idling for a few seconds, apply the brake, shift into gear and drive.

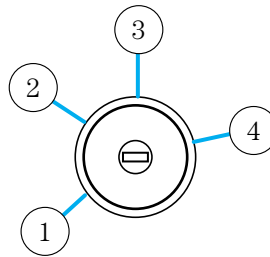

**Note:** If the engine does not start within five seconds on the first try, turn the key to OFF, wait 10 seconds and try again. If the engine still

## Driving

fails to start, press the accelerator to the floor and try again; this will allow the engine to crank with the fuel shut off in case the engine is flooded with fuel.

### Using the engine block heater (if equipped)

If your vehicle is factory-equipped with an engine block heater, a rubber cap/plug assembly will be visibly attached to the grille on the front of the vehicle. For factory equipped, this assembly is loose shipped in-vehicle for dealership installation. If not factory-equipped, the engine block heater can be purchased through dealership accessories. Replacement rubber caps are available through the dealer, 3L1Z-6E088-AA.

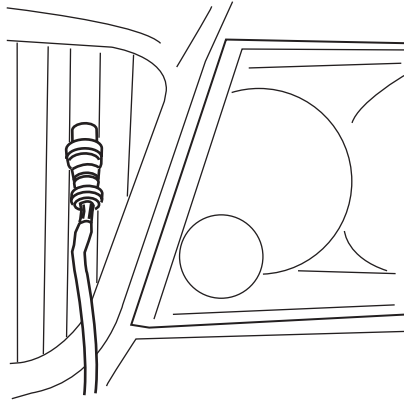

Use of an engine block heater is strongly recommended if you live in a region where temperatures reach  $-10^{\circ}\text{F}$  ( $-23^{\circ}\text{C}$ ) or below. For best results, plug the heater in at least three hours before starting the vehicle (the heater can be plugged in the night before starting the vehicle). To plug the heater in, remove the cap from the plug and insert the plug into a 110 volt grounded outlet. Be sure to re-attach the cap onto the plug when the heater is not in use.

**Note:** Make sure you disconnect the cap from the plug when opening the hood.



To reduce the risk of electrical shock, do not use your heater with ungrounded electrical systems or two-pronged (cheater) adapters.

### Guarding against exhaust fumes

Carbon monoxide is present in exhaust fumes. Take precautions to avoid its dangerous effects.

## Driving



If you smell exhaust fumes inside your vehicle, have your dealer inspect your vehicle immediately. Do not drive if you smell exhaust fumes.

### Important ventilating information

If the engine is idling while the vehicle is stopped for a long period of time, open the windows at least one inch (2.5 cm) or adjust the heating or air conditioning to bring in fresh air.

### BRAKES

Your service brakes are self-adjusting. Refer to the scheduled maintenance guide for scheduled maintenance.

Occasional brake noise is normal and often does not indicate a performance concern with the vehicle's brake system. In normal operation, automotive brake systems may emit occasional or intermittent squeal or groan noises when the brakes are applied. Such noises are usually heard during the first few brake applications in the morning; however, they may be heard at any time while braking and can be aggravated by environmental conditions such as cold, heat, moisture, road dust, salt or mud. If a "metal-to-metal," "continuous grinding" or "continuous squeal" sound is present while braking, the brake linings may be worn-out and should be inspected by a qualified service technician.

Refer to *Brake system warning light* in the *Instrument Cluster* chapter for information on the brake system warning light.



If you are driving down a long or steep hill, shift to a lower gear. Do not apply your brakes continuously, as they may overheat and become less effective.

### Anti-lock brake system (ABS)

On ABS-equipped vehicles, a noise from the hydraulic pump motor and pulsation in the pedal may be observed during ABS braking events. Pedal pulsation coupled with noise while braking under panic conditions or on loose gravel, bumps, wet or snowy roads is normal and indicates proper functioning of the vehicle's anti-lock brake system. The ABS performs a

## Driving

self-check after you start the engine and begin to drive away. A brief mechanical noise may be heard during this test. This is normal. If a malfunction is found, the ABS warning light will come on. If the vehicle has continuous vibration or shudder in the steering wheel while braking, the vehicle should be inspected by a qualified service technician.

The ABS operates by detecting the onset of wheel lockup during brake applications and compensates for this tendency. The wheels are prevented from locking even when the brakes are firmly applied.

### **Using ABS**

- In an emergency or when maximum efficiency from the four-wheel ABS is required, apply continuous force on the brake. The four wheel ABS will be activated immediately, thus allowing you to retain steering control of your vehicle and, providing there is sufficient space, will enable you to avoid obstacles and bring the vehicle to a controlled stop.
- The anti-lock system does not always reduce stopping distance. Always leave enough room between your vehicle and the vehicle in front of you to stop.
- We recommend that you familiarize yourself with this braking technique. However, avoid taking any unnecessary risks.

### **ABS warning lamp**

The ABS warning lamp in the instrument cluster momentarily illuminates when the ignition is turned on. If the light does not illuminate momentarily at start up, remains on or continues to flash, the ABS needs to be serviced.



With the ABS light on, the anti-lock brake system is disabled and normal braking is still effective unless the brake warning light also remains illuminated with parking brake released. (If your brake warning lamp illuminates, have your vehicle serviced immediately.)



### **Brake Assist (if equipped)**

The Brake Assist system provides full braking force during panic braking situations. It detects a rapid application of the brake pedal and maximizes the amount of brake booster assist, helping the driver to

## Driving

achieve maximum braking pressure. Once a panic brake application is detected, the system will remain activated as long as the brake pedal is depressed. The system is deactivated by releasing the brake pedal.

When the system activates, the brake pedal will travel with very little effort; this is normal.

### Parking brake with auto-release (if equipped)

Apply the parking brake whenever the vehicle is parked. To set the parking brake, press the parking brake pedal down until the pedal stops.

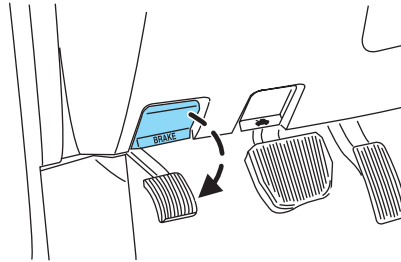

The BRAKE warning lamp in the instrument cluster illuminates and remains illuminated (when the ignition is turned ON) until the parking brake is released.



Always set the parking brake fully and make sure that the gearshift is securely latched in P (Park).

The parking brake is not recommended to stop a moving vehicle. However, if the normal brakes fail, the parking brake can be used to stop your vehicle in an emergency. Since the parking brake applies only the rear brakes, the vehicle's stopping distance will increase greatly and the handling of your vehicle will be adversely affected.

Your vehicle has an automatic parking brake release. To release the parking brake:

1. Turn the ignition to the ON position.
2. Press the brake pedal.
3. Move the gearshift out of the P (Park) position (the parking brake will release automatically when you shift into reverse). The brake pedal must remain pressed while the gearshift is moved.

## Driving

If the parking brake fails to release after completing this procedure, use the manual parking brake release lever.

Pull the release lever to release the brake. Driving with the parking brake on will cause the brakes to wear out quickly and reduce fuel economy.

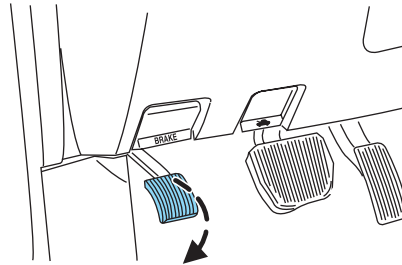

## STEERING

Your vehicle is equipped with power steering. Power steering uses energy from the engine to decrease the driver's effort in steering the vehicle.

To prevent damage to the power steering pump:

- Never hold the steering wheel to the extreme right or the extreme left for more than a few seconds when the engine is running.
- Do not operate the vehicle with the power steering pump fluid level below the MIN mark on the reservoir.

If the power steering system breaks down (or if the engine is turned off), you can steer the vehicle manually, but it takes more effort.

If the steering wanders or pulls, check for:

- Underinflated tire(s) on any wheel(s)
- Uneven vehicle loading
- High crown in center of road
- High crosswinds
- Wheels out of alignment
- Loose or worn suspension components

### Speed sensitive steering

Your vehicle is equipped with speed sensitive, variable assist power steering. At low speeds, steering assist will adjust to reduce efforts and improve low speed maneuverability and at high speeds, the assist will adjust to improve steering feel.

If the amount of effort required to steer your vehicle changes while driving at a constant vehicle speed, have the power steering system checked by your dealer or a qualified service technician.

### AIR SUSPENSION SYSTEM

The air suspension system is designed to improve ride comfort, vehicle handling and general vehicle performance by adjusting the vehicle's ride height according to vehicle speed, weight added to or removed from the vehicle and four-wheel drive (if equipped) operation. Normal vehicle operation does not require any action by the driver.

When you enter the vehicle and the ignition is off, the air suspension will have automatically lowered the vehicle to its lowest height to provide easier entry. When a door or the liftgate is opened, the system memorizes and maintains that height until either all doors are closed or the vehicle's speed exceeds 15 mph (24 km/h). The air suspension system will then raise the vehicle's height to its normal position when the ignition is turned on, all doors are closed and the transmission is shifted from P (Park).

When the vehicle is in motion, the air suspension will adjust the vehicle ride height to normal operating position to maximize your ride comfort. If your vehicle is equipped with four-wheel drive and you shift into 4WD LOW, the air suspension will not move to its lowest position; instead, the ride height is raised above the normal ride height position (at speeds below 25 mph [40 km/h]) to improve ground clearance.

If a load is added to, or removed from the vehicle, the load leveling feature of the air suspension system will adjust the suspension to keep the vehicle at a constant level.

When exiting the vehicle, the air suspension will automatically lower the vehicle to its lowest height to provide easier exit. You may hear a buzz or click from the air suspension system when the ignition is turned off. The air suspension system will stay active for 40 minutes after the ignition is turned off to accommodate any load changes. (The air compressor may run when the vehicle is off; this is normal.)

The air suspension shut-off switch is located behind an access panel on the left rear quarter trim panel, near the liftgate. To remove the panel, turn the control counterclockwise.



On vehicles equipped with air suspension, turn the air suspension and the ignition switch off prior to jacking, hoisting or towing your vehicle.

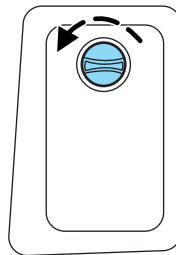

## Driving

Press the bottom portion of the switch to turn off the air suspension.

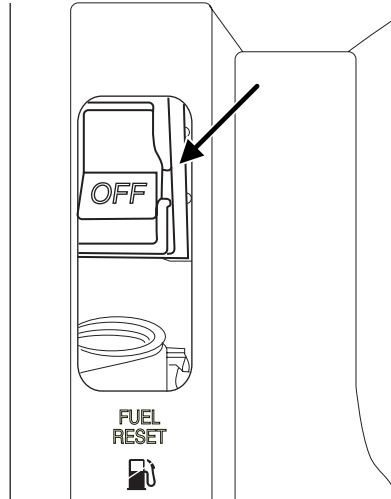

### LIMITED-SLIP AXLE (IF EQUIPPED)

This axle provides added traction on slippery surfaces, particularly when one wheel is on a poor traction surface. Under normal conditions, the limited slip axle functions like a standard rear axle.

Extended use of other than the manufacturer's specified size tires on a limited slip rear axle could result in a permanent reduction in effectiveness. This loss of effectiveness does not affect normal driving and should not be noticeable to the driver.

### PREPARING TO DRIVE YOUR VEHICLE



Utility vehicles have a significantly higher rollover rate than other types of vehicles.



In a rollover crash, an unbelted person is significantly more likely to die than a person wearing a seat belt.

Your vehicle has special design and equipment features to make it capable of performing in a wide variety of circumstances. These special design features, such as larger tires and increased ground clearance, give the vehicle a higher center of gravity than a passenger car.

240



## Driving



Vehicles with a higher center of gravity such as utility and four-wheel drive vehicles handle differently than vehicles with a lower center of gravity. Utility and four-wheel drive vehicles are **not** designed for cornering at speeds as high as passenger cars any more than low-slung sports cars are designed to perform satisfactorily under off-road conditions. Avoid sharp turns, excessive speed and abrupt maneuvers in these vehicles. Failure to drive cautiously could result in an increased risk of loss of vehicle control, vehicle rollover, personal injury and death.



Loaded vehicles, with a higher center of gravity, may handle differently than unloaded vehicles. Extra precautions, such as slower speeds and increased stopping distance, should be taken when driving a heavily loaded vehicle.

Your vehicle has the capability to haul more cargo and people than most passenger cars. Depending upon the type and placement of the load, hauling people and cargo may raise the center of gravity of the vehicle.

Use extra caution while becoming familiar with your vehicle. Know the capabilities and limitations of both you as a driver and your vehicle.

### **ROLL STABILITY CONTROL STABILITY ENHANCEMENT SYSTEM (IF EQUIPPED)**

The Roll Stability Control system provides a stability enhancement feature as well as a traction enhancement feature. It helps your vehicle maintain traction, when driving on slippery and/or hilly road surfaces, by detecting and controlling wheel spin. Excessive wheel spin is controlled by momentarily reducing engine power and rapidly applying the anti-lock brakes. The system is a driver aid which makes your vehicle easier to handle primarily on snow and ice-covered roads.

If your vehicle should become stuck in deep snow or mud, try switching the Roll Stability Control system off by pressing the Roll Stability Control button. This will allow your tires to “dig” for traction.

If the Roll Stability Control system is activated and deactivated excessively in a short period of time, the brake portion of the system will shut down to allow the brakes to cool down. A limited Roll Stability Control function using only engine power reduction will still help control the wheels from over-spinning. When the brakes have cooled down, the system will again function normally. Anti-lock braking is not affected by this condition and will function normally during the cool-down period.

## Driving

Roll Stability Control enhances your vehicle's stability during maneuvers that require all available tire traction, like in wet/snowy/icy road conditions and/or when performing emergency maneuvers. In an emergency lane-change, the driver will experience better overall vehicle traction, and have better control of the vehicle.

The Roll Stability Control system helps the driver maintain steering control if the vehicle begins to slide excessively left or right or spin out. Roll Stability Control will attempt to correct the sliding motion by applying brake force at individual tires and, if necessary, by reducing engine power.

Driving conditions which may activate Roll Stability Control include:

- Taking a turn too fast
- Maneuvering quickly to avoid an accident, pedestrian or obstacle
- Hitting a patch of ice
- Changing lanes on a snow-rutted road
- Entering a snow-free road from a snow-covered side street, or vice versa
- Entering a paved road from a gravel road, or vice versa
- Hitting a curb while turning
- Driving on slick surfaces
- Cornering while towing a heavily loaded trailer (refer to *Trailer Towing* in this chapter)

The Roll Stability Control (RSC) system works to further enhance the vehicle's overall stability during aggressive maneuvers. The system helps maintain roll stability of the vehicle during aggressive maneuvers by applying brake force to one or more wheels.

Driving conditions that may activate Roll Stability Control include:

- Emergency lane-change
- Taking a turn too fast
- Quick maneuvering to avoid an accident, pedestrian or obstacle
- Hitting a curb while turning

The Roll Stability Control system automatically turns on when the engine is started. However, the system does not function when the vehicle is traveling in R (Reverse) or, if equipped with four-wheel drive, in 4L (4X4 LOW). In R (Reverse) or in 4L (4X4 LOW), ABS and the traction enhancement feature will continue to function.

The Roll Stability Control button allows the driver to control the availability of the Roll Stability Control system. The Roll Stability Control system status is indicated by a warning indicator light with a “sliding car” icon in the instrument cluster that will flash when the system is activated and an indicator light in the control button that will illuminate when the system is turned off. In vehicles with a message center, the message “Roll Stability Control OFF” will be displayed.

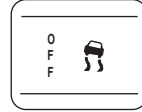

If a failure is detected in the Roll Stability Control system, the warning indicator light in the instrument cluster will stay on. If the warning indicator light in the instrument cluster remains on while the engine is running, have the system serviced immediately.

Pressing the button once will disable the Roll Stability Control stability enhancement and the engine power reduction portion of the traction enhancement feature; the brake portion of the traction enhancement feature will still function normally. Pressing and holding the button for more than five seconds will disable the Roll Stability Control stability enhancement **and** traction enhancement feature. If the vehicle is stuck in snow or mud or when driving in deep sand, switching off the Roll Stability Control system may be beneficial so the wheels are allowed to spin. If your vehicle seems to lose engine power while driving in deep sand or very deep snow, switching off the Roll Stability Control stability enhancement feature will restore full engine power and will enhance momentum through the obstacle.

Some drivers may notice a slight movement of the brake pedal when the Roll Stability Control performs a system self-check. During Roll Stability Control operation you may experience the following:

- A rumble or grinding noise
- A slight deceleration of the vehicle
- The Roll Stability Control indicator light will flash
- If your foot is on the brake pedal, you will feel a vibration in the pedal.
- If the driving condition is severe and your foot is not on the brake, the brake pedal will move to apply higher brake forces. You may also hear a whoosh of air from under the instrument panel during this severe condition.

All these conditions are normal during Roll Stability Control operation.

## Driving

**Do not alter or modify your vehicle's suspension or steering; the resulting changes to the vehicle's handling can adversely affect the Roll Stability Control system. Also, do not install a stereo loudspeaker near the front center console or under either front seat. The speaker vibrations can adversely affect the Roll Stability Control sensors located in this area.**

**Note:** Pressing the Roll Stability Control button will disable the Roll Stability Control.



Aggressive driving in any road conditions can cause you to lose control of your vehicle increasing the risk of severe personal injury or property damage. The occurrence of an Roll Stability Control event is an indication that at least some of the tires have exceeded their ability to grip the road; this may lead to an increased risk of loss of vehicle control, vehicle rollover, personal injury and death. If you experience a severe road event, SLOW DOWN.

## AUTOMATIC TRANSMISSION OPERATION

### Brake-shift interlock

This vehicle is equipped with a brake-shift interlock feature that prevents the gearshift lever from being moved from P (Park) when the ignition is in the ON position unless brake pedal is depressed.

If you cannot move the gearshift lever out of P (Park) with ignition in the ON position and the brake pedal depressed, it is possible that a fuse has blown or the vehicle's brakelamps are not operating properly. Refer to *Fuses and relays* in the *Roadside Emergencies* chapter.

If the fuse is not blown, perform the following procedure:

1. Apply the parking brake, turn the ignition to LOCK, then remove the key.
2. Using a smooth, non-metallic tool (such as a plastic screwdriver, or equivalent) between the shift lever boot and the plastic bezel, pry the bezel assembly away from its locking tabs. **Use caution not to damage the plastic bezel assembly or shift lever boot when prying the bezel assembly from the locking tabs.**

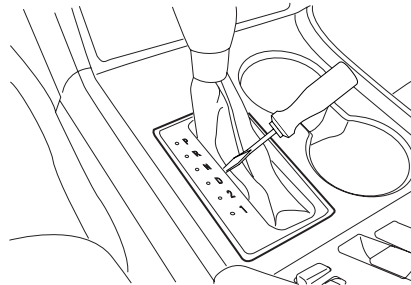

## Driving

3. Pull the bezel assembly up far enough to expose the inside of the gearshift lever compartment.

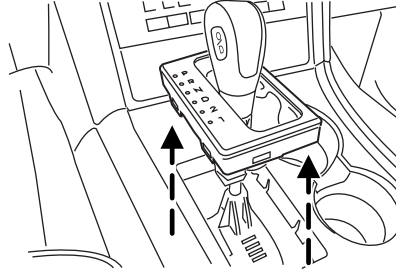

4. Press and hold the white button located along side the shifter housing assembly (as shown in the illustration). Press the gearshift lever release on the shifter knob and move the gearshift lever back to N (Neutral) (two places rearward from P [Park]).

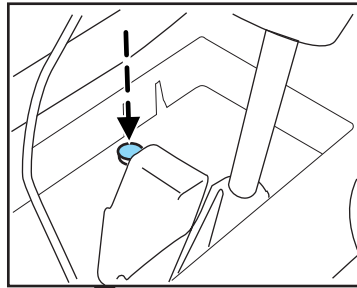

5. Start the vehicle and release the parking brake.

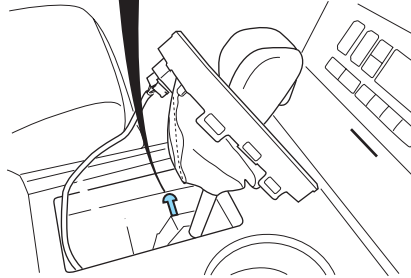

Do not drive your vehicle until you verify that the brakelamps are working.



Always set the parking brake fully and make sure the gearshift is latched in P (Park). Turn the ignition to the LOCK position and remove the key whenever you leave your vehicle.

## Driving



If the parking brake is fully released, but the brake warning lamp remains illuminated, the brakes may not be working properly. See your dealer or a qualified service technician.

### Driving with a 4-speed automatic transmission

Your vehicle's automatic transmission is equipped with a special shift strategy that insures maximum heater performance during cold weather operation.

When ambient temperature is 23°F (-5°C) or below and the engine coolant temperature is below 100°F (38°C), light throttle upshifts may be slightly delayed. Once the engine coolant temperature reaches 160°F (71°C) the normal shift strategy will resume. This is normal operation and will not affect the function or the durability of the transmission.

**If the normal shift strategy does not resume once the engine coolant temperature reaches the normal operating temperature, or if the downshifts and other throttle conditions do not function normally, see your dealer or a qualified service technician as soon as possible.**

### Understanding gearshift positions

To put your vehicle in gear, start the engine, depress the brake pedal, then move gearshift lever out of P (Park).



Hold the brake pedal down while you move the gearshift lever from P (Park) to another position. If you do not hold the brake pedal down, your vehicle may move unexpectedly and injure someone.

### P (Park)

Always come to a complete stop before shifting into P (Park). Make sure the gearshift lever is securely latched in P (Park). This position locks the transmission and prevents the rear wheels from turning.

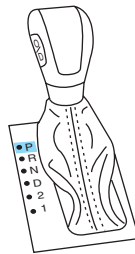

## Driving

 Always set the parking brake fully and make sure the gearshift is latched in P (Park). Turn the ignition to the LOCK position and remove the key whenever you leave your vehicle.

### **R (Reverse)**

With the gearshift lever in R (Reverse), the vehicle will move backward. Always come to a complete stop before shifting into and out of R (Reverse).

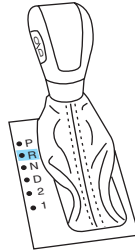

### **N (Neutral)**

With the gearshift lever in N (Neutral), the vehicle can be started and is free to roll. Hold the brake pedal down while in this gear.

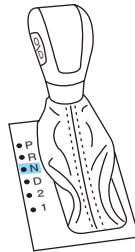

### **D (Drive) with Overdrive**

The normal driving position for the best fuel economy. Transmission operates in gears one through four.

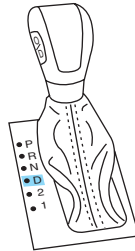

## Driving

### **D (Drive) without Overdrive**

D (Drive) with Overdrive can be deactivated by pressing the transmission control switch (TCS) on the end of the gearshift lever.

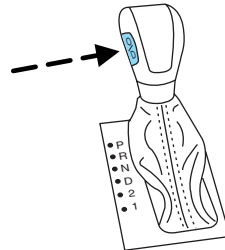

The transmission control indicator light (TCIL) will illuminate in the instrument cluster.



Transmission operates in gears one through three. D (Drive) without Overdrive provides more engine braking than D (Drive) with Overdrive and is useful when:

- driving with a heavy load.
- towing a trailer up or down steep hills.
- additional engine downhill braking is desired. If towing a trailer, refer to *Driving while you tow* in the *Trailer towing* section.

To return to D (Drive) with Overdrive mode, press the transmission control switch (TCS). The TCIL will no longer be illuminated.

Each time the vehicle is started, the transmission will automatically return to normal overdrive mode.

Every time the vehicle is shut off and restarted, you must press the transmission control switch to cancel overdrive operation if driving in overdrive is not desired.



### **2 (Second)**

Use 2 (Second) to start-up on slippery roads or to provide additional engine braking on downgrades.

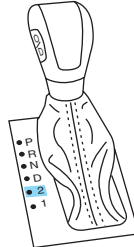

### **1 (First)**

Use 1 (Low) to provide maximum engine braking on steep downgrades. Upshifts can be made by shifting to 2 (Second) or to D (Drive). Selecting 1 (Low) at higher speeds causes the transmission to shift to a lower gear, and will shift to 1 (Low) after vehicle decelerates to the proper speed.

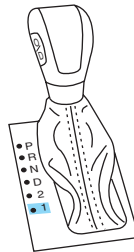

### **Forced Downshifts**

To gain acceleration in D (Drive) with Overdrive or D (Drive) without Overdrive (O/D OFF) when passing another vehicle, push the accelerator to the floor. The transmission will downshift to the appropriate gear: third, second or first gear.

### **Shift strategy**

This vehicle is equipped with an adaptive Transmission Shift Strategy. Adaptive Shift Strategy offers the optimal transmission operation and shift quality. When the vehicle's battery has been disconnected for any type of service or repair, the transmission will need to relearn the normal shift strategy parameters, much like having to reset your radio stations when your vehicle battery has been disconnected. The Adaptive Transmission Strategy allows the transmission to relearn these operating parameters. This learning process could take several transmission upshifts and downshifts; during this learning process, slightly firmer shifts may occur. After this learning process, normal shift feel and shift scheduling will resume.

## Driving

### If your vehicle gets stuck in mud or snow

If your vehicle gets stuck in mud or snow, it may be rocked out by shifting from forward and reverse gears, stopping between shifts in a steady pattern. Press lightly on the accelerator in each gear.

**Do not rock the vehicle if the engine is not at normal operating temperature or damage to the transmission may occur.**

**Do not rock the vehicle for more than a minute or damage to the transmission and tires may occur, or the engine may overheat.**

If your vehicle is equipped with AdvanceTrac<sup>®</sup>, it may be beneficial to turn the system off so the wheels are allowed to spin.

### EXTENDED REAR PARK ASSIST

The extended rear park assist system sounds a tone to warn the driver of obstacles near the rear bumper when R (Reverse) gear is selected.



To help avoid personal injury, please read and understand the limitations of the extended rear park assist system as contained in this section. The park assist is only an aid for some (generally large and fixed) objects when moving in reverse on a flat surface at “parking speeds”. Inclement weather may also affect the function of the system; this may include reduced performance or a false activation.



To help avoid personal injury, always use caution when in R (Reverse) and when using the extended rear park assist.



This system is not designed to prevent contact with small or moving objects. The system is designed to provide a warning to assist the driver in detecting objects to avoid damaging the vehicle. The system may not detect smaller objects, particularly those close to the ground.



Certain add-on devices such as large trailer hitches, bike or surfboard racks and any device that may block the normal detection zone of the RSS system may create false beeps.

The system will assist the driver in detecting certain objects while the vehicle slowly moves in reverse at speeds less than 6 mph (10 km/h). The system is not effective at speeds greater than 6 mph (10 km/h) and may not detect certain angular or moving objects.

250

## Driving

The system detects obstacles up to a maximum range of 20 feet (six meters at speeds above 2 mph [3 km/h]) or 10 feet (3 meters at speeds below 2 mph [3 km/h]) behind the rear bumper with a decreased coverage area at the outer corners of the bumper, (refer to the figures for approximate zone coverage areas). As you move closer to the obstacle, the rate of the tone increases. When the distance to the obstacle is less than 18 inches (45.0 cm), the tone will sound continuously. If the system detects an object that is approaching the vehicle at such a rate that rapid braking is required, a very high rate tone will sound. If this tone is heard while reversing, the driver is advised to slow down immediately until the tone either changes to a slower rate or stops.

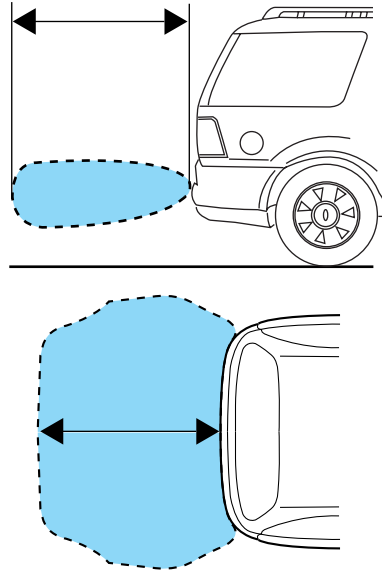

While receiving a warning the radio volume will be reduced to a predetermined level. After the warning goes away, the radio will return to the previous volume. The radio volume may be overridden using the radio volume control.

The extended rear park assist is automatically enabled when the gear selector is placed in R (Reverse) and the ignition is ON. A park assist control in the message center allows the driver to disable the extended rear park aid only when the ignition is ON, and the gear selector is in R (Reverse).

**Always keep the sensors (located on the rear bumper/fascia) free from snow, ice and large accumulations of dirt (do not clean the sensors with sharp objects). These elements may cause the system to operate inaccurately.**

**If the vehicle sustains damage to the rear bumper/fascia, leaving it misaligned or bent, the sensing zone may be altered causing inaccurate measurement of obstacles or false alarms.**

## Driving

### CONTROL TRAC FOUR-WHEEL DRIVE (4X4) OPERATION (IF EQUIPPED)



For important information regarding safe operation of this type of vehicle, see **Preparing to drive your vehicle** in this chapter.

**If equipped with the Control Trac 4x4 System, and 4L (4x4 LOW) is selected while the vehicle is moving, the system will not engage. This is normal and should be no reason for concern. Before 4L (4x4 LOW) can be engaged, the vehicle must be brought to a complete stop, the brake pedal depressed and the transmission placed in N (Neutral).**

The vehicle should not be operated in 4H (4x4 HIGH) or 4L (4x4 LOW) on dry pavement. Doing so could result in difficult disengagement of the transfer case, increased tire wear, decreased fuel economy and may damage driveline components.

Your 4x4 features the heavy-duty Control Trac system which includes a computer-operated transfer case. This unique system is interactive with the road, continually monitoring and adjusting torque delivery to the front and rear wheels to optimize vehicle control.

#### System indicator lights

The Control Trac system indicator lights illuminate only under the following conditions. If these lights illuminate when driving in 2H or A4WD, contact your Ford dealer as soon as possible.

- **4X4 HIGH** - momentarily illuminates when the vehicle is started. Illuminates when 4H is selected. **4x4 HIGH**
- **4X4 LOW** - momentarily illuminates when the vehicle is started. Illuminates when 4L is selected. **4x4 LOW**

### Positions of the Control Trac system

The Control Trac system functions in four modes:

- **2H (2WD HIGH)** delivers power to the rear wheels only. This is appropriate for normal on-road driving on dry pavement.
- **A4WD (4X4 AUTO)** provides electronic control four-wheel drive with power delivered to all four wheels, as required, for increased traction. This is appropriate for all on-road driving conditions, such as dry road surfaces, wet pavement, snow or gravel.
- **4H (4X4 HIGH)** provides mechanically locked four-wheel drive power to front and rear wheels. The “4X4” light will illuminate in the instrument cluster when this position is selected. This position is not recommended for use on dry pavement. This position is only intended for severe winter or off-road conditions, such as deep snow, ice or shallow sand.
- **4L (4X4 LOW)** provides mechanically locked four-wheel drive when extra power at reduced speeds is required. The “4X4 LOW” light will illuminate in the instrument cluster when this position is selected. This position is not recommended for use on dry pavement. Use this position for off-road low-speed operation or when extra power is required, such as climbing steep grades, going through deep sand or pulling a boat out of the water.

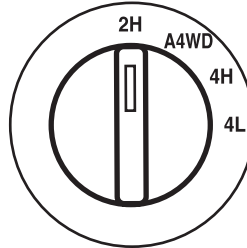

**Note:** If your vehicle is equipped with AdvanceTrac™, the AdvanceTrac™ system will automatically turn off the stability enhancement feature when you shift the Control Trac A4WD system into 4L (4X4 LOW). The brake traction enhancement feature will still be enabled.

The AdvanceTrac™ stability enhancement system can be turned off manually by pressing the AdvanceTrac™ button (refer to *AdvanceTrac™ Stability Enhancement System* in this chapter) while operating in 2H, A4WD or 4H while driving in deep sand, very deep snow or more strenuous off-road maneuvers. This will disable the engine management feature, allowing the vehicle to maintain full power and enhanced momentum through the obstacle.

## Driving

 Utility and four-wheel drive vehicles are **not** designed for cornering at speeds as high as passenger cars any more than low-slung sports cars are designed to perform satisfactorily under off-road conditions. Avoid sharp turns or abrupt maneuvers in these vehicles.

**Note:** The Control Trac selector knob should not be changed while the rear wheels are slipping.

### Using the Control Trac system

#### **Shifting from 2H to A4WD or 4H**

Move the control to the A4WD or 4H position at any forward speed up to 55 mph (88 km/h). The “4X4” light in the instrument cluster will illuminate if 4H is selected.

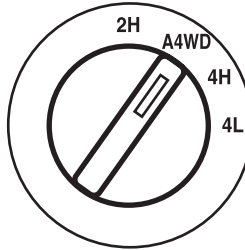

#### **Shifting from A4WD to 4H**

Move the control from A4WD to 4H at a stop or while driving at any speed.

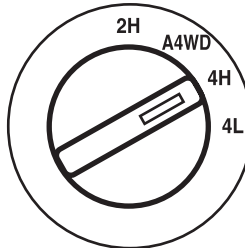

### Shifting from 2H, A4WD or 4H to 4L

1. Bring the vehicle to a stop and keep the brake pedal depressed.
2. Place the gearshift in N (Neutral).
3. Move the control to the 4L position.

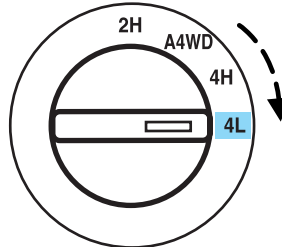

**Note:** Some noise may be heard as the system shifts or engages.

### Shifting from 4L to 4H, A4WD or 2H

1. Bring the vehicle to a stop and keep the brake pedal depressed.
2. Place the gearshift in N (Neutral).
3. Move the control to the 4H, A4WD or 2H position.

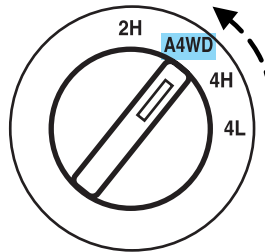

**Note:** Some noise may be heard as the system shifts or engages.

### Driving off-road with truck and utility vehicles

Four-wheel drive vehicles are specially equipped for driving on sand, snow, mud and rough terrain and have operating characteristics that are somewhat different from conventional vehicles, both on and off the road. The AdvanceTrac™ stability enhancement system can be turned off manually by pressing the AdvanceTrac™ button (refer to *AdvanceTrac™ Stability Enhancement System* in this chapter) while operating in 2H, A4WD or 4H while driving in deep sand, very deep snow or more strenuous off-road maneuvers. This will disable the engine management feature, allowing the vehicle to maintain full power and enhanced momentum through the obstacle.

#### How your vehicle differs from other vehicles

Truck and utility vehicles can differ from some other vehicles. Your vehicle may be higher to allow it to travel over rough terrain without getting hung up or damaging underbody components.

## Driving

The differences that make your vehicle so versatile also make it handle differently than an ordinary passenger car.

Maintain steering wheel control at all times, especially in rough terrain. Since sudden changes in terrain can result in abrupt steering wheel motion, make sure you grip the steering wheel from the outside. Do not grip the spokes.

Drive cautiously to avoid vehicle damage from concealed objects such as rocks and stumps.

You should either know the terrain or examine maps of the area before driving. Map out your route before driving in the area. To maintain steering and braking control of your vehicle, you must have all four wheels on the ground and they must be rolling, not sliding or spinning.

### ***Basic operating principles***

- Do not use 4H (4x4 HIGH) or 4L (4x4 LOW) on dry, hard surfaced roads. This may damage the drivelines and axles.
- Drive slower in strong crosswinds which can affect the normal steering characteristics of your vehicle.
- Be extremely careful when driving on pavement made slippery by loose sand, water, gravel, snow or ice.

### ***If your vehicle goes off the edge of the pavement***

- If your vehicle goes off the edge of the pavement, slow down, but avoid severe brake application. Ease the vehicle back onto the pavement only after reducing your speed. Do not turn the steering wheel too sharply while returning to the road surface.
- It may be safer to stay on the apron or shoulder of the road and slow down gradually before returning to the pavement. You may lose control if you do not slow down or if you turn the steering wheel too sharply or abruptly.
- It often may be less risky to strike small objects, such as highway reflectors, with minor damage to your vehicle rather than attempt a sudden return to the pavement which could cause the vehicle to slide sideways out of control or roll over. Remember, your safety and the safety of others should be your primary concern.



## Driving



Vehicles with a higher center of gravity such as utility and four-wheel drive vehicles handle differently than vehicles with a lower center of gravity. Utility and four-wheel drive vehicles are **not** designed for cornering at speeds as high as passenger cars any more than low-slung sports cars are designed to perform satisfactorily under off-road conditions. Avoid sharp turns, excessive speed and abrupt maneuvers in these vehicles. Failure to drive cautiously could result in an increased risk of loss of vehicle control, vehicle rollover, personal injury and death.

### ***If your vehicle gets stuck***

If your vehicle gets stuck in mud or snow it may be rocked out by shifting between forward and reverse gears, stopping between shifts, in a steady pattern. Press lightly on the accelerator in each gear.

**Do not rock the vehicle if the engine is not at normal operating temperature or damage to the transmission may occur.**

**Do not rock the vehicle for more than a few minutes or damage to the transmission and tires may occur or the engine may overheat.**



Always set the parking brake fully and make sure the gearshift is latched in P (Park). Turn the ignition to the LOCK position and remove the key whenever you leave your vehicle.



If the parking brake is fully released, but the brake warning lamp remains illuminated, the brakes may not be working properly. See your dealer or a qualified service technician.



Do not spin the wheels at over 35 mph (56 km/h). The tires may fail and injure a passenger or bystander.

### ***Emergency maneuvers***

- In an unavoidable emergency situation where a sudden sharp turn must be made, remember to avoid “over-driving” your vehicle, i.e., turn the steering wheel only as rapidly and as far as required to avoid the emergency. Excessive steering will result in less vehicle control, not more. Additionally, smooth variations of the accelerator and/or brake pedal pressure should be utilized if changes in vehicle speed are

## Driving

called for. Avoid abrupt steering, acceleration or braking which could result in an increased risk of loss of vehicle control, vehicle rollover and/or personal injury. Use all available road surface to return the vehicle to a safe direction of travel.

- In the event of an emergency stop, avoid skidding the tires and do not attempt any sharp steering wheel movements.



Vehicles with a higher center of gravity such as utility and four-wheel drive vehicles handle differently than vehicles with a lower center of gravity. Utility and four-wheel drive vehicles are **not** designed for cornering at speeds as high as passenger cars any more than low-slung sports cars are designed to perform satisfactorily under off-road conditions. Avoid sharp turns, excessive speed and abrupt maneuvers in these vehicles. Failure to drive cautiously could result in an increased risk of loss of vehicle control, vehicle rollover, personal injury and death.

- If the vehicle goes from one type of surface to another (i.e., from concrete to gravel) there will be a change in the way the vehicle responds to a maneuver (steering, acceleration or braking). Again, avoid these abrupt inputs.

### **Control Trac four-wheel drive system (if equipped)**

When a four-wheel drive mode is selected, the Control Trac system uses all four wheels to power the vehicle. This increases traction, enabling you to drive over terrain and road conditions that a conventional two-wheel drive vehicle cannot.

Power is supplied to all four wheels through a transfer case. On four-wheel drive vehicles, the transfer case allows you to select four-wheel drive when necessary. Information on transfer case operation and shifting procedures can be found in this chapter.

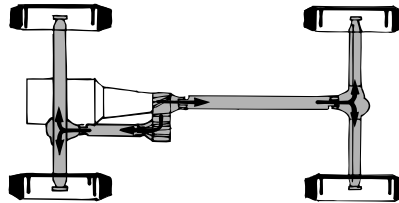

Information on transfer case maintenance can be found in the *Maintenance and Specifications* chapter. You should become thoroughly familiar with this information before you operate your vehicle.

### **Normal characteristics**

On some four-wheel drive models, the initial shift from two-wheel drive to four-wheel drive while the vehicle is moving can cause some

## Driving

momentary clunk and ratcheting sounds. This is the front drivetrain coming up to speed and engaging the front wheels, and is not cause for concern.

### **Sand**

When driving over sand, try to keep all four wheels on the most solid area of the trail. Avoid reducing the tire pressures but shift to a lower gear and drive steadily through the terrain. Apply the accelerator slowly and avoid spinning the wheels.

If you must reduce the tire pressure for whatever reason in sand, make sure you re-inflate the tires as soon as possible.

**Note:** If your vehicle is equipped with the tire pressure monitoring system, the system indicator light may illuminate depending on how much air is released from your tires and/or how long you drive the vehicle under these conditions.

Avoid excessive speed because vehicle momentum can work against you and cause the vehicle to become stuck to the point that assistance may be required from another vehicle. Remember, you may be able to back out the way you came if you proceed with caution.

If your vehicle is equipped with AdvanceTrac<sup>™</sup>, press the AdvanceTrac<sup>™</sup> button (refer to *AdvanceTrac<sup>™</sup> Stability Enhancement System* in this chapter) while driving in deep sand if you experience excessive engine power reduction.

### **Mud and water**

If you must drive through high water, drive slowly. Traction or brake capability may be limited.

When driving through water, determine the depth; avoid water higher than the bottom of the hubs (if possible) and proceed slowly. If the ignition system gets wet, the vehicle may stall.

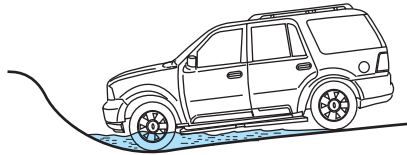

Once through water, always try the brakes. Wet brakes do not stop the vehicle as effectively as dry brakes. Drying can be improved by moving your vehicle slowly while applying light pressure on the brake pedal.

Be cautious of sudden changes in vehicle speed or direction when you are driving in mud. Even four-wheel drive vehicles can lose traction in

## Driving

slick mud. As when you are driving over sand, apply the accelerator slowly and avoid spinning your wheels. If the vehicle does slide, steer in the direction of the slide until you regain control of the vehicle.

If the transmission, transfer case or front axle are submerged in water, their fluids should be checked and changed, if necessary.

### **Driving through deep water may damage the transmission.**

If the front or rear axle is submerged in water, the axle lubricant should be replaced.

After driving through mud, clean off residue stuck to rotating driveshafts and tires. Excess mud stuck on tires and rotating driveshafts causes an imbalance that could damage drive components.

“Tread Lightly” is an educational program designed to increase public awareness of land-use regulations and responsibilities in our nations wilderness areas. Ford Motor



Company joins the U.S. Forest Service and the Bureau of Land Management in encouraging you to help preserve our national forest and other public and private lands by “treading lightly.”

### **Driving on hilly or sloping terrain**

Although natural obstacles may make it necessary to travel diagonally up or down a hill or steep incline, you should always try to drive straight up or straight down. **Avoid driving crosswise or turning on steep slopes or hills.** A danger lies in losing traction, slipping sideways and possibly rolling over. Whenever driving on a hill, determine beforehand the route you will use. Do not drive over the crest of a hill without seeing what conditions are on the other side. Do not drive in reverse over a hill without the aid of an observer.

When climbing a steep slope or hill, start in a lower gear rather than downshifting to a lower gear from a higher gear once the ascent has started. This reduces strain on the engine and the possibility of stalling.

If you do stall out, do not try to turn around because you might roll over. It is better to back down to a safe location.

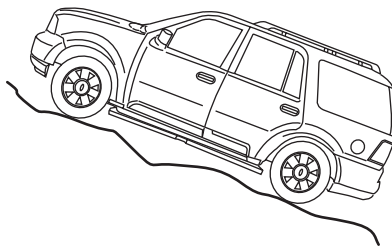

Apply just enough power to the wheels to climb the hill. Too much power will cause the tires to slip, spin or lose traction, resulting in loss of vehicle control.

Descend a hill in the same gear you would use to climb up the hill to avoid excessive brake application and brake overheating. Do not descend in neutral; instead, disengage overdrive or manually shift to a lower gear. When descending a steep hill, avoid sudden hard braking as you could lose control. When you brake hard, the front wheels can't turn and if they aren't turning, you won't be able to steer. The front wheels have to be turning in order to steer the vehicle. Rapid pumping of the brake pedal will help you slow the vehicle and still maintain steering control.

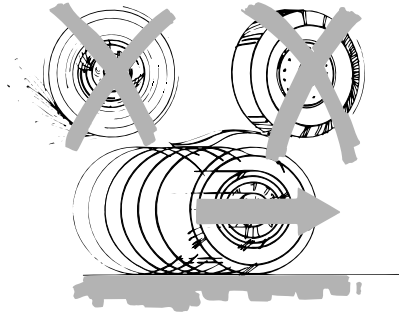

If your vehicle has anti-lock brakes, apply the brakes steadily. Do not “pump” the brakes.

### ***Driving on snow and ice***

Four-wheel drive vehicles have advantages over two-wheel drive vehicles in snow and ice but can skid like any other vehicle.

Should you start to slide while driving on snowy or icy roads, turn the steering wheel in the direction of the slide until you regain control.

Avoid sudden applications of power and quick changes of direction on snow and ice. Apply the accelerator slowly and steadily when starting from a full stop.

Avoid sudden braking as well. Although a four-wheel drive vehicle may accelerate better than a two-wheel drive vehicle in snow and ice, it won't stop any faster, because as in other vehicles, braking occurs at all four wheels. Do not become overconfident as to road conditions.

Make sure you allow sufficient distance between you and other vehicles for stopping. Drive slower than usual and consider using one of the lower gears. In emergency stopping situations, apply the brake forcefully and steadily. Do not “pump” the brakes. Refer to the *Brakes* section of this chapter for additional information on the operation of the anti-lock brake system.

## Driving

### **Tires, Replacement Requirements**



Do not use a size and type of tire and wheel other than that originally provided by Ford Motor Company because it can affect the safety and performance of your vehicle, which could result in an increased risk of loss of vehicle control, vehicle rollover and/or serious personal injury or death.

Make sure all road tires and road wheels on the vehicle are of the same size, type, tread design and load carrying capacity (for information on the spare tire, refer to *Changing the Tires* in the *Roadside emergencies* chapter). If you have questions regarding tire replacement, see an authorized Ford or Lincoln/Mercury dealer.

If you nevertheless decide to equip your four-wheel drive for off-road use with tires larger than what Ford Motor Company recommends, you should not use these tires for highway driving.

If you use any tire/wheel combination not recommended by Ford Motor Company, it may adversely affect vehicle handling and could cause steering, suspension, axle or transfer case failure as well as the increased risk of loss of vehicle control.

Do not use “aftermarket lift kits” or other suspension modifications, whether or not they are used with larger tires and wheels.

These “aftermarket lift kits” could adversely affect the vehicle’s handling characteristics, which could lead to loss of vehicle control or rollover and serious injury.

Tires can be damaged during off-road use. For your safety, tires that are damaged should not be used for highway driving because they are more likely to blow out or fail.

You should carefully observe the recommended tire inflation pressure found on the safety compliance certification label attached to the left front door latch post pillar (a label may also be found on the fuel cap filler door). Failure to follow tire pressure recommendations can adversely affect the way your vehicle handles. Do not exceed the Ford Motor Company recommended pressure even if it is less than the maximum pressure allowed for the tire.

## Driving

Each day before you drive, check your tires. If one looks lower than the others, use a tire gauge to check pressure of all tires, and adjust if required. Check tire pressure with a tire gauge monthly (including spare). Safe vehicle operation requires your tires to be set at the proper pressure and your vehicle not be overloaded.

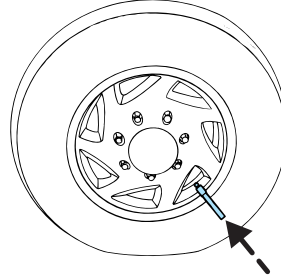

Periodically inspect the tire treads and remove stones, nails, glass or other objects that may be wedged in the tread grooves. Check for holes or cuts that may permit air leakage from the tire and make necessary repairs.

Inspect the tire sidewalls for cuts, bruises and other damage. If internal damage to the tire is suspected, have the tire demounted and inspected to determine whether it needs to be repaired or replaced.

### **Maintenance and Modifications**

The suspension and steering systems on your vehicle have been designed and tested to provide predictable performance whether loaded or empty and durable load carrying capability. For this reason, Ford Motor Company strongly recommends that you do not make modifications such as adding or removing parts (such as lift kits or stabilizer bars) or by using replacement parts not equivalent to the original factory equipment.

Any modifications to a vehicle that raise the center of gravity can make it more likely the vehicle will roll over as a result of a loss of control.

Ford Motor Company recommends that caution be used with any vehicle equipped with a high load or device (such as ladder racks or pickup box cover).

Failure to maintain your vehicle properly may void the warranty, increase your repair cost, reduce vehicle performance and operational capabilities and adversely affect driver and passenger safety. Frequent inspection of vehicle chassis components is recommended if the vehicle is subjected to heavy off-road usage.

### **DRIVING THROUGH WATER**

Do not drive quickly through standing water, especially if the depth is unknown. Traction or brake capability may be limited and if the ignition system gets wet, your engine may stall. Water may also enter your engine's air intake and severely damage your engine.

## Driving

If driving through deep or standing water is unavoidable, proceed very slowly. Never drive through water that is higher than the bottom of the hubs (for trucks) or the bottom of the wheel rims (for cars).

Once through the water, always try the brakes. Wet brakes do not stop the vehicle as effectively as dry brakes. Drying can be improved by moving your vehicle slowly while applying light pressure on the brake pedal.

**Driving through deep water where the transmission vent tube is submerged may allow water into the transmission and cause internal transmission damage. Have the fluid checked and, if water is found, replace the fluid.**

### VEHICLE LOADING – WITH AND WITHOUT A TRAILER

This section will guide you in the proper loading of your vehicle and/or trailer, to keep your loaded vehicle weight within its design rating capability, with or without a trailer. Properly loading your vehicle will provide maximum return of vehicle design performance. Before loading your vehicle, familiarize yourself with the following terms for determining your vehicle's weight ratings, with or without a trailer, from the vehicle's Safety Certification Label and Tire Label:

**Base Curb Weight** – is the weight of the vehicle including a full tank of fuel and all standard equipment. It does not include passengers, cargo, or optional equipment.

**Vehicle Curb Weight** – is the weight of your new vehicle when you picked it up from your dealer plus any aftermarket equipment.

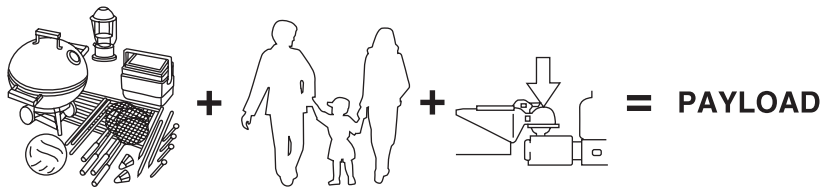

**Payload** – is the combined weight of cargo and passengers that the vehicle is carrying. The maximum payload for your vehicle can be found on the Tire Label on the driver's door or door pillar. Look for **“THE COMBINED WEIGHT OF OCCUPANTS AND CARGO SHOULD NEVER EXCEED XXX kg OR XXX lbs”** for maximum payload. The payload listed on the tire label is the maximum payload for the vehicle as built by the assembly plant. If any aftermarket or dealer installed equipment has been installed on the vehicle, the weight of the



## Driving

equipment must be subtracted from the payload listed on the tire label in order to determine the new payload.

 The appropriate loading capacity of your vehicle can be limited either by volume capacity (how much space is available) or by payload capacity (how much weight the vehicle should carry). Once you have reached the maximum payload of your vehicle, do not add more cargo, even if there is space available. Overloading or improperly loading your vehicle can contribute to loss of vehicle control and vehicle rollover.

EXAMPLE ONLY



**TIRE AND LOAD INFORMATION**  
SEE OWNERS MANUAL FOR ADDITIONAL INFORMATION

The combined weight of occupants and cargo should never exceed XXX kg or XXX lbs.

SEATING CAPACITY	TOTAL: 5	FRONT: 2	REAR: 3
------------------	----------	----------	---------

ORIGINAL TIRE SIZE		COLD TIRE INFLATION PRESSURE	
FRONT	P195 / 70R14	FRONT	200KPA, 29PSI
REAR	P195 / 70R14	REAR	200KPA, 29PSI
SPARE TIRE SIZE		COLD TIRE INFLATION PRESSURE	
T125/70D15		420KPA, 50PSI	

**TIRE AND LOAD INFORMATION**  
SEE OWNERS MANUAL FOR ADDITIONAL INFORMATION  
RENSEIGNEMENTS RELATIFS AUX PNEUS ET À LA CHARGE  
CONSULTER LE GUIDE DU PROPRIÉTAIRE POUR DE PLUS AMPLES RENSEIGNEMENTS

The combined weight of occupants and cargo should never exceed <sup>kg or</sup> XXX <sup>PM, kg ou</sup> XXX <sup>P.M., lb.</sup> lbs.

La charge du véhicule (occupants et bagages) ne doit jamais dépasser <sup>kg ou</sup> XXX <sup>P.M, kg ou</sup> XXX <sup>P.M., lb.</sup> lbs.

SEATING CAPACITY	TOTAL: TS	FRONT: FS	REAR: RS
NOMBRE DE PLACES	TOTAL:	AVANT:	ARRIÈRE:

ORIGINAL TIRE SIZE DIMENSIONS DES PNEUS D'ORIGINE		COLD TIRE INFLATION PRESSURE PRESSION DE GONFLAGE À FROID	
FRONT/ AVANT	FTIREXXXXXE	FRONT/ AVANT	FKPA KPA, FPS PSI
REAR/ ARRIÈRE	RTIREXXXXXE	REAR/ ARRIÈRE	RKPA KPA, RPS PSI
SPARE TIRE SIZE DIMENSION DU PNEU SECOURS		COLD TIRE INFLATION PRESSURE PRESSION DE GONFLAGE À FROID	
STIREXXXXXE		SKP KPA, SPS PSI	

## Driving

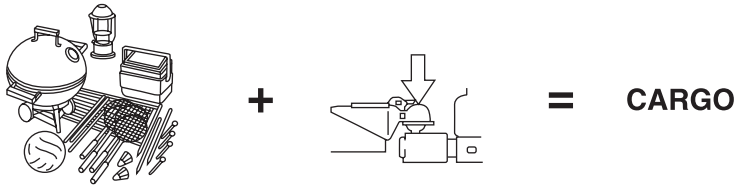

**Cargo Weight** – includes all weight added to the Base Curb Weight, including cargo and optional equipment. When towing, trailer tongue load or king pin weight is also part of cargo weight.

**GAW (Gross Axle Weight)** – is the total weight placed on each axle (front and rear) – including vehicle curb weight and all payload.

**GAWR (Gross Axle Weight Rating)** – is the maximum allowable weight that can be carried by a single axle (front or rear). **These numbers are shown on the Safety Compliance Certification Label located on the driver's door or door pillar. The total load on each axle must never exceed its GAWR.**

 Exceeding the Safety Certification Label axle weight rating limits could result in substandard vehicle handling, performance, engine, transmission and/or structural damage, serious damage to the vehicle, loss of control and personal injury.

**Note:** For trailer towing information refer to *Trailer towing* found in this chapter or the *RV and Trailer Towing Guide* provided by your dealership.

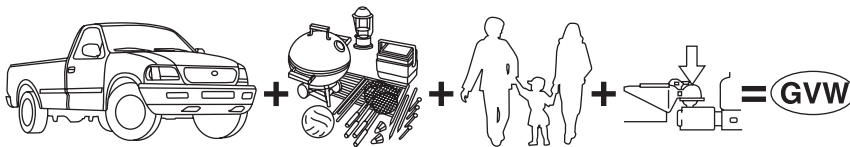

**GVW (Gross Vehicle Weight)** – is the Vehicle Curb Weight + cargo + passengers.

**GVWR (Gross Vehicle Weight Rating)** – is the maximum allowable weight of the fully loaded vehicle (including all options, equipment, passengers and cargo). **The GVWR is shown on the Safety Compliance Certification Label located on the driver’s door or door pillar. The GVW must never exceed the GVWR.**

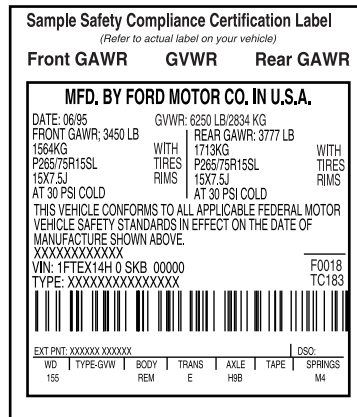

 Exceeding the Safety Certification Label axle weight rating limits could result in substandard vehicle handling, performance, engine, transmission and/or structural damage, serious damage to the vehicle, loss of control and personal injury.

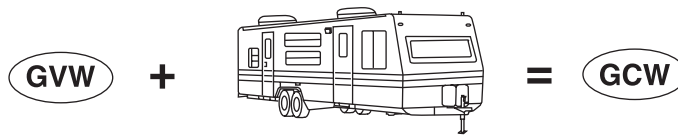

**GCW (Gross Combined Weight)** – is the weight of the loaded vehicle (GVW) plus the weight of the fully loaded trailer.

**GCWR (Gross Combined Weight Rating)** – is the maximum allowable weight of the vehicle and the loaded trailer – including all cargo and passengers – that the vehicle can handle without risking damage. (Important: The towing vehicle’s braking system is rated for operation at GVWR, not at GCWR. Separate functional brakes should be used for safe control of towed vehicles and for trailers where the GCW of the towing vehicle plus the trailer exceed the GVWR of the towing vehicle. **The GCW must never exceed the GCWR.**

**Maximum Loaded Trailer Weight** – is the highest possible weight of a fully loaded trailer the vehicle can tow. It assumes a vehicle with only mandatory options, no cargo (internal or external), a tongue load of

## Driving

10–15% (conventional trailer) or king pin weight of 15–25% (fifth wheel trailer), and driver only (150 lbs. [68 kg]). **Consult your dealership (or the *RV and Trailer Towing Guide* provided by your dealership) for more detailed information.**

**Tongue Load or Fifth Wheel King Pin Weight** – refers to the amount of the weight that a trailer pushes down on a trailer hitch.

**Examples:** For a 5,000 lbs. (2,268 kg) conventional trailer, multiply 5,000 by 0.10 and 0.15 to obtain a proper tongue load range of 500 to 750 lbs. (227 to 340 kg). For an 11,500 (5,216 kg) fifth wheel trailer, multiply by 0.15 and 0.25 to obtain a proper king pin load range of 1,725 to 2,875 (782 to 1,304 kg).



Do not exceed the GVWR or the GAWR specified on the certification label.



Do not use replacement tires with lower load carrying capacities than the originals because they may lower the vehicle's GVWR and GAWR limitations. Replacement tires with a higher limit than the originals do not increase the GVWR and GAWR limitations.



Exceeding any vehicle weight rating limitation could result in serious damage to the vehicle and/or personal injury.

### Steps for determining the correct load limit:

1. Locate the statement “The combined weight of occupants and cargo should never exceed XXX pounds” on your vehicle's label.
2. Determine the combined weight of the driver and passengers that will be riding in your vehicle.
3. Subtract the combined weight of the driver and passengers from XXX kilograms or XXX pounds.
4. The resulting figure equals the available amount of cargo and luggage load capacity. For example, if the “XXX” amount equals 1,400 lbs (635 kg) and there will be five 150 lbs. (68 kg) passengers in your vehicle, the amount of available cargo and luggage load capacity is 650 lbs. (1400–750 (5 x 150) = 650 lbs.). Metric conversion; 295 kg (635–340 (5 x 68) = 295 kg).
5. Determine the combined weight of luggage and cargo being loaded on the vehicle. That weight may not safely exceed the available cargo and luggage load capacity calculated in Step 4.

268

## Driving

6. If your vehicle will be towing a trailer, load from your trailer will be transferred to your vehicle. Consult this manual to determine how this reduces the available cargo and luggage load capacity of your vehicle.

### Special loading instructions for owners of pickup trucks and utility-type vehicles



For important information regarding safe operation of this type of vehicle, see the *Preparing to drive your vehicle* section in this chapter.



Loaded vehicles, with a higher center of gravity, may handle differently than unloaded vehicles. Extra precautions, such as slower speeds and increased stopping distance, should be taken when driving a heavily loaded vehicle.

Your vehicle has the capability to haul more cargo and people than most passenger cars. Depending upon the type and placement of the load, hauling cargo and people may raise the center of gravity of the vehicle.

### Calculating the load your vehicle can carry/tow

1. Use the appropriate maximum gross combined weight rating (GCWR) chart (in the *Trailer towing* section) to find the maximum GCWR for your type engine and rear axle ratio.
2. Weigh your vehicle as you customarily operate the vehicle without cargo. To obtain correct weights, try taking your vehicle to a shipping company or an inspection station for trucks.
3. Subtract your loaded vehicle weight from the maximum GCWR on the following charts. This is the maximum trailer weight your vehicle can tow and must fall below the maximum shown under maximum trailer weight on the chart.

### TRAILER TOWING

Trailer towing puts additional loads on your vehicle's engine, transmission, axle, brakes, tires, and suspension. For your safety and to maximize vehicle performance, be sure to use the proper equipment while towing.

Follow these guidelines to ensure safe towing:

- Stay within your vehicle's load limits.
- Thoroughly prepare your vehicle for towing. Refer to *Preparing to tow* in this chapter.

## Driving

- Use extra caution when driving while trailer towing. Refer to *Driving while you tow* in this chapter.
- Service your vehicle more frequently if you tow a trailer. Refer to the severe duty schedule in the scheduled maintenance guide.
- Do not tow a trailer until your vehicle has been driven at least 500 miles (800 km).
- Refer to the instructions included with towing accessories for the proper installation and adjustment specifications.

### **Trailer towing (standard equipment):**

Your vehicle is equipped with a integrated trailer hitch and a Class I (4-pin) trailer electrical connector. The 4-pin connector supplies power to tail lamps, stop lamps, and turn lamps. See the trailer towing chart for the trailer towing weight recommendation.

### **Trailer towing (optionally equipped trailer tow package):**

The optional trailer tow package includes heavy duty trailer tow wiring. Both a Class I (4-pin) and IV (7-pin) trailer electrical connector are provided. Under the instrument panel a electrical connector is provided for a customer supplied aftermarket electronic brake controller. For installing a customer supplied electronic brake controller, a electrical jumper harness and trailer tow electrical instructions are included with the optional trailer tow package.

The kit containing a electrical jumper and trailer tow electrical instructions may be purchased from any Ford, Lincoln, or Mercury dealership (Part number 4L1Z-14A348-AA)

**Note:** Before towing a trailer, make sure the trailer brakes (if equipped) and lamps are properly connected and functional. Electronic trailer brakes (if equipped) refer to the instructions provided by the aftermarket electronic brake controller manufacture for determining trailer brake functionality.

## Driving

Engine	Rear axle ratio	Maximum GCWR - lbs. (kg)	Trailer weight range (0 - maximum) - lbs. (kg)
<b>4x2</b>			
5.4L with standard trailer tow package	All	11900 (5397)	0-6000 (0-2721)
5.4L with optional trailer tow package	All	14500 (6576)	0-8600 (0-3900)
<b>4x4</b>			
5.4L with standard trailer tow package	All	12200 (5533)	0-6000 (0-2721)
5.4L with optional trailer tow package	All	14500 (6576)	0-8300 (0-3764)
<p><b>Note:</b> For vehicles not equipped with the optional trailer tow package, the maximum frontal area of trailer should not exceed the frontal area of the vehicle.</p> <p><b>Note:</b> For vehicles equipped with the optional trailer tow package, the maximum frontal area of trailer should not exceed 60 square feet (5.6 square meters).</p>			

Do not exceed the maximum loads listed on the Safety Compliance Certification label. For load specification terms found on the label, refer to *Vehicle loading* in this chapter. Remember to figure in the tongue load of your loaded trailer when figuring the total weight.



Towing trailers beyond the maximum recommended gross trailer weight exceeds the limit of the vehicle and could result in engine damage, transmission damage, structural damage, loss of control, vehicle rollover and personal injury.

## Driving

### INTEGRATED HITCH RATING

The standard integrated hitch has two ratings depending on mode of operation:

- **Weight carrying** - requires a draw bar and hitch ball. The draw bar supports all the vertical tongue load of the trailer.
- **Weight distributing** - requires an aftermarket weight distributing system which includes draw bar, hitch ball, spring bars and snap-up brackets. The vertical tongue load of the trailer is distributed between the truck and the trailer by this system.

Mode	Maximum Gross Trailer Weight - lbs. (kg)	Maximum Tongue Weight - lbs. (kg)
Weight carrying	6000 (2721)	600 (272)
Weight distributing	8850 (4014)	885 (401)

These are hitch ratings only; actual vehicle ratings are dependent on engine, transmission and axle combinations.



Towing trailers beyond the maximum tongue weight exceeds the limit of the towing system and could result in vehicle structural damage, loss of vehicle control and personal injury.

**Note:** If your vehicle is equipped with AdvanceTrac<sup>™</sup>, you may experience AdvanceTrac<sup>™</sup> activations during typical cornering maneuvers with a heavily loaded trailer; this is normal. Cornering at slower speeds while towing will reduce the tendency of the AdvanceTrac<sup>™</sup> stability enhancement system to activate.

### Trailer hitch cover

Your vehicle is equipped with a removable trailer hitch trim cover. To remove the trim cover:



## Driving

1. Loosen the two push pins in the bottom of the cover by turning them counterclockwise with a flathead screwdriver or similar object.

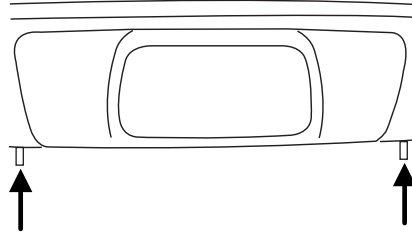

2. To reinstall the cover, insert the three plastic tabs into their slots (as shown in the illustration) and push the cover up into the bumper trim.

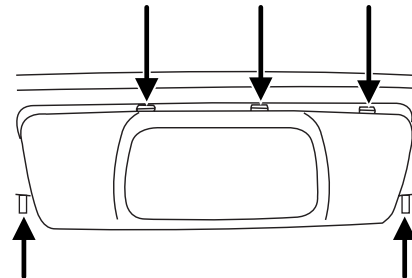

3. Hold the cover against the bumper trim and reinstall the two screws.

### Preparing to tow

Use the proper equipment for towing a trailer and make sure it is properly attached to your vehicle. See your dealer or a reliable trailer dealer if you require assistance.

### Hitches

Do not use hitches that clamp onto the vehicle's bumper or attach to the axle. You must distribute the load in your trailer so that 10%–15% of the total weight of the trailer is on the tongue.

### Load equalizing hitch

When hooking up a trailer using a load equalizing hitch, always use the following procedure:

1. Park the unloaded vehicle on a level surface. With the ignition in the ON position, apply the brake and place the gearshift lever in **D** (Overdrive) for 10 seconds, then return the gearshift lever to P (Park) and release the brake. With the ignition still in the ON position, and all doors closed, allow the vehicle to stand (without passengers) for several minutes so that it can level.

## Driving

2. Turn the air suspension (if equipped) control to OFF.
3. Measure the height of a reference point on the front and rear bumpers at the center of the vehicle.
4. Attach the trailer to the vehicle and adjust the hitch equalizers so that the front bumper height is within a ½ inch (0–13 mm) of the reference point. After proper adjustment, the rear bumper should be no higher than in Step 3.
5. Turn the air suspension (if equipped) control to ON.

**Note:** Adjusting an equalizing hitch so the rear bumper of the vehicle is higher than it was unloaded will defeat the function of the load equalizing hitch and may cause unpredictable handling.

### Safety chains

Always connect the trailer's safety chains to the frame or hook retainers of the vehicle hitch. To connect the trailer's safety chains, cross the chains under the trailer tongue and allow slack for turning corners.

If you use a rental trailer, follow the instructions that the rental agency gives to you.

**Do not attach safety chains to the bumper.**

### Trailer brakes

Electric brakes and manual, automatic or surge-type trailer brakes are safe if installed properly and adjusted to the manufacturer's specifications. The trailer brakes must meet local and Federal regulations.



Do not connect a trailer's hydraulic brake system directly to your vehicle's brake system. Your vehicle may not have enough braking power and your chances of having a collision greatly increase.

The braking system of the tow vehicle is rated for operation at the GVWR not GCWR.

### Trailer lamps

Trailer lamps are required on most towed vehicles. Make sure all running lights, brake lights, turn signals and hazard lights are working. See your dealer or trailer rental agency for proper instructions and equipment for hooking up trailer lamps.

### Driving while you tow

When towing a trailer:

- Turn off the speed control. The speed control may shut off automatically when you are towing on long, steep grades.
- Consult your local motor vehicle speed regulations for towing a trailer.
- To eliminate excessive shifting, use a lower gear. This will also assist in transmission cooling. (For additional information, refer to the *Understanding the positions of the 4-speed automatic transmission* section in this chapter.)
- Anticipate stops and brake gradually.
- Do not exceed the GCWR rating or transmission damage may occur.

### Servicing after towing

If you tow a trailer for long distances, your vehicle will require more frequent service intervals. Refer to your *Scheduled Maintenance Guide* for more information.

### Trailer towing tips

- Practice turning, stopping and backing up before starting on a trip to get the feel of the vehicle trailer combination. When turning, make wider turns so the trailer wheels will clear curbs and other obstacles.
- Allow more distance for stopping with a trailer attached.
- If you are driving down a long or steep hill, shift to a lower gear. Do not apply the brakes continuously, as they may overheat and become less effective.
- The trailer tongue weight should be 10–15% of the loaded trailer weight.
- After you have traveled 50 miles (80 km), thoroughly check your hitch, electrical connections and trailer wheel lug nuts.
- To aid in engine/transmission cooling and A/C efficiency during hot weather while stopped in traffic, place the gearshift lever in P (Park).
- Vehicles with trailers should not be parked on a grade. If you must park on a grade, place wheel chocks under the trailer's wheels.

### Launching or retrieving a boat

**Disconnect the wiring to the trailer before backing the trailer into the water. Reconnect the wiring to the trailer after the trailer is removed from the water.**

## Driving

When backing down a ramp during boat launching or retrieval:

- do not allow the static water level to rise above the bottom edge of the rear bumper.
- do not allow waves to break higher than 6 inches (15 cm) above the bottom edge of the rear bumper.

Exceeding these limits may allow water to enter vehicle components:

- causing internal damage to the components.
- affecting driveability, emissions and reliability.

Replace the rear axle lubricant any time the axle has been submerged in water. Rear axle lubricant quantities are not to be checked or changed unless a leak is suspected or repair required.

### **RECREATIONAL TOWING (ALL WHEELS ON THE GROUND)**

An example of recreational towing would be towing your vehicle behind a motorhome. Follow these guidelines if you have the need for recreational towing your vehicle with all four wheels on the ground. These guidelines are designed to ensure that your transmission is not damaged.

#### **2WD vehicles (with automatic transmissions):**

- Place the transmission in N (Neutral)
- Maximum speed is 35 mph (56 km/h)
- Maximum distance is 50 miles (80 km)

If a distance of 50 miles (80 km) or a speed of 35 mph (56 km/h) must be exceeded, the drive shaft will have to be removed before the vehicle is towed.

Ford recommends the driveshaft be removed/installed only by a qualified technician. See your local dealer for driveshaft removal/installation.

**Improper removal/installation of the driveshaft can cause transmission fluid loss, damage to the driveshaft and internal transmission components.**

#### **Vehicles equipped with Control Trac four-wheel drive system:**

Vehicles equipped with the Control Trac four-wheel drive system cannot be towed with any wheels on the ground. See your local dealer if you must flat-tow a vehicle equipped with the Control Trac four-wheel drive system.

## Roadside Emergencies

### GETTING ROADSIDE ASSISTANCE

To fully assist you should you have a vehicle concern, Ford Motor Company offers a complimentary roadside assistance program. This program is separate from the New Vehicle Limited Warranty. The service is available:

- 24-hours, seven days a week
- for the New Vehicle Limited Warranty period of three years or 36,000 miles (60,000 km), whichever occurs first on Ford and Mercury vehicles, and four years or 50,000 miles (80,000 km) on Lincoln vehicles.

Roadside assistance will cover:

- changing a flat tire
- jump-starts
- lock-out assistance
- limited fuel delivery
- towing of your disabled vehicle to the nearest Ford Motor Company dealership, or your selling dealer if within 35 miles (56.3 km) of the nearest Ford Motor Company dealership (one tow per disablement). Even non-warranty related tows, like accidents or getting stuck in the mud or snow, are covered (some exclusions apply, such as impound towing or repossession).

### Canadian customers refer to your Owner Information Guide for information on:

- coverage period
- exact fuel amounts
- towing of your disabled vehicle
- emergency travel expense reimbursement
- travel planning benefits

### USING ROADSIDE ASSISTANCE

Complete the roadside assistance identification card and place it in your wallet for quick reference. In the United States, this card is found in the Owner Guide portfolio in the glove compartment in Ford vehicles and is mailed to you if you own a Mercury or Lincoln. In Canada, the card is found in the Owner Information Guide in the glove compartment.

U.S. Ford or Mercury vehicle customers who require roadside assistance, call 1-800-241-3673; Lincoln vehicle customers call 1-800-521-4140.

## Roadside Emergencies

Canadian customers who require roadside assistance, call 1-800-665-2006.

If you need to arrange roadside assistance for yourself, Ford Motor Company will reimburse a reasonable amount. To obtain reimbursement information, U.S. Ford or Mercury vehicles customers call 1-800-241-3673; Lincoln vehicle customers call 1-800-521-4140.

Canadian customers who need to obtain reimbursement information, call 1-800-665-2006.

### ROADSIDE COVERAGE BEYOND BASIC WARRANTY

In the United States, you may purchase additional roadside assistance coverage beyond this period through the Ford Auto Club by contacting your Ford or Lincoln Mercury dealer.

Similarly in Canada, for uninterrupted Roadside Assistance coverage, you may purchase extended coverage prior to your Basic Warranty's Roadside Assistance expiring. For more information and enrollment, contact 1-877-294-2582 or visit our website at [www.ford.ca](http://www.ford.ca).

### HAZARD FLASHER

Use only in an emergency to warn traffic of vehicle breakdown, approaching danger, etc. The hazard flashers can be operated when the ignition is off.

- The hazard lights control is located on top of the steering column.
- Depress hazard lights control to activate all hazard flashers simultaneously.
- Depress control again to turn the flashers off.

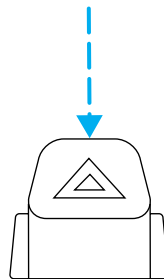

### FUEL PUMP SHUT-OFF SWITCH FUEL RESET

The fuel pump shut-off switch is a device intended to stop the electric fuel pump when your vehicle has been involved in a substantial jolt.

After a collision, if the engine cranks but does not start, the fuel pump shut-off switch may have been activated.

The fuel pump shut-off switch is located in the left rear quarter trim panel, near the liftgate. The switch is located behind an access panel.

## Roadside Emergencies

The fuel pump shut-off switch has a red reset button on top of it and is located beneath the air suspension switch (if equipped).

Use the following procedure to reset the fuel pump shut-off switch.

1. Turn the ignition to the OFF position.
2. Check the fuel system for leaks.
3. If no fuel leak is apparent, reset the fuel pump shut-off switch by pushing in on the reset button.
4. Turn the ignition to the ON position. Pause for a few seconds and return the key to the OFF position.
5. Make a further check for leaks in the fuel system.

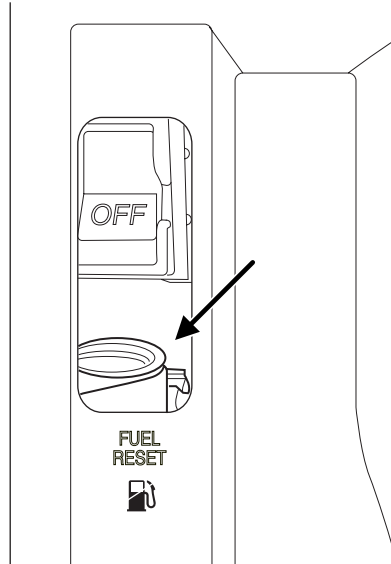

## FUSES AND RELAYS

### Fuses

If electrical components in the vehicle are not working, a fuse may have blown. Blown fuses are identified by a broken wire within the fuse. Check the appropriate fuses before replacing any electrical components.

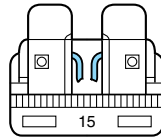

**Note:** Always replace a fuse with one that has the specified amperage rating. Using a fuse with a higher amperage rating can cause severe wire damage and could start a fire.

## Roadside Emergencies

### Standard fuse amperage rating and color

Fuse rating	COLOR				
	Mini fuses	Standard fuses	Maxi fuses	Cartridge maxi fuses	Fuse link cartridge
2A	Grey	Grey	—	—	—
3A	Violet	Violet	—	—	—
4A	Pink	Pink	—	—	—
5A	Tan	Tan	—	—	—
7.5A	Brown	Brown	—	—	—
10A	Red	Red	—	—	—
15A	Blue	Blue	—	—	—
20A	Yellow	Yellow	Yellow	Blue	Blue
25A	Natural	Natural	—	—	—
30A	Green	Green	Green	Pink	Pink
40A	—	—	Orange	Green	Green
50A	—	—	Red	Red	Red
60A	—	—	Blue	—	Yellow
70A	—	—	Tan	—	Brown
80A	—	—	Natural	—	Black

### Passenger compartment fuse panel / power distribution box

The fuse panel is located under the right-hand side of the instrument panel.

To remove the trim panel for access to the fuse box, pull the panel toward you and swing it out away from the side and remove it. To reinstall it, line up the tabs with the grooves on the panel, then push it shut.

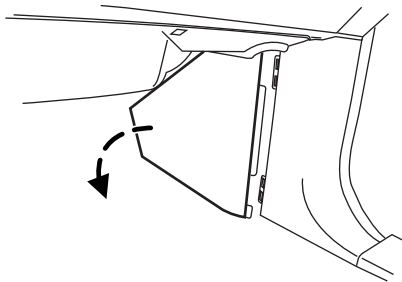



## Roadside Emergencies

To remove the fuse box cover, place a finger behind the PULL tab and your thumb above the PULL tab as shown in the illustration, then pull the cover off.

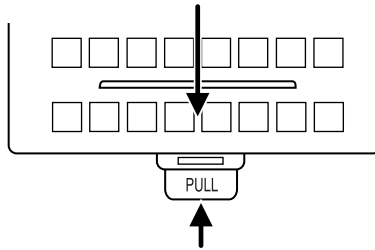

To reinstall the fuse box cover, place the top part of the cover on the fuse panel, then push the bottom part of the cover until you hear it click shut. Gently pull on the cover to make sure it is seated properly.

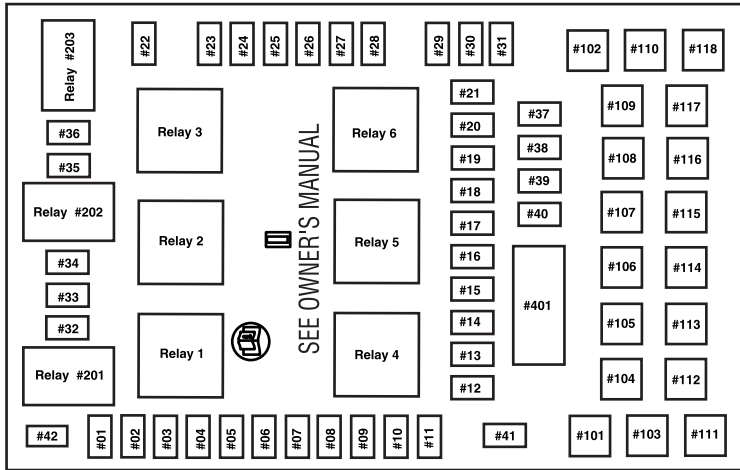

## Roadside Emergencies

The fuses are coded as follows.

Fuse/Relay Location	Fuse Amp Rating	Passenger Compartment Fuse Panel Description
1	10A*	Run/Accessory - Instrument cluster, Front wiper motor, Rear wiper motor, Tire Pressure Monitor System (TPMS) module
2	20A*	Brake On/Off (stoplamp) switch, Turn signal/Hazard flasher, AdvanceTrac <sup>™</sup> stoplamps relay (if equipped), Stoplamps, Center High-Mounted Stoplamp (CHMSL), Turn signal lamps
3	7.5A*	Power mirror switch, Memory module (logic power), Driver seat switch (memory)
4	15A*	Rear seat audio controls, Navigation module, DVD player
5	7.5A*	Brake On/Off (stoplamp) switch, Powertrain Control Module (PCM) (keep alive power), EATC control head, Body Security Module (BSM) (keep alive power), Speed control deactivation switch, Speed control servo, SecuriLock LED, 3rd row seat relay coils, Power liftgate module, Clock, Brake Shift Interlock (BSI) solenoid
6	15A*	Headlamp switch (parklamps and switch backlighting feed), Parklamps, License lamps, Foglamp relay coil, Trailer tow electric brake controller (illumination), BSM (autolamp parklamps), Floor console gear selector lighting, Switch backlighting module, Foglamp indicator
7	7.5A*	Radio (Start signal)

## Roadside Emergencies

<b>Fuse/Relay Location</b>	<b>Fuse Amp Rating</b>	<b>Passenger Compartment Fuse Panel Description</b>
8	10A*	Rear window defroster switch, Heated outside mirrors, Rear window defroster indicator (climate control head)
9	15A*	Fuel pump relay, Fuel pump shut-off switch, Fuel pump motor
10	20A*	Trailer tow back-up lamps relay, Trailer tow 7-wire connector (back-up lamps), Trailer tow parklamps relay, Trailer tow 7- and 4-wire connectors (parklamps)
11	10A*	A/C compressor clutch relay, A/C compressor clutch solenoid, Air suspension compressor relay, 4x4 Integrated Wheel Ends (IWE) solenoid
12	10A*	Speed control relay, Speed control servo
13	10A*	Rear window defroster relay coil, A/C refrigerant containment switch, A/C compressor thermistor, DEATC control head, DEATC solenoids, DEATC blower controller, Trailer tow battery charge relay coil
14	10A*	Daytime Running Lamps (DRL) ignition relay coil, Digital Transmission Range Sensor (DTRS back-up lamps), Trailer tow back-up lamps relay coil, Electrochromatic mirror
15	5A*	AdvanceTrac <sup>™</sup> switch, Instrument cluster (Run/Start feed)
16	10A*	ABS/AdvanceTrac <sup>™</sup> module (Run/Start feed)
17	15A*	Foglamps

## Roadside Emergencies

Fuse/Relay Location	Fuse Amp Rating	Passenger Compartment Fuse Panel Description
18	10A*	Auxiliary A/C temperature blend door actuator, Auxiliary A/C front auxiliary control, Park brake release relay coils, Turn signal flasher, Electrochromatic mirror, Auxiliary mode motor, Climate controlled seat modules
19	10A*	Restraints Control Module (RCM)
20	30A*	4x4 module, Air suspension module (air spring solenoids and height sensors)
21	15A*	Instrument cluster (B+), Interior (courtesy) lamps, TPMS module, Park brake release relays, Park brake release motor, Puddle lamps (outside mirrors)
22	10A*	Moonroof switch illumination, Flip window switch, Flip window relays, Flip window motors, Electronic hidden antenna amplifier (navigation radio), Radio (delayed accessory feed), Left front window motor, Navigation module
23	10A*	RH low beam
24	15A*	Interior demand lamps (front map/dome lamps, glove compartment lamp, cargo lamp, roof rail lamps, vanity mirror lamps), Battery saver relay coil, Battery saver relay power
25	10A*	LH low beam
26	20A*	Horn relay, Horns
27	5A*	Brake Shift Interlock solenoid, Overdrive cancel switch, Reverse park aid system module, Air suspension module (Run/Start), Compass module
28	5A*	PCM relay coil, Speed control relay coil, SecuriLock transceiver

## Roadside Emergencies

Fuse/Relay Location	Fuse Amp Rating	Passenger Compartment Fuse Panel Description
29	30A*	Trailer tow electric brake controller, Trailer tow 7-wire connector (electric brake)
30	30A*	BSM (door locks, liftgate glass release relay), Liftgate glass release motor, Left front window motor, Door/Liftgate lock motors
31	20A*	Radio (B+), Subwoofer, Navigation radio audio amplifier
32	15A*	Catalyst Monitor Sensors (CMS), Transmission solenoids
33	10A*	HEGO sensors, EGR vacuum regulator (EVR) solenoid, Canister vent solenoid, Vapor Management valve (VMV) solenoid, A/C compressor clutch relay coil
34	15A*	PCM, Idle Air Control (IAC) solenoid, Mass Air Flow (MAF) sensor, Fuel injectors
35	20A*	High beam headlamps, Instrument cluster high beam indicator
36	10A*	Trailer tow right turn/stop lamps
37	20A*	Cargo area power point
38	25A*	Rear wiper motor, Washer pump (rear window wash)
39	20A*	Console power points
40	20A*	DRL relays, DRL foglamps, DRL headlamp relay coil, Headlamp switch (headlamps), Multifunction switch (flash-to-pass), BSM (autolamp headlamps relay), High beam relay coil, Fuse 25 (LH low beam), Fuse 23 (RH low beam)

## Roadside Emergencies

Fuse/Relay Location	Fuse Amp Rating	Passenger Compartment Fuse Panel Description
41	20A*	Cigar lighter, OBD II diagnostic connector
42	10A*	Trailer tow left turn/stop lamps
101	30A**	Starter motor relay, Starter motor solenoid
102	30A**	Ignition switch power
103	30A**	ABS/AdvanceTrac™ module (pump motor)
104	30A**	LH 3rd row seat relay, LH 3rd row seat switch, LH 3rd row seat motor
105	30A**	Power liftgate module, Power liftgate motors, Power running boards control
106	30A**	Trailer tow battery charge relay, Trailer tow 7-wire connector (battery charge)
107	30A**	Auxiliary A/C blower relay, Auxiliary A/C blower motor
108	30A**	Passenger seat motor switch, Passenger seat lumbar switch and motor
109	30A**	Driver seat lumbar switch and motor, Memory module, Power memory mirrors, Adjustable pedals switch and motor
110	30A**	Power running boards
111	50A**	Air suspension compressor relay, Air suspension compressor
112	30A**	ABS/AdvanceTrac™ module (valves)
113	30A**	Front wiper motor, Washer pump (windshield wash)
114	40A**	Rear window defroster relay, Rear window defroster grid, Heated mirrors (Fuse 8)
115	30A**	4x4 module, Transfer case shift motor

## Roadside Emergencies

<b>Fuse/Relay Location</b>	<b>Fuse Amp Rating</b>	<b>Passenger Compartment Fuse Panel Description</b>
116	40A**	Front blower motor relay, Front blower motor
117	30A**	RH 3rd row seat relay, RH 3rd row seat switch, RH 3rd row seat motor
118	30A**	Driver and passenger climate control seat module
401	30A CB (circuit breaker)	Power windows (circuit breaker), Main window switch, Window motors, Window switches, Moonroof module
R01	Starter relay	Starter motor solenoid
R02	Delayed accessory relay	Fuse 22, CB 401, Power windows, Moonroof, Flip windows, Radio, Navigation module, Navigation antenna amplifier
R03	Hi-beam relay	Fuse 35, Hi-beam headlamps, Hi-beam indicator
R04	Rear window defrost relay	Fuse 8 (heated mirrors), Rear window defroster, Heated outside mirrors, Rear window defroster indicator (climate control head)
R05	Trailer tow battery charge relay	Trailer tow 7-wire connector (battery charge)
R06	Front blower relay	Front blower motor
R201	Trailer tow park lamp relay	Trailer tow 7- and 4-wire connectors (park lamps)
R202	Foglamp relay	Front foglamps
R203	PCM relay	Fuse 32, Fuse 33, Fuse 34, Fuel pump relay, PCM solenoids and sensors
R301	Trailer tow back-up lamp relay	Trailer tow 7-wire connector (back-up lamps)

## Roadside Emergencies

Fuse/Relay Location	Fuse Amp Rating	Passenger Compartment Fuse Panel Description
R302	Speed control relay	Speed control servo
R303	Fuel pump relay	Fuel pump shut-off switch, PCM (fuel pump monitor), Fuel pump
R304	Battery saver relay	Roof rail lamps, Vanity mirror lamps, Map/Dome lamp, Glove box lamp, Cargo area lamp, Outside mirror puddle lamps, Instrument cluster (interior lamps)
R305	Horn relay	Dual note horn
* Mini Fuses ** Maxi Fuses		

**Note:** Relays R301–R305 are not serviceable components; see your dealer or a qualified technician for assistance.

### CHANGING THE TIRES

If you get a flat tire while driving, do not apply the brake heavily. Instead, gradually decrease your speed. Hold the steering wheel firmly and slowly move to a safe place on the side of the road.



The use of tire sealants may damage your tires. The use of tire sealants may also damage your tire pressure monitoring system (if equipped).

Your vehicle may be equipped with a conventional spare tire that is different in one or more of the following: type, brand, size, speed rating and tread design. If this is the case, this dissimilar spare tire is still rated for your vehicle loads (GAWR and GVWR). Your vehicle is equipped with a spare wheel that does not match the road wheels and is not equipped with a Tire Pressure Monitor System (TPMS) sensor.

### Dissimilar spare tire/wheel information



Failure to follow these guidelines could result in an increased risk of loss of vehicle control, injury or death.

Your vehicle may be equipped with a dissimilar spare tire/wheel. A dissimilar spare tire/wheel is defined as a spare tire and/or wheel that is different in brand, size or appearance from the road tires and wheels. If



## Roadside Emergencies

you have a dissimilar spare tire/wheel, then it is intended for temporary use only. This means that if you need to use it, you should replace it as soon as possible with a road tire/wheel that is the same size and type as the road tires and wheels that were originally provided by Ford. If the dissimilar spare tire or wheel is damaged, it should be replaced rather than repaired.

When driving with the dissimilar spare tire/wheel, **do not:**

- Exceed 70 mph (113 km/h)
- Use more than one dissimilar spare tire/wheel at a time
- Use commercial car washing equipment
- Use snow chains on the end of the vehicle with the dissimilar spare tire/wheel

The usage of a dissimilar spare tire/wheel can lead to impairment of the following:

- Handling, stability and braking performance
- Comfort and noise
- Ground clearance and parking at curbs
- Winter weather driving capability
- Wet weather driving capability
- All-Wheel Driving Capability (if applicable)
- Load Leveling Adjustment (if applicable)

When driving with the dissimilar spare tire/wheel additional caution should be given to:

- Towing a trailer
- Driving vehicles equipped with a camper body
- Driving vehicles with a load on the cargo rack

Drive cautiously when using a dissimilar spare tire/wheel and seek service as soon as possible.

### Spare tire information

**Note:** If your vehicle is equipped with the tire pressure monitoring system (TPMS), the system indicator light will illuminate when the spare is in use. To restore the full functionality of the monitoring system, all road wheels equipped with tire pressure monitoring sensors must be mounted on the vehicle

If your vehicle is equipped with TPMS, have a flat tire serviced by a dealer or qualified technician in order to prevent damage to the TPMS sensor. Replace the spare tire with a road tire as soon as possible.

## Roadside Emergencies

### **Location of the spare tire and tools**

The spare tire and tools for your vehicle are stowed in the following locations:

<b>Item</b>	<b>Location</b>
Spare tire	Under the vehicle, just forward of the rear bumper
Jack tools and jacking instructions	Under the access panel located in the floor compartment behind the rear seat

### **Removing the jack and tools**

1. Open the liftgate, then locate the access panel on the floor behind the 3rd row seat. Unlatch and remove the panel.
2. Remove the jack and tools assembly tray from the compartment by turning the wing-nut counterclockwise to relieve tension against the jack assembly tray.
3. Unsnap the wheel lug nut wrench, jack extension and handle from the plastic tray. Remove the jack and instruction sheet from the tray assembly.

### **Removing the spare tire**

1. Fold the rear seat down. Refer to *Rear seats* in the *Seating and safety restraints* chapter.
2. Remove the jack handle and winch extension from the tray and assemble them.
3. Open the spare tire winch access plug in the bottom of the compartment located behind the 3rd row seat, very close to the jack and tools tray.
4. Insert the winch extension tool assembly through the access hole in the floor and engage the winch.
5. To remove the spare tire, turn the handle counterclockwise until the tire is lowered to the ground and the cable is slightly slack.
6. Slide the retainer through the center of the spare tire wheel.

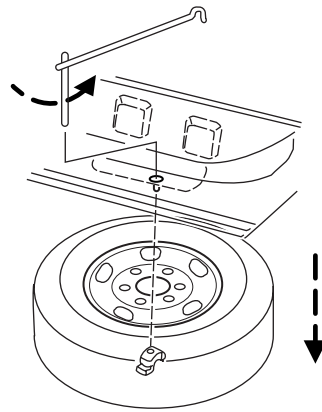

## Roadside Emergencies

### Tire change procedure

 To help prevent the vehicle from moving when you change a tire, be sure the parking brake is set, then block (in both directions) the wheel that is diagonally opposite (other side and end of the vehicle) to the tire being changed.

 If the vehicle slips off the jack, you or someone else could be seriously injured.

 On vehicles equipped with Air Suspension, turn OFF the Air Suspension switch prior to jacking, hoisting or towing your vehicle.

Refer to *Air suspension* in the *Driving* chapter for instructions on turning the system off.

Refer to the instruction sheet (located in the rear floor compartment behind the 3rd row seat with the jack tray tools assembly kit) for detailed tire change instructions.

1. Park on a level surface, activate hazard flashers and set the parking brake.

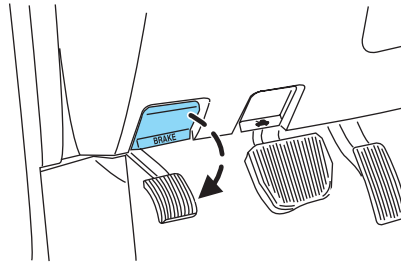

2. Place gearshift lever in P (Park), turn engine OFF and block the diagonally opposite wheel. (If changing the tire on a grade, block the diagonally opposite wheel on the downward side of the grade.)

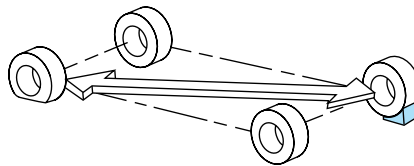

## Roadside Emergencies

3. Obtain the spare tire and jack from their storage locations. Turn off the air suspension switch (the air suspension switch is located behind a trim panel on the left rear quarter trim panel. Refer to *Air Suspension System* in the *Driving* section for more information.). Also, turn OFF the deployable running boards (if equipped. See *Message center* in the *Driver controls* section).

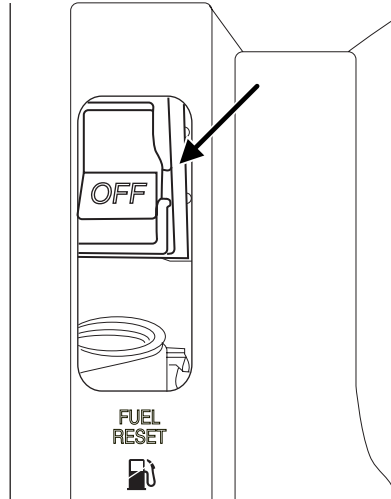

4. Use the tip of the jack handle to remove any wheel trim. Loosen each wheel lug nut one-half turn counterclockwise but do not remove them until the wheel is raised off the ground.

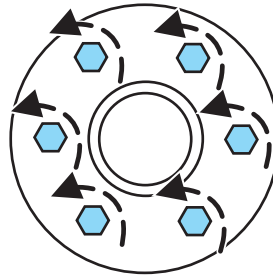

5. Position the jack according to the jack locator arrows found on the frame and turn the jack handle and extension tool assembly clockwise.

**Note:** Use the frame rail as the jacking point, NOT the control arm.

6. Lift the vehicle so the tire is no further than 1 inch (2.5 cm) off the ground when installing the spare tire.

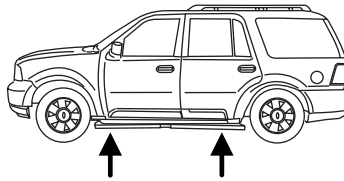

## Roadside Emergencies

 When one of the rear wheels is off the ground, the transmission alone will not prevent the vehicle from moving or slipping off the jack, even if the transmission is in P (Park). To prevent the vehicle from moving when you change the tire, be sure that the parking brake is set and the diagonally opposite wheel is blocked. If the vehicle slips off the jack, someone could be seriously injured.

- Front

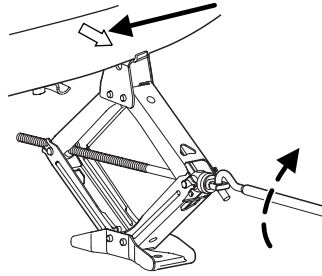

- Rear

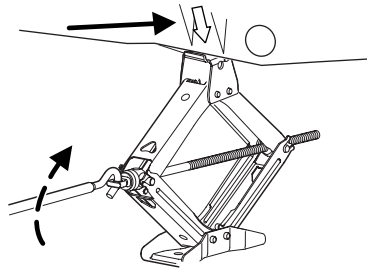

 Turn off the running boards before jacking or placing any object under the vehicle. Never place your hand between the extended running board and the vehicle. A moving running board may cause injury.

## Roadside Emergencies

- **Never use the front or rear differential as a jacking point.**

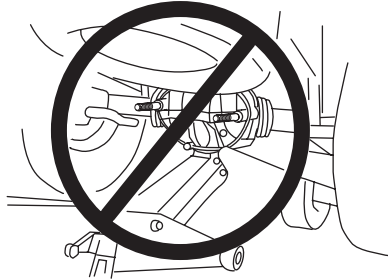

To lessen the risk of personal injury, do not put any part of your body under the vehicle while changing a tire. Do not start the engine when your vehicle is on the jack. The jack is only meant for changing the tire.

7. Remove the lug nuts with the lug wrench.
8. Replace the flat tire with the spare tire, making sure the valve stem is facing outward. Reinstall the lug nuts until the wheel is snug against the hub. Do not fully tighten the lug nuts until the wheel has been lowered.
9. Lower the wheel by turning the jack handle counterclockwise.
10. Remove the jack and fully tighten the lug nuts in the order shown and reinstall the wheel cover.
11. Unblock the wheels.
12. Put flat tire, jack, lug wrench and tools away. Make sure the jack is fastened securely so it does not rattle when you drive.
13. Turn on the air suspension switch (if equipped).

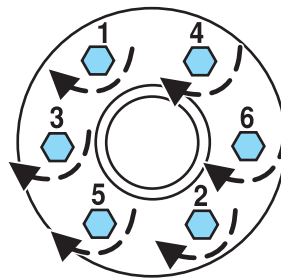

### **Stowing the spare tire**

1. Lay the tire on the ground, near the rear of the vehicle, with the valve stem side facing up.

## Roadside Emergencies

2. Slide the wheel partially under the vehicle and install the retainer through the wheel center. After doing so, pull on the cable to align the components at the end of the cable.

3. Assemble the jack handle and winch extension (as shown in illustration), then insert the winch extension through the access hole behind the 3rd row seat and engage the winch.

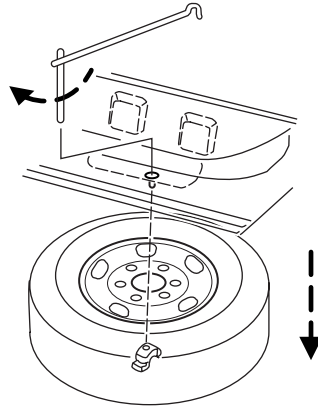

4. Turn the jack handle clockwise until the tire is raised to its stowed position underneath the vehicle. The wrench will become harder to turn and the spare tire winch will ratchet or slip when the tire is raised to maximum tightness. A clicking sound will be heard from the winch indicating that the tire is properly stowed.

5. Disassemble the tools and snap them back into the tool tray. Close the access hole with the rubber plug. Reinstall the tray into the vehicle and secure it with the wing nut (turn clockwise until tight).

### Wheel lug nut torque specifications

Retighten the lug nuts to the specified torque at 500 miles (800 km) after any wheel disturbance (tire rotation, changing a flat tire, wheel removal, etc.).

Bolt size	Wheel lug nut torque*	
	lb.ft.	N•m
M14 x 2.0	150	200

\* Torque specifications are for nut and bolt threads free of dirt and rust. Use only Ford recommended replacement fasteners.



When a wheel is installed, always remove any corrosion, dirt or foreign materials present on the mounting surfaces of the wheel or the surface of the front disc brake hub and rotor that contacts the wheel. Installing wheels without correct metal-to-metal contact at the wheel mounting surfaces can cause the wheel nuts to loosen and the wheel to come off while the vehicle is in motion, resulting in loss of control.

## Roadside Emergencies

### JUMP STARTING YOUR VEHICLE



The gases around the battery can explode if exposed to flames, sparks, or lit cigarettes. An explosion could result in injury or vehicle damage.



Batteries contain sulfuric acid which can burn skin, eyes and clothing, if contacted.

**Do not attempt to push-start your vehicle. Automatic transmissions do not have push-start capability; doing so may damage the catalytic converter.**

### Preparing your vehicle

When the battery is disconnected or a new battery is installed, the transmission must relearn its shift strategy. As a result, the transmission may have firm and/or soft shifts. This operation is considered normal and will not affect function or durability of the transmission. Over time, the adaptive learning process will fully update transmission operation.

1. **Use only a 12-volt supply to start your vehicle.**
2. Do not disconnect the battery of the disabled vehicle as this could damage the vehicle's electrical system.
3. Park the booster vehicle close to the hood of the disabled vehicle making sure the two vehicles **do not** touch. Set the parking brake on both vehicles and stay clear of the engine cooling fan and other moving parts.
4. Check all battery terminals and remove any excessive corrosion before you attach the battery cables. Ensure that vent caps are tight and level.
5. Turn the heater fan on in both vehicles to protect any electrical surges. Turn all other accessories off.



## Roadside Emergencies

### Connecting the jumper cables

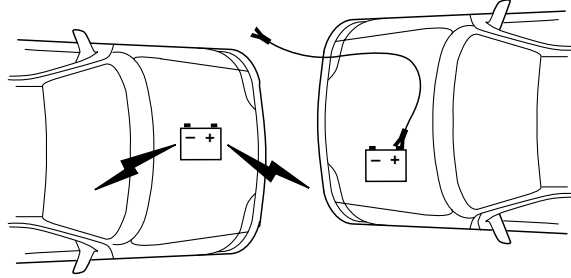

1. Connect the positive (+) jumper cable to the positive (+) terminal of the discharged battery.

**Note:** In the illustrations, *lightning bolts* are used to designate the assisting (boosting) battery.

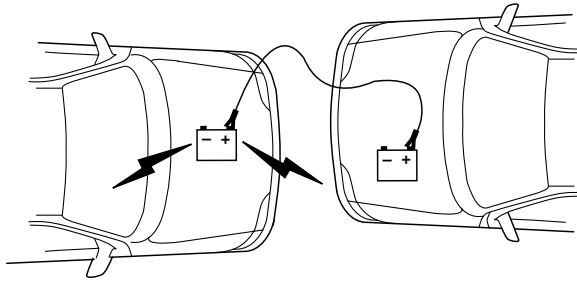

2. Connect the other end of the positive (+) cable to the positive (+) terminal of the assisting battery.

## Roadside Emergencies

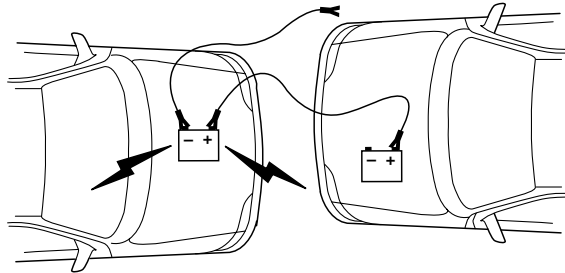

3. Connect the negative (-) cable to the negative (-) terminal of the assisting battery.

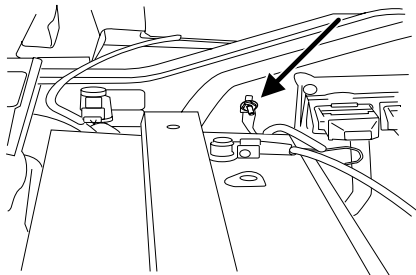
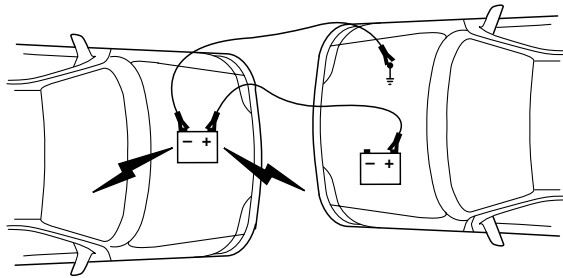

4. Make the final connection of the negative (-) cable to the jump starting stud located in the rear of the engine compartment, near the battery. **Do not** use fuel lines, engine rocker covers or the intake manifold as *grounding* points.

## Roadside Emergencies



Do not connect the end of the second cable to the negative (-) terminal of the battery to be jumped. A spark may cause an explosion of the gases that surround the battery.

5. Ensure that the cables are clear of fan blades, belts, moving parts of both engines, or any fuel delivery system parts.

### Jump starting

1. Start the engine of the booster vehicle and run the engine at moderately increased speed.
2. Start the engine of the disabled vehicle.
3. Once the disabled vehicle has been started, run both engines for an additional three minutes before disconnecting the jumper cables.

### Removing the jumper cables

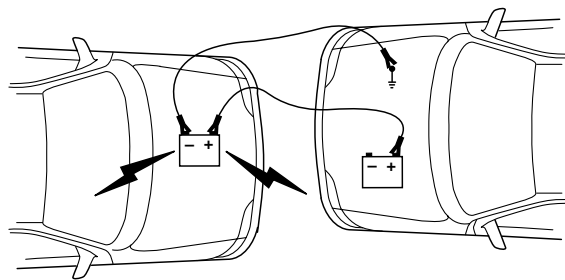

**Remove the jumper cables in the reverse order that they were connected.**

1. Remove the jumper cable from the *ground* metal surface.

**Note:** In the illustrations, *lightning bolts* are used to designate the assisting (boosting) battery.

## Roadside Emergencies

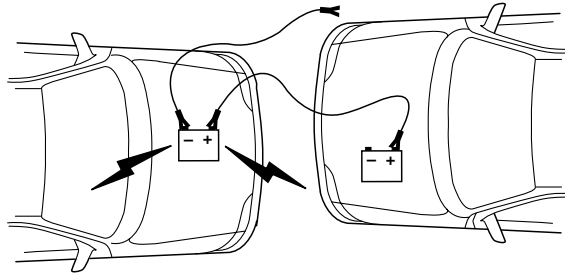

2. Remove the jumper cable on the negative (-) connection of the booster vehicle's battery.

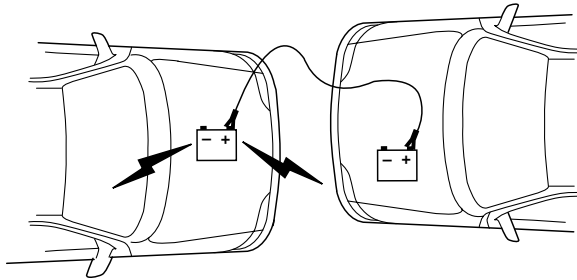

3. Remove the jumper cable from the positive (+) terminal of the booster vehicle's battery.

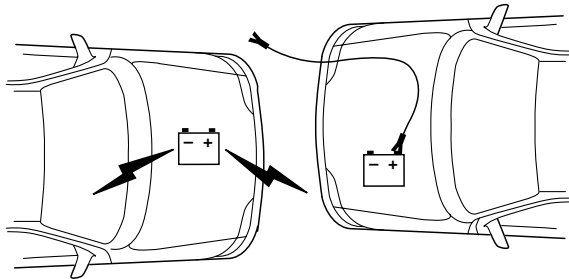

4. Remove the jumper cable from the positive (+) terminal of the disabled vehicle's battery.

After the disabled vehicle has been started and the jumper cables removed, allow it to idle for several minutes so the engine computer can *relearn* its idle conditions.

300

## Roadside Emergencies

### WRECKER TOWING

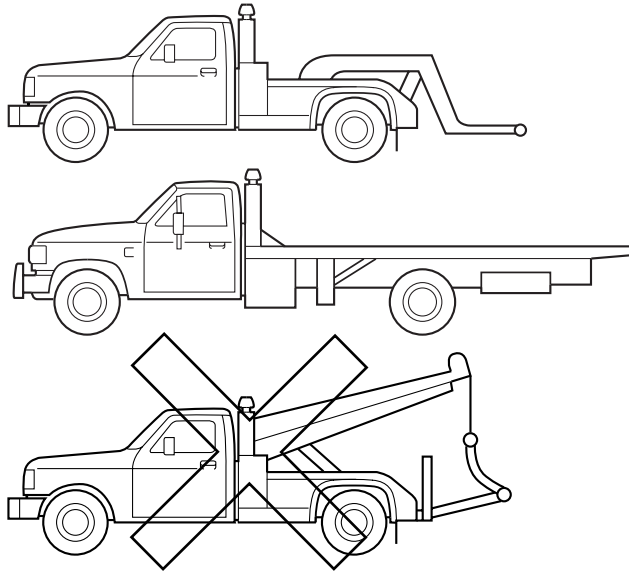

If you need to have your vehicle towed, contact a professional towing service or, if you are a member of a roadside assistance program, your roadside assistance service provider.

It is recommended that your vehicle be towed with a wheel lift or flatbed equipment. Do not tow with a slingbelt. Ford Motor Company has not approved a slingbelt towing procedure. Also, wrecker towing the vehicle by the front frame-mounted tow hooks is not recommended or advised.

**The air suspension control and the ignition must be turned off before being towed. Refer to *Air suspension in the Driving* chapter.**

On 4x2 vehicles, it is acceptable to tow the vehicle with the front wheels on the ground (without dollies) and the rear wheels off the ground.

On 4x4 vehicles, it is recommended that your vehicle be towed with a wheel lift and dollies or flatbed equipment with all the wheels off the ground.

**If the vehicle is towed by other means or incorrectly, vehicle damage may occur.**

## Roadside Emergencies

With a disabled vehicle (without access to wheel dollies, car hauling trailer or flatbed transport vehicle) your vehicle can be towed (all wheels on the ground) under the following conditions:

**Special Conditions:**

- Release the parking brake.
- Turn the air suspension control to OFF.
- Turn the ignition to the OFF/UNLOCKED position.
- Place the transmission in N (Neutral).

If the vehicle's battery is discharged, refer to *Automatic transmission operation* in the *Driving* chapter for directions on how to move the gearshift lever out of the P (Park) position, for proper towing.

- Do not exceed a distance of 50 miles (80 km).
- Do not exceed 35 mph (56 km/h) vehicle speed.

Ford Motor Company produces a towing manual for all authorized tow truck operators. Have your tow truck operator refer to this manual for proper hook-up and towing procedures for your vehicle.

## Customer Assistance

### GETTING THE SERVICES YOU NEED

#### At home

You must take your Lincoln or Mercury vehicle to an authorized Lincoln Mercury dealer for warranty repairs. While any Ford, Lincoln or Mercury dealership handling your vehicle line will provide warranty service, we recommend you return to your selling dealer who wants to ensure your continued satisfaction. Please note that certain warranty repairs require special training and/or equipment, so not all dealers are authorized to perform all warranty repairs. This means that, depending on the warranty repair needed, you may have to take your vehicle to another dealer. A reasonable time must be allowed to perform a repair after taking your vehicle to the dealership. Repairs will be made using Ford or Motorcraft parts, or remanufactured or other parts that are authorized by Ford.

If you have questions or concerns, or are unsatisfied with the service you are receiving, follow these steps:

1. Contact your Sales Representative or Service Advisor at your selling/servicing dealership.
2. If your inquiry or concern remains unresolved, contact the Sales Manager, Service Manager or Customer Relations Manager.
3. If you require assistance or clarification on Ford Motor Company policies or procedures, please contact the Ford Customer Relationship Center at the number below.

#### Away from home

If you own a Ford or Mercury vehicle and are away from home when your vehicle needs service, or if you need more help than the dealership could provide, after following the steps described above, contact the Ford Customer Relationship Center to find an authorized dealership to help you.

In the United States:

Ford Motor Company  
Customer Relationship Center  
P.O. Box 6248  
Dearborn, MI 48121  
1-800-392-3673 (FORD)  
(TDD for the hearing impaired: 1-800-232-5952)  
[www.customersaskford.com](http://www.customersaskford.com)

## Customer Assistance

In Canada:  
Customer Relationship Centre  
Ford Motor Company of Canada, Limited  
P.O. Box 2000  
Oakville, Ontario L6J 5E4  
1-800-565-3673 (FORD)  
[www.ford.ca](http://www.ford.ca)

If you own a Lincoln vehicle and are away from home when your vehicle needs service, or if you need more help than the dealership could provide, after following the steps described above, contact the Ford Customer Relationship Center to find an authorized dealership to help you.

In the United States:  
Ford Motor Company  
Customer Relationship Center  
P.O. Box 6248  
Dearborn, MI 48121  
1-800-521-4140  
(TDD for the hearing impaired: 1-800-232-5952)  
[www.customersaskford.com](http://www.customersaskford.com)

In Canada:  
Lincoln Centre  
Ford Motor Company of Canada, Limited  
P.O. Box 2000  
Oakville, Ontario L6J 5E4  
1-800-387-9333  
[www.lincolncanada.com](http://www.lincolncanada.com)

In order to help you service your Lincoln vehicle, please have the following information available when contacting the Lincoln Centre:

- Your telephone number (home and business)
- The name of the dealer and the city where the dealership is located
- The year and make of your vehicle
- The date of vehicle purchase
- The current odometer reading
- The vehicle identification number (VIN)

If you still have a complaint involving a warranty dispute, you may wish to contact the Dispute Settlement Board (U.S.).

In some states (in the U.S.) you must directly notify Ford in writing before pursuing remedies under your state's warranty laws. Ford is also allowed a final repair attempt in some states.



## Customer Assistance

In the United States, a warranty dispute must be submitted to the Dispute Settlement Board before taking action under the Magnuson-Moss Warranty Act, or to the extent allowed by state law, before pursuing replacement or repurchase remedies provided by certain state laws. This dispute handling procedure is not required prior to enforcing state created rights or other rights which are independent of the Magnuson-Moss Warranty Act or state replacement or repurchase laws.

### **FORD EXTENDED SERVICE PLAN**

You can get more protection for your new car or light truck by purchasing Ford Extended Service Plan (Ford ESP) coverage. It provides the following:

- Benefits during the warranty period depending on the plan you purchase (such as: reimbursement for rentals; coverage for certain maintenance and wear items).
- Protection against covered repair costs after your Bumper-to-Bumper Warranty expires.

You may purchase Ford ESP from any participating Ford and Lincoln Mercury and Ford of Canada dealer. There are several plans available in various time, distance and deductible combinations which can be tailored to fit your own driving needs. Ford ESP also offers reimbursement benefits for towing and rental coverage.

When you buy Ford ESP, you receive Peace-of-Mind protection throughout the United States and Canada, provided by a network of more than 5,000 participating Ford or Lincoln Mercury and Ford of Canada dealers.

If you did not take advantage of the Ford Extended Service Plan at the time of purchasing your vehicle, you may still be eligible. Since this information is subject to change, please ask your dealer for complete details about Ford Extended Service Plan coverage options, or visit the Ford ESP website at [www.ford-esp.com](http://www.ford-esp.com).

### **THE DISPUTE SETTLEMENT BOARD (U.S. ONLY)**

The Dispute Settlement Board is:

- an independent, third-party arbitration program for warranty disputes.
- available free to owners and lessees of qualifying Ford Motor Company vehicles.

The Dispute Settlement Board may not be available in all states. Ford Motor Company reserves the right to change eligibility limitations, modify

## Customer Assistance

procedures and/or to discontinue this service without notice and without incurring obligations per applicable state law.

### What kinds of cases does the Board review?

Unresolved warranty repair concerns or vehicle performance concerns as on Ford and Lincoln Mercury cars and Ford and Lincoln Mercury light trucks which are within the terms of any applicable written new vehicle warranty are eligible for review, except those involving:

- a non-Ford product
- a non-Ford dealership
- sales disputes between customer and dealer except those associated with warranty repairs or concerns with the vehicle's performance as designed
- a request for reimbursement of consequential expenses unless a service or product concern is being reviewed
- items not covered by the New Vehicle Limited Warranty (including maintenance and wear items)
- alleged personal injury/property damage claims
- cases currently in litigation
- vehicles not used primarily for family, personal or household purposes (except in states where the Dispute Settlement Board is required to review commercial vehicles)
- vehicles with non-U.S. warranties

Concerns are ineligible for review if the New Vehicle Limited Warranty has expired at receipt of your application and, in certain states eligibility is dependent upon the customer's possession of the vehicle.

Eligibility may differ according to state law. For example, see the unique brochures for California, West Virginia, Georgia and Wisconsin purchasers/lessees.

### Board membership

The Board consists of:

- Three consumer representatives
- A Ford or Lincoln Mercury dealership representative

Consumer candidates for Board membership are recruited and trained by an independent consulting firm. The dealership Board member is chosen from Ford and Lincoln Mercury dealership management, recognized for their business leadership qualities.

306

## Customer Assistance

### ***What the Board needs***

To have your case reviewed you must complete the application in the DSB brochure and mail it to the address provided on the application form. Some states will require you to use certified mail, with return receipt requested.

Your application is reviewed and, if it is determined to be eligible, you will receive an acknowledgment indicating:

- The file number assigned to your application.
- The toll-free phone number of the DSB's independent administrator.

Your dealership and a Ford Motor Company representative will then be asked to submit statements.

To properly review your case, the Board needs the following information:

- Legible copies of all documents and maintenance or repair orders relevant to the case.
- The year, make, model, and Vehicle Identification Number (VIN) listed on your vehicle ownership license.
- The date of repair(s) and mileage at the time of occurrence(s).
- The current mileage.
- The name of the dealer(s) who sold or serviced the vehicle.
- A brief description of your unresolved concern.
- A brief summary of the action taken by the dealer(s) and Ford Motor Company.
- The names (if known) of all the people you contacted at the dealership(s).
- A description of the action you expect to resolve your concern.

You will receive a letter of explanation if your application does not qualify for Board review.

### ***Oral presentations***

If you would like to make an oral presentation, indicate YES to question 6 on the application. While it is your right to make an oral presentation before the Board, this is not a requirement and the Board will decide the case whether or not an oral presentation is made. An oral presentation may be requested by the Board as well.

### ***Making a decision***

Board members review all available information related to each complaint, including oral presentations, and arrive at a fair and impartial decision. Board review may be terminated at any time by either party.

## Customer Assistance

Every effort is made to decide the case within 40 days of the date that all requested information is received by the Board. Since the Board generally meets once a month, it may take longer for the Board to consider some cases.

After a case is reviewed, the Board mails you a decision letter and a form on which to accept or reject the Board's decision. The decisions of the Board are binding on Ford (and, in some cases, on the dealer) but not on consumers who are free to pursue other remedies available to them under state or federal law.

### To request a DSB Brochure/Application

For a brochure/application, speak to your dealer or write/call the Board at the following address/phone number:

Dispute Settlement Board  
P.O. Box 1424  
Waukesha, WI 53187-1424  
1-800-428-3718

You may also contact the North American Customer Relationship Center at 1-800-392-3673 (Ford), TDD for the hearing impaired: 1-800-232-5952 or by writing to the Center at the following address:

Ford Motor Company  
Customer Relationship Center  
P.O. Box 6248  
Dearborn, Michigan 48121

### UTILIZING THE MEDIATION/ARBITRATION PROGRAM (CANADA ONLY)

In those cases where you continue to feel that the efforts by Ford and the dealer to resolve a factory-related vehicle service concern have been unsatisfactory, Ford of Canada participates in an impartial third party mediation/arbitration program administered by the Canadian Motor Vehicle Arbitration Plan (CAMVAP).

The CAMVAP program is a straight-forward and relatively speedy alternative to resolve a disagreement when all other efforts to produce a settlement have failed. This procedure is without cost to you and is designed to eliminate the need for lengthy and expensive legal proceedings.

In the CAMVAP program, impartial third-party arbitrators conduct hearings at mutually convenient times and places in an informal environment. These impartial arbitrators review the positions of the

## Customer Assistance

parties, make decisions and, when appropriate, render awards to resolve disputes. CAMVAP decisions are fast, fair, and final; the arbitrator's award is binding both to you and Ford of Canada.

CAMVAP services are available in all territories and provinces. For more information, without charge or obligation, call your CAMVAP Provincial Administrator directly at 1-800-207-0685.

### **GETTING ASSISTANCE OUTSIDE THE U.S. AND CANADA**

Before exporting your vehicle to a foreign country, contact the appropriate foreign embassy or consulate. These officials can inform you of local vehicle registration regulations and where to find unleaded fuel.

If you cannot find unleaded fuel or can only get fuel with an anti-knock index lower than is recommended for your vehicle, contact a district or owner relations/customer relationship office.

The use of leaded fuel in your vehicle without proper conversion may damage the effectiveness of your emission control system and may cause engine knocking or serious engine damage. Ford Motor Company/Ford of Canada is not responsible for any damage caused by use of improper fuel.

In the United States, using leaded fuel may also result in difficulty importing your vehicle back into the U.S.

If your vehicle must be serviced while you are traveling or living in Central or South America, the Caribbean, or the Middle East, contact the nearest Ford dealership. If the dealership cannot help you, write or call:

FORD MOTOR COMPANY  
WORLDWIDE DIRECT MARKET OPERATIONS  
1555 Fairlane Drive  
Fairlane Business Park #3  
Allen Park, Michigan 48101  
U.S.A.  
Telephone: (313) 594-4857  
FAX: (313) 390-0804

If you are in another foreign country, contact the nearest Ford dealership. If the dealership employees cannot help you, they can direct you to the nearest Ford affiliate office.

If you buy your vehicle in North America and then relocate outside of the U.S. or Canada, register your vehicle identification number (VIN) and new address with Ford Motor Company Worldwide Direct Market Operations.

## Customer Assistance

### ORDERING ADDITIONAL OWNER'S LITERATURE

To order the publications in this portfolio, contact Helm, Incorporated at:

HELM, INCORPORATED  
P.O. Box 07150  
Detroit, Michigan 48207

Or call:

**For a free publication catalog, order toll free: 1-800-782-4356**

Monday-Friday 8:00 a.m. - 6:00 p.m. EST

Helm, Incorporated can also be reached by their website:  
[www.helminc.com](http://www.helminc.com).

*(Items in this catalog may be purchased by credit card, check or money order.)*

### Obtaining a French owner's guide

French Owner's Guides can be obtained from your dealer or by writing to Ford Motor Company of Canada, Limited, Service Publications, P.O. Box 1580, Station B, Mississauga, Ontario L4Y 4G3.

### IN CALIFORNIA (U.S. ONLY)

California Civil Code Section 1793.2(d) requires that, if a manufacturer or its representative is unable to repair a motor vehicle to conform to the vehicle's applicable express warranty after a reasonable number of attempts, the manufacturer shall be required to either replace the vehicle with one substantially identical or repurchase the vehicle and reimburse the buyer in an amount equal to the actual price paid or payable by the consumer (less a reasonable allowance for consumer use). The consumer has the right to choose whether to receive a refund or replacement vehicle.

California Civil Code Section 1793.22(b) presumes that the manufacturer has had a reasonable number of attempts to conform the vehicle to its applicable express warranties if, within the first 18 months of ownership of a new vehicle or the first 18,000 miles (29,000 km), whichever occurs first:

1. Two or more repair attempts are made on the same non-conformity likely to cause death or serious bodily injury OR
2. Four or more repair attempts are made on the same nonconformity (a defect or condition that substantially impairs the use, value or safety of the vehicle) OR

310

*2004 Navigator (nav)*  
*Owners Guide (post-2002-fmt)*  
*USA English (fus)*

## Customer Assistance

3. The vehicle is out of service for repair of nonconformities for a total of more than 30 calendar days (not necessarily all at one time)

In the case of 1 or 2 above, the consumer must also notify the manufacturer of the need for the repair of the nonconformity at the following address:

Ford Motor Company  
16800 Executive Plaza Drive  
Mail Drop 3NE-B  
Dearborn, MI 48126

### REPORTING SAFETY DEFECTS (U.S. ONLY)

If you believe that your vehicle has a defect which could cause a crash or could cause injury or death, you should immediately inform the National Highway Traffic Safety



Administration (NHTSA) in addition to notifying Ford Motor Company.

If NHTSA receives similar complaints, it may open an investigation, and if it finds that a safety defect exists in a group of vehicles, it may order a recall and remedy campaign. However, NHTSA cannot become involved in individual problems between you, your dealer, or Ford Motor Company.

To contact NHTSA, you may either call the Auto Safety Hotline toll-free at 1-800-424-9393 (or 366-0123 in the Washington D.C. area) or write to:

NHTSA  
400 Seventh Street  
U.S. Department of Transportation  
Washington, D.C. 20590

You can also obtain other information about motor vehicle safety from the Hotline.

## Cleaning

### WASHING THE EXTERIOR

Wash your vehicle regularly with cool or lukewarm water and a neutral Ph shampoo, such as Motorcraft Detail Wash (ZC-3-A), which is available from your dealer.

- Never use strong household detergents or soap, such as dish washing or laundry liquid. These products can discolor and spot painted surfaces.
- Never wash a vehicle that is “hot to the touch” or during exposure to strong, direct sunlight.
- Always use a clean sponge or car wash mitt with plenty of water for best results.
- Dry the vehicle with a chamois or soft terry cloth towel in order to eliminate water spotting.
- It is especially important to wash the vehicle regularly during the winter months, as dirt and road salt are difficult to remove and cause damage to the vehicle.
- Immediately remove items such as gasoline, diesel fuel, bird droppings and insect deposits because they can cause damage to the vehicle’s paintwork and trim over time.
- Remove any exterior accessories, such as antennas, before entering a car wash.
- **Suntan lotions and insect repellents can damage any painted surface; if these substances come in contact with your vehicle, wash off as soon as possible.**
- **If your vehicle is equipped with running boards, do not use rubber, plastic and vinyl protectant products on the running board surface, as the area may become slippery.**
- **If your vehicle is equipped with power deployable running boards, you may experience noise while deploying the system due to excessive grit and grime buildup. While the system is unaffected by this buildup, it is important to wash the area regularly in order to maintain the system’s optimal operation.**

### WAXING

Applying a polymer paint sealant to your vehicle every six months will assist in reducing minor scratches and paint damage.

- Wash the vehicle first.
- Do not use waxes that contain abrasives.



## Cleaning

- Do not allow paint sealant to come in contact with any non-body (low-gloss black) colored trim, such as grained body-side cladding, roof racks, bumper step surfaces, mirror housings or the windshield cowl area. The paint sealant will “gray” or stain the parts over time.

### PAINT CHIPS

Your dealer has touch-up paint and sprays to match your vehicle’s color. Take your color code (printed on a sticker in the driver’s door jam) to your dealer to ensure you get the correct color.

- Remove particles such as bird droppings, tree sap, insect deposits, tar spots, road salt and industrial fallout before repairing paint chips.
- Always read the instructions before using the products.

### ALUMINUM WHEELS AND WHEEL COVERS

Aluminum wheels and wheel covers are coated with a clearcoat paint finish. In order to maintain their shine:

- Clean weekly with Motorcraft Wheel and Tire Cleaner (ZC-37-A), which is available from your dealer. Heavy dirt and brake dust accumulation may require agitation with a sponge. Rinse thoroughly with a strong stream of water.
- Never apply any cleaning chemical to hot or warm wheel rims or covers.
- Some automatic car washes may cause damage to the finish on your wheel rims or covers. Chemical-strength cleaners, or cleaning chemicals, in combination with brush agitation to remove brake dust and dirt, could wear away the clearcoat finish over time.
- Do not use hydrofluoric acid-based or high caustic-based wheel cleaners, steel wool, fuels or strong household detergent.
- To remove tar and grease, use Motorcraft Bug and Tar Remover (ZC-42), available from your dealer.

### ENGINE

Engines are more efficient when they are clean because grease and dirt buildup keep the engine warmer than normal. When washing:

- Take care when using a power washer to clean the engine. The high-pressure fluid could penetrate the sealed parts and cause damage.
- Do not spray a hot engine with cold water to avoid cracking the engine block or other engine components.

## Cleaning

- Spray Motorcraft Engine Shampoo and Degreaser (ZC-20) on all parts that require cleaning and pressure rinse clean.



- Cover the highlighted areas to prevent water damage when cleaning the engine.
- Never wash or rinse the engine while it is running; water in the running engine may cause internal damage.

### PLASTIC (NON-PAINTED) EXTERIOR PARTS

Use only approved products to clean plastic parts. These products are available from your dealer.

- For routine cleaning, use Motorcraft Detail Wash (ZC-3-A).
- If tar or grease spots are present, use Motorcraft Bug and Tar Remover (ZC-42).

### WINDOWS AND WIPER BLADES

The windshield, rear and side windows and the wiper blades should be cleaned regularly. If the wipers do not wipe properly, substances on the vehicle's glass or the wiper blades may be the cause. These may include hot wax treatments used by commercial car washes, tree sap, or other organic contamination. To clean these items, please follow these tips:

- The windshield, rear windows and side windows may be cleaned with a non-abrasive cleaner such as Motorcraft Ultra Clear Spray Glass Cleaner (ZC-23), available from your dealer.
- Do not use abrasives, as they may cause scratches.

## Cleaning

- Do not use fuel, kerosene, or paint thinner to clean any parts.
- Wiper blades can be cleaned with isopropyl (rubbing) alcohol or windshield washer solution. Be sure to replace wiper blades when they appear worn or do not function properly.

**Do not use sharp objects, such as a razor blade, to clean the inside of the rear window or to remove decals, as it may cause damage to the rear window defroster's heated grid lines.**

### INSTRUMENT PANEL AND CLUSTER LENS

Clean the instrument panel with a damp cloth, then dry with a dry cloth.

- Avoid cleaners or polish that increase the gloss of the upper portion of the instrument panel. The dull finish in this area helps protect the driver from undesirable windshield reflection.



Do not use chemical solvents or strong detergents when cleaning the steering wheel or instrument panel to avoid contamination of the air bag system.

- Be certain to wash or wipe your hands clean if you have been in contact with certain products such as insect repellent and suntan lotion in order to avoid possible damage to the interior painted surfaces.

### INTERIOR

For fabric, carpets, cloth seats and safety belts:

- Remove dust and loose dirt with a vacuum cleaner.
- Remove light stains and soil with Motorcraft Extra Strength Upholstery Cleaner (ZC-41).
- If grease or tar is present on the material, spot-clean the area first with Motorcraft Spot and Stain Remover (ZC-14).
- Never saturate the seat covers with cleaning solution.
- Do not use household cleaning products or glass cleaners, which can stain and discolor the fabric and affect the flame retardant abilities of the seat materials.



Do not use cleaning solvents, bleach or dye on the vehicle's seatbelts, as these actions may weaken the belt webbing.

## Cleaning

### **CLEANING THE CLIMATE CONTROLLED SEATS (IF EQUIPPED)**

Remove dust and loose dirt with a whisk broom or a vacuum cleaner. Remove fresh spots immediately. Clean the seat with a damp cloth, using a mild soap and water solution, if necessary.

### **LEATHER SEATS**

Your leather seating surfaces have a clear, protective coating over the leather.

- To clean, use a soft cloth with Motorcraft Deluxe Leather and Vinyl Cleaner (ZC-11-A). Dry the area with a soft cloth.
- To help maintain its resiliency and color, use the Motorcraft Deluxe Leather Care Kit (ZC-11-D), available from your authorized dealer.
- Do not use household cleaning products, alcohol solutions, solvents or cleaners intended for rubber, vinyl and plastics, or oil/petroleum-based leather conditioners. These products may cause premature wearing of the clear, protective coating.

**Note:** In some instances, color or dye transfer can occur when wet clothing comes in contact with leather upholstery. If this occurs, the leather should be cleaned immediately to avoid permanent staining.

### **INTERIOR TRIM**

- Clean the interior trim areas with a damp cloth, then dry by wiping with a dry, soft, clean cloth.
- Do not use household or glass cleaners as these may damage the finish.

### **UNDERBODY**

Flush the complete underside of your vehicle frequently. Keep body and door drain holes free from packed dirt.

### **FORD, LINCOLN AND MERCURY CAR CARE PRODUCTS**

Your Ford, Lincoln or Mercury dealer has many quality products available to clean your vehicle and protect its finishes. These quality products have been specifically engineered to fulfill your automotive needs; they are custom designed to complement the style and appearance of your vehicle. Each product is made from high quality materials that meet or exceed rigid specifications. For best results, use the following products or products of equivalent quality:

- Motorcraft Custom Clearcoat Polish (ZC-8-A)
- Motorcraft Custom Vinyl Protectant (not available in Canada) (ZC-40-A)
- Motorcraft Vinyl Cleaner (Canada only) (CXC-93)
- Motorcraft Vinyl Conditioner (Canada only) (CXC-94)
- Motorcraft Deluxe Leather and Vinyl Cleaner (not available in Canada) (ZC-11-A)
- Motorcraft Bug and Tar Remover (ZC-42)
- Motorcraft Extra Strength Upholstery Cleaner (not available in Canada) (ZC-41)
- Motorcraft Custom Bright Metal Cleaner (ZC-15)
- Motorcraft Wheel and Tire Cleaner (ZC-37-A)
- Motorcraft Dash and Vinyl Cleaner (ZC-38-A)
- Motorcraft Car Care Kit (ZC-26)
- Ford Premium Car Wash Concentrate (F2SZ-19523-WC)
- Motorcraft Carlite Glass Cleaner (Canada only) (CXC-100)
- Motorcraft Spot and Stain Remover (ZC-14)
- Motorcraft Detail Wash (ZC-3-A)
- Motorcraft Tire Clean and Shine (ZC-28)
- Motorcraft Triple Clean (ZC-13)
- Motorcraft Ultra-Clear Spray Glass Cleaner (not available in Canada) (ZC-23)
- Motorcraft Engine Shampoo and Degreaser (ZC-20)

## Maintenance and Specifications

### SERVICE RECOMMENDATIONS

To help you service your vehicle:

- We highlight do-it-yourself items in the engine compartment for easy location.
- We provide a scheduled maintenance guide which makes tracking routine service easy.

If your vehicle requires professional service, your dealership can provide the necessary parts and service. Check your *Warranty Guide/Owner Information Guide* to find out which parts and services are covered.

Use only recommended fuels, lubricants, fluids and service parts conforming to specifications. Motorcraft parts are designed and built to provide the best performance in your vehicle.

### PRECAUTIONS WHEN SERVICING YOUR VEHICLE

- Do not work on a hot engine.
- Make sure that nothing gets caught in moving parts.
- Do not work on a vehicle with the engine running in an enclosed space, unless you are sure you have enough ventilation.
- Keep all open flames and other lit material away from the battery and all fuel related parts.

#### Working with the engine off

1. Set the parking brake and shift to P (Park).
2. Turn off the engine and remove the key.
3. Block the wheels.

#### Working with the engine on

1. Set the parking brake and shift to P (Park).
2. Block the wheels.

**Note:** Do not start your engine with the air cleaner removed and do not remove it while the engine is running.

## Maintenance and Specifications

### OPENING THE HOOD

1. Inside the vehicle, pull the hood release handle located under the bottom left corner of the instrument panel.

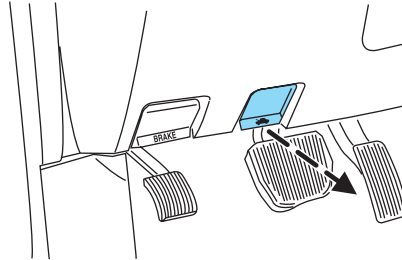

2. Go to the front of the vehicle and release the auxiliary latch located under the front of the hood, just above the passenger side headlamp. Slide the yellow handle to release the auxiliary latch.

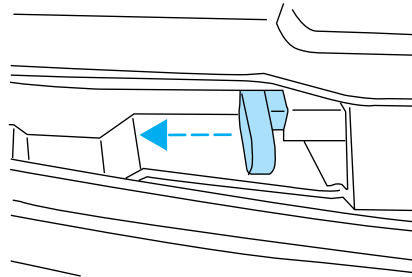

3. Lift the hood until the lift cylinders hold it open.

## Maintenance and Specifications

### IDENTIFYING COMPONENTS IN THE ENGINE COMPARTMENT

#### 5.4L 4V V8 engine

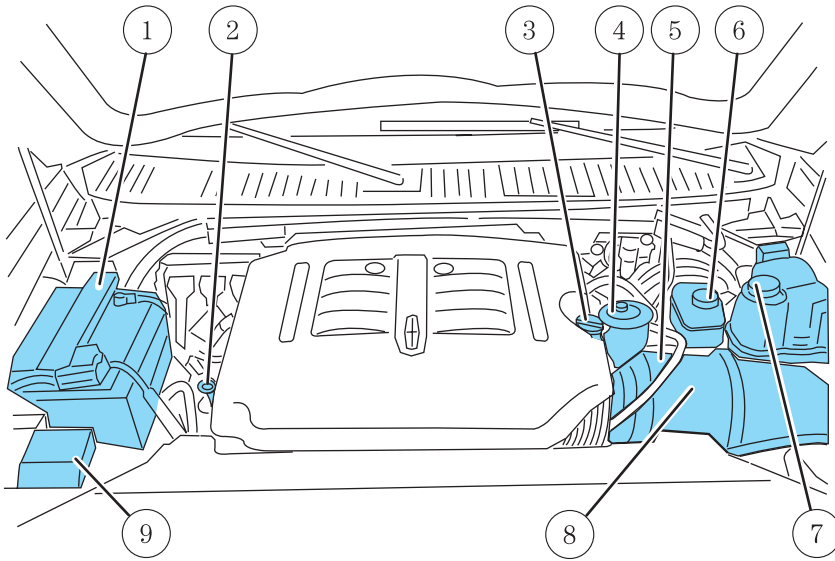

1. Battery
2. Automatic transmission fluid dipstick
3. Engine oil filler cap
4. Power steering fluid reservoir
5. Engine oil dipstick
6. Brake fluid reservoir
7. Engine coolant reservoir
8. Air filter assembly
9. Windshield washer fluid reservoir



## Maintenance and Specifications

### WINDSHIELD WASHER FLUID

Add fluid to fill the reservoir if the level is low. In very cold weather, do not fill the reservoir completely.

Only use a washer fluid that meets Ford specification WSB-M8B16-A2. Refer to *Lubricant specifications* in this chapter.

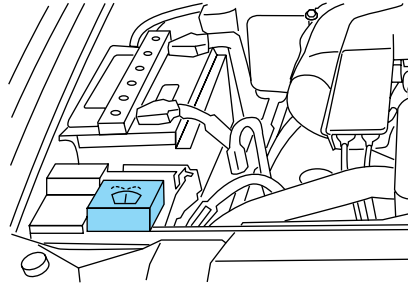

State or local regulations on volatile organic compounds may restrict the use of methanol, a common windshield washer antifreeze additive. Washer fluids containing non-methanol antifreeze agents should be used only if they provide cold weather protection without damaging the vehicle's paint finish, wiper blades or washer system.



If you operate your vehicle in temperatures below 4.5° C (40° F), use washer fluid with antifreeze protection. Failure to use washer fluid with antifreeze protection in cold weather could result in impaired windshield vision and increase the risk of injury or accident.

**Note:** Do not put washer fluid in the engine coolant reservoir. Washer fluid placed in the cooling system may harm engine and cooling system components.

### Checking and adding washer fluid for the liftgate

Washer fluid for the liftgate is supplied by the same reservoir as the windshield.

### ENGINE OIL

#### Checking the engine oil

Refer to the scheduled maintenance guide for the appropriate intervals for checking the engine oil.

1. Make sure the vehicle is on level ground.
2. Turn the engine off and wait a few minutes for the oil to drain into the oil pan.
3. Set the parking brake and ensure the gearshift is securely latched in P (Park).

## Maintenance and Specifications

4. Open the hood. Protect yourself from engine heat.
5. Locate and carefully remove the engine oil level indicator (dipstick).

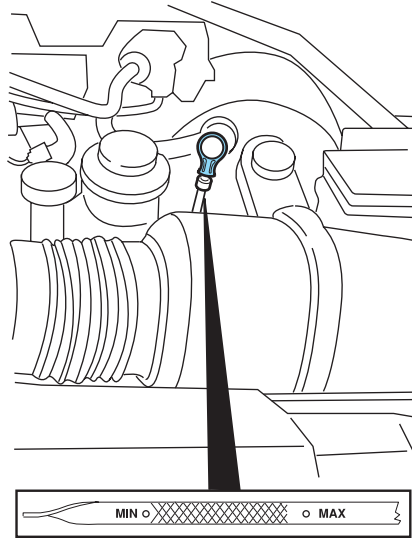

6. Wipe the indicator clean. Insert the indicator fully, then remove it again.

- If the oil level is **between the MIN and MAX marks**, the oil level is acceptable. **DO NOT ADD OIL.**
- If the oil level is below the MIN mark, add enough oil to raise the level within the MIN-MAX range.

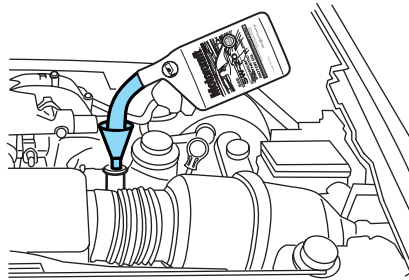

- Oil levels above the MAX mark may cause engine damage. Some oil must be removed from the engine by a service technician.

7. Put the indicator back in and ensure it is fully seated.

322

## Maintenance and Specifications

### Adding engine oil

1. Check the engine oil. For instructions, refer to *Checking the engine oil* in this chapter.
2. If the engine oil level is not within the normal range, add only certified engine oil of the recommended viscosity. Remove the engine oil filler cap and use a funnel to pour the engine oil into the opening.
3. Recheck the engine oil level. Make sure the oil level is not above the MAX mark on the engine oil level indicator (dipstick).
4. Install the indicator and ensure it is fully seated.
5. Fully install the engine oil filler cap by turning the filler cap clockwise 1/4 of a turn until the cap is fully seated.

**To avoid possible oil loss, DO NOT operate the vehicle with the engine oil level indicator and/or the engine oil filler cap removed.**

### Engine oil and filter recommendations

Look for this certification trademark.

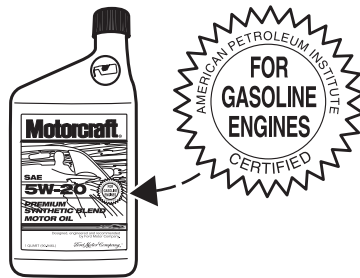

### Use SAE 5W-20 engine oil.

Only use oils “Certified For Gasoline Engines” by the American Petroleum Institute (API). To protect your engine’s warranty use Motorcraft SAE 5W-20 or an equivalent 5W-20 oil meeting Ford specification WSS-M2C153-H. **SAE 5W-20 oil provides optimum fuel economy and durability performance meeting all requirements for your vehicle’s engine.**

Do not use supplemental engine oil additives, cleaners or other engine treatments. They are unnecessary and could lead to engine damage that is not covered by Ford warranty.

Change your engine oil and filter according to the appropriate schedule listed in the scheduled maintenance guide.

Ford production and aftermarket (Motorcraft) oil filters are designed for added engine protection and long life. If a replacement oil filter is used

## Maintenance and Specifications

that does not meet Ford material and design specifications, start-up engine noises or knock may be experienced.

It is recommended you use the appropriate Motorcraft oil filter (or another brand meeting Ford specifications) for your engine application.

### **BATTERY**

Your vehicle is equipped with a Motorcraft maintenance-free battery which normally does not require additional water during its life of service.

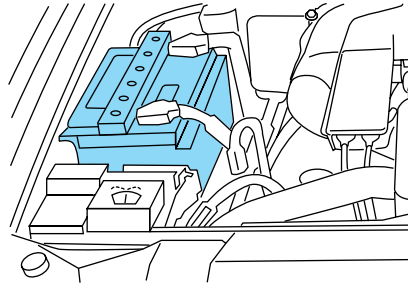

However, for severe usage or in high temperature climates, check the battery electrolyte level. Refer to the *Scheduled Maintenance Guide* for the service interval schedules.

**Keep the electrolyte level in each cell up to the “level indicator”. Do not overfill the battery cells.**

If the electrolyte level in the battery is low, you can add plain tap water to the battery, as long as you do not use hard water (water with a high mineral or alkali content). If possible, however, try to only fill the battery cells with distilled water. If the battery needs water often, have the charging system checked.

**If your battery has a cover/shield, make sure it is reinstalled after the battery has been cleaned or replaced.**

For longer, trouble-free operation, keep the top of the battery clean and dry. Also, make certain the battery cables are always tightly fastened to the battery terminals.

If you see any corrosion on the battery or terminals, remove the cables from the terminals and clean with a wire brush. You can neutralize the acid with a solution of baking soda and water.

When the battery is disconnected or a new battery installed, the transmission must learn its adaptive strategy. As a result of this, the transmission may shift firmly. This operation is considered normal and will fully update transmission operation to its optimum shift feel.

## Maintenance and Specifications

 Batteries normally produce explosive gases which can cause personal injury. Therefore, do not allow flames, sparks or lighted substances to come near the battery. When working near the battery, always shield your face and protect your eyes. Always provide proper ventilation.

 When lifting a plastic-cased battery, excessive pressure on the end walls could cause acid to flow through the vent caps, resulting in personal injury and/or damage to the vehicle or battery. Lift the battery with a battery carrier or with your hands on opposite corners.

 Keep batteries out of reach of children. Batteries contain sulfuric acid. Avoid contact with skin, eyes or clothing. Shield your eyes when working near the battery to protect against possible splashing of acid solution. In case of acid contact with skin or eyes, flush immediately with water for a minimum of 15 minutes and get prompt medical attention. If acid is swallowed, call a physician immediately.

 Battery posts, terminals and related accessories contain lead and lead compounds. **Wash hands after handling.**

For information on transmission operation after the battery has been disconnected, refer to *Shift strategy* in the *Driving* chapter.

Because your vehicle's engine is electronically controlled by a computer, some control conditions are maintained by power from the battery. When the battery is disconnected or a new battery is installed, the engine must relearn its idle and fuel trim strategy for optimum driveability and performance. To begin this process:

1. With the vehicle at a complete stop, set the parking brake.
2. Put the gearshift in P (Park), turn off all accessories and start the engine.
3. Run the engine until it reaches normal operating temperature.
4. Allow the engine to idle for at least one minute.
5. Turn the A/C on and allow the engine to idle for at least one minute.
6. Release the parking brake. With your foot on the brake pedal and with the A/C on, put the vehicle in D (Drive) and allow the engine to idle for at least one minute.

## Maintenance and Specifications

7. Drive the vehicle to complete the relearning process.
  - The vehicle may need to be driven 16 km (10 miles) or more to relearn the idle and fuel trim strategy.
  - **If you do not allow the engine to relearn its idle trim, the idle quality of your vehicle may be adversely affected until the idle trim is eventually relearned.**

If the battery has been disconnected or a new battery has been installed, the clock and radio settings must be reset once the battery is reconnected.

- Always dispose of automotive batteries in a responsible manner. Follow your local authorized standards for disposal. Call your local authorized recycling center to find out more about recycling automotive batteries.

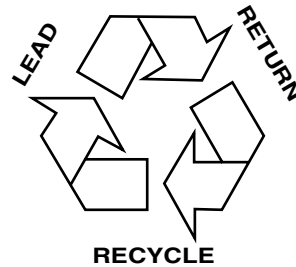

### ENGINE COOLANT

#### Checking engine coolant

The concentration and level of engine coolant should be checked at the mileage intervals listed in the *Scheduled Maintenance Guide*. The coolant concentration should be maintained at 50/50 coolant and distilled water, which equates to a freeze point of  $-36^{\circ}\text{C}$  ( $-34^{\circ}\text{F}$ ). Coolant concentration testing is possible with a hydrometer or antifreeze tester (such as the Rotunda Battery and Antifreeze Tester, 014-R1060). The level of coolant should be maintained at the "FULL COLD" or within the "COLD FILL RANGE" level in the coolant reservoir. If the level falls below, add coolant per the instructions in the *Adding engine coolant* section.

Your vehicle was factory-filled with a 50/50 engine coolant and water concentration. If the concentration of coolant falls below 40% or above 60%, the engine parts could become damaged or not work properly. **A 50–50 mixture of coolant and water provides the following:**

- **Freeze protection down to  $-36^{\circ}\text{C}$  ( $-34^{\circ}\text{F}$ ).**
- **Boiling protection up to  $129^{\circ}\text{C}$  ( $265^{\circ}\text{F}$ ).**
- **Protection against rust and other forms of corrosion.**

326

## Maintenance and Specifications

- **Enables calibrated gauges to work properly.**

When the engine is cold, check the level of the engine coolant in the reservoir.

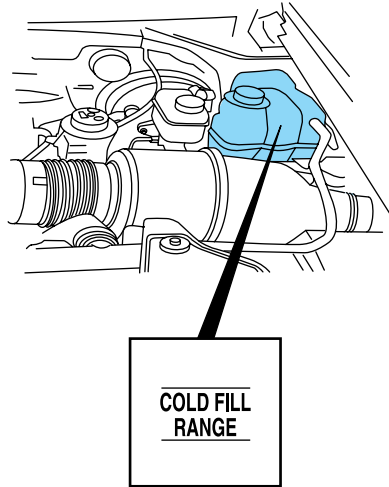

- The engine coolant should be at the “FULL COLD” level or within the “COLD FILL RANGE” as listed on the engine coolant reservoir (depending upon application).
- Refer to the *Scheduled Maintenance Guide* for service interval schedules.
- Be sure to read and understand *Precautions when servicing your vehicle* in this chapter.

If the engine coolant has not been checked at the recommended interval, the engine coolant reservoir may become low or empty. If the reservoir is low or empty, add engine coolant to the reservoir. Refer to *Adding engine coolant* in this chapter.

**Note:** Automotive fluids are not interchangeable; do not use engine coolant, antifreeze or windshield washer fluid outside of its specified function and vehicle location.

### Adding engine coolant

When adding coolant, make sure it is a 50/50 mixture of engine coolant and distilled water. Add the mixture to the coolant reservoir, **when the engine is cool**, until the appropriate fill level is obtained.

## Maintenance and Specifications



Do not add engine coolant when the engine is hot. Steam and scalding liquids released from a hot cooling system can burn you badly. Also, you can be burned if you spill coolant on hot engine parts.



Do not put engine coolant in the windshield washer fluid container. If sprayed on the windshield, engine coolant could make it difficult to see through the windshield.

- **Add Motorcraft Premium Gold Engine Coolant (yellow-colored), VC-7-A (U.S., except CA and OR), VC-7-B (CA and OR only), meeting Ford Specification WSS-M97B51-A1.**

**Note:** Use of Motorcraft Cooling System Stop Leak Pellets, VC-6, may darken the color of Motorcraft Premium Gold Engine Coolant from yellow to golden tan.

- **Do not add/mix an orange-colored, extended life coolant such as Motorcraft Speciality Orange Engine Coolant, VC-2 (US) or CXC-209 (Canada), meeting Ford specification WSS-M97B44-D with the factory-filled coolant.** Mixing Motorcraft Speciality Orange Engine Coolant or any orange-colored extended life product with your factory filled coolant can result in degraded corrosion protection.
- A large amount of water without engine coolant may be added, in case of emergency, to reach a vehicle service location. In this instance, the cooling system must be drained and refilled with a 50/50 mixture of engine coolant and distilled water as soon as possible. Water alone (without engine coolant) can cause engine damage from corrosion, overheating or freezing.
- **Do not use alcohol, methanol, brine or any engine coolants mixed with alcohol or methanol antifreeze (coolant).** Alcohol and other liquids can cause engine damage from overheating or freezing.
- **Do not add extra inhibitors or additives to the coolant.** These can be harmful and compromise the corrosion protection of the engine coolant.

For vehicles with overflow coolant systems with a non-pressurized cap on the coolant recovery system, add coolant to the coolant recovery reservoir when the engine is cool. Add the proper mixture of coolant and water to the "FULL COLD" level. For all other vehicles, which have a coolant degas system with a pressurized cap, or if it is necessary to



## Maintenance and Specifications

remove the coolant pressure relief cap on the radiator of a vehicle with an overflow system, follow these steps to add engine coolant.



To reduce the risk of personal injury, make sure the engine is cool before unscrewing the coolant pressure relief cap. The cooling system is under pressure; steam and hot liquid can come out forcefully when the cap is loosened slightly.

1. Before you begin, turn the engine off and let it cool.
2. When the engine is cool, wrap a thick cloth around the coolant pressure relief cap on the coolant reservoir (a translucent plastic bottle). Slowly turn cap counterclockwise (left) until pressure begins to release.
3. Step back while the pressure releases.
4. When you are sure that all the pressure has been released, use the cloth to turn it counterclockwise and remove the cap.
5. Fill the coolant reservoir slowly with the proper coolant mixture (see above), to within the “COLD FILL RANGE” or the “FULL COLD” level on the reservoir. If you removed the radiator cap in an overflow system, fill the radiator until the coolant is visible and radiator is almost full.
6. Replace the cap. Turn until tightly installed. (Cap must be tightly installed to prevent coolant loss.)

After any coolant has been added, check the coolant concentration, refer to *Checking engine coolant*. If the concentration is not 50/50 (protection to  $-34^{\circ}\text{F}/-36^{\circ}\text{C}$ ), drain some coolant and adjust the concentration. It may take several drains and additions to obtain a 50/50 coolant concentration.

Whenever coolant has been added, the coolant level in the coolant reservoir should be checked the next few times you drive the vehicle. If necessary, add enough 50/50 concentration of engine coolant and distilled water to bring the liquid level to the proper level.

If you have to add more than 1.0 liter (1.0 quart) of engine coolant per month, have your dealer check the engine cooling system. Your cooling system may have a leak. Operating an engine with a low level of coolant can result in engine overheating and possible engine damage.

### Recycled engine coolant

Ford Motor Company does NOT recommend the use of recycled engine coolant in vehicles originally equipped with Motorcraft Premium Gold Engine Coolant since a Ford-approved recycling process is not yet available.

## Maintenance and Specifications



Used engine coolant should be disposed of in an appropriate manner. Follow your community's regulations and standards for recycling and disposing of automotive fluids.

### Coolant refill capacity

To find out how much fluid your vehicle's cooling system can hold, refer to *Refill capacities* in this section.

Fill your engine coolant reservoir as outlined in *Adding engine coolant* in this section.

### Severe climates

If you drive in extremely cold climates (less than  $-36^{\circ}\text{C}$  [ $-34^{\circ}\text{F}$ ):

- **It may be necessary to increase the coolant concentration above 50%.**
- **NEVER increase the coolant concentration above 60%.**
- **Increased engine coolant concentrations above 60% will decrease the overheat protection characteristics of the engine coolant and may cause engine damage.**
- **Refer to the chart on the coolant container to ensure the coolant concentration in your vehicle will provide adequate freeze protection at the temperatures in which you drive in the winter months.**

If you drive in extremely hot climates:

- **It is still necessary to maintain the coolant concentration above 40%.**
- **NEVER decrease the coolant concentration below 40%.**
- **Decreased engine coolant concentrations below 40% will decrease the corrosion protection characteristics of the engine coolant and may cause engine damage.**
- **Decreased engine coolant concentrations below 40% will decrease the freeze protection characteristics of the engine coolant and may cause engine damage.**
- **Refer to the chart on the coolant container to ensure the coolant concentration in your vehicle will provide adequate protection at the temperatures in which you drive.**

Vehicles driven year-round in non-extreme climates should use a 50/50 mixture of engine coolant and distilled water for optimum cooling system and engine protection.



## Maintenance and Specifications

4. Check the coolant level and replenish if low.



Never remove the coolant reservoir cap while the engine is running or hot.

5. Restart the engine and take your vehicle to a service facility.

**Driving the vehicle without repairing the engine problem increases the chance of engine damage. Take your vehicle to a service facility as soon as possible.**

### WHAT YOU SHOULD KNOW ABOUT AUTOMOTIVE FUELS

#### Important safety precautions



Do not overfill the fuel tank. The pressure in an overfilled tank may cause leakage and lead to fuel spray and fire.



The fuel system may be under pressure. If the fuel filler cap is venting vapor or if you hear a hissing sound, wait until it stops before completely removing the fuel filler cap. Otherwise, fuel may spray out and injure you or others.



If you do not use the proper fuel filler cap, excessive pressure or vacuum in the fuel tank may damage the fuel system or cause the fuel cap to disengage in a collision, which may result in possible personal injury.



Automotive fuels can cause serious injury or death if misused or mishandled.



Gasoline may contain benzene, which is a cancer-causing agent.

## Maintenance and Specifications

Observe the following guidelines when handling automotive fuel:

- Extinguish all smoking materials and any open flames before fueling your vehicle.
- Always turn off the vehicle before fueling.
- Automotive fuels can be harmful or fatal if swallowed. Fuel such as gasoline is highly toxic and if swallowed can cause death or permanent injury. If fuel is swallowed, call a physician immediately, even if no symptoms are immediately apparent. The toxic effects of fuel may not be visible for hours.
- Avoid inhaling fuel vapors. Inhaling too much fuel vapor of any kind can lead to eye and respiratory tract irritation. In severe cases, excessive or prolonged breathing of fuel vapor can cause serious illness and permanent injury.
- Avoid getting fuel liquid in your eyes. If fuel is splashed in the eyes, remove contact lenses (if worn), flush with water for 15 minutes and seek medical attention. Failure to seek proper medical attention could lead to permanent injury.
- Fuels can also be harmful if absorbed through the skin. If fuel is splashed on the skin and/or clothing, promptly remove contaminated clothing and wash skin thoroughly with soap and water. Repeated or prolonged skin contact with fuel liquid or vapor causes skin irritation.
- Be particularly careful if you are taking “Antabuse” or other forms of disulfiram for the treatment of alcoholism. Breathing gasoline vapors, or skin contact could cause an adverse reaction. In sensitive individuals, serious personal injury or sickness may result. If fuel is splashed on the skin, promptly wash skin thoroughly with soap and water. Consult a physician immediately if you experience an adverse reaction.



 When refueling always shut the engine off and never allow sparks or open flames near the filler neck. Never smoke while refueling. Fuel vapor is extremely hazardous under certain conditions. Care should be taken to avoid inhaling excess fumes.

 The flow of fuel through a fuel pump nozzle can produce static electricity, which can cause a fire if fuel is pumped into an ungrounded fuel container.

## Maintenance and Specifications

Use the following guidelines to avoid static build-up when filling an ungrounded fuel container:

- Place approved fuel container on the ground.
- DO NOT fill a fuel container while it is in the vehicle (including the cargo area).
- Keep the fuel pump nozzle in contact with the fuel container while filling.
- DO NOT use a device that would hold the fuel pump handle in the fill position.

### Fuel Filler Cap

Your fuel tank filler cap has an indexed design with a 1/8 turn on/off feature.

When fueling your vehicle:

1. Turn the engine off.
2. Carefully turn the filler cap counterclockwise 1/8 of a turn until it stops.
3. Pull to remove the cap from the fuel filler pipe.
4. To install the cap, align the tabs on the cap with the notches on the filler pipe.
5. Turn the filler cap clockwise 1/8 of a turn until it stops.

“CHECK/TIGHTEN FUEL CAP” will display in the message center when the fuel filler cap is not properly installed. Proper fuel filler cap installation is checked automatically as the vehicle is driven, but not until after some fuel is used (fuel gauge drops below full). Once the fuel filler cap is properly secured, “CHECK/TIGHTEN FUEL CAP” will turn off after a short period of driving.

**If you must replace the fuel filler cap, replace it with a fuel filler cap that is designed for your vehicle. The customer warranty may be void for any damage to the fuel tank or fuel system if the correct genuine Ford or Motorcraft fuel filler cap is not used.**



The fuel system may be under pressure. If the fuel filler cap is venting vapor or if you hear a hissing sound, wait until it stops before completely removing the fuel filler cap. Otherwise, fuel may spray out and injure you or others.



If you do not use the proper fuel filler cap, excessive pressure or vacuum in the fuel tank may damage the fuel system or cause the fuel cap to disengage in a collision, which may result in possible personal injury.

## Maintenance and Specifications

### Choosing the right fuel

Use only UNLEADED FUEL. The use of leaded fuel is prohibited by law and could damage your vehicle.

Your vehicle was not designed to use fuel or fuel additives with metallic compounds, including manganese-based additives. Studies indicate that these additives can cause your vehicle's emission control system to deteriorate more rapidly. In Canada, many fuels contain metallic additives, but fuels free of such additives may be available; check with your local fuel dealer.

Do not use fuel containing methanol. It can damage critical fuel system components.

Repairs to correct the effects of using a fuel for which your vehicle was not designed may not be covered by your warranty.

### Octane recommendations

Your vehicle is designed to use "Premium" unleaded gasoline with an (R+M)/2 octane rating of 91 or higher for optimum performance.

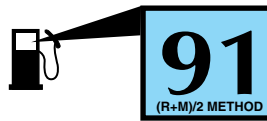

The use of gasolines with lower octane ratings may degrade performance. The use of gasolines labeled as "Premium" in high altitude areas that are sold with octane ratings of less than 91 is not recommended.

Do not be concerned if your engine sometimes knocks lightly. However, if it knocks heavily under most driving conditions while you are using fuel with the recommended octane rating, see your dealer or a qualified service technician to prevent any engine damage.

### Fuel quality

If you are experiencing starting, rough idle or hesitation driveability problems during a cold start, try a different brand of gasoline. If the problems persist, see your dealer or a qualified service technician.

It should not be necessary to add any aftermarket products to your fuel tank if you continue to use high quality fuel of the recommended octane rating. Aftermarket products could cause damage to the fuel system.

Repairs to correct the effects of using an aftermarket product in your fuel may not be covered by your warranty.

Many of the world's automakers approved the World-wide Fuel Charter that recommends gasoline specifications to provide improved

## Maintenance and Specifications

performance and emission control system protection for your vehicle. Gasolines that meet the World-wide Fuel Charter should be used when available. Ask your fuel supplier about gasolines that meet the World-wide Fuel Charter.

### Cleaner air

Ford endorses the use of reformulated “cleaner-burning” gasolines to improve air quality.

### Running out of fuel

Avoid running out of fuel because this situation may have an adverse affect on powertrain components.

If you have run out of fuel:

- You may need to cycle the ignition from OFF to ON several times after refueling, to allow the fuel system to pump the fuel from the tank to the engine.
- Your *Service engine soon* indicator may come on. For more information on the *Service engine soon* indicator, refer to the *Instrument cluster* chapter.

### Fuel Filter

For fuel filter replacement, see your dealer or a qualified service technician. Refer to the scheduled maintenance guide for the appropriate intervals for changing the fuel filter.

**Replace the fuel filter with an authorized Motorcraft part. The customer warranty may be void for any damage to the fuel system if an authorized Motorcraft fuel filter is not used.**

## ESSENTIALS OF GOOD FUEL ECONOMY

### Measuring techniques

Your best source of information about actual fuel economy is you, the driver. You must gather information as accurately and consistently as possible. Fuel expense, frequency of fill-ups or fuel gauge readings are NOT accurate as a measure of fuel economy. We do not recommend taking fuel economy measurements during the first 1,600 km (1,000 miles) of driving (engine break-in period). You will get a more accurate measurement after 3,000 km–5,000 km (2,000 miles–3,000 miles).

### Filling the tank

The advertised fuel capacity of the fuel tank on your vehicle is equal to the rated refill capacity of the fuel tank as listed in the *Refill capacities* section of this chapter.



## Maintenance and Specifications

The advertised capacity is the amount of the indicated capacity and the empty reserve combined. Indicated capacity is the difference in the amount of fuel in a full tank and a tank when the fuel gauge indicates empty. Empty reserve is the small amount of fuel remaining in the fuel tank after the fuel gauge indicates empty.

**The amount of usable fuel in the empty reserve varies and should not be relied upon to increase driving range. When refueling your vehicle after the fuel gauge indicates empty, you might not be able to refuel the full amount of the advertised capacity of the fuel tank due to the empty reserve still present in the tank.**

For consistent results when filling the fuel tank:

- Turn the engine/ignition switch to the off position prior to refueling, an error in the reading will result if the engine is left running.
- Use the same filling rate setting (low — medium — high) each time the tank is filled.
- Allow no more than 2 automatic click-offs when filling.
- Always use fuel with the recommended octane rating.
- Use a known quality gasoline, preferably a national brand.
- Use the same side of the same pump and have the vehicle facing the same direction each time you fill up.
- Have the vehicle loading and distribution the same every time.

Your results will be most accurate if your filling method is consistent.

### Calculating fuel economy

1. Fill the fuel tank completely and record the initial odometer reading (in kilometers or miles).
2. Each time you fill the tank, record the amount of fuel added (in liters or gallons).
3. After at least three to five tank fill-ups, fill the fuel tank and record the current odometer reading.
4. Subtract your initial odometer reading from the current odometer reading.
5. Follow one of the simple calculations in order to determine fuel economy:

Calculation 1: **Multiply liters used by 100, then divide by total kilometers traveled.**

Calculation 2: **Divide total miles traveled by total gallons used.**

## Maintenance and Specifications

Keep a record for at least one month and record the type of driving (city or highway). This will provide an accurate estimate of the vehicle's fuel economy under current driving conditions. Additionally, keeping records during summer and winter will show how temperature impacts fuel economy. In general, lower temperatures give lower fuel economy.

### Driving style — good driving and fuel economy habits

Give consideration to the lists that follow and you may be able to change a number of variables and improve your fuel economy.

#### **Habits**

- Smooth, moderate operation can yield up to 10% savings in fuel.
- Steady speeds without stopping will usually give the best fuel economy.
- Idling for long periods of time (greater than one minute) may waste fuel.
- Anticipate stopping; slowing down may eliminate the need to stop.
- Sudden or hard accelerations may reduce fuel economy.
- Slow down gradually.
- Driving at reasonable speeds (traveling at 88 km/h [55 mph] uses 15% less fuel than traveling at 105 km/h [65 mph]).
- Revving the engine before turning it off may reduce fuel economy.
- Using the air conditioner or defroster may reduce fuel economy.
- You may want to turn off the speed control in hilly terrain if unnecessary shifting between third and fourth gear occurs. Unnecessary shifting of this type could result in reduced fuel economy.
- Warming up a vehicle on cold mornings is not required and may reduce fuel economy.
- Resting your foot on the brake pedal while driving may reduce fuel economy.
- Combine errands and minimize stop-and-go driving.

#### **Maintenance**

- Keep tires properly inflated and use only recommended size.
- Operating a vehicle with the wheels out of alignment will reduce fuel economy.
- Use recommended engine oil. Refer to *Lubricant specifications* in this chapter.

## Maintenance and Specifications

- Perform all regularly scheduled maintenance items. Follow the recommended maintenance schedule and owner maintenance checks found in your vehicle scheduled maintenance guide.

### **Conditions**

- Heavily loading a vehicle or towing a trailer may reduce fuel economy at any speed.
- Carrying unnecessary weight may reduce fuel economy (as much as 0.4 km/L [1 mpg] is lost for every 180 kg [400 lb] of weight carried).
- Adding certain accessories to your vehicle (for example bug deflectors, rollbars/light bars, running boards, ski/luggage racks) may reduce fuel economy.
- Using fuel blended with alcohol may lower fuel economy.
- Fuel economy may decrease with lower temperatures during the first 12–16 km (8–10 miles) of driving.
- Driving on flat terrain offers improved fuel economy as compared to driving on hilly terrain.
- Transmissions give their best fuel economy when operated in the top cruise gear and with steady pressure on the gas pedal.
- Four-wheel-drive operation (if equipped) is less fuel efficient than two-wheel-drive operation.
- Close windows for high speed driving.

### **EPA window sticker**

The characteristics of the four wheel drive vehicle, like those of many, similar competitive products, fit within categories where the fuel economy labeling regulations do not apply. Therefore, the following information applies only to the two wheel drive vehicle.

Every new vehicle should have the EPA window sticker. Contact your dealer if the window sticker is not supplied with your vehicle. The EPA window sticker should be your guide for the fuel economy comparisons with other vehicles.

It is important to note the box in the lower left corner of the window sticker. These numbers represent the range of fuel economy expected on the vehicle under optimum conditions. Your fuel economy may vary depending upon the method of operation and conditions.

### **EMISSION CONTROL SYSTEM**

Your vehicle is equipped with various emission control components and a catalytic converter which will enable your vehicle to comply with

## Maintenance and Specifications

applicable exhaust emission standards. To make sure that the catalytic converter and other emission control components continue to work properly:

- Use only the specified fuel listed.
- Avoid running out of fuel.
- Do not turn off the ignition while your vehicle is moving, especially at high speeds.
- Have the items listed in your *Scheduled Maintenance Guide* performed according to the specified schedule.

The scheduled maintenance items listed in the *Scheduled Maintenance Guide* are essential to the life and performance of your vehicle and to its emissions system.

If other than Ford, Motorcraft or Ford-authorized parts are used for maintenance replacements or for service of components affecting emission control, such non-Ford parts should be equivalent to genuine Ford Motor Company parts in performance and durability.



Do not park, idle, or drive your vehicle in dry grass or other dry ground cover. The emission system heats up the engine compartment and exhaust system, which can start a fire.

Illumination of the “Check Engine” light, charging system warning light or the temperature warning light, fluid leaks, strange odors, smoke or loss of engine power, could indicate that the emission control system is not working properly.



Exhaust leaks may result in entry of harmful and potentially lethal fumes into the passenger compartment.

Do not make any unauthorized changes to your vehicle or engine. By law, vehicle owners and anyone who manufactures, repairs, services, sells, leases, trades vehicles, or supervises a fleet of vehicles are not permitted to intentionally remove an emission control device or prevent it from working. Information about your vehicle’s emission system is on the Vehicle Emission Control Information Decal located on or near the engine. This decal identifies engine displacement and gives some tune up specifications.

Please consult your *Warranty Guide* for complete emission warranty information.

## Maintenance and Specifications

### On board diagnostics (OBD-II)

Your vehicle is equipped with a computer that monitors the engine's emission control system. This system is commonly known as the On Board Diagnostics System (OBD-II). This OBD-II system protects the environment by ensuring that your vehicle continues to meet government emission standards. The OBD-II system also assists the service technician in properly servicing your vehicle. When the *Check engine/Service engine soon* light illuminates, the OBD-II system has detected a malfunction. Temporary malfunctions may cause your *Check engine/Service engine soon* light to illuminate. Examples are:

1. The vehicle has run out of fuel. (The engine may misfire or run poorly.)
2. Poor fuel quality or water in the fuel.
3. The fuel cap may not have been securely tightened.

These temporary malfunctions can be corrected by filling the fuel tank with good quality fuel and/or properly tightening the fuel cap. After three driving cycles without these or any other temporary malfunctions present, the *Check engine/Service engine soon* light should turn off. (A driving cycle consists of a cold engine startup followed by mixed city/highway driving.) No additional vehicle service is required.

If the *Check engine/Service engine soon* light remains on, have your vehicle serviced at the first available opportunity.

### Readiness for Inspection/Maintenance (I/M) testing

In some localities, it may be a legal requirement to pass an I/M test of the on-board diagnostics system. If your *Check engine/Service engine soon* light is on, refer to the description in the *Warning lights and chimes* section of the *Instrument Cluster* chapter. Your vehicle may not pass the I/M test with the *Check engine/Service engine soon* light on.

If the vehicle's powertrain system or its battery has just been serviced, the on-board diagnostics system is reset to a "not ready for I/M test" condition. To ready the on-board diagnostics system for I/M testing, a minimum of 30 minutes of city and highway driving is necessary as described below:

- First, at least 10 minutes of driving on an expressway or highway.
- Next, at least 20 minutes driving in stop-and-go, city-type traffic with at least four idle periods.

Allow the vehicle to sit for at least eight hours without starting the engine. Then, start the engine and complete the above driving cycle. The

## Maintenance and Specifications

engine must warm up to its normal operating temperature. Once started, do not turn off the engine until the above driving cycle is complete.

### CHECKING AND ADDING POWER STEERING FLUID

Check the power steering fluid. Refer to the scheduled maintenance guide for the service interval schedules. If adding fluid is necessary, use only Ford Premium Power Steering Fluid or MERCON® ATF.

1. Start the engine and let it run until it reaches normal operating temperature (the engine coolant temperature gauge indicator will be near the center of the normal area between H and C).

2. While the engine idles, turn the steering wheel left and right several times.

3. Turn the engine off.

4. Check the fluid level in the reservoir. It should be between the MIN and MAX lines. Do not add fluid if the level is in this range.

5. If the fluid is low, add fluid in small amounts, continuously checking the level until it reaches the range between the MIN and MAX lines. Be sure to put the cap back on the reservoir.

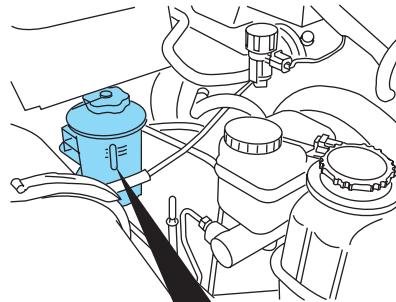
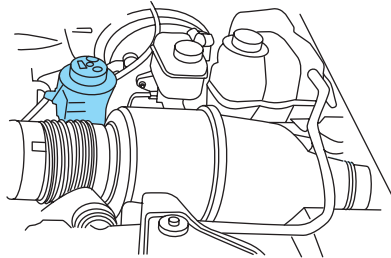

## Maintenance and Specifications

### BRAKE FLUID RESERVOIR

The fluid level will drop slowly as the brakes wear, and will rise when the brake components are replaced. Fluid levels between the “MIN” and “MAX” lines are within the normal operating range, there is no need to add fluid. If the fluid levels are outside of the normal operating range, the performance of your brake system could be compromised, seek service from your dealer immediately.

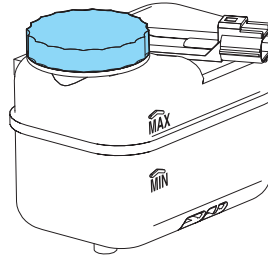

### TRANSMISSION FLUID

#### Checking automatic transmission fluid

Refer to your *Scheduled Maintenance Guide* for scheduled intervals for fluid checks and changes. Your transmission does not consume fluid. However, the fluid level should be checked if the transmission is not working properly, i.e., if the transmission slips or shifts slowly or if you notice some sign of fluid leakage.

Automatic transmission fluid expands when warmed. To obtain an accurate fluid check, drive the vehicle until it is at normal operating temperature (approximately 30 km [20 miles]). If your vehicle has been operated for an extended period at high speeds, in city traffic during hot weather or pulling a trailer, the vehicle should be turned off for about 30 minutes to allow fluid to cool before checking.

1. Drive the vehicle 30 km (20 miles) or until it reaches normal operating temperature.
2. Park the vehicle on a level surface and engage the parking brake.
3. With the parking brake engaged and your foot on the brake pedal, start the engine and move the gearshift lever through all of the gear ranges. Allow sufficient time for each gear to engage.
4. Latch the gearshift lever in P (Park) and leave the engine running.
5. Remove the dipstick, wiping it clean with a clean, dry lint free rag. If necessary, refer to *Identifying components in the engine compartment* in this chapter for the location of the dipstick.
6. Install the dipstick making sure it is fully seated in the filler tube.

## Maintenance and Specifications

7. Remove the dipstick and inspect the fluid level. The fluid should be in the designated area for normal operating temperature or ambient temperature.

### Low fluid level

Do not drive the vehicle if the fluid level is at the bottom of the dipstick and the ambient temperature is above 10°C (50°F).



### Correct fluid level

The transmission fluid should be checked at normal operating temperature 66°C-77°C (150°F-170°F) on a level surface. The normal operating temperature can be reached after approximately 30 km (20 miles) of driving.

You can check the fluid without driving if the ambient temperature is above 10°C (50°F). However, if fluid is added at this time, an overfill condition could result when the vehicle reaches normal operating temperature.

The transmission fluid should be in this range if at normal operating temperature (66°C-77°C [150°F-170°F]).

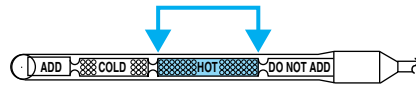

The transmission fluid should be in this range if at ambient temperature (10°C-35°C [50°F-95°F]).



### High fluid level

Fluid levels above the safe range may result in transmission failure. An overfill condition of transmission fluid may cause shift and/or engagement concerns and/or possible damage.

High fluid levels can be caused by an overheating condition.



### Adjusting automatic transmission fluid levels

Before adding any fluid, make sure the correct type is used. The type of fluid used is normally indicated on the dipstick and also in the *Lubricant specifications* section in this chapter.

**Use of a non-approved automatic transmission fluid may cause internal transmission component damage.**



## Maintenance and Specifications

If necessary, add fluid in 250 mL (1/2 pint) increments through the filler tube until the level is correct.

If an overfill occurs, excess fluid should be removed by a qualified technician.



**An overfill condition of transmission fluid may cause shift and/or engagement concerns and/or possible damage.**

Do not use supplemental transmission fluid additives, treatments or cleaning agents. The use of these materials may affect transmission operation and result in damage to internal transmission components.

### DRIVELINE UNIVERSAL JOINT AND SLIP YOKE

Your vehicle may be equipped with universal joints that require lubrication. Refer to the *Scheduled Maintenance Guide* for maintenance intervals. If the original universal joints are replaced with universal joints equipped with grease fittings, lubrication will also be necessary.

### AIR FILTER MAINTENANCE

Refer to the scheduled maintenance guide for the appropriate intervals for changing the air filter element.

When changing the air filter element, use only the Motorcraft air filter element listed. Refer to *Motorcraft part numbers* in this chapter.

**Note:** Do not start your engine with the air cleaner removed and do not remove it while the engine is running.

#### Changing the air filter element

1. Loosen the clamp that secures the air inlet tube to the engine air filter cover and disconnect the tube from the cover.

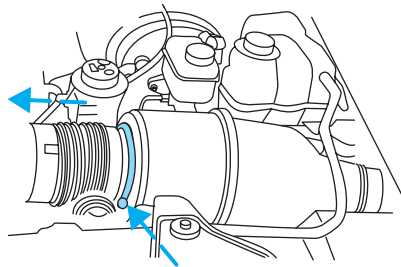

## Maintenance and Specifications

2. Loosen the clamp that secures the air filter cover to the air filter housing and carefully separate the cover from housing.

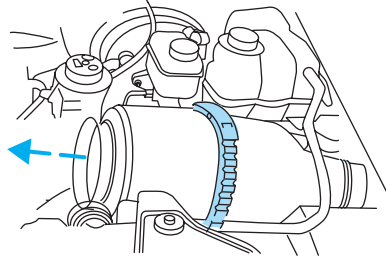

3. Remove the air filter element from the air filter housing.

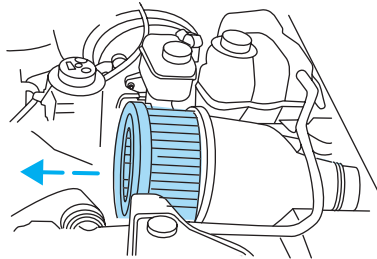

4. Install a new air filter element. Be careful not to crimp the filter element edges between the air filter housing and cover. This could cause filter damage and allow unmetered air to enter the engine if not properly seated.

5. Replace the air filter cover and secure the clamp.

6. Replace the air inlet tube and secure the clamp.

### INFORMATION ABOUT UNIFORM TIRE QUALITY GRADING

New vehicles are fitted with tires that have a rating on them called Tire Quality Grades. The Quality grades can be found where applicable on the tire sidewall between tread shoulder and maximum section width. For example:

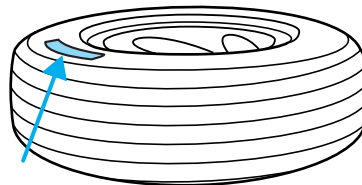

- **Treadwear 200 Traction AA Temperature A**

These Tire Quality Grades are determined by standards that the United States Department of Transportation has set.

## Maintenance and Specifications

Tire Quality Grades apply to new pneumatic tires for use on passenger cars. They do not apply to deep tread, winter-type snow tires, space-saver or temporary use spare tires, tires with nominal rim diameters of 10 to 12 inches or limited production tires as defined in Title 49 Code of Federal Regulations Part 575.104(c)(2).

**U.S. Department of Transportation-Tire quality grades:** The U.S. Department of Transportation requires Ford to give you the following information about tire grades exactly as the government has written it.

### Treadwear

The treadwear grade is a comparative rating based on the wear rate of the tire when tested under controlled conditions on a specified government test course. For example, a tire graded 150 would wear one and one-half (1 1/2) times as well on the government course as a tire graded 100. The relative performance of tires depends upon the actual conditions of their use, however, and may depart significantly from the norm due to variations in driving habits, service practices, and differences in road characteristics and climate.

### Traction AA A B C

The traction grades, from highest to lowest are AA, A, B, and C. The grades represent the tire's ability to stop on wet pavement as measured under controlled conditions on specified government test surfaces of asphalt and concrete. A tire marked C may have poor traction performance.



The traction grade assigned to this tire is based on straight-ahead braking traction tests, and does not include acceleration, cornering, hydroplaning or peak traction characteristics.

### Temperature A B C

The temperature grades are A (the highest), B and C, representing the tire's resistance to the generation of heat and its ability to dissipate heat when tested under controlled conditions on a specified indoor laboratory test wheel. Sustained high temperature can cause the material of the tire to degenerate and reduce tire life, and excessive temperature can lead to sudden tire failure. The grade C corresponds to a level of performance which all passenger car tires must meet under the Federal Motor Vehicle Safety Standard No. 109. Grades B and A represent higher levels of performance on the laboratory test wheel than the minimum required by law.

## Maintenance and Specifications



The temperature grade for this tire is established for a tire that is properly inflated and not overloaded. Excessive speed, underinflation, or excessive loading, either separately or in combination, can cause heat buildup and possible tire failure.

### TIRES

Tires are designed to give many thousands of miles of service, but they must be maintained in order to get the maximum benefit from them.

#### Glossary of tire terminology

- **Tire label:** A label showing the OE (Original Equipment) tire sizes, recommended inflation pressure and the maximum weight the vehicle can carry.
- **Tire Identification Number (TIN):** A number on the sidewall of each tire providing information about the tire brand and manufacturing plant, tire size and date of manufacturer.
- **Inflation pressure:** A measure of the amount of air in a tire.
- **Standard load:** A class of P-metric or Metric tires designed to carry a maximum load at 35 psi [37 psi (2.5 bar) for Metric tires]. Increasing the inflation pressure beyond this pressure will not increase the tires load carrying capability.
- **Extra load:** A class of P-metric or Metric tires designed to carry a heavier maximum load at 41 psi [43 psi (2.9 bar) for Metric tires]. Increasing the inflation pressure beyond this pressure will not increase the tires load carrying capability.
- **kPa:** Kilopascal, a metric unit of air pressure.
- **PSI:** Pounds per square inch, a standard unit of air pressure.
- **B-pillar:** The structural member at the side of the vehicle behind the front door.
- **Bead area of the tire:** Area of the tire next to the rim.
- **Sidewall of the tire:** Area between the bead area and the tread.
- **Tread area of the tire:** Area of the perimeter of the tire that contacts the road when mounted on the vehicle.
- **Rim:** The metal support (wheel) for a tire or a tire and tube assembly upon which the tire beads are seated.

## Maintenance and Specifications

### INFORMATION CONTAINED ON THE TIRE SIDEWALL

Federal law requires tire manufacturers to place standardized information on the sidewall of all tires. This information identifies and describes the fundamental characteristics of the tire and also provides a U.S. DOT Tire Identification Number for safety standard certification and in case of a recall.

#### Information on “P” type tires

P215/65R15 95H is an example of a tire size, load index and speed rating. The definitions of these items are listed below. (Note that the tire size, load index and speed rating for your vehicle may be different than this example.)

1. **P:** Indicates a tire, designated by the Tire and Rim Association (T&RA), that may be used for service on cars, SUVs, minivans and light trucks.

**Note:** If your tire size does not begin with a letter this may mean it is designated by either ETRTO (European Tire and Rim Technical Organization) or JATMA (Japan Tire Manufacturing Association).

2. **215:** Indicates the nominal width of the tire in millimeters from sidewall edge to sidewall edge. In general, the larger the number, the wider the tire.

3. **65:** Indicates the aspect ratio which gives the tire's ratio of height to width.

4. **R:** Indicates a “radial” type tire.

5. **15:** Indicates the wheel or rim diameter in inches. If you change your wheel size, you will have to purchase new tires to match the new wheel diameter.

6. **95:** Indicates the tire's load index. It is an index that relates to how much weight a tire can carry. You may find this information in your owner's guide. If not, contact a local tire dealer.

**Note:** You may not find this information on all tires because it is not required by federal law.

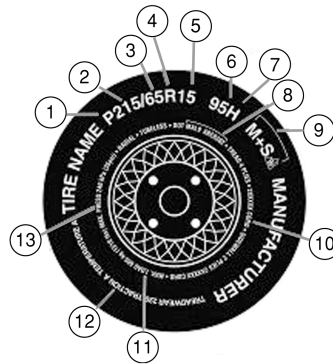

## Maintenance and Specifications

7. **H:** Indicates the tire's speed rating. The speed rating denotes the speed at which a tire is designed to be driven for extended periods of time under a standard condition of load and inflation pressure. The tires on your vehicle may operate at different conditions for load and inflation pressure. These speed ratings may need to be adjusted for the difference in conditions. The ratings range from 99 mph (159 km/h) to 186 mph (299 km/h). These ratings are listed in the following chart.

**Note:** You may not find this information on all tires because it is not required by federal law.

Letter rating	Speed rating - mph (km/h)
Q	99 mph (159 km/h)
R	106 mph (171 km/h)
S	112 mph (180 km/h)
T	118 mph (190 km/h)
U	124 mph (200 km/h)
H	130 mph (210 km/h)
V	149 mph (240 km/h)
W	168 mph (270 km/h)
Y	186 mph (299 km/h)

**Note:** For tires with a maximum speed capability over 149 mph (240 km/h), tire manufacturers sometimes use the letters ZR. For those with a maximum speed capability over 186 mph (299 km/h), tire manufacturers always use the letters ZR.

8. **U.S. DOT Tire Identification Number (TIN):** This begins with the letters "DOT" and indicates that the tire meets all federal standards. The next two numbers or letters are the plant code where it was manufactured, the next two are the tire size code and the last four numbers represent the week and year the tire was built. For example, the numbers 317 mean the 31st week of 1997. After 2000 the numbers go to four digits. For example, 2501 means the 25th week of 2001. The numbers in between are identification codes used for traceability. This information is used to contact customers if a tire defect requires a recall.

9. **M+S or M/S:** Mud and Snow. or

**AT:** All Terrain. or

**AS:** All Season.

10. **Tire Ply Composition and Material Used:** Indicates the number of plies or the number of layers of rubber-coated fabric in the tire tread and

## Maintenance and Specifications

sidewall. Tire manufacturers also must indicate the ply materials in the tire and the sidewall, which include steel, nylon, polyester, and others.

11. **Maximum Load:** Indicates the maximum load in kilograms and pounds that can be carried by the tire. Refer to the tire label or the safety certification label, located on the B-Pillar or the driver's door, for the correct tire pressure for your vehicle

### 12. Treadwear, Traction and Temperature Grades

- **Treadwear:** The treadwear grade is a comparative rating based on the wear rate of the tire when tested under controlled conditions on a specified government test course. For example, a tire graded 150 would wear one and one-half (1½) times as well on the government course as a tire graded 100.
- **Traction:** The traction grades, from highest to lowest are AA, A, B, and C. The grades represent the tire's ability to stop on wet pavement as measured under controlled conditions on specified government test surfaces of asphalt and concrete. A tire marked C may have poor traction performance.
- **Temperature:** The temperature grades are A (the highest), B and C, representing the tire's resistance to the generation of heat and its ability to dissipate heat when tested under controlled conditions on a specified indoor laboratory test wheel.

13. **Maximum Permissible Inflation Pressure:** Tire manufactures maximum permissible pressure and/or the pressure at which the maximum load can be carried by the tire. This pressure is normally higher than the manufacturer's recommended cold inflation pressure which can be found on either the tire label or certification label which is located on the structure by the trailing edge of the driver's door or the edge of the driver's door. The cold inflation pressure should never be set lower than the recommended pressure on the vehicle label.

The tire suppliers may have additional markings, notes or warnings such as standard load, radial tubeless, etc.

## Maintenance and Specifications

### Additional information contained on the tire sidewall for “LT” type tires

“LT” type tires have some additional information than those of “P” type tires; these differences are described below:

1. **LT:** Indicates a tire, designated by the Tire and Rim Association (T&RA), that is intended for service on light trucks.

#### 2. **Load Range/Load Inflation**

**Limits:** Indicates the tires load-carrying capabilities and its inflation limits.

#### 3. **Maximum Load Dual lbs. (kg)**

**at psi (kPa) cold:** Indicates the maximum load and tire pressure when the tire is used as a dual; a dual is defined as when four tires are put on the rear axle (a total of six or more tires on the vehicle).

**4. Maximum Load Single lbs. (kg) at psi (kPa) cold:** Indicates the maximum load and tire pressure when the tire is used as a single; a single is defined as when two tires (total) are put on the rear axle.

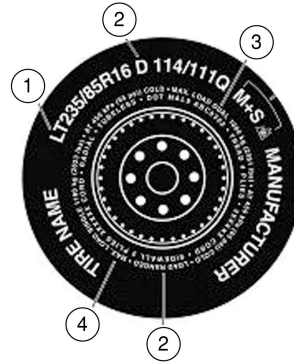



## Maintenance and Specifications

### Information on “T” type tires

T145/80D16 is an example of a tire size.

**Note:** The temporary tire size for your vehicle may be different than this example.

1. **T:** Indicates a type of tire, designated by the Tire and Rim Association (T&RA), that is intended for temporary service on cars, SUVs, minivans and light trucks.

2. **145:** Indicates the nominal width of the tire in millimeters from sidewall edge to sidewall edge. In general, the larger the number, the wider the tire.

3. **80:** Indicates the aspect ratio which gives the tires ratio of height to width. Numbers of 70 or lower indicate a short sidewall.

4. **D:** Indicates a “diagonal” type tire.

**R:** Indicates a “radial” type tire.

5. **16:** Indicates the wheel or rim diameter in inches. If you change your wheel size, you will have to purchase new tires to match the new wheel diameter.

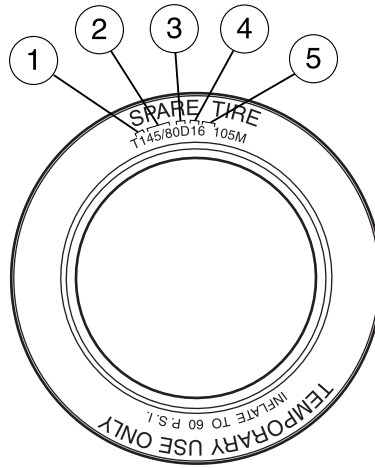

### Location of the tire label

You will find a tire label containing tire inflation pressure by tire size and other important information located on the B-Pillar or the driver's door.

### TIRE CARE

Improper or inadequate vehicle maintenance can also cause tires to wear abnormally. Here are some of the important maintenance items:

### Inflating your tires



When checking the air pressure in your tires, make sure that you carefully attach the air pressure gauge/air hose to the tire's valve stem directly on top of the valve stem. If you bend the valve stem, it may become damaged and cause an air leak.

## Maintenance and Specifications

Use a tire gauge to check the tire inflation pressure, including the spare, at least monthly and before long trips. You are strongly urged to buy a reliable tire pressure gauge, as automatic service station gauges may be inaccurate. Ford recommends the use of a digital or dial type tire pressure gauge rather than a stick type tire pressure gauge.

Use the recommended cold inflation pressure for optimum tire performance and wear. Under-inflation or over-inflation may cause uneven treadwear patterns.



Under-inflation is the most common cause of tire failures and may result in severe tire cracking, tread separation or "blowout", with unexpected loss of vehicle control and increased risk of injury. Under-inflation increases sidewall flexing and rolling resistance, resulting in heat buildup and internal damage to the tire. It also may result in unnecessary tire stress, irregular wear, loss of vehicle control and accidents. A tire can lose up to half of its air pressure and not appear to be flat!

When weather temperature changes occur, tire inflation pressures also change. A 10° F (6° C) temperature change can cause a corresponding drop of 1 psi (7 kPa) in inflation pressure. Check your tire pressures frequently and adjust them to the proper pressure which can be found on the tire label or certification label.

If you are checking tire pressure when the tire is hot, (i.e. driven more than 1 mile [1.6 km]), never "bleed" or reduce air pressure. The tires are hot from driving and it is normal for pressures to increase above recommended cold pressures. A hot tire at or below recommended cold inflation pressure could be significantly under-inflated.

To check the pressure in your tire(s):

1. Make sure the tires are cool, meaning they are not hot from driving even a mile.

**Note:** If you have to drive a distance to get air for your tire(s), check and record the tire pressure first and add the appropriate air pressure when you get to the pump. It is normal for tires to heat up and the air pressure inside to go up as you drive. Never "bleed" or reduce air pressure when tires are hot.

2. Remove the cap from the valve on one tire, then firmly press the tire gauge onto the valve and measure the pressure.

3. Add enough air to reach the recommended air pressure

**Note:** If you overfill the tire, release air by pushing on the metal stem in the center of the valve. Then recheck the pressure with your tire gauge.

## Maintenance and Specifications

4. Replace the valve cap.
  5. Repeat this procedure for each tire, including the spare.
- Note:** Some spare tires require higher inflation pressure than the other tires. Check the tire label on the B pillar or the driver's door for the recommended spare tire pressure.
6. Visually inspect the tires to make sure there are no nails or other objects embedded that could poke a hole in the tire and cause an air leak.
  7. Check the sidewalls to make sure there are no gouges, cuts or bulges.

### Tire and wheel alignment

A bad jolt from hitting a curb or pothole can cause the front end of your vehicle to become misaligned or damage to your tires. If your vehicle seems to pull to one side when you're driving, the wheels may be out of alignment. Have a qualified technician at a Ford or Lincoln/Mercury dealer check the wheel alignment periodically.

Wheel misalignment in the front or the rear can cause uneven and rapid treadwear of your tires and should be corrected by a qualified technician at a Ford or Lincoln/Mercury dealer. Front wheel drive (FWD) vehicles, and those with an independent rear suspension require alignment of all four wheels.

The tires should also be balanced periodically. An unbalanced tire and wheel assembly may result in irregular tire wear.

### Tire rotation

Rotating your tires at the recommended interval (as indicated in the *Scheduled Maintenance Guide* that comes with your vehicle) will help your tires wear more evenly providing better tire performance and longer tire life. Unless otherwise specified, rotate the tires approximately every 5,000 miles (8,000 km).

## Maintenance and Specifications

- Front Wheel Drive (FWD) vehicles (front tires at top of diagram)

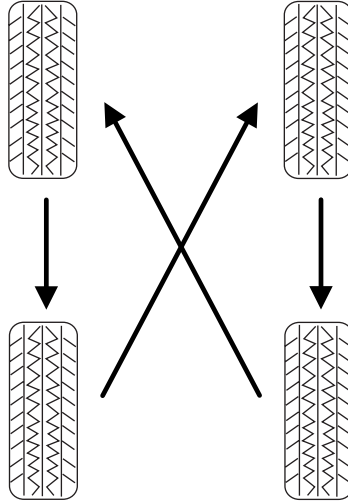

- Rear Wheel Drive (RWD) vehicles/Four Wheel Drive (4WD) vehicles (front tires at top of diagram)

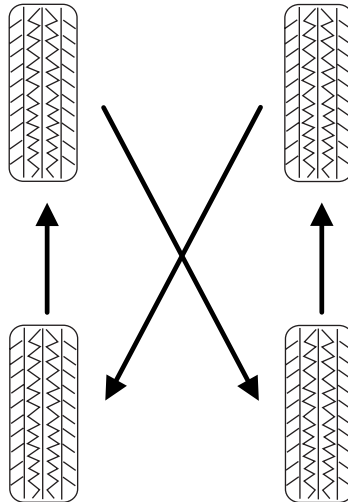

## Maintenance and Specifications

Sometimes irregular tire wear can be corrected by rotating the tires.

**Note:** If your tires show uneven wear ask a qualified technician at a Ford or Lincoln/Mercury dealership to check for and correct any wheel misalignment, tire imbalance or mechanical problem involved before tire rotation.

**Note:** Your vehicle may be equipped with a dissimilar spare tire/wheel. A dissimilar spare tire/wheel is defined as a spare tire and/or wheel that is different in brand, size or appearance from the road tires and wheels. If you have a dissimilar spare tire/wheel it is intended for temporary use only and should not be used in a tire rotation.

**Note:** After having your tires rotated, inflation pressure must be checked and adjusted to the vehicle requirements.

### Tire wear

Measure and inspect the tire tread on all your tires periodically. Advanced and unusual tire wear can reduce the ability of tread to grip the road in adverse (wet, snowy, etc.) conditions. Visually check your tires for uneven wear, looking for high and low areas or unusually smooth areas. Also check for signs of tire damage.

When the tread is worn down to 1/16th of an inch (2 mm), tires must be replaced to prevent your vehicle from skidding and hydroplaning.

Built-in treadwear indicators, or “wear bars”, which look like narrow strips of smooth rubber across the tread will appear on the tire when the tread is worn down to 1/16th of an inch (2 mm). When you see these “wear bars”, the tire is worn out and should be replaced.

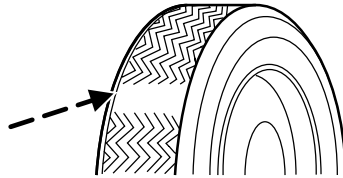

Inspect your tires frequently for any of the following conditions and replace them if one or more of the following conditions exist:

- Fabric showing through the tire rubber
- Bulges in the tread or sidewalls
- Cracks or cuts on the sidewalls
- Cracks in the tread groove
- Impact damage resulting from use
- Separation in the tread
- Separation in the sidewall

## Maintenance and Specifications

- Severe abrasion on the sidewall

If your vehicle has a leak in the exhaust system, a road tire or the spare tire may be exposed to hot exhaust temperatures requiring the tire to be replaced.

### Safety practices

Driving habits have a great deal to do with your tire mileage and safety.

- Observe posted speed limits
- Avoid fast starts, stops and turns
- Avoid potholes and objects on the road
- Do not run over curbs or hit the tire against a curb when parking

If your vehicle is stuck in snow, mud, sand, etc., **do not** rapidly spin the tires; spinning the tires can tear the tire and cause an explosion. A tire can explode in as little as three to five seconds.



Tire explosions can cause death, personal injury or property damage. Do not allow anyone to stand near, directly ahead or behind the spinning tire.



Never spin the tires in excess of the 35 mph (55 km/h) point indicated on the speedometer.

### Highway hazards

No matter how carefully you drive there's always the possibility that you may eventually have a flat tire on the highway. Drive slowly to the closest safe area out of traffic. This may further damage the flat tire, but your safety is more important.

If you feel a sudden vibration or ride disturbance while driving, or you suspect your tire or vehicle has been damaged, immediately reduce your speed. Drive with caution until you can safely pull off the road. Stop and inspect the tires for damage. If a tire is under-inflated or damaged, deflate it, remove wheel and replace it with your spare tire and wheel. If you cannot detect a cause, have the vehicle towed to the nearest repair facility or tire dealer to have the vehicle inspected.

### Tire Replacement Requirements

Your vehicle is equipped with tires designed to provide safe ride and handling capability.

358

## Maintenance and Specifications



Only use replacement tires and wheels that are the same size and type (such as P-metric versus LT-metric or all-season versus all-terrain) as those originally provided by Ford. Use of any tire or wheel not recommended by Ford can affect the safety and performance of your vehicle, which could result in an increased risk of loss of vehicle control, vehicle rollover, personal injury and death. Additionally the use of non-recommended tires and wheels could cause steering, suspension, axle or transfer case/power transfer unit failure. If you have questions regarding tire replacement, see an authorized Ford or Lincoln/Mercury dealer.

Make sure all tires and wheels on the vehicle are of the same size, type, tread design, brand, load-carrying capacity and speed rating because it can affect the safety and performance of your vehicle, which could result in an increased risk of loss of vehicle control, vehicle rollover, personal injury and death.

You should replace the spare tire when you replace the other road tires due to the aging of the spare tire.

### Tire pressure monitoring system (TPMS)

When the tire pressure monitoring system warning light is lit, one or more of your tires is significantly under-inflated. You should stop and check your tires as soon as possible,

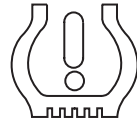

and inflate them to the proper pressure as indicated on the vehicle's tire information placard (label). Driving on a significantly under-inflated tire causes the tire to overheat and can lead to tire failure. Under-inflation also reduces fuel efficiency and tire tread life, and may affect the vehicle's handling and stopping ability. Even if your vehicle is equipped with a tire pressure monitoring system, it is still important that you manually check the inflation pressure of your tires regularly. Each tire, including the spare, should be checked monthly when cold and set to the recommended inflation pressure as specified on the vehicle placard (label) and in the owner's manual.

**Note:** The Tire Pressure Monitoring System (TPMS) monitors tire pressure in each pneumatic tire. The pressure in each tire is dependent upon several factors, one of them being the contained air temperature (temperature of the air inside the tire). As the contained air temperature increases, the tire pressure also increases. While driving in a normal manner, a typical passenger tire inflation pressure may increase

## Maintenance and Specifications

approximately 2 to 4 psi (14 to 28 kPa) from a cold start situation. This increase in tire pressure is due to an increase in the contained air temperature. Contained air temperature is dependent upon several factors such as rate of tire rotation, tire deflection, amount of braking, etc. In similar manner, the tire pressure will decrease if the contained air temperature decreases. For example, if the vehicle is stationary over night with the outside temperature significantly lower than the daytime temperature, the tire pressure may decrease approximately 3 psi (20.7 kPa) for a drop of 30° F (16.6° C) in ambient temperature. This lower pressure value may be detected by the TPMS as being significantly lower than the cold pressure indicated on your vehicles tire label, and activate the TPMS warning for low tire pressure. If the low warning light is on, visually check each tire to verify that no tire is flat. If one or more tires are flat, repair or fix as necessary. If all tires appear to be inflated, carefully drive the vehicle to the nearest location where air can be added to the tires. Turn the ignition to the “off” position. Inflate all the tires to the recommended cold pressure.

The system uses radio-frequency to monitor the tire pressure on all tires excluding the spare tire. The sensors transmit the tire pressure readings to the receiver module located in the vehicle. The receiver module then electronically transmits the status to the message center. For more tire warning information, refer to the *Message Center* in the *Driver controls* chapter.

This device complies with part 15 of the FCC rules and with RS-210 of Industry Canada. Operation is subject to the following two conditions: (1) This device may not cause harmful interference, and (2) This device must accept any interference received, including interference that may cause undesired operation.



The tire pressure monitoring system is NOT a substitute for manually checking tire pressure. The tire pressure should be checked periodically (at least monthly) using a tire gauge, see *Tire inflation pressure* in this chapter. Failure to properly maintain your tire pressure could increase the risk of tire failure, loss of control, vehicle rollover and personal injury.



## Maintenance and Specifications

### Changing tires with TPMS

It is recommended that you always have your tires serviced by a dealer or qualified technician. **Each road tire is equipped with a tire pressure sensor mounted on the wheel inside the tire connected to the valve stem. The tire pressure sensor must be unbolted from the wheel prior to tire removal. The sensor can be removed by loosening the nut at the valve stem. Failure to remove the sensor may damage it.** The rubber grommet (washer) between the wheel and the tire pressure sensor needs to be replaced when any tire is changed to minimize air leaks.

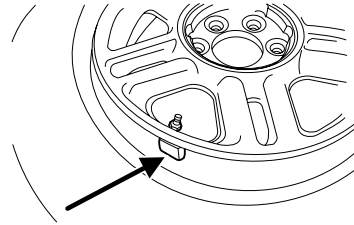

The tire pressure should be checked periodically (at least monthly) using a tire gauge, refer to *Tire inflation pressure* in this chapter.

### SNOW TIRES AND CHAINS



Snow tires must be the same size and grade as the tires you currently have on your vehicle.

The tires on your vehicle have all weather treads to provide traction in rain and snow. However, in some climates, you may need to use snow tires and chains.

Follow these guidelines when using snow tires and chains:

- Use only cable type chains or chains offered by Ford as an accessory or equivalent. Other conventional link type chains may contact and cause damage to the vehicle's wheel house and/or body.
- Do not install chains on the front wheels. Chains on the front wheels may interfere with suspension components.
- Chains are not recommended for use on the optional P275/65R18 tire.
- Install chains securely, verifying that the chains do not touch any wiring, brake lines or fuel lines.
- Drive cautiously. If you hear the chains rub or bang against your vehicle, stop and re-tighten the chains. If this does not work, remove the chains to prevent damage to your vehicle.
- If possible, avoid fully loading your vehicle.

## Maintenance and Specifications

- Remove the tire chains when they are no longer needed. Do not use tire chains on dry roads.
- The suspension insulation and bumpers will help prevent vehicle damage. Do not remove these components from your vehicle when using snow tires and chains.
- Do not exceed 30 mph (48 km/h) with tire chains on your vehicle.

### MOTORCRAFT PART NUMBERS

Component	5.4L 4V V8 engine
Air filter element	FA-1634
Battery	BXT-65-650
Fuel filter	FG-986B
Oil filter	FL-820-S
PCV valve	<sup>1</sup>
Spark plugs	<sup>2</sup>

<sup>1</sup>The PCV valve is a critical emission component. It is one of the items listed in the *Scheduled Maintenance Guide* and is essential to the life and performance of your vehicle and to its emissions system.

For PCV valve replacement, see your dealer or a qualified service technician. Refer to the *Scheduled Maintenance Guide* for the appropriate intervals for changing the PCV valve.

**Replace the PCV valve with one that meets Ford material and design specifications for your vehicle, such as a Motorcraft or equivalent replacement part. The customer warranty may be void for any damage to the emissions system if such a PCV valve is not used.**

<sup>2</sup>For spark plug replacement, see your dealer or a qualified service technician. Refer to the *Scheduled Maintenance Guide* for the appropriate intervals for changing the spark plugs.

**Replace the spark plugs with ones that meet Ford material and design specifications for your vehicle, such as Motorcraft or equivalent replacement parts. The customer warranty may be void for any damage to the engine if such spark plugs are not used.**

Refer to Vehicle Emissions Control Information (VECI) decal for spark plug gap information.

## Maintenance and Specifications

### REFILL CAPACITIES

Fluid	Ford Part Name	Application	Capacity
Brake fluid	Motorcraft High Performance DOT 3 Motor Vehicle Brake Fluid	All	Fill to line on reservoir
Engine oil (includes filter change) <sup>6</sup>	Motorcraft SAE 5W-20 Premium Synthetic Blend Motor Oil (US) Motorcraft SAE 5W-20 Super Premium Motor Oil (Canada)	All	6.6L (7.0 quarts)
Fuel tank	N/A	All	106 L (28 gallons)
Power steering fluid	Motorcraft MERCON® ATF	All	Fill to line on reservoir
Transmission fluid <sup>1</sup>	Motorcraft MERCON®ATF	4 x 2 vehicles	15.0L (15.9 quarts) <sup>2</sup>
		4 x 4 vehicles	15.5L (16.4 quarts) <sup>2</sup>
Transfer case fluid	Motorcraft MERCON®ATF	4 x 4 vehicles	1.9L (2.0 quarts)

## Maintenance and Specifications

Fluid	Ford Part Name	Application	Capacity
Engine coolant <sup>3</sup>	Motorcraft Premium Gold Engine Coolant (yellow-colored)	Base radiator without aux rear heat	18.4L (19.4 quarts)
		Base radiator with aux rear heat	19.6L (20.7 quarts)
		Heavy Duty Trailer Tow radiator without aux rear heat	18.6L (19.7 quarts)
		Heavy Duty Trailer Tow radiator with aux rear heat	19.8L (20.9 quarts)
Front axle lubricant	Motorcraft SAE 75W-90 Fuel Efficient High Performance Synthetic Rear Axle Lubricant	4 x 4 vehicles	1.8-2.0L (3.5-3.7 pints)
Rear axle lubricant <sup>4</sup>	Motorcraft SAE 75W-90 Fuel Efficient High Performance Synthetic Rear Axle Lubricant	Conventional differential (9.75 inch axle)	2.13L (4.5 pints)
		Limited-slip differential (9.75 inch axle) <sup>5</sup>	2.01L (4.25 pints) <sup>5</sup>
Windshield washer fluid	Motorcraft Premium Windshield Washer Concentrate	All	4.1L (4.5 quarts)

## Maintenance and Specifications

<sup>1</sup>Ensure the correct automatic transmission fluid is used. Transmission fluid requirements are indicated on the dipstick or on the dipstick handle. Check the container to verify the fluid being added is of the correct type. Refer to your *Scheduled Maintenance Guide* to determine the correct service interval.

Some transmission fluids may be labeled as dual usage, such as MERCON® and MERCON® V. These dual usage fluids are not to be used in an automatic transmission that requires use of the MERCON® type fluid. However, these dual usage fluids may be used in transmissions that require the MERCON® V type fluid.

**MERCON® and MERCON® V type fluids are not interchangeable. DO NOT mix MERCON® and MERCON® V. Use of a transmission fluid that indicates dual usage (MERCON® and MERCON® V) in an automatic transmission application requiring MERCON® may cause transmission damage. Use of any fluid other than the recommended fluid may cause transmission damage.**

<sup>2</sup>Indicates only approximate dry-fill capacity. Some applications may vary based on cooler size and if equipped with an in-tank cooler. The amount of transmission fluid and fluid level should be set by the indication on the dipstick's normal operating range.

<sup>3</sup>Add the coolant type originally equipped in your vehicle.

<sup>4</sup>Your vehicle's rear axle is filled with a synthetic rear axle lubricant and is considered lubricated for life. These lubricants are not to be checked or changed unless a leak is suspected, service is required or the axle has been submerged in water. The axle lubricant should be changed any time the axle has been submerged in water.

Service refill capacities are determined by filling the rear axle 23mm (0.9 inch) below the bottom of the filler hole.

<sup>5</sup>Add 118 ml (4 oz.) of Additive Friction Modifier XL-3 or equivalent meeting Ford specification EST-M2C118-A for complete refill of Limited Slip axles. For complete refills, fill using the Additive Friction Modifier first.

<sup>6</sup>Use of synthetic or synthetic blend motor oil is not mandatory. Engine oil need only meet the requirements of Ford specification WSS-M2C153-H and the API Certification mark.

## Maintenance and Specifications

### LUBRICANT SPECIFICATIONS

Item	Ford part name	Ford part number	Ford specification
Hinges, latches, striker plates and rotors, seat tracks, fuel filler door hinge and spring	Multi-Purpose Grease	XG-4 or XL-5	ESR-M1C159-A or ESB-M1C93-B
Lock cylinders	Penetrating and Lock Lubricant	Motorcraft XL-1	ESB-M2C75-B
Brake fluid	Motorcraft High Performance DOT 3 Motor Vehicle Brake Fluid	PM-1	ESA-M6C25-A and DOT 3
Driveshaft, slip spline, double Cardan joint center ball	Premium Long Life Grease	XG-1-C or XG-1-K	ESA-M1C75-B
Engine coolant	Motorcraft Premium Gold Engine Coolant (yellow-colored)	VC-7-A (U.S., except CA and OR), VC-7-B (CA and OR only)	WSS-M97B51-A1
Engine oil	Motorcraft SAE 5W-20 Premium Synthetic Blend Motor Oil Motorcraft SAE 5W-20 Super Premium Motor Oil (Canada)	XO-5W20-QSP (US) CXO-5W20-LSP12 (Canada)	WSS-M2C153-H and API Certification Mark

## Maintenance and Specifications

Item	Ford part name	Ford part number	Ford specification
4x4 front wheel bearings, 4x4 spindle needle bearings, spindle thrust bearings & front drive axle u-joint/slip spline	High Temperature 4x4 Front Axle & Wheel Bearing Grease	E8TZ-19590-A	ESA-M1C198-A
Automatic transmission <sup>1</sup>	Motorcraft MERCON® ATF	XT-2-QDX	MERCON®
Power steering fluid	Motorcraft MERCON® ATF	XT-2-QDX	MERCON®
Rear axle	Motorcraft SAE 75W-90 Fuel Efficient High Performance Synthetic Rear Axle Lube	XY-75W90-QFEHP	meets API GL-5
Front axle (4X4)	Motorcraft SAE 75W-90 Fuel Efficient High Performance Synthetic Rear Axle Lube	XY-75W90-QFEHP	meets API GL-5
Transfer case (4X4)	Motorcraft MERCON® ATF	XT-2-QDX	MERCON®
Windshield washer fluid	Motorcraft Premium Windshield Washer Concentrate	ZC-32-A	WSB-M8B16-A2

## Maintenance and Specifications

<sup>1</sup>Ensure the correct automatic transmission fluid is used. Transmission fluid requirements are indicated on the dipstick or on the dipstick handle. Check the container to verify the fluid being added is of the correct type. Refer to your *Scheduled Maintenance Guide* to determine the correct service interval.

Some transmission fluids may be labeled as dual usage, such as MERCON® and MERCON® V. These dual usage fluids are not to be used in an automatic transmission that requires use of the MERCON® type fluid. However, these dual usage fluids may be used in transmissions that require the MERCON® V type fluid.

**MERCON® and MERCON® V type fluids are not interchangeable. DO NOT mix MERCON® and MERCON® V. Use of a transmission fluid that indicates dual usage (MERCON® and MERCON® V) in an automatic transmission application requiring MERCON® may cause transmission damage. Use of any fluid other than the recommended fluid may cause transmission damage.**

<sup>2</sup>Add 118 ml (4 oz.) of Additive Friction Modifier XL-3 or equivalent meeting Ford specification EST-M2C118-A for complete refill of Ford Limited Slip rear axles.

### ENGINE DATA

Engine	5.4L 4V V8 engine
Cubic inches	330
Required fuel	91 octane
Firing order	1-3-7-2-6-5-4-8
Ignition system	Coil on plug
Compression ratio	9.5:1

### VEHICLE DIMENSIONS

Vehicle dimensions	4x2 and 4x4 mm (in)
(1) Overall length	5232.0 (206)
(2) Vehicle width (Body)	2000.0 (78.7)
(2) Vehicle width with power running boards, mirrors folded	2029 (79.9)



## Maintenance and Specifications

Vehicle dimensions	4x2 and 4x4 mm (in)
(2) Vehicle width with fixed running boards	2088 (82.2)
(3) Overall height	1975.0 (77.8)
(4) Wheelbase	3018.0 (118.8)
(5) Track - Front	1701.0 (67.0)
(5) Track - Rear	1704.0 (67.1)

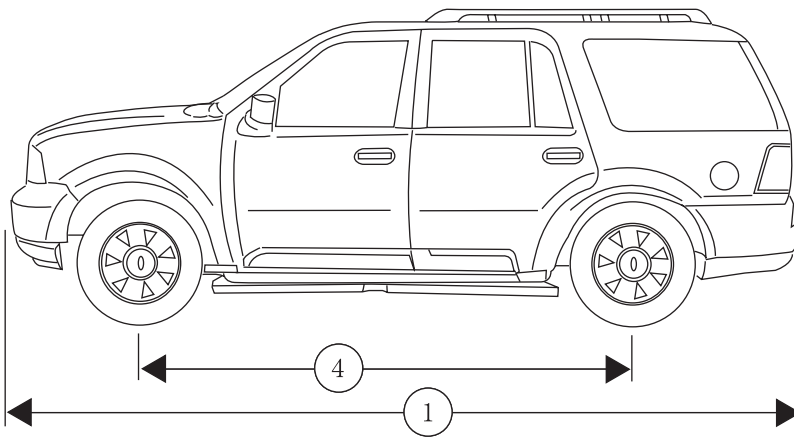

## Maintenance and Specifications

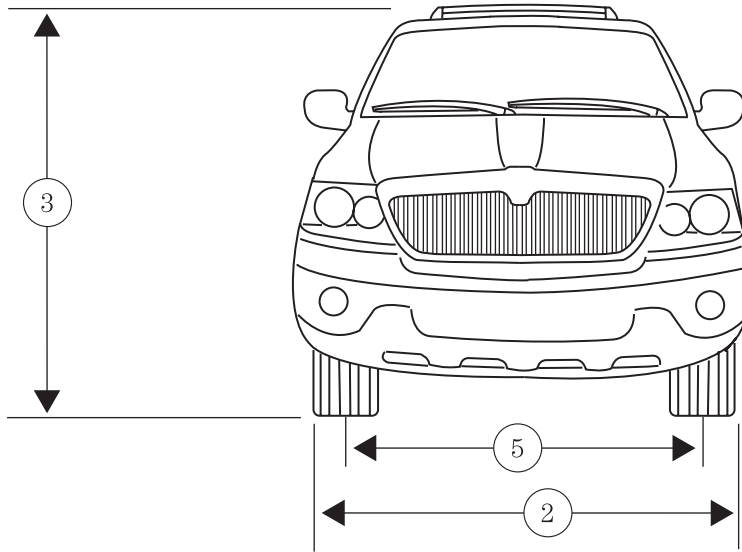

### IDENTIFYING YOUR VEHICLE

#### Certification label

The National Highway Traffic Safety Administration Regulations require that a Certification label be affixed to a vehicle and prescribe where the Certification label may be located. The Certification label is located on the structure by the trailing edge of the driver's door or the edge of the driver's door.

MFD. BY FORD MOTOR CO. IN U.S.A.					
DATE: XX/XX	GVWR: XXXXLB/ XXXXKKG				
FRONT GAWR: XXXXL	REAR GAWR: XXXXLB				
XXXXKKG	WITH	XXXXKKG	WITH		
XXXX/XXXXXXXX	TIRES	XXXX/XXXXXXXX	TIRES		
XXXX.XX	RIMS	XXXX.XX	RIMS		
AT XXX kPa/XX	PSI COLD	AT XXX kPa/XX	PSI COLD		
THIS VEHICLE CONFORMS TO ALL APPLICABLE FEDERAL MOTOR VEHICLE SAFETY AND THEFT PREVENTION STANDARDS IN EFFECT ON THE DATE OF MANUFACTURE SHOWN ABOVE.					
VIN: XXXXXXXXXXXXXXXXX			XXXXX		
TYPE: XXX			XXXXX		
EXT PNT: XX	RC: XX	DSO:			
WB <sup>1</sup> BRK <sup>1</sup> INT TR <sup>1</sup> TP/PS <sup>1</sup> R <sup>1</sup> AXLE <sup>1</sup> TR SPR <sup>1</sup> XXXXX					
XXX X XX X XX X XX XXX					
XXXXXXXXXXXXX UTC V2USA-1520472-AA					

## Maintenance and Specifications

### Vehicle identification number (VIN)

The vehicle identification number is attached to a metal tag and is located on the driver side instrument panel. (Please note that in the graphic XXXX is representative of your vehicle identification number.)

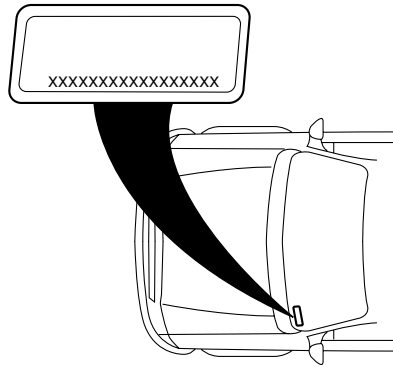

### Engine number

The engine number (the last eight numbers of the vehicle identification number) is stamped on the engine block and transmission.

### Transmission/Transaxle code designations

MFD. BY FORD MOTOR CO. IN U.S.A.									
DATE: XX/XX		GVWR: XXXXXLB/ XXXXXKG							
FRONT GAWR: XXXXL				REAR GAWR: XXXXLB					
XXXXKG	WITH	XXXXKG	WITH	XXXXKG	WITH	XXXXKG	WITH	XXXXKG	WITH
XXXX/XXXXXXXX	TIRES	XXXX/XXXXXXXX	TIRES	XXXX/XXXXXXXX	TIRES	XXXX/XXXXXXXX	TIRES	XXXX/XXXXXXXX	TIRES
XXXX.XX	RIMS	XXXX.XX	RIMS	XXXX.XX	RIMS	XXXX.XX	RIMS	XXXX.XX	RIMS
AT XXX kPa/XX	PSI COLD	AT XXX kPa/XX	PSI COLD	AT XXX kPa/XX	PSI COLD	AT XXX kPa/XX	PSI COLD	AT XXX kPa/XX	PSI COLD
THIS VEHICLE CONFORMS TO ALL APPLICABLE FEDERAL MOTOR VEHICLE SAFETY AND THEFT PREVENTION STANDARDS IN EFFECT ON THE DATE OF MANUFACTURE SHOWN ABOVE.									
VIN: XXXXXXXXXXXXXXXXXXXX								XXXXX	XXXXX
TYPE: XXX									
EXT PNT: XX		RC: XX		DSQ:					
WB	BRK	INT TR	TP/PS	R	AXLE	TR	SPR	XXXXX	XXXXX
XXX	X	XX	X	XX	X	XX	X	XX	XXX
XXXXXXXXXXXX UTC									
*2USA-1520472-AA									

You can find a transmission/transaxle code on the vehicle certification label which is located on the door pillar. The following table tells you which transmission or transaxle each code represents.

## Maintenance and Specifications

### Truck application:

Code	Transmission Description
	<i>Manual transmission</i>
M	Manual 5-speed (AKK)
C	Manual 5-speed overdrive (Close ratio)
W	Manual 5-speed overdrive (Dana ZF)
G	Manual 6-speed ZF
	<i>Automatic transmission</i>
Y	Automatic 4-speed overdrive (CD4E)
U	Automatic 4-speed overdrive (4R70W)
T	Automatic 4-speed overdrive (4R44E)
E	Automatic 4-speed overdrive (4R100)
J	Automatic 5-speed overdrive (5R55E)
	<i>Electric</i>
H	One speed electric
D	Automatic 5-speed overdrive (5R44E)
R	Automatic 5-speed overdrive (5R55S)

## Maintenance and Specifications

**Passenger car application:**

Code	Transmission/Transaxle Description
	<i>Front wheel drive manual transaxle</i>
R	5-speed overdrive (MTX75)
W	5-speed overdrive (M5)
	<i>Front wheel drive automatic transaxle</i>
A	4-speed overdrive (4F27E)
E	4-speed overdrive (4FE)
J	3-speed (Mazda)
L	4-speed overdrive (AX4S)
P	4-speed overdrive (4F20E)
X	4-speed overdrive (4F50N)
Y	4-speed overdrive (CD4E)
	<i>Rear wheel drive manual transaxle</i>
5	5-speed (Mazda M5)
	<i>Rear wheel drive automatic transmission</i>
U	4-speed overdrive (4R70W)
A	5-speed overdrive (5R55N)

## Accessories

### LINCOLN ACCESSORIES FOR YOUR VEHICLE

A wide selection of Genuine Lincoln Accessories are available for your vehicle through your local authorized Lincoln or Ford of Canada dealer. These quality accessories have been specifically engineered to fulfill your automotive needs; they are custom designed to complement the style and aerodynamic appearance of your vehicle. In addition, each accessory is made from high quality materials and meets or exceeds Lincoln's rigorous engineering and safety specifications. Ford Motor Company will repair or replace any properly dealer-installed Genuine Lincoln Accessory found to be defective in factory-supplied materials or workmanship during the warranty period, as well as any component damaged by the defective accessory. The accessory will be warranted for whichever provides you the greatest benefit:

- 12 months or 12,000 miles (20,000 km) (whichever occurs first), or
- the remainder of your new vehicle limited warranty.

This means that Genuine Lincoln Accessories purchased along with your new vehicle and installed by the dealer are covered for the full length of your New Vehicle's Limited Warranty — 4 years or 50,000 miles (80,000 km) (whichever occurs first). Contact your dealer for details and a copy of the warranty.

#### **Not all accessories are available for all models.**

Following is a list of several Lincoln Genuine Accessory products. Not all accessories are available for all models. To find out what accessories are available for your vehicle, please contact your dealer or visit our online store at: [www.lincolnaccessories.com](http://www.lincolnaccessories.com).

#### **Exterior style**

Bug shields  
Deflectors  
Front end covers  
Headlamps, fog lights and Daytime Running Lamps (DRLs)  
Splash guards  
Wheels

#### **Interior style**

Floor mats

374

*2004 Navigator (nav)*  
*Owners Guide (post-2002-fmt)*  
*USA English (fus)*

## Accessories

### Lifestyle

Bike racks

Cargo organization and management

Engine block heaters and blankets

Rear seat entertainment systems

Trailer hitches, wiring harnesses and accessories

### Peace of mind

Airbag anti-theft locks

First aid and safety kits

Full vehicle covers

Locking gas cap

Remote start

Vehicle security systems

For maximum vehicle performance, keep the following information in mind when adding accessories or equipment to your vehicle:

- When adding accessories, equipment, passengers and luggage to your vehicle, do not exceed the total weight capacity of the vehicle or of the front or rear axle (GVWR or GAWR as indicated on the Safety Compliance Certification label). Consult your dealer for specific weight information.
- The Federal Communications Commission (FCC) and Canadian Radio Telecommunications Commission (CRTC) regulate the use of mobile communications systems — such as two-way radios, telephones and theft alarms - that are equipped with radio transmitters. Any such equipment installed in your vehicle should comply with FCC or CRTC regulations and should be installed only by a qualified service technician.
- Mobile communications systems may harm the operation of your vehicle, particularly if they are not properly designed for automotive use.

## Index

### A

ABS (see Brakes) .....235  
Accessory delay .....137  
Air bag supplemental  
restraint system .....210, 214  
and child safety seats .....212  
description .....210, 214  
disposal .....217  
driver air bag .....212, 215  
indicator light .....214, 217  
operation .....212, 215  
passenger air bag .....212, 215  
Air cleaner filter .....345, 362  
Air conditioning  
auxiliary heater and air  
conditioner .....111  
Air suspension .....239  
description .....239  
Antifreeze  
(see Engine coolant) .....326  
Anti-lock brake system  
(see Brakes) .....235–236  
Audio system  
(see Radio) .....16, 21  
Automatic transmission  
driving an automatic  
overdrive .....246  
fluid, adding .....343  
fluid, checking .....343  
fluid, refill capacities .....363  
fluid, specification .....368  
Auxiliary power point .....133  
Axle  
lubricant  
specifications .....366, 368  
refill capacities .....363

### B

Battery .....324

376

acid, treating emergencies .....324  
jumping a disabled battery ....296  
maintenance-free .....324  
replacement, specifications ...362  
servicing .....324  
BeltMinder .....206  
Brakes .....235  
anti-lock .....235–236  
anti-lock brake system (ABS)  
warning light .....236  
fluid, checking and adding ....343  
fluid, refill capacities .....363  
fluid, specifications .....366, 368  
lubricant  
specifications .....366, 368  
parking .....237  
shift interlock .....244  
Bulbs .....117

### C

Calculating load .....269  
Capacities for refilling  
fluids .....363  
CD-single premium .....16  
Cell phone use .....163  
Certification Label .....370  
Changing a tire .....288  
Child safety restraints .....218  
child safety belts .....218  
Child safety seats .....221  
in front seat .....222  
in rear seat .....222  
Cigar lighter  
Power Point .....133  
Cleaning your vehicle  
engine compartment .....313  
instrument panel .....315



## Index

- interior .....315–316
- interior trim .....316
- plastic parts .....314
- safety belts .....315
- washing .....312
- waxing .....312
- wheels .....313
- wiper blades .....314
- Clock .....132
- Clock adjust
  - 6-CD in dash .....23
- Compass, electronic
  - set zone adjustment .....153
- Console .....163
  - overhead .....129, 131
  - rear .....163
- Controls
  - power seat .....185
  - steering column .....144
- Coolant
  - checking and adding .....326
  - refill capacities .....330, 363
  - specifications .....366, 368
- Cruise control
  - (see Speed control) .....141
- Customer Assistance .....277
  - Ford accessories for your vehicle .....317
  - Ford Extended Service Plan .....305
  - Getting assistance outside the U.S. and Canada .....309
  - Getting roadside assistance ...277
  - Getting the service you need .....303
  - Ordering additional owner's literature .....310
  - The Dispute Settlement Board .....305
  - Utilizing the Mediation/Arbitration Program .....308
- D**
- Daytime running lamps
  - (see Lamps) .....114
- Defrost
  - rear window .....112
- Dipstick
  - automatic transmission
    - fluid .....343
    - engine oil .....321
- Doors
  - lubricant specifications .....366
- Driveline universal joint and slip yoke .....345
- Driving under special conditions .....250, 257, 260
  - sand .....259
  - snow and ice .....261
  - through water .....259, 263
- E**
- Electronic message center .....151
- Emergencies, roadside
  - jump-starting .....296
- Emission control system .....339
- Engine .....368
  - cleaning .....313
  - coolant .....326
  - fail-safe coolant .....331
  - idle speed control .....324
  - lubrication
    - specifications .....366, 368
    - refill capacities .....363
    - service points .....320
    - starting after a collision .....278

## Index

- Engine block heater .....234
- Engine oil .....321
- change oil soon warning, message center .....321
  - checking and adding .....321
  - dipstick .....321
  - filter, specifications .....323, 362
  - recommendations .....323
  - refill capacities .....363
  - specifications .....366, 368
- Exhaust fumes .....234
- Extended Rear Park Assist .....250
- F**
- Fail safe cooling .....331
- Floor mats .....164
- Fluid capacities .....363
- Foglamps .....113
- Four-Wheel Drive vehicles .....252
- control trac .....252
  - description .....253
  - driving off road .....255
  - electronic shift .....254
  - indicator light .....252
  - preparing to drive your vehicle .....240
- Fuel .....332
- calculating fuel economy .....154, 336
  - cap .....334
  - capacity .....363
  - choosing the right fuel .....335
  - comparisons with EPA fuel economy estimates .....339
  - detergent in fuel .....336
  - filling your vehicle with fuel .....332, 334, 336
  - filter, specifications .....336, 362
  - fuel pump shut-off switch .....278
  - improving fuel economy .....336
  - octane rating .....335, 368
  - quality .....335
  - running out of fuel .....336
  - safety information relating to automotive fuels .....332
- Fuses .....279–280
- G**
- Garage Door Opener (see Homelink wireless control system) .....147
- Gas cap (see Fuel cap) .....334
- Gas mileage (see Fuel economy) .....336
- Gauges .....14
- GAWR (Gross Axle Weight Rating) calculating .....269
- GVWR (Gross Vehicle Weight Rating) calculating .....269
- H**
- Hazard flashers .....278
- Headlamps .....113
- aiming .....115
  - autolamp system .....113
  - bulb specifications .....117
  - daytime running lights .....114
  - flash to pass .....114
  - high beam .....114
  - replacing bulbs .....118
  - turning on and off .....113
- HomeLink universal transceiver (see Garage door opener) .....151

## Index

- Homelink wireless control system .....147  
Hood .....319
- I**
- Ignition .....231, 368  
Infant seats  
(see Safety seats) .....221  
Inspection/maintenance (I/M)  
testing .....341  
Instrument panel  
  cleaning .....315  
  cluster .....10  
  lighting up panel and  
  interior .....115
- J**
- Jack .....288  
  positioning .....288  
  storage .....288  
Jump-starting your vehicle .....296
- K**
- Keyless entry system  
  autolock .....177  
  programming entry code .....179  
Keys .....180–182  
  positions of the ignition .....231
- L**
- Lamps  
  autolamp system .....113  
  bulb replacement  
  specifications chart .....117  
  daytime running light .....114  
  fog lamps .....113  
  headlamps .....113  
  headlamps, flash to pass .....114  
  instrument panel, dimming ...115  
  interior lamps .....117–118  
  replacing  
  bulbs .....117–118, 120–122, 124
- Lane change indicator  
(see Turn signal) .....116  
Liftgate .....164, 166, 171–172  
Lights, warning and indicator ....10  
  anti-lock brakes (ABS) .....236  
Limited-slip axle .....240  
Load limits .....264  
Loading instructions .....269  
Locks  
  autolock .....177  
  childproof .....169  
  doors .....168  
Lubricant  
  specifications .....366, 368  
Luggage rack .....167  
Lumbar support, seats .....184
- M**
- Message center .....151–152  
  english/metric button .....158  
  system check button .....158  
  warning messages .....159  
Mirrors .....128, 137  
  automatic dimming rearview  
  mirror .....137  
  heated .....139  
  programmable memory ..173, 186  
  side view mirrors (power) .....139  
Moon roof .....129  
Motorcraft parts .....336, 362
- N**
- Navigation system .....43

## Index

- cd functions .....60
  - destination mode .....85
  - DVD location .....107
  - map mode .....64
  - quick start .....45
  - radio functions .....52
- O**
- Octane rating .....335
  - Oil (see Engine oil) .....321
- P**
- Panic alarm feature, remote entry system .....172
  - Parking brake .....237
  - Parts (see Motorcraft parts) .....362
  - Pedals (see Power adjustable foot pedals) .....140
  - Power adjustable foot pedals .....140
  - Power deployable running boards .....151
  - Power distribution box (see Fuses) .....280
  - Power door locks .....168, 177
  - Power liftgate .....164
  - Power Point
    - Cigar lighter .....133
  - Power steering .....238
    - fluid, checking and adding ....342
    - fluid, refill capacity .....363
    - fluid, specifications .....366, 368
  - Power Windows .....134
  - Preparing to drive your vehicle .....240
- 380
- R**
- Radio .....16, 21
  - Rear window defroster .....112
  - Relays .....279
  - Remote entry system .....169, 172
    - illuminated entry .....177
    - locking/unlocking doors .....168–170, 178
    - opening the trunk .....171–172
    - panic alarm .....172
    - replacement/additional transmitters .....175
  - Roadside assistance .....277
  - Roof rack .....167
- S**
- Safety Belt Maintenance .....209
  - Safety belts (see Safety restraints) .....198, 201–205
  - Safety Canopy .....214
  - Safety defects, reporting .....311
  - Safety restraints .....198, 201–205
    - belt minder .....206
    - extension assembly .....209
    - for adults .....202–204
    - for children .....218
    - safety belt maintenance .....209
    - warning light and chime .....205–206
  - Safety seats for children .....221
  - Seat belts (see Safety restraints) .....198
  - Seats .....184
    - child safety seats .....221
    - climate control .....187
    - memory seat .....173, 186

## Index

- SecuriLock passive anti-theft system .....180–182
- Servicing your vehicle .....318
- Setting the clock  
  AM/FM/In-dash 6 CD .....23
- Snowplowing .....7
- Spare tire  
(see Changing the Tire) .....289
- Spark plugs,  
specifications .....362, 368
- Special notice  
  utility-type vehicles .....7
- Specification chart,  
lubricants .....366, 368
- Speed control .....141
- Starting your vehicle .....231–233  
  jump starting .....296
- Steering  
  speed sensitive .....238
- Steering wheel  
  controls .....144
- T**
- Tire Pressure Monitoring System (TPMS)  
  Driving .....259  
  Maintenance and Specifications .....359  
  Roadside Emergencies .....288  
  Warning Displays .....14, 159
- Tires .....288, 346–348  
  alignment .....355  
  care .....353  
  changing .....288–289, 291, 295  
  checking the pressure .....353  
  label .....353  
  replacing .....358
- rotating .....355
- safety practices .....358
- sidewall information .....349
- snow tires and chains .....361
- spare tire .....288
- terminology .....348
- tire grades .....347
- treadwear .....347, 357
- Tonneau cover .....132
- Towing .....269  
  recreational towing .....276  
  trailer towing .....269  
  wrecker .....301
- Transmission .....244  
  brake-shift interlock (BSI) .....244  
  fluid, checking and adding  
  (automatic) .....343  
  fluid, refill capacities .....363  
  lubricant specifications .....366, 368
- Trunk .....171–172
- Turn signal .....116
- V**
- Vehicle dimensions .....368
- Vehicle Identification Number (VIN) .....371
- Vehicle loading .....264
- Ventilating your vehicle .....235
- W**
- Warning lights  
(see Lights) .....10
- Washer fluid .....321
- Water, Driving through .....263

## Index

Windows		checking and adding fluid .....	321
power .....	134	liftgate reservoir .....	321
rear wiper/washer .....	127	replacing wiper blades .....	127
Windshield washer fluid and		Wrecker towing .....	301
wipers .....	126		



