



fordowner.com



ford.ca



2013 F-650/750 Owner's Manual



Table of Contents	1
Introduction	7
Vehicle Inspection Guide	14
Child Safety	26
Child seats28
Child seat positioning28
Booster seats30
Installing child safety seats33
Child safety locks40
Safety Belts	41
Fastening the safety belts42
Safety belt height adjustment47
Safety belt warning light and indicator chime48
Safety belt-minder49
Child restraint and safety belt maintenance51
Keys and Remote Control	52
Keys52
Locks	53
Locking and unlocking53
Steering Wheel	54
Adjusting the steering wheel54
Steering wheel controls54
Wipers and Washers	55
Windshield wipers55
Windshield washers55
Lighting	56
Lighting control56
Instrument lighting dimmer57
Daytime running lamps57
Turn signal control58
Interior lamps58

Windows and Mirrors	59
Power windows59
Exterior mirrors60
Instrument Cluster	64
Gauges64
Warning lamps and indicators68
Audible warnings and indicators73
Information Displays	74
Message center74
Information messages76
Audio System	77
AM/FM stereo79
AM/FM/CD with SYNC80
Auxiliary input jack82
USB port84
Satellite radio information84
Climate Control	88
Manual heating and air conditioning88
Seats	91
Sitting in the correct position91
Head restraints92
Manual seats94
Power seats96
Rear seats98
Heated seats99
Auxiliary Power Points	101
Starting and Stopping the Engine	102
Ignition switch103
Engine block heater111

Table of Contents 3

Fuel and Refueling	113
Fuel quality114
Running out of fuel.116
Refueling117
Fuel consumption.118
Diesel Exhaust Fluid (DEF)120
Transmission	132
Transmission operation136
Brakes	147
Brakes147
Hints on driving with anti-lock brakes151
Traction Control	164
Traction Control™164
Cruise Control	166
Using cruise control166
Driving Aids	168
Steering170
Air suspension171
Upfitter controls.172
Load Carrying	173
Vehicle loading174
Towing	175
Trailer towing.175
Wrecker towing179
Driving Hints	182
Economical driving182

Roadside Emergencies	184
Getting roadside assistance	184
Hazard flasher control	185
Jump-starting the vehicle	185
Customer Assistance	189
Getting assistance outside the U.S. and Canada	191
Reporting safety defects (U.S. only)	193
Reporting safety defects (Canada only)	193
Fuses	194
Changing a fuse	194
Fuse specification chart	195
Fuses and relays	203
Maintenance	204
General information	204
Opening and closing the hood	215
Engine oil dipstick	217
Engine oil check	218
Engine coolant check	219
Automatic transmission fluid check	223
Brake fluid check	229
Power steering fluid check	231
Fuel filter	232
Washer fluid check	232
Changing the vehicle battery	233
Checking the wiper blades	235
Changing the wiper blades	236
Air filter(s)	236
Adjusting the headlamps	239
Changing a bulb	239
Bulb specification chart	241

Table of Contents

5

Vehicle Care	242
Cleaning products242
Cleaning the exterior242
Waxing244
Repairing minor paint damage245
Cleaning the engine245
Cleaning the windows and wiper blades245
Cleaning the interior246
Cleaning the instrument panel and instrument cluster lens247
Cleaning leather seats248
Cleaning the alloy wheels248
Vehicle storage249
Wheels and Tires	252
Tire information252
Wheel lug nut torque262
Capacities and Specifications	263
Engine drivebelt263
Lubricant specifications264
Refill capacities277
Part numbers280
Vehicle identification number281
Vehicle certification label281
Scheduled Maintenance	283

SYNC®	319
Pairing your phone for the first time324
911 Assist™338
Vehicle Health Report341
Appendices	364
Index	372

The information contained in this publication was correct at the time of going to print. In the interest of continuous development, we reserve the right to change specifications, design or equipment at any time without notice or obligation. No part of this publication may be reproduced, transmitted, stored in a retrieval system or translated into any language in any form by any means without our written permission. Errors and omissions excepted.

© Ford Motor Company 2013

ABOUT THIS MANUAL

Thank you for choosing Ford. We recommend that you take some time to get to know your vehicle by reading this manual. The more that you know about it, the greater the safety and pleasure you will get from driving it.



WARNING: Always drive with due care and attention when using and operating the controls and features on your vehicle.

Note: This manual describes a range of product features and options, sometimes before they are generally available. Therefore, you may find options in this manual that are not found on your vehicle.

Note: Some of the illustrations in this manual may be used for different models, so they may appear different than your vehicle. However, the essential information in the illustrations is always correct.

Note: Always use and operate your vehicle in line with all applicable laws and regulations.

Note: Pass on this manual when selling your vehicle. It is an integral part of the vehicle.

This manual may qualify the location of a component as left-hand side or right-hand side. The side is determined when facing forward in the seat.

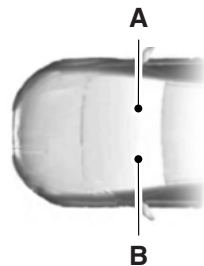

A. Right-hand side

B. Left-hand side

























Protecting the Environment

You must play your part in protecting the environment. Correct vehicle usage and the authorized disposal of waste, cleaning and lubrication materials are significant steps toward this aim.

SYMBOL GLOSSARY





















 **WARNING:** You risk death or serious injury to yourself and others if you do not follow the instruction highlighted by the warning symbol.

These are some of the symbols you may see on your vehicle.

Symbol	Description	Symbol	Description	Symbol	Description
	Safety alert		See Owner's Manual		Anti-lock braking system
	Avoid smoking, flames, or sparks		Battery		Battery acid
	Brake fluid – non petroleum base		Brake system		Cabin air filter
	Check fuel cap		Child Safety Door Lock and Unlock		Child seat lower anchor
	Child seat tether anchor		Cruise control		Do not open when hot
	Engine air filter		Engine coolant		Engine coolant temperature
	Engine oil		Explosive gas		Fan warning
	Fasten safety belt		Front airbag		Front fog lamps

Introduction

9

Symbol	Description	Symbol	Description	Symbol	Description
	Fuel pump reset		Fuse compartment		Hazard warning flasher
	Heated rear window		Interior luggage compartment release		Jack
	Lighting control		Low tire pressure warning		Maintain correct fluid level
	Panic alarm		Parking aid system		Parking brake system
	Power steering fluid		Power windows front and rear		Power window lockout
	Service engine soon		Side airbag		Stability control
	Windshield defrost and demist		Windshield washer and wiper		

DATA RECORDING**Service Data Recording**

Service data recorders in your vehicle are capable of collecting and storing diagnostic information about your vehicle. This potentially includes information about the performance or status of various systems and modules in the vehicle, such as engine, throttle, steering or brake systems. In order to properly diagnose and service your vehicle, Ford Motor Company, Ford of Canada, and service and repair facilities may access or share among them vehicle diagnostic information received through a direct connection to your vehicle when diagnosing or servicing your vehicle. Additionally, when your vehicle is in for service or repair, Ford Motor Company, Ford of Canada, and service and repair facilities may access or share among them data for vehicle improvement purposes. For U.S. only (if equipped), if you choose to use the SYNC® Vehicle Health Report, you consent that certain diagnostic information may also be accessed electronically by Ford Motor Company and Ford authorized service facilities, and that the diagnostic information may be used for any purpose. See the *SYNC®* chapter for more information.

CALIFORNIA PROPOSITION 65

WARNING: Some constituents of engine exhaust, certain vehicle components, certain fluids contained in vehicles and certain products of component wear contain or emit chemicals known to the State of California to cause cancer and birth defects or other reproductive harm.

PERCHLORATE MATERIAL

Note: Certain components in your vehicle, such as airbag modules, safety belt pretensioners, and remote control batteries, may contain perchlorate material. Special handling may apply for service or vehicle end of life disposal. See www.dtsc.ca.gov/hazardouswaste/perchlorate for more information.

FORD CREDIT (U.S. ONLY)

Ford Credit offers a full range of financing and lease plans to help you acquire your vehicle. If you have financed or leased your vehicle through Ford Credit, thank you for your business.

For your convenience, we offer a number of ways to contact us, as well as help manage your account.

Phone: 1-800-727-7000

For more information regarding Ford Credit, as well as access to Account Manager, please go to www.fordcredit.com.

REPLACEMENT PARTS RECOMMENDATION

Your vehicle has been built to the highest standards using quality parts. We recommend that you demand the use of genuine Ford and Motorcraft parts whenever your vehicle requires scheduled maintenance or repair. You can clearly identify genuine Ford and Motorcraft parts by looking for the Ford, FoMoCo or Motorcraft branding on the parts or their packaging.

Scheduled Maintenance and Mechanical Repairs

One of the best ways for you to make sure that your vehicle provides years of service is to have it maintained in line with our recommendations using parts that conform to the specifications detailed in this owner's manual. Genuine Ford and Motorcraft parts meet or exceed these specifications.

Collision Repairs

We hope that you never experience a collision, but accidents do happen. Genuine Ford replacement collision parts meet our stringent requirements for fit, finish, structural integrity, corrosion protection and dent resistance. During vehicle development, we validate that these parts deliver the intended level of protection as a whole system. A great way to know for sure you are getting this level of protection is to use genuine Ford replacement collision parts.

Warranty on Replacement Parts

Genuine Ford and Motorcraft replacement parts are the only replacement parts that benefit from a Ford Warranty. Damage caused to your vehicle as a result of the failure of non-Ford parts may not be covered by the Ford Warranty. For additional information, see the terms and conditions of the Ford Warranty.

SPECIAL NOTICES**New Vehicle Limited Warranty**

For a detailed description of what is covered and what is not covered by your vehicle's New Vehicle Limited Warranty, see the warranty information that is provided to you along with your owner's manual.

Special Instructions

For your added safety, your vehicle is fitted with sophisticated electronic controls.

MOBILE COMMUNICATIONS EQUIPMENT

Using mobile communications equipment is becoming increasingly important in the conduct of business and personal affairs. However, you must not compromise your own or others' safety when using such equipment. Mobile communications can enhance personal safety and security when appropriately used, particularly in emergency situations. Safety must be paramount when using mobile communications equipment to avoid negating these benefits.

Mobile communication equipment includes, but is not limited to, cellular phones, pagers, portable email devices, text messaging devices and portable two-way radios.



WARNING: Driving while distracted can result in loss of vehicle control, crash and injury. We strongly recommend that you use extreme caution when using any device that may take your focus off the road. Your primary responsibility is the safe operation of your vehicle. We recommend against the use of any handheld device while driving and encourage the use of voice-operated systems when possible. Make sure you are aware of all applicable local laws that may affect the use of electronic devices while driving.

FEDERAL HIGHWAY ADMINISTRATION REGULATION

Regulations such as those issued by the Federal Highway Administration or issued pursuant to the Occupational Safety and Health Act (OSHA), and state and local laws and regulations may require additional equipment for the way you intend to use the vehicle. It is the responsibility of the registered owner to determine the applicability of such laws and regulations to your intended use for the vehicle, and to arrange for the installation of required equipment. Your dealer has information about the availability of equipment which may be ordered for your vehicle.

ENTERING, EXITING OR CLIMBING ON THIS VEHICLE

WARNING: Do not carry items while entering, exiting or climbing. Make sure you keep a firm grip. Always FACE the VEHICLE STEP and HANDLE SYSTEM while climbing up and down. Do not climb behind the cab unless you have three point contact with a step and handle system at all times.

You must be careful and deliberate to minimize the possibility of personal injury from a slip and fall when entering, exiting or climbing on this vehicle. Always use the steps and assist handles before climbing. Do not skip any steps or assist handles. Use three point contact at all times with at least two feet and one hand or two hands and one foot firmly placed during all phases of entering, exiting or climbing. Always keep your shoe soles and hands clean. Keep the steps and assist handles free of snow, ice, oil, grease, substances or debris. Be sure to use extra care in bad weather. Avoid wearing thick gloves. Always perform trailer hook-up while standing on the ground.

VEHICLE INSPECTION INFORMATION

To be sure your vehicle is ready to operate, conduct a pre-trip inspection at the beginning of each work period. Follow the steps listed in this section to ensure a proper vehicle inspection procedure. The pages in this section may be produced locally and used on a regular basis.



WARNING: Exercise great caution when working on a vehicle equipped with an automatic fan clutch. The fan starts in motion only after the engine coolant reaches a predetermined temperature or the refrigerant pressure (if equipped with air conditioning) reaches a predetermined setting. The fan starts at this point with no advance warning. Never reach near, or permit objects to protrude into, the fan blade radius while the engine is running as this could result in vehicle damage, personal injury or death.



WARNING: Do not operate the vehicle if any suspension conditions listed in the following charts are evident. Loss of steering or suspension could result in property damage, personal injury or death.



WARNING: If a wheel must be changed, obtain expert tire service help. Mounting and un-mounting of tires should only be performed by a qualified technician using necessary safety procedures and equipment, otherwise the result could be property damage, personal injury or death.

Note: Always make sure the parking brake is applied before starting the engine.

Engine Compartment (with Engine Stopped)	
Engine Oil	Use the dipstick to verify the oil level is in the proper operating range. See <i>Engine oil check</i> in the <i>Maintenance</i> chapter.
Engine Coolant	Look through the plastic reservoir or the clear sight glass on the reservoir (depending upon vehicle equipment) and verify the coolant level is within the proper operating range. Do not remove the pressure cap until the coolant has cooled. See <i>Engine coolant check</i> in the <i>Maintenance</i> chapter.
Power Steering Fluid	Verify that the fluid level is in the proper operating range. See <i>Power steering fluid check</i> in the <i>Maintenance</i> chapter.
Brake Fluid	Remove the master cylinder caps and inspect the fluid level. See <i>Brake fluid check</i> in the <i>Maintenance</i> chapter.
Clutch Fluid	Remove the cap and inspect the fluid level. See <i>Clutch fluid and linkage</i> in the <i>Maintenance</i> chapter.
Belts (Fan, Alternator, Water Pump and A/C Compressor)	Inspect for glazing, fraying or cracking. There should be no more than 5-7 cracks per rib, per inch (2.5 cm).
Fluid Leaks	Inspect for signs of fluid puddles or dripping fluid on the ground under the engine, or the underside of the engine.
HVAC Air Inlet	Inspect for debris that may have collected on the HVAC air inlet grille or inside the exterior module as this may reduce system performance.

Engine Starting (Parking Brake Applied)	
Safety and Emergency Equipment	<ul style="list-style-type: none"> • Before entering the cab, verify that the vehicle is equipped with spare electrical fuses (if used), three red reflective triangles, a properly charged and rated fire extinguisher and wheel chocks. • Walk around the vehicle and verify all steps and grab handles, inside and out (as well as behind), are tight and clean. Use extreme caution and a three-point stance at all times. • Inspect door latches for proper closing, latching and locking.
Starting the Engine	<p>Set the parking brake. If starting a vehicle with a manual transmission, press the clutch and verify the transmission is in neutral. If starting a vehicle with an automatic transmission, make sure the gearshift lever is in position N or P (if equipped with a park position).</p> <p>Diesel engine: Turn the key to the on position. Turn the key to start when the wait to start indicator light in the instrument cluster turns off.</p> <p>Gasoline engine: Turn the key to start, then release it as soon as the engine starts.</p>
Engine Oil Pressure	Verify pressure builds to normal operating range.
Air Chime (If Equipped with an Air Compressor)	The low air pressure warning chime should sound immediately after the engine starts but before the compressor has built-up pressure. The chime should stop when the air pressure reaches 70 psi (483 kPa) (or more). Let the air pressure build to governed cut-out pressure, which should occur between 115–130 psi (793–896 kPa).
Accelerator	Press the accelerator and verify that it operates smoothly, without any binding or irregular feel. Release the pedal and verify the engine returns to idle speed immediately.

Engine Starting (Parking Brake Applied)	
Voltmeter	Check the gauge (diesel engine) or indicator light (gasoline engine) to verify the alternator is charging.
Steering Linkage Free Play	Inspect for excessive free play in the steering linkages. The steering wheel should have less than 2 in. (5 cm) of free play at its rim.
Full Power Hydraulic Brake Inspection	Pump the brake pedal several times with the ignition in the off or run position. The motor/pumps can be heard momentarily replenishing the accumulators.
Parking Brake	Verify the parking brake holds the vehicle by gently trying to pull forward with the parking brake applied.

Engine Starting (Parking Brake Applied)	
Air Brakes	<p>Verify operation using the following procedure. Chock the wheels, if necessary. Push in the parking brake and, on tractors, push in the tractor parking brake knob:</p> <ol style="list-style-type: none"> 1. Verify the air compressor or governor cut-out pressure is approximately 120 psi (827 kPa). 2. Turn off the engine, then turn the key back to the on position (without starting the engine). 3. Without the brake pedal applied, note the air pressure drop for one minute. It should be less than 2 psi (14 kPa) for single vehicles and 3 psi (21 kPa) for combination vehicles. 4. Press and hold the brake pedal with 90 psi (621 kPa) or more. Make sure there is no more than a 3 psi (21 kPa) per minute leak for single vehicles and a 4 psi (28 kPa) per minute leak for combination vehicles. 5. Pump the brake pedal to deplete the system of air pressure. The warning light and chime should activate at 57 psi (393 kPa). 6. Pump the brake pedal and make sure the parking brake and trailer parking brake knobs pop out at 20 psi (138 kPa) or higher.
Automatic Transmission Fluid	<p>Verify that the fluid level is in the proper operating range. See <i>Transmission fluid check</i> in the <i>Maintenance</i> chapter.</p>

Front of Vehicle	
Lights	Verify: <ul style="list-style-type: none"> • all exterior lights illuminate and are clean • headlights function on high and low beam • reflectors are clean, unbroken and of proper color (red on rear, amber elsewhere) • running lights are clean and unbroken.
Steering Gear	Inspect for: <ul style="list-style-type: none"> • missing or loose fasteners • power steering fluid leaks • damage to power steering hoses.
Steering Linkage	Verify: <ul style="list-style-type: none"> • connecting links, arms and rods are not worn or cracked • joints, sockets and boot seals are not worn or loose • cotter keys, nuts and bolts are not loose or missing.
Tow Hooks	Inspect front and rear tow hooks for damage or loose mounting. This is particularly important on vehicles when they are used frequently.

Front Suspension	
Springs	Inspect for leaves that may be: <ul style="list-style-type: none"> • missing • broken • shifted • in contact with (or nearly contacting) a tire, rim, brake drum, frame or body component. Note: Never apply grease to spring pads.
Spring Mounts	Inspect the following for cracks, breaks, wear, damage and tightness: <ul style="list-style-type: none"> • spring hangers • bolts • bushings • axle mounting bolts • nuts.
Shock Absorbers	Inspect for: <ul style="list-style-type: none"> • cracks • leaks • missing or broken bolts or bushings.
Front Brakes	
Hoses	<ul style="list-style-type: none"> • Inspect for cracked, worn or frayed hoses. • Verify all couplings are secured.
Brake Chambers	Verify: <ul style="list-style-type: none"> • there are no cracks or dents • they are securely mounted.
Slack Adjusters	Inspect for broken, loose or missing parts. Note: The angle between the push rod and adjuster arm should be approximately 90° when the brakes are applied. When pulled by hand, the push rod should not move more than approximately one inch (2.5 cm).
Drums	Verify: <ul style="list-style-type: none"> • there are no cracks, dents, holes, and no loose or missing bolts • the brake linings are not worn, dangerously thin or contaminated by lubricant.

Front Wheels	
Rims	Inspect for damaged or bent rims. They should not have welding repairs, and there should be no rust trails that indicate it is loose on the wheel.
Lug Nuts	Verify all lug nuts are present and not loose (look for rust trails around the lug nuts). There should be no cracks radiating from the lug bolt holes or distortion of the bolt holes.
Hub Oil Seals	Inspect wheel hub oil seal for leaks and, if sight glass is present, verify the oil level is adequate.
Oil-lubricated Front Wheel Bearings	Inspect for proper lubrication level if the hubcap has a transparent window. If the hubcap does not have a transparent window, remove the rubber fill-plug and inspect for proper level.
Fuel Area	
Fuel Tank(s)	Verify: <ul style="list-style-type: none"> • tank(s) and cap(s) are secure • there is no damage to the tank(s).
Leaks	Inspect for leaks from the tank(s).
Diesel Exhaust Fluid (DEF) Area	
DEF Tanks	Verify: <ul style="list-style-type: none"> • tanks and caps are secure • there is no damage to the tanks.
Leaks	Inspect for leaks from the tanks.
Underbody	
Driveshaft	Verify: <ul style="list-style-type: none"> • the driveshaft is not bent or cracked • all driveshaft couplings are secure.
Exhaust System	Verify: <ul style="list-style-type: none"> • the visible outside parts are securely mounted • there are no cracks, holes or severe dents.
Frame	<ul style="list-style-type: none"> • Inspect for cracks or bends in longitudinal frame members. • Verify there are no loose, cracked, bent, broken or missing crossmembers or crossmember fasteners.

Rear of Vehicle	
Air Hoses and Electrical Lines	<ul style="list-style-type: none"> • Verify air hoses and electrical line insulation are not cut, cracked, chafed or worn. Listen for audible air leaks. • Verify air and electrical lines are not tangled, crimped or pinched or being dragged against any truck parts. None of the air or electrical line should be spliced or taped. • Inspect for corrosion on pins and in electrical sockets to ensure continuity and reduced heat build-up potential.
Deck Plate	Verify deck plate is clean, securely bolted to the frame and clear of loose objects.
Turns Signals, Brake Lights and Flashers	Verify: <ul style="list-style-type: none"> • both brake lights illuminate when the pedal is applied • each signal flashes • four-way flashers work properly.
Lights and Reflectors	Verify: <ul style="list-style-type: none"> • all exterior lights illuminate and are clean • reflectors are clean, unbroken and of proper color (red on rear, amber elsewhere) • running lights are clean and unbroken. <p>Note: Rear running lights must be inspected separately from signal, flasher and brake lights.</p>

Tractor-Coupling System	
Mounting Bolts	Inspect for loose or missing mounting brackets, clamps, bolts or nuts. Both fifth-wheel and slide mounting must be solidly attached.
Platform	Inspect for cracks or breaks in the platform structure.
Safety Latch	Verify safety latch is engaged.
Release Arm	Verify: <ul style="list-style-type: none"> • the safety latch is in the engaged position • any safety latch is in place.
Kingpin and Apron	Verify: <ul style="list-style-type: none"> • the kingpin is not bent or worn • the apron lies flat on the fifth-wheel skid plate • the visible part of the apron is not bent, worn, cracked or broken.
Rear Suspension	
Springs	<ul style="list-style-type: none"> • Inspect for broken or shifted leaves or leaves that are in contact with (or nearly contacting) a tire, rim, brake drum, frame or body component. • Inspect for missing or broken leaves in the leaf spring.
Spring Mounts	Inspect for: <ul style="list-style-type: none"> • cracked or broken spring hangers • broken, missing or loose bolts • missing or damaged bushings • broken, loose or missing axle mounting parts.
Torsion Arm and Shock Absorbers	<ul style="list-style-type: none"> • Verify torsion arm is not cracked, broken or missing. • Inspect the shock absorber for cracks or leaks. There should be no missing or broken mounting bolts or worn bushings.

Rear Brakes	
Hoses	<ul style="list-style-type: none"> • Inspect for cracked, worn or frayed hoses. • Verify all couplings are secured.
Brake Chambers	Verify: <ul style="list-style-type: none"> • there are no cracks or dents • they are securely mounted.
Slack Adjuster	Inspect for broken, loose or missing parts. Note: The angle between the push rod and adjuster arm should be approximately 90° when the brakes are applied. When pulled by hand, the push rod should not move more than approximately one inch (2.5 cm).
Drum	Verify: <ul style="list-style-type: none"> • there are no cracks, dents, holes and no loose or missing bolts • the brake linings are not worn, dangerously thin or contaminated by lubricant.
Rear Wheels	
Spacers	Verify: <ul style="list-style-type: none"> • dual wheels are evenly separated • the tires are not touching one another.
Rims	Inspect for damaged or bent rims. Rims should not have welding repairs, and no rust trails that indicate it is loose on the wheel.
Lug Nuts	Verify all lug nuts are present and not loose (look for rust trails around the lug nuts). There should be no cracks radiating from the lug bolt holes or distortion of the bolt holes.

Trailer

If you are pulling a trailer, an inspection of the trailer similar to that of the tractor should be done. The inspection should follow trailer manufacturer recommendations and should include at a minimum: general condition, landing gear, doors, sides, lights, reflectors, suspension, brakes, tires, wheels, cargo placement, stability and tie-downs.

Transmission



WARNING: If the unit starts in gear and/or the neutral start switch is not functioning correctly, the vehicle may inadvertently move which could result in property damage, personal injury or death.

If your vehicle is equipped with an automatic transmission, regularly inspect the transmission's neutral start switch. The engine should only start in position **N** or **P**.

Inspect the transmission fluid level and shift linkage for proper operation.

GENERAL INFORMATION

See the following sections for directions on how to properly use safety restraints for children.



WARNING: Always make sure your child is secured properly in a device that is appropriate for their height, age and weight. Child safety restraints must be bought separately from your vehicle. Failure to follow these instructions and guidelines may result in an increased risk of serious injury or death to your child.



WARNING: All children are shaped differently. The recommendations for safety restraints are based on probable child height, age and weight thresholds from NHTSA and other safety organizations, or are the minimum requirements of law. Ford recommends checking with a NHTSA Certified Child Passenger Safety Technician (CPST) and consulting your pediatrician to make sure your child seat is appropriate for your child, and is compatible with and properly installed in your vehicle. To locate a child seat fitting station and CPST, contact the NHTSA toll free at 1-888-327-4236 or on the internet at <http://www.nhtsa.dot.gov>. In Canada, check with your local St. John Ambulance office for referral to a CPST or for further information, contact your provincial ministry of transportation, or locate your local St. John Ambulance office by searching for St. John Ambulance on the internet, or Transport Canada at 1-800-333-0371 (<http://www.tc.gc.ca>). Failure to properly restrain children in safety seats made especially for their height, age, and weight may result in an increased risk of serious injury or death to your child.

Recommendations for Safety Restraints for Children		
	Child size, height, weight, or age	Recommended restraint type
Infants or toddlers	Children weighing 40 lb (18 kg) or less (generally age four or younger).	Use a child safety seat (sometimes called an infant carrier, convertible seat, or toddler seat).
Small children	Children who have outgrown or no longer properly fit in a child safety seat (generally children who are less than 4 ft. 9 in. (1.45 m) tall, are greater than age four (4) and less than age twelve (12), and between 40 lb (18 kg) and 80 lb (36 kg) and upward to 100 lb (45 kg) if recommended by your child restraint manufacturer).	Use a belt-positioning booster seat.
Larger children	Children who have outgrown or no longer properly fit in a belt-positioning booster seat (generally children who are at least 4 ft. 9 in. (1.45 m) tall or greater than 80 lb (36 kg) or 100 lb (45 kg) if recommended by child restraint manufacturer).	Use a vehicle safety belt having the lap belt snug and low across the hips, shoulder belt centered across the shoulder and chest, and seat back upright.

- You are required by law to properly use safety seats for infants and toddlers in the United States and Canada.
- Many states and provinces require that small children use approved booster seats until they reach age eight, a height of 4 feet 9 inches (1.45 meters) tall, or 80 pounds (36 kilograms). Check your local and state or provincial laws for specific requirements about the safety of children in your vehicle.
- When possible, always properly restrain children twelve (12) years of age and under in a rear seating position of your vehicle. Accident statistics suggest that children are safer when properly restrained in the rear seating positions than in a front seating position. See *Front Passenger Sensing System* in the *Supplementary Restraints System* chapter for more information.

CHILD SEATS

Use a child safety seat (sometimes called an infant carrier, convertible seat, or toddler seat) for infants, toddlers or children weighing 40 pounds (18 kilograms) or less (generally age four or younger).

CHILD SEAT POSITIONING

WARNING: Airbags can kill or injure a child in a child seat.

Never place a rear-facing child seat in front of an active airbag. If you must use a forward-facing child seat in the front seat, move the vehicle seat upon which the child seat is installed all the way back. When possible, all children age 12 and under should be properly restrained in a rear seating position. If all children cannot be seated and restrained properly in a rear seating position, properly restrain the largest child in the front seat.



WARNING: Always carefully follow the instructions and

warnings provided by the manufacturer of any child restraint to determine if the restraint device is appropriate for your child's size, height, weight, or age. Follow the child restraint manufacturer's instructions and warnings provided for installation and use in conjunction with the instructions and warnings provided by your vehicle manufacturer. A safety seat that is improperly installed or utilized, is inappropriate for your child's height, age, or weight or does not properly fit the child may increase the risk of serious injury or death.





WARNING: Never let a passenger hold a child on his or her lap

while your vehicle is moving. The passenger cannot protect the child from injury in a crash, which may result in serious injury or death.

 **WARNING:** Never use pillows, books, or towels to boost a child. They can slide around and increase the likelihood of injury or death in a crash.

 **WARNING:** Always restrain an unoccupied child seat or booster seat. These objects may become projectiles in a crash or sudden stop, which may increase the risk of serious injury.

 **WARNING:** Never place, or allow a child to place, the shoulder belt under a child’s arm or behind the back because it reduces the protection for the upper part of the body and may increase the risk of injury or death in a crash.

 **WARNING:** To avoid risk of injury, do not leave children or pets unattended in your vehicle.

Restraint Type	Child Weight	Use any attachment method as indicated below by “X”				
		LATCH (lower anchors and top tether anchor)	LATCH (lower anchors only)	Safety belt and top tether anchor	Safety belt and LATCH (lower anchors and top tether anchor)	Safety belt only
Rear facing child seat	Up to 48 lb (21 kg)					X
Forward facing child seat	Up to 48 lb (21 kg)			X		
Forward facing child seat	Over 48 lb (21 kg)			X		

Note: The child seat must rest tightly against the vehicle seat upon which it is installed. It may be necessary to lift or remove the head restraint. See the *Seats* chapter for information on head restraints.

BOOSTER SEATS



WARNING: Never place, or allow a child to place, the shoulder belt under a child's arm or behind the back because it reduces the protection for the upper part of the body and may increase the risk of injury or death in a crash.

Use a belt-positioning booster seat for children who have outgrown or no longer properly fit in a child safety seat (generally children who are less than 4 feet 9 inches (1.45 meters) tall, are greater than age four (4) and less than age twelve (12), and between 40 pounds (18 kilograms) and 80 pounds (36 kilograms) and upward to 100 pounds (45 kilograms) if recommended by your child restraint manufacturer). Many state and provincial laws require that children use approved booster seats until they reach age eight (8), a height of 4 feet 9 inches (1.45 meters) tall, or 80 pounds (36 kilograms).

Booster seats should be used until you can answer YES to ALL of these questions when the child is seated without a booster seat.

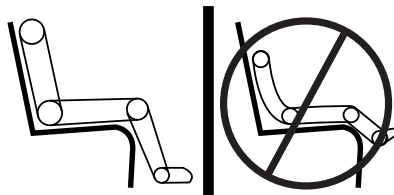

- Can the child sit all the way back against their vehicle seat with knees bent comfortably at the edge of the seat cushion?
- Can the child sit without slouching?
- Does the lap belt rest low across the hips?
- Is the shoulder belt centered on the shoulder and chest?
- Can the child stay seated like this for the whole trip?

Always use booster seats in conjunction with your vehicle lap and shoulder belt.

Types of Booster Seats

- Backless booster seats

If your backless booster seat has a removable shield, remove the shield. If a vehicle seating position has a low seat back or no head restraint, a backless booster seat may place your child's head (as measured at the tops of the ears) above the top of the seat. In this case, move the backless booster to another seating position with a higher seat back or head restraint and lap and shoulder belts, or consider using a high back booster seat.



- High back booster seats

If, with a backless booster seat, you cannot find a seating position that adequately supports your child's head, a high back booster seat would be a better choice.

Children and booster seats vary in size and shape. Choose a booster that keeps the lap belt low and snug across the hips, never up across the stomach, and lets you adjust the shoulder belt to cross the chest and rest snugly near the center of the shoulder. The following drawings compare the ideal fit (center) to a shoulder belt uncomfortably close to the neck and a shoulder belt that could slip off the shoulder. The drawings also show how the lap belt should be low and snug across the child's hips.

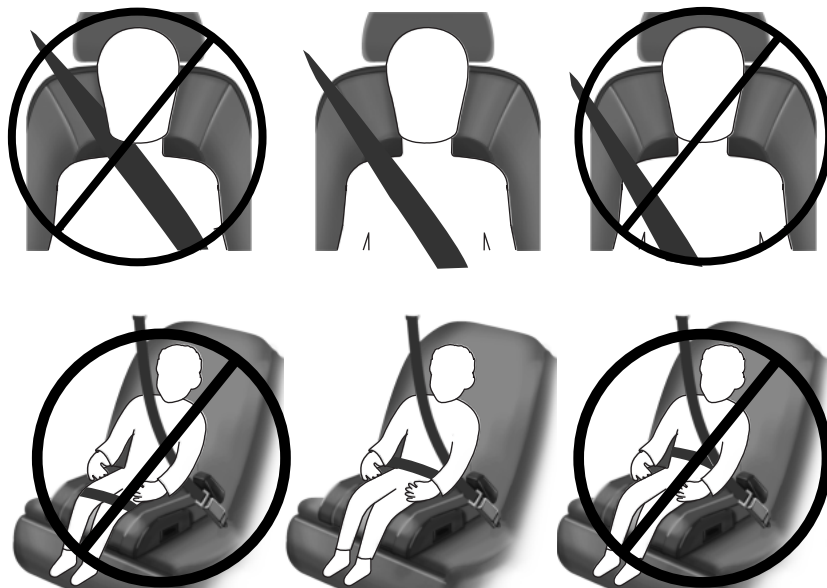

If the booster seat slides on the vehicle seat upon which it is being used, placing a rubberized mesh sold as shelf or carpet liner under the booster seat may improve this condition. Do not introduce any item thicker than this under the booster seat. Check with the booster seat manufacturer's instructions.

INSTALLING CHILD SAFETY SEATS**Using Automatic Locking Mode Combination Lap and Shoulder Belts (Front Passenger and Rear Outboard Seating Positions)**

WARNING: Children 12 and under should be properly restrained in the rear seat whenever possible.



WARNING: Depending on where you secure a child restraint, and depending on the child restraint design, you may block access to certain safety belt buckle assemblies and/or LATCH lower anchors, rendering those features potentially unusable. To avoid risk of injury, occupants should only use seating positions where they are able to be properly restrained.

When installing a child safety seat with combination lap/shoulder belts:

- Use the correct safety belt buckle for that seating position.
- Insert the belt tongue into the proper buckle until you hear a snap and feel it latch. Make sure the tongue is securely fastened in the buckle.
- Keep the buckle release button pointing up and away from the safety seat, with the tongue between the child seat and the release button, to prevent accidental unbuckling.
- Place the vehicle seat back in the upright position.
- This vehicle does not require the use of a locking clip.

Perform the following steps when installing the child seat with combination lap/shoulder belts:

Note: Although the child seat illustrated is a forward-facing child seat, the steps are the same for installing a rear-facing child seat.



1. Position the child safety seat in a seat with a combination lap and shoulder belt.

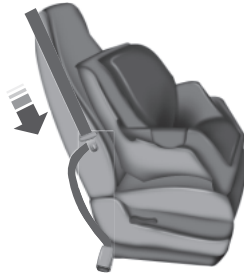

2. Pull down on the shoulder belt and then grasp the shoulder belt and lap belt together.

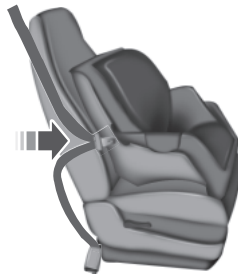

3. While holding the shoulder and lap belt portions together, route the tongue through the child seat according to the child seat manufacturer's instructions. Be sure the belt webbing is not twisted.

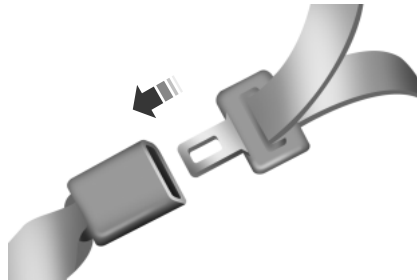

4. Insert the belt tongue into the proper buckle (the buckle closest to the direction the tongue is coming from) for that seating position until you hear a snap and feel the latch engage. Make sure the tongue is latched securely by pulling on it.



5. To put the retractor in the automatic locking mode, grasp the shoulder portion of the belt and pull downward until all of the belt is pulled out.

- Allow the belt to retract to remove slack. The belt will click as it retracts to indicate it is in the automatic locking mode.

6. Try to pull the belt out of the retractor to make sure the retractor is in the automatic locking mode (you should not be able to pull more belt out). If the retractor is not locked, unbuckle the belt and repeat Step 5.

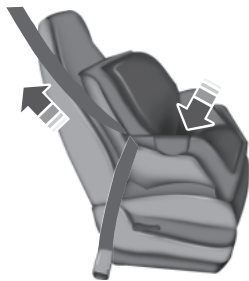

7. Remove remaining slack from the belt. Force the seat down with extra weight (e.g., by pressing down or kneeling on the child restraint while pulling up on the shoulder belt in order to force slack from the belt).

This is necessary to remove the remaining slack that exists once the additional weight of the child is added to the child restraint. It also helps to achieve the proper snugness of the child seat to the vehicle. Sometimes, a slight lean toward the buckle helps to remove remaining slack from the belt.

8. Attach the tether strap (if the child seat is equipped). See *Using tether straps* in this chapter.

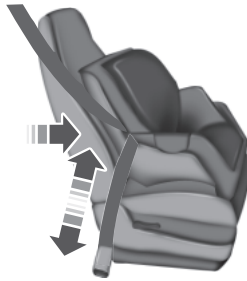

9. Before placing the child in the seat, forcibly move the seat forward and back to make sure the seat is securely held in place.

To check this, grab the seat at the belt path and attempt to move it side to side and forward and back. There should be no more than one inch (two and a half centimeters) of movement for proper installation.

Ford recommends checking with a NHTSA Certified Child Passenger Safety Technician (CPST) to make certain the child restraint is properly installed. In Canada, check with your local St. John Ambulance office for referral to a CPST.

Using Lower Anchors and Tethers for Children (LATCH)

The LATCH system is composed of three vehicle anchor points: two lower anchors located where the vehicle seat back and seat cushion meet (called the seat bight) and one top tether anchor located behind that seating position. Your vehicle is not equipped with the lower anchor points in the seat bight. For this vehicle, use the vehicle safety belt and upper tether to secure a child seat. See *Using Tether Straps and Recommendations for Safety Restraints for Children* in this chapter for more information.

USING TETHER STRAPS

Many forward-facing child safety seats include a tether strap which extends from the back of the child safety seat and hooks to an anchoring point called the top tether anchor. Tether straps are available as an accessory for many older safety seats. Contact the manufacturer of your child seat for information about ordering a tether strap, or to obtain a longer tether strap if the tether strap on your safety seat does not reach the appropriate top tether anchor in the vehicle.

The passenger seats of your vehicle may be equipped with built-in tether strap anchors located behind the seats as described below.

The tether anchors in your vehicle may be straps on the seat back or an anchor bracket mounted to the body shell on the back panel.

The tether strap anchors in your vehicle are in the following positions (shown from top view):

- **Regular Cab**

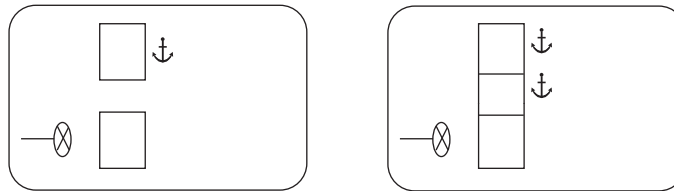

- **Crew Cab**

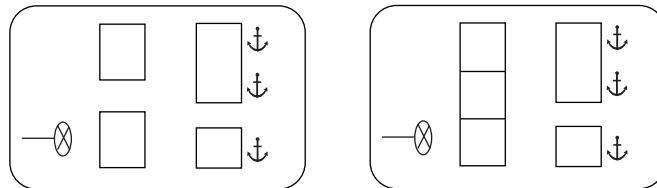

Attach the tether strap only to the appropriate tether anchor as shown. The tether strap may not work properly if attached somewhere other than the correct tether anchor.

Once the child safety seat has been installed using the safety belt, you can attach the top tether strap.

Tether Strap Attachment

1. Route the child safety seat tether strap over the back of the seat.

For vehicles with adjustable head restraints, route the tether strap under the head restraint and between the head restraint posts, otherwise route the tether strap over the top of the seat back. If the top of the safety seat hits the head restraint, raise the head restraint to let the child seat fit further rearward.

2. Locate the correct anchor for the selected seating position.

3. You may need to pull the seat back forward to access the tether anchors. Make sure the seat is locked in the upright position before installing the child seat.

4. Clip the tether strap to the anchor as shown:

- Front seats (Regular Cab) and Rear seats (Crew Cab)

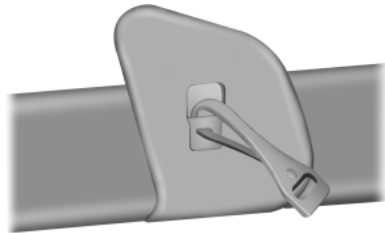

If the tether strap is clipped incorrectly, the child safety seat may not be retained properly in the event of a crash.

5. Tighten the child safety seat tether strap according to the manufacturer's instructions.

If the safety seat is not anchored properly, the risk of a child being injured in a crash greatly increases.

If your child restraint system is equipped with a tether strap, and the child restraint manufacturer recommends its use, Ford also recommends its use.

Tether Strap Attachment (Rear SuperCab Only)

There are three loops of webbing just above the back of the rear seat (along the bottom edge of the rear window) in the SuperCab. These loops are to be used as both routing loops and anchor loops for up to three child safety seat tether straps.

These straps may be secured below the back of the seat with rubber bands. To access, reach below the back of the seat and pull the tether loop out of the rubber band securing it.

Many tether straps cannot be tightened if the tether strap is hooked to the loop directly behind the child seat. To provide a tight tether strap:

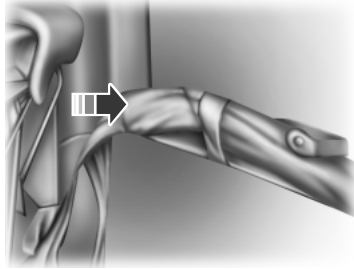

1. Route the tether strap through the loop directly behind the child seat.

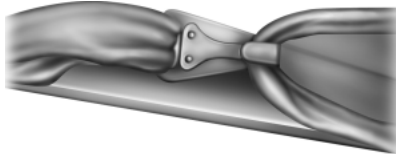

2. Attach the strap hook onto the loop behind an adjacent seating position.

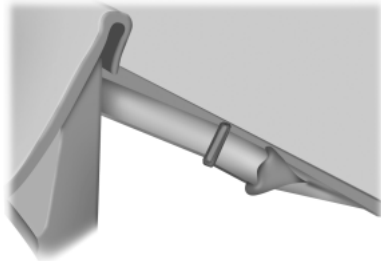

3. Install the child safety seat tightly using the vehicle belts. Follow the instructions in this chapter.

4. Tighten the tether strap according to the child seat manufacturer's instructions.

A single loop can be used to route and anchor more than one child seat. For example, the center loop can be used as a routing loop for a child safety seat in the center rear seat and as an anchoring loop for child seats installed in the outboard rear seats.

CHILD SAFETY LOCKS (IF EQUIPPED)

When these locks are set, the rear doors cannot be opened from the inside.



The childproof locks are located on the rear edge of each rear door and must be set separately for each door.

Move the lock control up or down to engage or disengage the childproof lock.

PRINCIPLES OF OPERATION



WARNING: Always drive and ride with your seat back upright and the lap belt snug and low across the hips.



WARNING: To reduce the risk of injury, make sure children sit where they can be properly restrained.



WARNING: Never let a passenger hold a child on his or her lap while the vehicle is moving. The passenger cannot protect the child from injury in a crash.



WARNING: All occupants of the vehicle, including the driver, should always properly wear their safety belts, even when an airbag supplemental restraint system (SRS) is provided.



WARNING: It is extremely dangerous to ride in a cargo area, inside or outside of a vehicle. In a crash, people riding in these areas are more likely to be seriously injured or killed. Do not allow people to ride in any area of your vehicle that is not equipped with seats and safety belts. Be sure everyone in your vehicle is in a seat and using a safety belt properly.



WARNING: In a rollover crash, an unbelted person is significantly more likely to die than a person wearing a safety belt.



WARNING: Each seating position in your vehicle has a specific safety belt assembly which is made up of one buckle and one tongue that are designed to be used as a pair. 1) Use the shoulder belt on the outside shoulder only. Never wear the shoulder belt under the arm. 2) Never swing the safety belt around your neck over the inside shoulder. 3) Never use a single belt for more than one person.



WARNING: When possible, all children 12 years old and under should be properly restrained in a rear seating position.



WARNING: Safety belts and seats can become hot in a vehicle that has been closed up in sunny weather; they could burn a small child. Check seat covers and buckles before you place a child anywhere near them.



WARNING: Front and rear seat occupants, including pregnant women, should wear safety belts for optimum protection in an accident.

The front and rear outboard safety restraints in the vehicle are combination lap and shoulder belts. The front and rear seat passenger outboard safety belts have vehicle sensitive emergency locking retractors and automatic locking retractors.

The safety belt system consists of:

- Lap and shoulder safety belts.
- Shoulder safety belt with automatic locking mode (except driver safety belt).
- Height adjuster at the front outboard seating positions.
-  Safety belt warning light and chime. See *Safety belt warning light and indicator chime* later in this chapter.

FASTENING THE SAFETY BELTS

The front and rear outboard safety restraints in the vehicle are combination lap and shoulder belts.

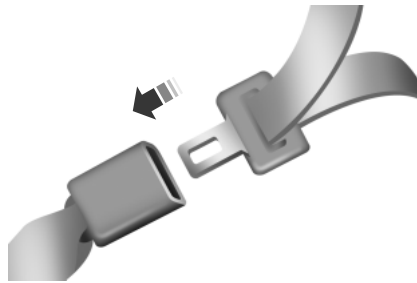

1. Insert the belt tongue into the proper buckle (the buckle closest to the direction the tongue is coming from) until you hear a snap and feel it latch. Make sure the tongue is securely fastened in the buckle.

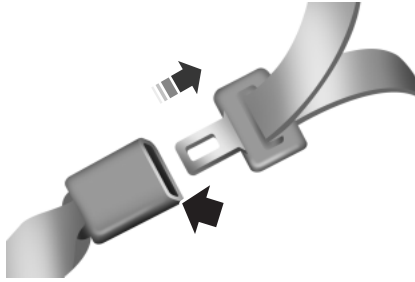

2. To unfasten, press the release button and remove the tongue from the buckle.

Using the Safety Belt with Cinch Tongue (Front and Rear Center Seat)

The cinch tongue slides up and down the belt webbing when the belt is stowed or while putting safety belts on. When the lap and shoulder safety belt is buckled, the cinch tongue allows the lap portion to be shortened, but pinches the webbing to keep the lap portion from getting longer. The cinch tongue is designed to slip during a crash, so always wear the shoulder belt properly and do not allow any slack in either the lap or shoulder portions.

Before you can reach and latch a lap and shoulder belt having a cinch tongue into the buckle, you may have to lengthen the lap belt portion of it.



1. To lengthen the lap belt, pull some webbing out of the shoulder belt retractor.
2. While holding the webbing below the tongue, grasp the tip (metal portion) of the tongue so that it is parallel to the webbing and slide the tongue upward.
3. Provide enough lap belt length so that the tongue can reach the buckle.

Fastening the Cinch Tongue

WARNING: The lap belt should fit snugly and as low as possible around the hips, not across the waist.

1. Pull the lap and shoulder belt from the retractor so that the shoulder belt portion of the safety belt crosses your shoulder and chest.
2. Be sure the belt is not twisted. If the belt is twisted, remove the twist.
3. Insert the belt tongue into the proper buckle for your seating position until you hear a snap and feel it latch.
4. Make sure the tongue is securely fastened to the buckle by pulling on the tongue.

While you are fastened in the safety belt, the lap and shoulder belt with a cinch tongue adjusts to your movement. However, if you brake hard, turn hard, or if your vehicle receives an impact of 5 mph (8 km/h) or more, the safety belt becomes locked and helps reduce your forward movement.

Restraint of Pregnant Women

WARNING: Always ride and drive with your seat back upright and the safety belt properly fastened. The lap portion of the safety belt should fit snug and be positioned low across the hips. The shoulder portion of the safety belt should be positioned across the chest. Pregnant women should also follow this practice. See the following figure.

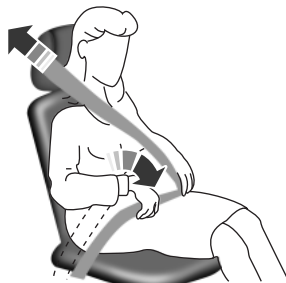

Pregnant women should always wear their safety belts. The lap belt portion of a combination lap and shoulder belt should be positioned low across the hips below the belly and worn as tight as comfort will allow. The shoulder belt should be positioned to cross the middle of the shoulder and the center of the chest.

Safety Belt Locking Modes

WARNING: After any vehicle crash, all safety belts should be checked for proper function.

All safety restraints in the vehicle are combination lap and shoulder belts. The driver safety belt and the optional front and rear center seat safety belt have the first locking mode described below only. All outboard passenger and outboard rear safety belts have both types of locking modes described as follows:

Vehicle Sensitive Mode

This is the normal retractor mode, which allows free shoulder belt length adjustment to your movements and locking in response to vehicle movement. For example, if the driver brakes suddenly or turns a corner sharply, or the vehicle receives an impact of about 5 mph (8 km/h) or more, the combination safety belts will lock to help reduce forward movement of the driver and passengers.

In addition, the retractor is designed to lock if the webbing is pulled out too quickly. If this occurs, let the belt retract slightly and pull webbing out again in a slow and controlled manner.

Automatic Locking Mode

In this mode, the shoulder belt is automatically pre-locked. The belt will still retract to remove any slack in the shoulder belt. The automatic locking mode is not available on the driver safety belt or the optional front or rear center safety belt.

When to Use the Automatic Locking Mode

This mode should be used any time a child safety seat is installed in a front outboard passenger seating position or any outboard rear seating position (if equipped). The optional front and rear seat center safety belt have a cinch mechanism. Children 12 years old and under should be properly restrained in a rear seating position whenever possible. See the *Child Safety* chapter.

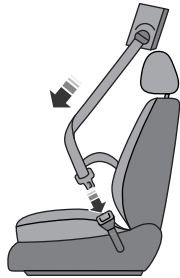
How to Use the Automatic Locking Mode

1. Buckle the combination lap and shoulder belt.
2. Grasp the shoulder portion and pull downward until the entire belt is pulled out.
 - Allow the belt to retract. As the belt retracts, you will hear a clicking sound. This indicates the safety belt is now in the automatic locking mode.

How to Disengage the Automatic Locking Mode

WARNING: After any vehicle crash, the safety belt system at all passenger seating positions must be checked by an authorized dealer to verify that the “automatic locking retractor” feature for child seats is still functioning properly. In addition, all safety belts should be checked for proper function.



WARNING: Belt and retractor assembly must be replaced if the safety belt assembly “automatic locking retractor” feature or any other safety belt function is not operating properly when checked by an authorized dealer. Failure to replace the belt and retractor assembly could increase the risk of injury in crashes.

Unbuckle the combination lap and shoulder belt and allow it to retract completely to disengage the automatic locking mode and activate the vehicle sensitive (emergency) locking mode.



WARNING: Failure to replace the safety belt assembly under the above conditions could result in severe personal injuries in the event of a crash.

Energy Management Feature

- This vehicle has a safety belt system with an energy management feature at the front outboard seating positions to help further reduce the risk of injury in the event of a head-on crash.
- The front outboard safety belt systems have a retractor assembly that is designed to pay out webbing in a controlled manner. This feature is designed to help reduce the belt force acting on the occupant's chest.

Safety Belt Extension Assembly



WARNING: Do not use extensions to change the fit of the shoulder belt across the torso.

If the safety belt is too short when fully extended, you can obtain a safety belt extension assembly from an authorized dealer.

Use only extensions manufactured by the same supplier as the safety belt. Manufacturer identification is located at the end of the webbing on the label. Also, use the safety belt extension only if the safety belt is too short for you when fully extended.

SAFETY BELT HEIGHT ADJUSTMENT



WARNING: Position the safety belt height adjusters so that the belt rests across the middle of your shoulder. Failure to adjust the safety belt properly could reduce the effectiveness of the safety belt and increase the risk of injury in a crash.

Adjust the height of the shoulder belt so the belt rests across the middle of your shoulder.

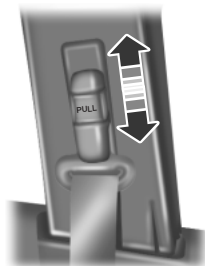

To adjust the shoulder belt height:

1. Pull on the center button and slide the height adjuster up or down.
2. Release the button and pull down on the height adjuster to make sure it is locked in place.

SAFETY BELT WARNING LIGHT AND INDICATOR CHIME

This lamp illuminates and an audible warning sounds if the driver's safety belt has not been fastened when the vehicle's ignition is turned on.

Conditions of Operation

If...	Then...
The driver's safety belt is not buckled before the ignition switch is turned to the on position...	The safety belt warning light illuminates 1-2 minutes and the warning chime sounds 4-8 seconds.
The driver's safety belt is buckled while the indicator light is illuminated and the warning chime is sounding...	The safety belt warning light and warning chime turn off.
The driver's safety belt is buckled before the ignition switch is turned to the on position...	The safety belt warning light and indicator chime remain off.

SAFETY BELT-MINDER®

This feature supplements the safety belt warning function by providing additional reminders by intermittently sounding a chime and illuminating the safety belt warning light when the driver's seat is occupied and the safety belt is unbuckled.

If...	Then...
The driver's safety belt is buckled before the ignition switch is turned to the on position or less than 1-2 minutes have elapsed since the ignition switch has been turned to on...	The Belt-Minder® feature does not activate.
The driver's safety belt is not buckled when the vehicle has reached at least 6 mph (9.7 km/h) and 1-2 minutes have elapsed since the ignition switch has been turned to on...	The Belt-Minder® feature is activated - the safety belt warning light illuminates and the warning chime sounds for six seconds every 25 seconds, repeating for approximately five minutes or until the safety belt is buckled.
The driver's safety belt becomes unbuckled for approximately one minute while the vehicle is traveling at least 6 mph (9.7 km/h) and more than 1-2 minutes have elapsed since the ignition switch has been turned to on...	The Belt-Minder® feature is activated - the safety belt warning light illuminates and the warning chime sounds for six seconds every 25 seconds, repeating for approximately five minutes or until the safety belt is buckled.

Deactivating and Activating the Belt-Minder® Feature

WARNING: While the design allows you to deactivate your Belt-Minder®, this system is designed to improve your chances of being safely belted and surviving an accident. We recommend you leave the Belt-Minder® system activated for yourself and others who may use the vehicle. To reduce the risk of injury, do not deactivate or activate the Belt-Minder® feature while driving the vehicle.

Read Steps 1-4 thoroughly before proceeding with the deactivation or activation programming procedure.

The system can be deactivated and activated by performing the following procedure:

Before following the procedure, make sure that:

- the parking brake is set
 - the gearshift is in position **P** (if equipped) or **N** for an automatic transmission or neutral for a manual transmission
 - the ignition is off
 - all vehicle doors are closed
 - the driver's safety belt is unbuckled
 - the parklamps and headlamps are off.
1. Turn the ignition on. (DO NOT START THE ENGINE.)
 2. Wait until the safety belt warning light turns off (approximately one or two minutes).
 - Steps 3–5 must be completed within 60 seconds after the safety belt warning light turns off, or the procedure has to be repeated.
 3. Buckle then unbuckle the safety belt three times at a moderate speed, ending with the safety belt in the unbuckled state.
 4. Turn on the parklamps and headlamps, then turn them off.
 5. Buckle then unbuckle the safety belt three times at a moderate speed, ending with the safety belt in the unbuckled state.
 - After Step 5, the safety belt warning light turns on for three seconds.
 6. Within seven seconds of the light turning on, buckle then unbuckle the safety belt.
 - This disables the Belt-Minder® feature if it is currently enabled.
 - This enables the Belt-Minder® feature if it is currently disabled.

Confirmation of disabling Belt-Minder® is provided by the safety belt warning light flashing four times per second for three seconds.

Confirmation of enabling Belt-Minder® is provided by:

- the safety belt warning light flashing four times per second for three seconds
- the safety belt warning light turning off
- the safety belt warning light flashing four times per second for three seconds.

After receiving confirmation, the procedure is complete.

CHILD RESTRAINT AND SAFETY BELT MAINTENANCE

Inspect the vehicle safety belts and child safety seat systems periodically to make sure they work properly and are not damaged. Inspect the vehicle and child seat safety belts to make sure there are no nicks, tears or cuts. Replace if necessary. All vehicle safety belt assemblies, including retractors, buckles, front safety belt buckle assemblies, buckle support assemblies (slide bar-if equipped), shoulder belt height adjusters (if equipped), shoulder belt guide on seat back (if equipped), child safety seat LATCH and tether anchors, and attaching hardware, should be inspected after a crash. Read the child restraint manufacturer's instructions for additional inspection and maintenance information specific to the child restraint. Ford Motor Company recommends that all safety belt assemblies in use in vehicles involved in a crash be replaced. However, if the crash was minor and an authorized dealer finds that the belts do not show damage and continue to operate properly, they do not need to be replaced. Safety belt assemblies not in use during a crash should also be inspected and replaced if either damage or improper operation is noted.

For proper care of soiled safety belts, see *Cleaning the interior* in the *Vehicle Care* chapter.

KEYS

The key operates all locks on your vehicle. In case of loss, replacement keys are available from your dealer.

You should always carry a second key with you in a safe place in case you require it in an emergency.

LOCKING AND UNLOCKING

You can use the power door lock control to lock and unlock the vehicle.

Power Door Locks (If Equipped)

The power door lock control is located on the driver and front passenger door panels.

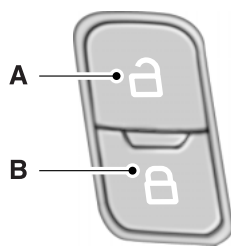

A. Unlock

B. Lock

ADJUSTING THE STEERING WHEEL

WARNING: Do not adjust the steering wheel when your vehicle is moving.

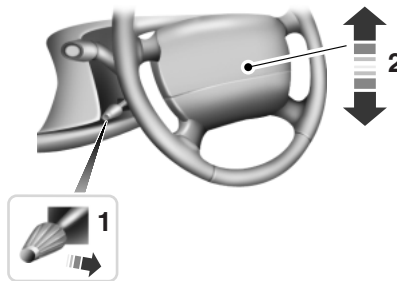

1. Pull and hold the steering wheel release lever.
2. Adjust the steering wheel to the desired position then release the lever.

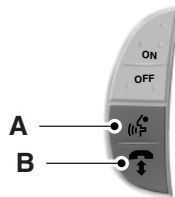
VOICE CONTROL (IF EQUIPPED)

- A. Voice recognition
- B. Phone mode

See the *SYNC* chapter.

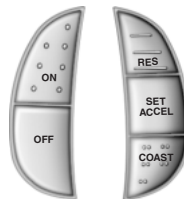
CRUISE CONTROL (IF EQUIPPED)

See the *Cruise Control* chapter.

WINDSHIELD WIPERS

Note: Fully defrost the windshield in icy conditions before turning on the windshield wipers.

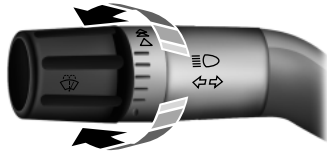

Rotate the end of the control away from you to increase the speed of the wipers. Rotate toward you to decrease the speed of the wipers.

WINDSHIELD WASHERS

Note: Do not operate the wipers on a dry windshield. This may scratch the glass, damage the wiper blades or cause the wiper motor to burn out. Always use the windshield washer before wiping a dry windshield.

Note: Do not operate the washers when the washer reservoir is empty. This may cause the washer pump to overheat.

Press the end of the stalk to activate the washer.

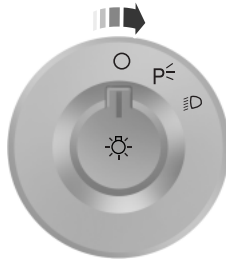

- A brief press causes a single wipe without washer fluid.
- A quick press and hold causes the wipers to swipe three times with washer fluid.
- A long press and hold will activate the wipers and washer fluid for up to 10 seconds.

LIGHTING CONTROL

- Rotate the headlamp control clockwise to the first position to turn on the parking lamps.
- Rotate clockwise to the second position to also turn on the headlamps.

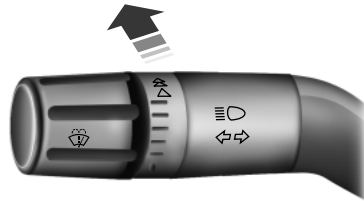
High Beams

- Push the lever toward the instrument panel to activate.
- Pull the lever toward you to deactivate.

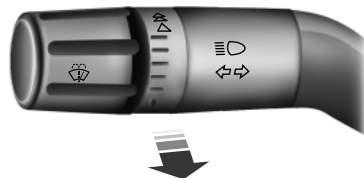
Headlamp Flasher

Pull toward you slightly to activate and release to deactivate.

INSTRUMENT LIGHTING DIMMER

Use to adjust the brightness of the instrument panel and all applicable lit components in the vehicle during headlamp and parking lamp operation.



- Tap the top or bottom of the control to brighten or dim all interior lit components incrementally, or
- press and hold at the first position the top or bottom of the control until the desired lighting level is reached.

DAYTIME RUNNING LAMPS (DRL) (IF EQUIPPED)

WARNING: Always remember to switch your headlamps on in low light situations or during inclement weather. The system does not activate the tail lamps and may not provide adequate lighting during these conditions. Failure to activate your headlamps under these conditions may result in a crash.

The system switches the headlamps on with a reduced output in daylight conditions.

To switch the system on:

1. Switch the ignition on.
2. Switch the lighting control to the off or parking lamp position.

DIRECTION INDICATORS

- Push down to activate the left turn signal.
- Push up to activate the right turn signal.

If your vehicle is a tractor, the turn signals may not shut off when a turn is completed. This is normal. See your dealer if there are any questions about your vehicle's options.

INTERIOR LAMPS

The map lamps are located on the overhead console.



Press the controls on either side of each map lamp to turn on the lamps.

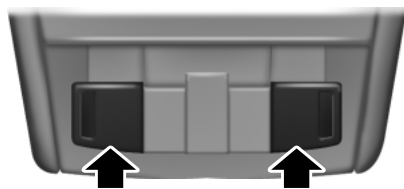

The map lamps also light when:

- Any door is opened.
- Any of the remote entry controls are pressed and the ignition is off.

POWER WINDOWS (IF EQUIPPED)

 **WARNING:** Do not leave children unattended in your vehicle and do not let them play with the power windows. They may seriously injure themselves.

 **WARNING:** When closing the power windows, you should verify they are free of obstructions and make sure that children and pets are not in the proximity of the window openings.

Note: You may hear a rumbling noise when one or both of the rear windows are open. Lower a front window slightly to reduce this noise.

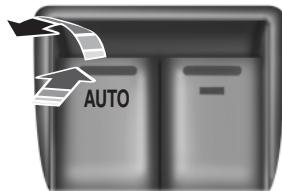

Press the switch to open the window.

Lift the switch to close the window.

One-Touch Up or Down (Front Windows)

Note: The window may be disabled for up to five minutes if it is cycled up and down repeatedly. This helps prevent damage to the motor. Normal operation will resume once the motor cools.

This feature automatically opens or closes the window.

Press or lift the switch completely and release. The window will fully open or close. Press or lift it again to stop the window.

Restoring the One-Touch Up Functionality

Note: Perform one-touch up re-calibration with the door closed. Calibrating with the door open will cause the window to continuously bounce back.

Functionality may be lost under low battery power conditions.

To reset this function after restoring full battery power:

1. Pull the switch to the one-touch up position.
2. Hold the switch until the glass reaches the stall position and continue to hold for two seconds.
3. Press the switch down and operate the window to the full down position. One-touch up will now be functional.

Bounce-Back (One-Touch Up or Down Windows Only)

The window will stop automatically while closing and reverse some distance if there is an obstacle in the way.

Overriding the Bounce-Back Feature

WARNING: When you override the bounce-back feature the window will not reverse if it detects an obstacle. Take care when closing the windows to avoid personal injury or damage to your vehicle.

Pull up the window switch and hold within two seconds of the window reaching the bounce-back position. The window will travel up with no bounce-back protection. The window will stop if you release the switch before the window is fully closed.

Window Lock

This feature allows only the driver and front passenger to operate the power windows.

To lock the window controls, press the switch. A light on the switch illuminates when the windows are locked. Press the switch again to restore the window controls.

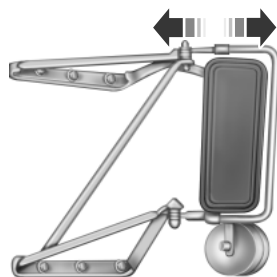
EXTERIOR MIRRORS

With the doors closed and the seat adjusted for proper comfort, move the mirrors to maximize rear viewing area by adjusting the mirrors left or right as required.

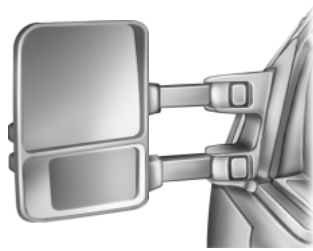

Adjust the auxiliary convex mirrors.



Convex mirrors are a ball-stud design for precise adjustment to maximize viewing area.

Power Exterior Mirrors (If Equipped)



WARNING: Do not adjust the mirror while the vehicle is in motion.

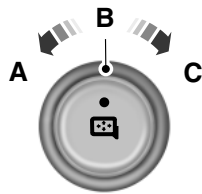

- A. Left-hand mirror
- B. Off
- C. Right-hand mirror

To adjust your mirrors:

1. Select the mirror you want to adjust.
2. Move the control in the direction you want to tilt the mirror.
3. Return the control to the center position to lock mirrors in place.

The spotter mirror (if equipped) must be adjusted manually.

Fold-Away Exterior Mirrors

Push the mirror toward the door window glass. Make sure that you fully engage the mirror in its support when returning it to its original position.

Power-Folding Mirrors (If Equipped)

Note: Activating the mirrors 10 or more times within one minute, or repeated folding and unfolding of the mirrors while holding the control down during full travel, may disable the system to protect motors from overheating. Wait approximately three minutes with the vehicle running, and up to 10 minutes with the vehicle off, for the system to reset and for function to return to normal.



Pull the control back to fold the mirrors in or out.

Loose Mirror

A power-folding mirror may also be manually folded by pulling it toward the door window glass. This may cause the mirror to appear loose and it will need to be re-synchronized. Pull and hold the control to fold the mirrors in until movement stops. A click will be heard indicating re-synchronization. If the click is not heard, use the control to fold the mirrors all the way out, then in again. Once the click is heard the mirrors will operate normally until they are again manually folded.

Heated Exterior Mirror (If Equipped)

The heated exterior mirrors switch on with the heated mirror switch. See *Heated mirrors* in the *Climate Control* chapter.

Signal Indicator Mirrors (If Equipped)

The outer portion of the appropriate mirror housing blinks when you activate the turn signal.

Clearance Lamps (If Equipped)

The lower, outer portion of the mirror housings illuminates when the headlamps or parking lamps are switched on.

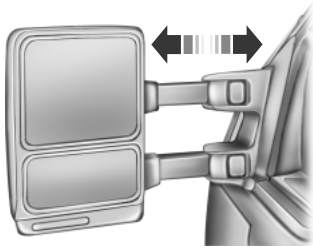
Telescoping Mirrors (If Equipped)

This feature allows the mirror to extend approximately 3 inches (75 millimeters). It is especially useful when towing a trailer. The mirrors can be manually pulled out or pushed in to the desired position.

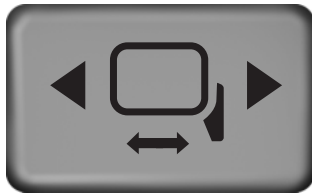
PowerScope® Power Telescoping Mirrors (If Equipped)

This feature lets you position both mirrors at the same time. The switch is on the door trim panel.

To telescope the mirrors out, press and hold the left side of the switch. When the mirrors are fully extended, it is normal to hear the telescoping motors running as long as you continue to hold the switch.

To telescope the mirrors in, press and hold the right side of the switch.

GAUGES - DIESEL ENGINE

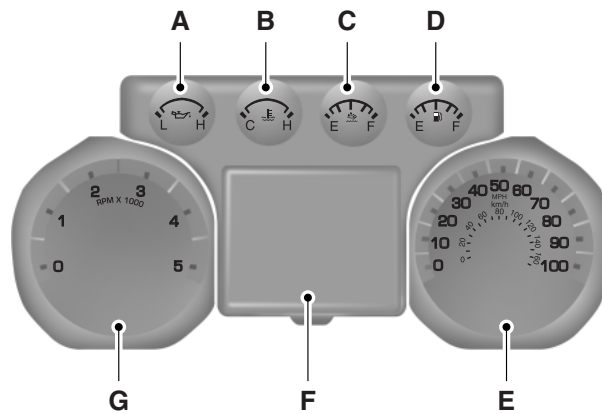

Cluster shown in standard measure. Metric similar.

A. Engine oil pressure gauge

B. Engine coolant temperature gauge

C. Diesel exhaust fluid (DEF) gauge

D. Fuel gauge

E. Speedometer

F. Information display. See the *Information Displays* chapter for more information.

G. Tachometer

Engine Oil Pressure Gauge

Indicates engine oil pressure. The needle should stay in the normal operating range. If the needle falls below the normal range, stop the vehicle, turn off the engine and check the engine oil level. Add oil if needed. If the oil level is correct, have your vehicle checked at your authorized dealer.

Engine Coolant Temperature Gauge

Indicates engine coolant temperature. At normal operating temperature, the level indicator is in the normal range. If the engine coolant temperature exceeds the normal range, stop the vehicle as soon as safely possible, switch off the engine and let the engine cool.



WARNING: Never remove the coolant reservoir cap while the engine is running or hot.

Diesel Exhaust Fluid (DEF) Gauge

Indicates fluid level in DEF tank.

Fuel Gauge

Indicates approximately how much fuel is left in the fuel tank (when the ignition is on). The fuel gauge may vary slightly when the vehicle is in motion or on a grade. The fuel icon and arrow indicates which side of the vehicle the fuel filler door is located.

Information Display

Odometer: Located in the bottom of the information display. Registers the accumulated distance your vehicle has travelled.

Trip Computer: See *General information* in the *Information Displays* chapter.

Vehicle Settings and Personalization: See *General information* in the *Information Displays* chapter.

GAUGES - GASOLINE ENGINE

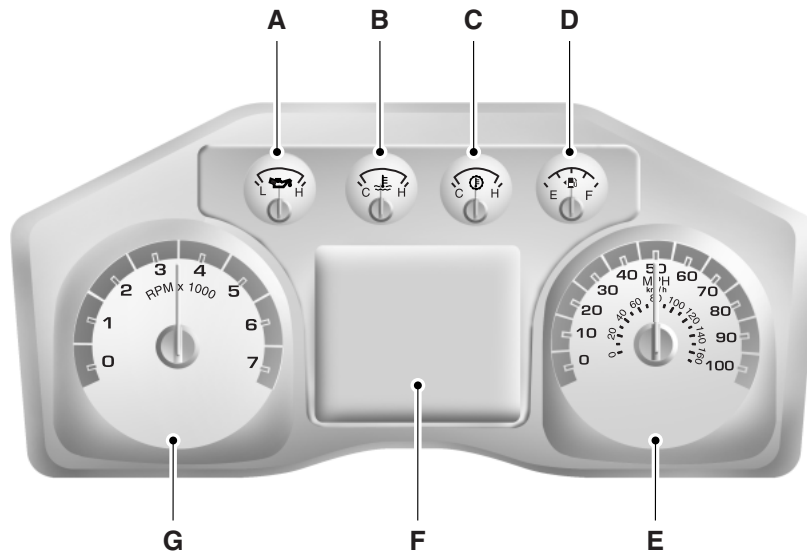

Cluster shown in standard measure. Metric similar.

A. Engine oil pressure gauge

B. Engine coolant temperature gauge

C. Transmission fluid temperature gauge

D. Fuel gauge

E. Speedometer

F. Information display. See the *Information Displays* chapter for more information.

G. Tachometer

Engine Oil Pressure Gauge

Indicates engine oil pressure. The needle should stay in the normal operating range. If the needle falls below the normal range, stop the vehicle, turn off the engine and check the engine oil level. Add oil if needed. If the oil level is correct, have your vehicle checked at your authorized dealer.

Engine Coolant Temperature Gauge

Indicates engine coolant temperature. At normal operating temperature, the level indicator is in the normal range. If the engine coolant temperature exceeds the normal range, stop the vehicle as soon as safely possible, switch off the engine and let the engine cool.



WARNING: Never remove the coolant reservoir cap while the engine is running or hot.

Transmission Fluid Temperature Gauge

Indicates transmission fluid temperature. At normal operating temperature, the level indicator is in the normal range. If the transmission fluid temperature exceeds the normal range, stop the vehicle as soon as safely possible and verify the airflow is not restricted, such as snow or debris blocking airflow through the grill. Also, higher than normal operating temperature can be caused by special operation conditions (i.e., snowplowing, towing or off-road use). Operating the transmission for extended periods of time with the gauge in the higher than normal area may cause internal transmission damage. Altering the severity of the driving conditions is recommended to lower the transmission temperature into the normal range. If the gauge continues to show high temperatures, see your authorized dealer.

Fuel Gauge

Indicates approximately how much fuel is left in the fuel tank (when the ignition is on). The fuel gauge may vary slightly when the vehicle is in motion or on a grade. The fuel icon and arrow indicates which side of the vehicle the fuel filler door is located.

Information Display

Odometer: Located in the bottom of the information display. Registers the accumulated distance your vehicle has travelled.

Trip Computer: See *General information* in the *Information Displays* chapter.

Vehicle Settings and Personalization: See *General information* in the *Information Displays* chapter.

Gauge Package (If Equipped)

Your vehicle may be equipped with an optional gauge package which has one of the following configurations:



1. **Transmission temperature gauge:** Displays the transmission temperature at the transmission sump.
2. **Hourmeter:** Displays the hours of engine run time.
3. **Voltmeter:** Displays electrical system voltage.

WARNING LAMPS AND INDICATORS

The following warning lamps and indicators alert you to a vehicle condition that may become serious. Some lamps illuminate when you start your vehicle to make sure they work. If any lamps remain on after starting your vehicle, see the respective system warning lamp for further information.

Note: Some warning indicators appear in the information display and function the same as a warning lamp but do not display when you start your vehicle.

Anti-Lock Braking System

If it illuminates when you are driving, this indicates a malfunction. You continue to have the normal braking system (without ABS) unless the brake warning lamp is also illuminated. Have the system checked by your authorized dealer.

Brake System

To confirm the brake system warning light is functional, it momentarily illuminates when the ignition is turned to the on position when the engine is not running, or in a position between on and start.

If the brake system warning light does not illuminate at this time, seek service immediately from your authorized dealer.



WARNING: Driving a vehicle with the brake system warning light on is dangerous. A significant decrease in braking performance may occur. It takes you longer to stop the vehicle. Have the vehicle checked by your authorized dealer. Driving extended distances with the parking brake engaged can cause brake failure and the risk of personal injury.

Charging System



It illuminates when the 12-volt battery is not charging properly. Contact your authorized dealer as soon as possible. This indicates a problem with the electrical system or a related component.

Check Fuel Cap (gasoline engine only)



It illuminates when the fuel cap may not be properly installed. Continued driving with this light on may cause the service engine soon warning indicator to come on.

Check Suspension



It illuminates when the air suspension dump switch has been activated.

Check Transmission (Allison automatic transmission only)



It illuminates while driving if a problem has been detected in the transmission; shifting may be restricted. Depending on the severity of the problem, the shifter's digital read-out may turn blank.

On MD 3000 series transmissions, operation may continue in order to reach service assistance. The control unit may not respond to shift selector requests, since operating limitations are being placed on the transmission (i.e. upshifts and downshifts may be restricted). Direction changes do not occur.

Cruise Control



It illuminates when you switch this feature on.

Diesel Exhaust Fluid (diesel engine only)

It illuminates when the diesel exhaust fluid level falls below 0.5 gallons (1.9L) in the five gallon (19.0L) tank or one gallon (3.8L) in the nine gallon (34.0L) tank. Refill the tank or, at a minimum, add at least one gallon (3.8L) to the five gallon (19.0L) tank or two gallons (7.6L) to the nine gallon (34.0L) tank.

Diesel Particulate Filter (diesel engine only)

It illuminates when the soot level in the diesel particulate filter has reached a point where it requires operator assistance. See *Diesel particulate filter* in the *Maintenance* chapter, and your engine operator's manual, for more details.

Do Not Shift (Allison automatic transmission only)

It illuminates while driving if a problem has been detected in the transmission; shifting may be restricted. Depending on the severity of the problem, the shifter's digital read-out may turn blank.

Operation may continue in order to reach service assistance. The control unit may not respond to shift selector requests, since operating limitations are being placed on the transmission (i.e. upshifts and downshifts may be restricted). Direction changes do not occur.

Direction Indicator

It illuminates when the left or right turn signal or the hazard warning flasher is switched on. If the indicators stay on or flash faster, check for a burned out bulb.

Electronic Locking Differential

It illuminates when using the electronic locking differential.

Engine Oil Pressure (gasoline engine only)

It illuminates when engine oil pressure is low.

Fasten Safety belt

It illuminates and a chime sounds to remind you to fasten your safety belt.

High Beam

It illuminates when the headlamp high beam is switched on.

Low Fuel Level (gasoline engine only)

It illuminates when the fuel level is low or near empty. Refuel as soon as possible.

Parking Brake Warning

It momentarily illuminates when the ignition is switched to the on position (with the engine off). It also illuminates when the parking brake is engaged. If the parking brake warning lamp does not illuminate at these times, seek service immediately.

Vehicles equipped with the Power Park Parking Brake option: If the park brake warning lamp begins to blink after setting the parking brake on your vehicle, this may indicate a failure in the parking brake system. Seek service from your dealer immediately.

Powertrain Malfunction/Reduced Power/Electronic Throttle Control (gasoline engine only)

It illuminates when a powertrain fault has been detected. Contact your authorized dealer as soon as possible.

Service Engine Soon

It illuminates when the ignition is first switched to the on position to check the bulb and to indicate whether the vehicle is ready for Inspection/Maintenance (I/M) testing.

Solid illumination after the engine is started indicates the on-board diagnostics system (OBD-II) has detected a malfunction.



WARNING: Under engine misfire conditions, excessive exhaust temperatures could damage the catalytic converter, the fuel system, interior floor coverings or other vehicle components, possibly causing a fire.

Stop Engine (diesel engine only)

This red lamp illuminates when the engine needs to be stopped (as soon as it can be safely done). If the lamp begins flashing, automatic engine shutdown may take place in as little as 20 seconds.



WARNING: In the event of engine shutdown, make sure the vehicle is safely off the road and the problem is remedied prior to returning to the road. Failure to remove the vehicle from the road could result in an accident, causing serious injury or death.

If the engine shuts down, it can be restarted and operated for 30 seconds at a time, or until the problem is corrected. For more information, see *Engine automatic shutdown warning light or chime* in the *Driving* chapter, and your engine operator's manual.

See your engine operator's manual for specific information regarding this feature. Drivers of electronically-controlled engines should know the extent of the warning engine shutdown system before operating the vehicle.

Traction Control (diesel engine only)

It illuminates and flashes slowly if the Off Road or Mud/Snow mode is selected. It illuminates and flashes rapidly during a traction control event.

Trailer Anti-Lock Braking System (ABS)

It illuminates briefly when the ignition is switched on and only when a PLC trailer or a PLC diagnostic tool is connected. If the light fails to illuminate, remains on after the vehicle is started or continues to flash, have the system serviced immediately.

Wait to Start (diesel engine only)

It illuminates when the air intake heater is in operation and special starting procedures are required.



WARNING: If equipped with an air intake heater, DO NOT use ether or any other starting fluids. The use of starting fluids (ether) in an engine equipped with an air intake heater could result in damage and/or personal injury.

Water in Fuel (diesel engine only)

It illuminates when the fuel filter/water separator has a significant quantity of water in it.

If the light illuminates when the engine is running, stop the vehicle as soon as safely possible, shut off the engine, then drain the fuel filter/water separator. See your engine operator's manual for the drain procedure. Allowing water to stay in the system could result in extensive damage to, or failure of, the fuel injection system.



WARNING: Do not drain the water separator while the engine is running. Fuel may ignite if the separator is drained while the engine is running or the vehicle is moving.

AUDIBLE WARNINGS AND INDICATORS**Key In Ignition Warning Chime**

Sounds when the key is left in the ignition in the off or accessory position and the driver's door is opened.

Sounds when the keyless vehicle is in RUN and the driver's door is opened (if equipped).

Headlamps On Warning Chime

Sounds when the headlamps or parking lamps are on, the ignition is off (the key is not in the ignition) and the driver's door is opened.

GENERAL INFORMATION

WARNING: Driving while distracted can result in loss of vehicle control, accident and injury. Ford strongly recommends that drivers use extreme caution when using any device or feature that may take their focus off the road. Your primary responsibility is the safe operation of the vehicle. We recommend against the use of any handheld device while driving and that you comply with all applicable laws.

Various systems on your vehicle can be controlled using the information display controls on the steering wheel. Corresponding information is displayed in the information display.

Information Display Controls

- Press the INFO button to scroll through trip and fuel usage information.
- Press the SETUP button to scroll through various vehicle feature settings.
- Press the RESET button to choose settings, reset information and confirm messages.

Info

Press the INFO button repeatedly to cycle through the following features:

Note: Some options may appear slightly different or not at all if the items are optional.

INFO
TRIP A/B
MILES (km) TO E
AVG MPG (L/100 km)
TIMER
BLANK SCREEN

- **TRIP A/B:** Registers the distance of individual journeys. Press and release the INFO button until the A or B trip appears in the display (this represents the trip mode). Press the RESET button to reset. See *System check and vehicle feature customization* later in this section to switch the display from metric to English.
- **MILES (KILOMETERS) TO E:** This displays an estimate of approximately how far you can drive with the fuel remaining in your tank under normal driving conditions. Remember to turn the ignition off when refueling to allow this feature to correctly detect the added fuel. Distance to empty is calculated using a running average fuel economy, which is based on your recent driving history of 500 miles (800 kilometers). This value is not the same as the average fuel economy display. The running average fuel economy is re-initialized to a factory default value if the battery is disconnected.
- **AVG MPG (L/100 km):** Average fuel economy displays your average fuel economy in miles/gallon or liters/100 km.
- **TIMER:** Displays the trip elapsed drive time. Press and release RESET to pause the timer. Press and hold RESET to reset the timer.

System Check and Vehicle Feature Customization



Press the SETUP button repeatedly to cycle the message center through the following features:

SETUP		
RESET FOR SYSTEM CHECK	Press the RESET button.	OIL LIFE
		CHARGING SYSTEM
		BRAKE SYSTEM
		MILES TO EMPTY
UNITS	Press the RESET button.	English or Metric
LANGUAGE = ENGLISH / SPANISH / FRENCH	Press the RESET button.	English / Spanish / French (Press and hold to set.)

INFORMATION MESSAGES

Note: Depending on the vehicle options equipped with your vehicle, not all of the messages display or are available. Certain messages may be abbreviated or shortened depending upon which cluster type you have.

Press the OK button to acknowledge and remove some messages from the information display. Other messages are removed automatically after a short time. Certain messages need to be confirmed before you can access the menus.

Battery and Charging System Messages	Action / Description
CHECK CHARGING SYSTEM	Displayed when the charging system needs servicing. If the warning stays on or continues to come on, contact your authorized dealer as soon as possible.
Brake System Messages	Action / Description
BRAKE FLUID LEVEL LOW	Displayed when the brake fluid level is low and the brake system should be inspected immediately. See <i>Brake fluid check</i> in the <i>Maintenance</i> chapter.
CHECK BRAKE SYSTEM	Displayed when the brake system needs servicing. If the warning stays on or continues to come on, contact your authorized dealer as soon as possible.
PARK BRAKE ENGAGED	Displayed when the parking brake is set and the vehicle is in motion.

GENERAL INFORMATION

Radio Frequencies and Reception Factors

AM and FM frequencies are established by the Federal Communications Commission (FCC) and the Canadian Radio and Telecommunications Commission (CRTC). Those frequencies are:

AM: 530, 540–1700, 1710 kHz

FM: 87.9–107.7, 107.9 MHz

Radio reception factors	
Distance and strength	The further you travel from an FM station, the weaker the signal and the weaker the reception.
Terrain	Hills, mountains, tall buildings, bridges, tunnels, freeway overpasses, parking garages, dense tree foliage and thunderstorms can interfere with the reception.
Station overload	When you pass a ground-based broadcast repeating tower, a stronger signal may overtake a weaker one and result in the audio system muting.

CD and CD Player Information

Note: CD units play commercially pressed 4.75-inch (12 centimeter) audio compact discs only. Due to technical incompatibility, certain recordable and re-recordable compact discs may not function correctly when used in Ford CD players.

Note: Do not insert CDs with homemade paper (adhesive) labels into the CD player as the label may peel and cause the CD to become jammed. You should use a permanent felt tip marker rather than adhesive labels on your homemade CDs. Ballpoint pens may damage CDs. Please contact your authorized dealer for further information.

Note: Do not use any irregularly shaped discs or discs with a scratch protection film attached.

Always handle discs by their edges only. Clean the disc with an approved CD cleaner only. Wipe it from the center of the disc toward the edge. Do not clean in a circular motion.

Do not expose discs to direct sunlight or heat sources for extended periods.

MP3 Track and Folder Structure

Audio systems capable of recognizing and playing MP3 individual tracks and folder structures work as follows:

- There are two different modes for MP3 disc playback: MP3 track mode (system default) and MP3 folder mode.
- MP3 track mode ignores any folder structure on the MP3 disc. The player numbers each MP3 track on the disc (noted by the .mp3 file extension) from T001 to a maximum of T255. **Note:** The maximum number of playable MP3 files may be less depending on the structure of the CD and exact model of radio present.
- MP3 folder mode represents a folder structure consisting of one level of folders. The CD player numbers all MP3 tracks on the disc (noted by the .mp3 file extension) and all folders containing MP3 files, from F001 (folder) T001 (track) to F253 T255.
- Creating discs with only one level of folders helps with navigation through the disc files.

If you are burning your own MP3 discs, it is important to understand how the system reads the structures you create. While various files may be present, (files with extensions other than mp3), only files with the .mp3 extension are played; other files are ignored by the system. This enables you to use the same MP3 disc for a variety of tasks on your work computer, home computer and your in-vehicle system.

In track mode, the system displays and plays the structure as if it were only one level deep (all .mp3 files play, regardless of being in a specific folder). In folder mode, the system only plays the .mp3 files in the current folder.

AM/FM

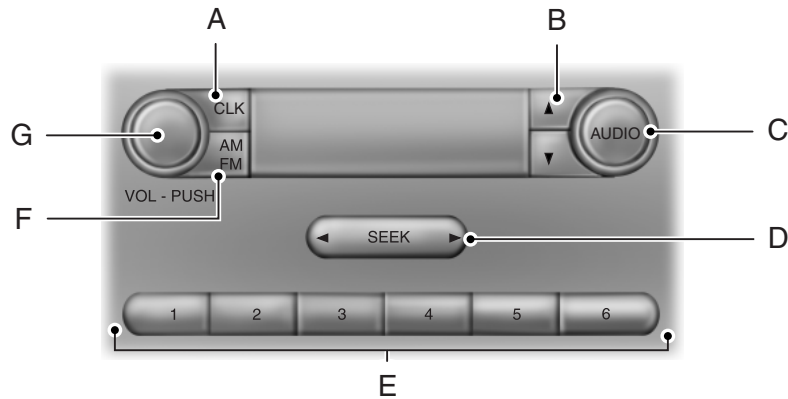

! **WARNING:** Driving while distracted can result in loss of vehicle control, crash and injury. We strongly recommend that you use extreme caution when using any device that may take your focus off the road. Your primary responsibility is the safe operation of your vehicle. We recommend against the use of any hand-held device while driving and encourage the use of voice-operated systems when possible. Make sure you are aware of all applicable local laws that may affect the use of electronic devices while driving.

- A. **CLK:** Press this button to switch the display between the clock and radio frequency. To set the time:
 1. Press and hold **CLK** until the hours start to flash.
 2. Press the arrow buttons to adjust the hours. Repeat Steps 1 and 2 to set the minutes.
 3. Press **CLK** again to exit clock mode.
- B. **Tune:** Press these arrow buttons to manually search through the radio frequency band. Press and hold for a fast search. In **AUDIO** mode, press the buttons to adjust different sound settings.
- C. **AUDIO:** Press this button to access settings for Treble, Middle, Bass, Fade and Balance.
- D. **SEEK:** Press this button to go to the previous or next strong station on the frequency band.

E. **Memory presets:** Store your favorite radio stations. To store a radio station, tune to the station, then press and hold a preset button until sound returns.

F. **AM/FM:** Press this button to select a frequency band.

G. **VOL-PUSH:**

- Press this button to switch the system off and on.
- Turn the control to adjust the volume.

AM/FM/CD WITH SYNC®

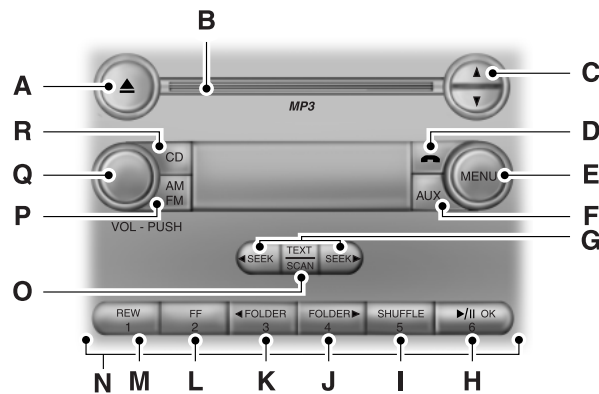

WARNING: Driving while distracted can result in loss of vehicle control, crash and injury. We strongly recommend that you use extreme caution when using any device that may take your focus off the road. Your primary responsibility is the safe operation of your vehicle. We recommend against the use of any hand-held device while driving and encourage the use of voice-operated systems when possible. Make sure you are aware of all applicable local laws that may affect the use of electronic devices while driving.

A. **Eject:** Press this button to eject a CD.

B. **CD slot:** Insert a CD.

C. **Tune:** Press this button to manually search through the radio frequency band. Press and hold for a fast search.

D. **Phone:** Press this button to access the phone features of the SYNC® system. See the *SYNC®* chapter for more information.

E. **MENU:** Press this button to access different audio system features.

- If your vehicle is equipped with satellite radio, you can access different menus by pressing **OK**.
- Set the time by pressing **MENU** until **SET HOURS** or **SET MINUTES** appears and using the arrow buttons to adjust the time.
- Set the strongest stations on the radio frequency by pressing **MENU** until **AUTOSET** appears. **AUTOSET** does not override your original presets.
- **RBDS** displays text transmitted by certain radio stations and searches for music categories. To search for music categories, turn on RBDS (by using the **SEEK** buttons when **RBDS ON/OFF** appears). Press the up and down arrow buttons to scroll through categories, then use the **SEEK** buttons to begin the search.
- **SPEEDVOL** (speed compensated volume) allows you to adjust radio volume to compensate for noise levels when vehicle speed increases.
- **Track/Folder** is only available on MP3 files when in CD mode. In track mode, pressing the **SEEK** arrows allows you to scroll through all the tracks on the disc. In folder mode, pressing the **SEEK** arrows allows you to scroll through all the tracks within the selected folder. Press the **FOLDER** buttons to access other folders.
- **COMPRESS** (Compression) is only available in CD and MP3 modes. Switching compression on brings the soft and loud passages together for a more consistent listening level. Use the **SEEK** buttons and up and down arrow buttons to switch it on and off.

F. **AUX:** Press this button to access the media features of the SYNC® system. See the *SYNC®* chapter for more information.

G. **SEEK:**

- In radio mode, press and release these buttons to go to the next (or previous) preset radio station or disc track.
- In CD and MP3 modes, press these buttons to select the next (or previous) track, or press and hold to advance (or reverse) within the same track.

H. **Play, Pause and OK:**

- Play and Pause allow you to play or pause a track when listening to a CD.
- **OK** allows you to confirm commands with phone and media features of the SYNC system. See the *SYNC®* chapter for more information.

I. **SHUFFLE:** Play music on the selected CD or MP3 folder in random order.

J. **Folder:** Press this button to access the next folder on an MP3 disc.

K. **Folder:** Press this button to access the previous folder on an MP3 disc.

L. **FF:** Press this button to manually fast forward in a CD track or MP3 file.

M. **REW:** Press this button to manually rewind in a CD track or MP3 file.

N. **Memory presets:** Store your favorite radio stations. To store a radio station, tune to the station, then press and hold a preset button until sound returns.

O. **TEXT/SCAN:**

- In radio, CD and MP3 modes, press and hold to hear a brief sampling of radio stations, CD tracks or MP3 files.
- In CD and MP3 modes, press and release to display track title, artist name and disc title.

Note: In text mode, sometimes the display requires additional text to show. When the < / > indicator is on, press TEXT and then use the SEEK buttons to view the additional display text.

P. **AM/FM:** Press this button to select a frequency band.

Q. **VOL-PUSH:**

- Press this button to switch the system off and on.
- Turn it to adjust the volume.

R. **CD:** Press this button to enter CD or MP3 mode.

AUXILIARY INPUT JACK



WARNING: Driving while distracted can result in loss of vehicle control, crash and injury. We strongly recommend that you use extreme caution when using any device that may take your focus off the road. Your primary responsibility is the safe operation of your vehicle. We recommend against the use of any hand-held device while driving and encourage the use of voice-operated systems when possible. Make sure you are aware of all applicable local laws that may affect the use of electronic devices while driving.



WARNING: For safety reasons, do not connect or adjust the settings on your portable music player while your vehicle is moving.



WARNING: Store the portable music player in a secure location, such as the center console or the glove box, when your vehicle is moving. Hard objects may become projectiles in a crash or sudden stop, which may increase the risk of serious injury. The audio extension cable must be long enough to allow the portable music player to be safely stored while your vehicle is moving.



The auxiliary input jack allows you to connect and play music from your portable music player through your vehicle speakers. You can use any portable music player designed for use with headphones. Your audio extension cable must have male 1/8-inch (3.5 millimeter) connectors at each end.

1. Switch off the engine, radio and portable music player. Set the parking brake and put the transmission in position **P**.
2. Plug the extension cable from the portable music player into the auxiliary input jack.
3. Switch the radio on. Select either a tuned FM station or a CD.
4. Adjust the volume as desired.
5. Switch your portable music player on and adjust its volume to half its maximum level.
6. Press **AUX** until **LINE** or **LINE IN** appears in the display. You should hear music from your device even if it is low.
7. Adjust the volume on your portable music player until it reaches the volume level of the FM station or CD. Do this by switching back and forth between the AUX and FM or CD controls.

USB PORT (IF EQUIPPED)

WARNING: Driving while distracted can result in loss of vehicle control, crash and injury. We strongly recommend that you use extreme caution when using any device that may take your focus off the road. Your primary responsibility is the safe operation of your vehicle. We recommend against the use of any hand-held device while driving and encourage the use of voice-operated systems when possible. Make sure you are aware of all applicable local laws that may affect the use of electronic devices while driving.



The USB port allows you to plug in media playing devices, memory sticks and charge devices (if supported). See the *SYNC* chapter for more information.

SATELLITE RADIO INFORMATION (IF EQUIPPED)**Satellite Radio Channels**

Sirius broadcasts a variety of music, news, sports, weather, traffic and entertainment satellite radio channels. For more information and a complete list of Sirius satellite radio channels, visit www.siriusxm.com in the United States, www.sirius.ca in Canada, or call Sirius at 1-888-539-7474.

Note: This receiver includes the eCos real-time operating system. eCos is published under the eCos License.

Satellite Radio Reception Factors

Potential satellite radio reception issues	
Antenna obstructions	For optimal reception performance, keep the antenna clear of snow and ice build-up and keep luggage and other material as far away from the antenna as possible.
Terrain	Hills, mountains, tall buildings, bridges, tunnels, freeway overpasses, parking garages, dense tree foliage and thunderstorms can interfere with your reception.
Station overload	When you pass a ground-based broadcast-repeating tower, a stronger signal may overtake a weaker one and the audio system may mute.
Satellite radio signal interference	Your display may show ACQUIRING . . . to indicate the interference and the audio system may mute.

Sirius Satellite Radio Service

Note: Sirius reserves the unrestricted right to change, rearrange, add or delete programming including canceling, moving or adding particular channels, and its prices, at any time, with or without notice to you. Ford Motor Company shall not be responsible for any such programming changes.



Sirius satellite radio is a subscription-based satellite radio service that broadcasts a variety of music, sports, news, weather, traffic and entertainment programming. Your factory-installed Sirius satellite radio system includes hardware and

a limited subscription term which begins on the date of sale or lease of your vehicle. See an authorized dealer for availability.

For more information on extended subscription terms (a service fee is required), the online media player and a complete list of Sirius satellite radio channels, and other features, please visit www.siriusxm.com in the United States, www.sirius.ca in Canada, or call Sirius at 1-888-539-7474.

Satellite Radio Electronic Serial Number (ESN)

You need your ESN to activate, modify or track your satellite radio account. When in satellite radio mode, you can view this number by pressing **SIRIUS** and memory preset 1 at the same time. To access your ESN, press the bottom left corner of the touchscreen, then **SIRIUS > Options**.

Troubleshooting

Radio display	Condition	Possible action
Acquiring	Radio requires more than two seconds to produce audio for the selected channel.	No action required. This message should disappear shortly.
Sat Fault/SIRIUS system failure	There is an internal module or system failure present.	If this message does not clear shortly, or with an ignition key cycle, your receiver may have a fault. See an authorized dealer for service.
Invalid Channel	The channel is no longer available.	Tune to another channel or choose another preset.
Unsubscribed Channel	Your subscription does not include this channel.	Contact Sirius at 1-888-539-7474 to subscribe to the channel, or tune to another channel.
No Signal	The signal is lost from the Sirius satellite or Sirius tower to your vehicle antenna.	The signal is blocked. When you move into an open area, the signal should return.
Updating	Update of channel programming in progress.	No action required. The process may take up to three minutes.

Audio System

87

Radio display	Condition	Possible action
Call SIRIUS 1-888-539-7474	Your satellite service is no longer available.	Call Sirius at 1-888-539-7474 to resolve subscription issues.
None Found. Check Channel Guide.	All the channels in the selected category are either skipped or locked.	Use the channel guide to turn off the Lock or Skip function on that station.
Subscription Updated	Sirius has updated the channels available for your vehicle.	No action required.

MANUAL CLIMATE SYSTEM

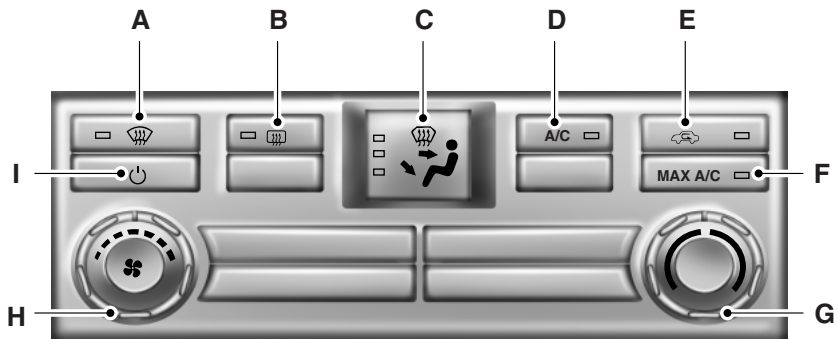

A. Defrost: Distributes air through the windshield defroster vents and demister vents. This setting can also be used to defog and clear the windshield of a thin covering of ice.

B. Heated mirrors: Turns the heated mirrors on and off. See *Heated mirrors* later in this chapter for more information.

C. Air distribution control: Press to set the air distribution to a position listed below:



Distributes air through the windshield defroster vents, demister vents and floor vents.



Distributes air through the instrument panel vents.



Distributes air through the instrument panel vents, floor vents, and demister vents.



Distributes air through the floor vents.

D. **A/C:** Press to turn air conditioning on or off. Air conditioning cools the vehicle using outside air. To improve air conditioning when starting your vehicle, drive with the windows slightly open for two to three minutes.

E. **Recirculated air:** Press to switch between outside air and recirculated air. When the LED on the button is lit, the air currently in the passenger compartment is being recirculated. Using recirculated air can reduce the time needed to cool the interior and reduce unwanted odors from entering your vehicle.

Note: For better cooling in hot conditions, recirculated air automatically engages when the air distribution control is in Panel or Panel/Floor modes and the air conditioning is on. You can switch to fresh air by pressing the recirculated air button again.

F. **MAX A/C:** Distributes recirculated air through the instrument panel vents to cool the vehicle. This position is more economical and efficient than normal A/C.

G. **Temperature control:** Controls the temperature of the air circulated in your vehicle. Turn to select the desired temperature.

H. **Fan speed control:** Controls the volume of air circulated in your vehicle. Turn to select the desired fan speed or switch off. If you switch the fan off, the windshield may fog up.

I. **Power:** Press to turn the system on and off. When the system is off, outside air is prevented from entering the vehicle.

GENERAL OPERATING TIPS

- To reduce fog build-up on the windshield during humid weather, select Defrost. Temperature and fan speed can also be increased to improve clearing.
- To reduce humidity build-up inside the vehicle, do not drive with the system off or with recirculated air engaged.
- Do not put objects under the front seats that interfere with the airflow to the back seats.
- Remove any snow, ice or leaves from the air intake area at the base of the windshield.

Cooling the interior quickly:

1. Adjust the fan speed to the highest speed setting initially and then adjust it to suit the desired comfort level.
2. Adjust the temperature control to the lowest temperature setting.
3. Adjust the air distribution control to the MAX A/C position.

Recommended settings for cooling:

- Adjust the air distribution control to the A/C position.

If your vehicle is stationary for extended periods during extreme high ambient temperatures:

- Select the MAX A/C position.

Gas engines: If your vehicle is stationary for long periods of time in high ambient temperature conditions, your climate control system may automatically switch from fresh air mode to recirculation mode. This is normal system operation as it provides protection of the air conditioning compressor (and related parts). It is recommended that you allow the system to remain in this mode if it has switched. The system reverts back to fresh air mode when conditions allow.

For maximum cooling performance, turn the air distribution control to MAX A/C.

To aid in side window defogging/demisting in cold weather:

1. Select Panel/Floor.
2. Select A/C.
3. Adjust the temperature control to maintain comfort.
4. Set the fan speed to the highest setting.
5. Direct the outer instrument panel vents toward the side windows.
6. To increase airflow to the outer instrument panel vents, close the vents located in the middle of the instrument panel.

HEATED MIRRORS (IF EQUIPPED)

Note: Do not remove ice from the mirrors with a scraper or attempt to readjust the mirror glass if it is frozen in place. These actions could cause damage to the glass and mirrors.

Note: Do not clean the housing or glass of any mirror with harsh abrasives, fuel or other petroleum-based cleaning products.

Both mirrors are heated to remove ice, mist and fog when the heated mirror button is pressed.

SITTING IN THE CORRECT POSITION

 **WARNING:** Do not recline the seat back as this can cause the occupant to slide under the seat's safety belt, resulting in severe personal injury in the event of a crash.

 **WARNING:** Do not place objects higher than the seat backs to reduce the risk of injury in a crash or during heavy braking or when stopping suddenly.

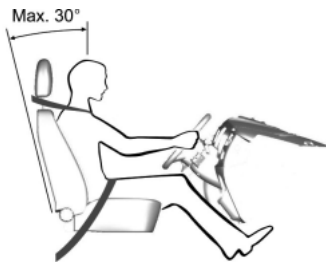



When you use them properly, the seat, head restraint and safety belt provide optimum protection in the event of a crash. We recommend that you follow these guidelines:

- Do not recline the seat back more than 30 degrees from vertical.
- Sit in an upright position with the base of your spine as far back as possible.
- Adjust the head restraint so that the top of it is level with the top of your head and as far forward as possible, remaining comfortable.
- Keep sufficient distance between yourself and the steering wheel. We recommend a minimum of 10 inches (250 millimeters) between your breastbone and the center of the steering wheel.
- Hold the steering wheel with your arms slightly bent.
- Bend your legs slightly so that you can press the pedals fully.
- Position the shoulder strap of the safety belt over the center of your shoulder and position the lap strap tightly across your hips.

Make sure that your driving position is comfortable and that you can maintain full control of your vehicle.

HEAD RESTRAINTS

 **WARNING:** To minimize the risk of neck injury in the event of a crash, you and the passenger occupants should not sit in or operate the vehicle, until the head restraint is placed in its proper position. Never adjust the head restraint while the vehicle is in motion.

 **WARNING:** The adjustable head restraint is a safety device. Whenever possible it should be installed and properly adjusted when the seat is occupied.

 **WARNING:** Install the head restraint properly to minimize the risk of neck injury in the event of a crash.

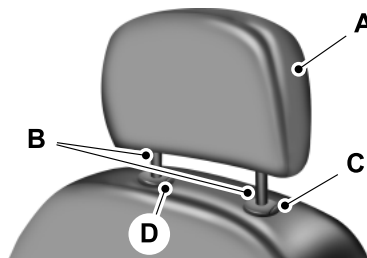
Front Seat Head Restraints

The head restraints consist of:

- A. An energy absorbing head restraint
- B. Two steel stems
- C. Guide sleeve adjust and release button
- D. Guide sleeve unlock and remove button

Note: Adjust the seat back to an upright driving position before adjusting any head restraint. Properly adjust the head restraint so that the top of the head restraint is even with the top of your head and positioned as close as possible to the back of your head. For occupants of extremely tall stature, adjust the head restraint to its full up position.

Front Row Center, Outboard (Crew Cab), and Rear Seat Center (Crew Cab) Head Restraints

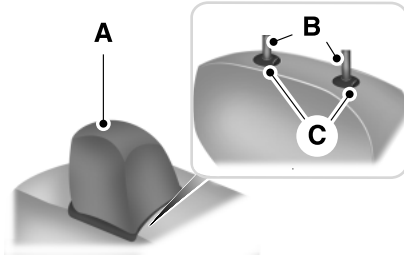

Your vehicle may be equipped with head restraints that are non-adjustable.

The non-adjustable head restraints consist of:

- A. An energy absorbing head restraint
- B. Two steel stems
- C. Guide sleeve unlock and remove buttons

Rear Head Restraints (SuperCab)

The SuperCab has rear outboard head restraints that are not removable and are bolted to the back wall.

Adjusting the Head Restraints

Raise

Pull up the head restraint.

Lower

1. Press and hold button C.
2. Push down on the head restraint.

Remove - Front Seat Head Restraints

1. Pull up the head restraint until it reaches the highest adjustment position.
2. Press and hold buttons C and D.
3. Pull up the head restraint.

Remove - Front Row Center, Outboard (Crew Cab), and Rear Seat Center (Crew Cab) Head Restraints

1. Pull up the head restraint until it reaches the highest adjustment position.
2. Press and hold buttons C.
3. Pull up the head restraint.

Reinstall

Align the steel stems into the guide sleeves and push the head restraint down until it locks.

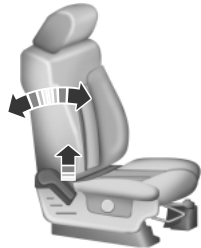
MANUAL SEATS**Moving the Seats Backward and Forward****Recline Adjustment**

Tilting the Seat Back Forward (Two-passenger Bench Seat)

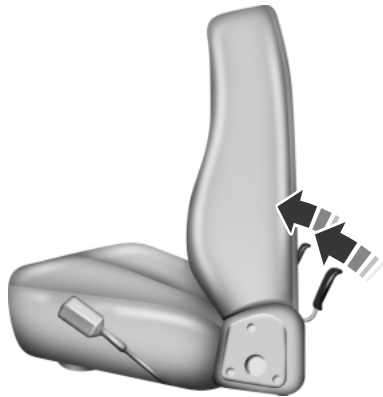

Manual Lumbar (If Equipped)

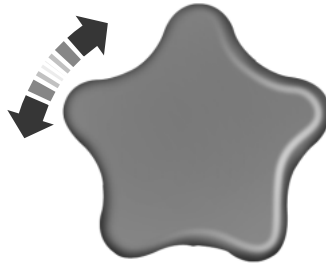

The lumbar support control is located on the outboard side of the seat. Turn the control to adjust your support.

POWER SEATS

WARNING: Never adjust the driver's seat when the vehicle is moving.



WARNING: To reduce the risk of excess slack in the belt system, always adjust the seat height before fastening the seat belt.

Non Air-Ride Seat

The control is located on the outboard side of the seat cushion.

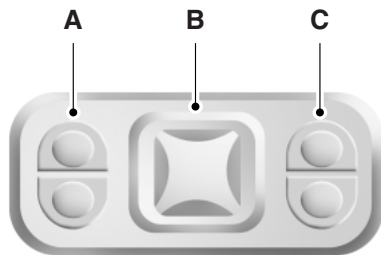

- Press A to raise or lower the front portion of the seat cushion.
- Press B to move the seat forward, backward, up or down.
- Press C to raise or lower the rear portion of the seat cushion.

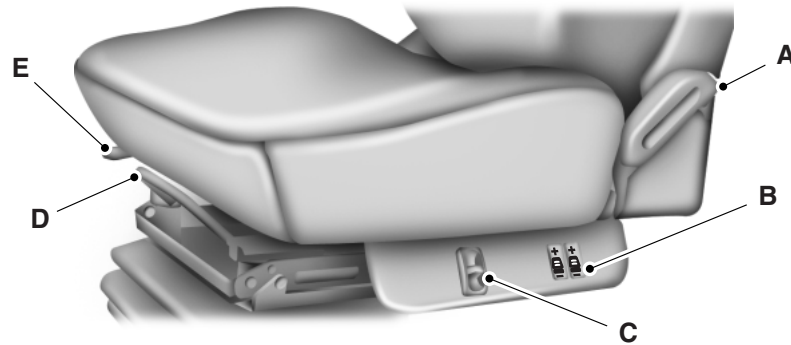
Air-Ride Seat

- A. **Recline:** Lift the handle to adjust the angle of the seat back.
- B. **Power lumbar:**
- Press the top of the forward control to inflate the lower lumbar support.
 - Press the bottom of the forward control to deflate the lower lumbar support.
 - Press the top of the rear control to inflate the upper lumbar support.
 - Press the bottom of the rear control to deflate the upper lumbar support.
- C. **Seat height adjuster:**
- Pull the control up to raise the seat.
 - Push the control down to lower the seat.
- D. **Seat adjuster:**
- Lift the bar up to move the seat forward or backward.
 - Release the bar to lock the seat in position.
- E. **Chugger option:** Dampens road vibrations and allows the seat to move with the driver when unlocked.
- To unlock, sit in the seat and slide the tab away to the right.
 - To lock, sit in the seat and slide the tab to the left.

REAR SEATS**Folding Up the Rear Seats (SuperCab)**

1. Pull the control to release the seat cushion.
2. Rotate the seat cushion up until it locks into the vertical storage position.

Returning the Seat to the Seating Position

WARNING: Make sure that cargo or any objects are not trapped underneath the seat cushion before returning the seat cushion to its original position, and that the seat cushion locks into place. Failure to do so may prevent the seat from operating properly in the event of a crash, which could increase the risk of serious injury.

1. Pull the control on the side of the seat to release the seat cushion from the storage position.
2. Push the seat cushion down until it locks into the horizontal position.

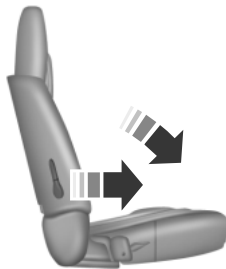
Folding the Rear Seat Back (Crew Cab)

1. Pull forward on the control to fold down the seat back.
2. Pull down on the handle and lift up on the seat back to return it to the original position.

REAR SEAT ARMREST (IF EQUIPPED)

To use the armrest, rotate it forward from the seat back.

HEATED SEATS (IF EQUIPPED)

WARNING: Persons who are unable to feel pain to the skin because of advanced age, chronic illness, diabetes, spinal cord injury, medication, alcohol use, exhaustion, or other physical conditions, must exercise care when using the seat heater. The seat heater may cause burns even at low temperatures, especially if used for long periods of time. Do not place anything on the seat that insulates against heat, such as a blanket or cushion, because this may cause the seat heater to overheat. Do not puncture the seat with pins, needles, or other pointed objects because this may damage the heating element which may cause the seat heater to overheat. An overheated seat may cause serious personal injury.

Note: Do not do the following:

- Place heavy objects on the seat.
- Operate the seat heater if water or any other liquid is spilled on the seat. Allow the seat to dry thoroughly.
- Operate the heated seats unless the engine is running. Doing so could drain your vehicle's battery.



Press to cycle through the various heat settings and off. Warmer settings are indicated by more indicator lights.

FRONT SEAT ARMREST (IF EQUIPPED)

To release the armrest and gain access to the cupholders and seat back storage bin, press the button on the right-hand side of the seat and pull the seat back down.

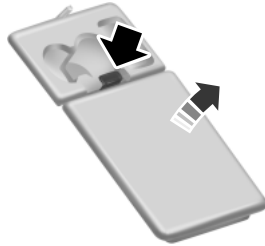

Pull up on the tab to open the storage bin.

Lift up on the seat back to return it to the upright position.

AUXILIARY POWER POINTS



WARNING: Do not plug optional electrical accessories into the cigarette lighter socket (if equipped). Improper use of the lighter can cause damage not covered by your warranty, and can result in fire or serious injury.

Note: If used when the engine is not running, the battery will discharge. There may be insufficient power to restart your engine.

Note: Do not insert objects other than an accessory plug into the power point. This will damage the outlet and blow the fuse.

Note: Do not hang any type of accessory or accessory bracket from the plug.

Note: Do not use the power point over the vehicle capacity of 12-volt DC 180 watts or a fuse may blow.

Note: Do not use the power point for operating a cigarette lighter element.

Note: Improper use of the power outlet can cause damage not covered by your warranty.

Note: Always keep the power point caps closed when not in use.

Run the engine for full capacity use of the power point. To prevent the battery from being discharged:

- Do not use the power point longer than necessary when the engine is not running.
- Do not leave devices plugged in overnight or when the vehicle is parked for extended periods.

Locations

Power points may be found:

- on the instrument panel (two locations).
- inside the center console storage compartment (if equipped).
- on the rear of the center console (if equipped).
- inside the 20-percent front seat console (if equipped).
- inside the rear under seat storage compartment (if equipped).

102 Starting and Stopping the Engine

GENERAL INFORMATION

 **WARNING:** Extended idling at high engine speeds can produce very high temperatures in the engine and exhaust system, creating the risk of fire or other damage.

 **WARNING:** Do not park, idle, or drive your vehicle on dry grass or other dry ground cover. The emission system heats up the engine compartment and exhaust system, which can start a fire.

 **WARNING:** Do not start your vehicle in a closed garage or in other enclosed areas. Exhaust fumes can be toxic. Always open the garage door before you start the engine.

 **WARNING:** If you smell exhaust fumes inside your vehicle, have your vehicle checked by an authorized dealer immediately. Do not drive if you smell exhaust fumes.

If you disconnect the battery, your vehicle may exhibit some unusual driving characteristics for approximately five miles (eight kilometers) after you connect it. This is because the engine management system must realign itself with the engine. You may disregard any unusual driving characteristics during this period.

The powertrain control system meets all Canadian interference-causing equipment standard requirements regulating the impulse electrical field strength of radio noise.

When starting your vehicle, avoid pressing the accelerator pedal before and during operation. Only use the accelerator pedal when you have difficulty starting the engine.

If your vehicle is operated in a heavy snow storm or blowing snow conditions, the engine air induction may become partially clogged with snow or ice. If this occurs, the engine may experience a significant reduction in power output. At the earliest opportunity, clear all the snow or ice away from the air induction inlet.

IGNITION SWITCH

Note: When you switch the ignition off and leave your vehicle, do not leave your key in the ignition. This could discharge your vehicle battery.

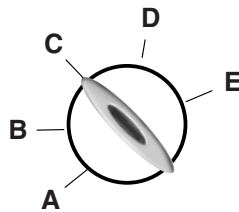

- A. **Accessory:** Allows the electrical accessories, such as the radio, to operate while the engine is not running.
- B. **Lock:** Locks the automatic transmission gearshift lever, if equipped with position **P**, and allows key removal.
- C. **Off:** Shuts off the engine and all accessories.
- D. **On:** All electrical circuits are operational. Warning lights are illuminated. Key position when driving.
- E. **Start:** Cranks the engine. Release the key as soon as the engine starts.

STARTING A GASOLINE ENGINE

When the engine starts, the idle RPM runs faster to warm the engine. If the engine idle speed does not slow down automatically, have the vehicle checked.

Before starting the vehicle:

- Make sure all occupants buckle their safety belts.
- Make sure the headlamps and electrical accessories are off.
- Make sure the parking brake is set.
- Make sure the gearshift is in position **P**.
- Turn the key to on without turning the key to start.

Some warning lights briefly illuminate.

Note: Do not touch the accelerator pedal.

1. Fully press the brake pedal.

104 Starting and Stopping the Engine

2. Turn the key to start the engine. The engine may continue cranking for up to 15 seconds or until the vehicle starts.

Note: If the engine does not start on the first try, wait for a short period of time and try again.

If you have difficulty starting the engine when the temperature is below -13°F (-25°C), press the accelerator pedal slightly and try again.

If the engine does not start after three attempts, wait 10 seconds and follow this flooded engine procedure.

1. Select position **P** or **N**.
2. Fully press the accelerator pedal and hold it there.
3. Fully press the brake pedal.
4. Start the engine.

Guarding Against Exhaust Fumes



WARNING: If you smell exhaust fumes inside your vehicle, have this checked immediately. Do not drive your vehicle if you smell exhaust fumes. Carbon monoxide is present in exhaust fumes. Take precautions to avoid its dangerous effects.

Important Ventilating Information

If you stop your vehicle and leave the engine idling for long periods of time, we recommend that you do one of the following:

- Open the windows at least 1 inch (2.5 centimeters).
- Set your climate control to outside air.

STARTING A DIESEL ENGINE

WARNING: Operation of a diesel engine near flammable vapors in the air may cause the engine speed to increase uncontrollably and over speed. If this situation occurs, mechanical damage, fire, explosion, personal injury or death could result. *Turning off the ignition key does not slow or stop the engine due to uncontrollable fueling of the engine through flammable vapors being drawn into the engine air inlet.* Operation of components such as starter, alternator, electric motors, etc. and static electricity could also ignite flammable vapors.

Do not operate the truck in the possible presence of flammable vapors unless both a complete hazard analysis is performed and necessary additional safety processes and/or equipment such as vapor testing, air intake shutoff devices, ventilation, etc. are utilized. The operator is responsible for using those processes and/or equipment to ensure that the diesel engine and all other components on the truck can be operated safely under the specific conditions and hazards that may be encountered.



WARNING: If equipped with an air intake heater, DO NOT use ether or any other starting fluids. The use of starting fluids (ether) in an engine equipped with an air intake heater could cause an explosion and result in property damage and/or personal injury.



Switch the ignition on and wait until the glow plug indicator goes off.

Note: You can only operate the starter for a maximum of 30 seconds at a time. Allow two minutes before cranking the starter again.

Note: On some engines, the glow plug indicator illuminates after the engine starts. Allow the engine to idle about three minutes, or until the engine coolant temperature gauge begins to rise. Maintain idle speed until the glow plug indicator goes off. Operating the engine at higher speeds reduces the effectiveness of the air inlet heater.

Note: When starting a cold engine, increase the engine RPM slowly to make sure adequate lubrication is available to the bearings.

106 Starting and Stopping the Engine

Note: Do not increase engine speed until the oil pressure gauge indicates normal pressure. This should be indicated on the gauge within 15 seconds after starting.

Note: Idle the engine for three to five minutes before operating with a full load.

Note: Try to limit engine idle to 10 minutes. Excessive idling reduces fuel economy.

Vehicles with a Manual Transmission

Note: Do not touch the accelerator pedal.

1. Fully press the clutch pedal.
2. Start the engine.

Vehicles with an Automatic Transmission

Note: Do not touch the accelerator pedal.

1. Select position **N**, or **P** (if equipped with a Park position).
2. Fully press the brake pedal.
3. Start the engine.

Starting the Engine with the Vehicle on a Steep Grade

When starting a diesel engine when the loaded vehicle is on a grade, the engine RPM starts to fall slightly when the clutch is engaged. Do not disengage the clutch and try to increase engine RPM as this may damage driveline components. The engine recovers as the vehicle begins moving.

DIESEL PARTICULATE FILTER (DPF)







WARNING: The normal operating temperature of the exhaust system is very high. Never work around, or attempt to repair, any part of the exhaust system until it has cooled. Use special care when working around the diesel particulate filter. The DPF heats up to a high temperature after only a short period of engine operation, and can remain hot even after the engine is turned off. Failure to follow these instructions may result in serious personal injury.

Your vehicle is equipped with a diesel particulate filter (DPF), as part of the after-treatment exhaust system, to trap soot and other large particles produced by the engine combustion process. The soot that accumulates in the filter must be periodically reduced to ash to prevent excessive exhaust restriction. The soot reduction process, also known as “filter regeneration,” is generally performed automatically by your engine and after-treatment system.

Regeneration

Unlike a normal filter which requires periodic replacement, the DPF has been designed to regenerate, or clean itself to maintain operating efficiency. The regeneration process takes place automatically. A small increase in engine/turbo sound-level is normal during filter regeneration. However, some driving conditions mean that you may need to support the regeneration process:

- Operating in stop-and-go traffic or maintaining low speeds as in city or delivery driving
- Frequent engine starting and stopping
- Relatively light vehicle payload
- Regular operation in cold ambient temperatures (i.e., below 0°F [-18°C]).

Diesel Particulate Filter Four-level Loading Chart		
Level/Lamp status	Filter status	Requested action
Level 1  solid	Regeneration required.	Drive on the highway at highway speeds OR start parked regeneration to prevent loss of engine performance.
Level 2  flashing (once per second)	Nearly full. Engine performance is limited.	
Level 3  flashing +  solid	Full. Engine performance is increasingly limited.	Perform parked regeneration to prevent loss of engine performance.
Level 4  solid	Over full. Engine performance is highly limited. Continued operation may result in irreparable damage to the filter.	Pull vehicle safely off roadway, turn on hazard flashers and shut down engine as soon as possible. Seek service immediately.



Instrument cluster lamp(s) illuminates or flashes when operator assistance is required. In addition, engine performance becomes increasingly limited above Level 1.

At Levels 1 and 2, two courses of action may be taken by the operator to facilitate filter regeneration:

1. The vehicle may be driven on the highway at highway speeds.
2. The operator may perform a parked regeneration by following the steps in *Parked regeneration*.

At Level 3, performing a parked regeneration is the only available course of action (short of professional servicing) available to the operator for regenerating the filter. At Level 4, professional servicing is the only way to regenerate the filter.

Parked Regeneration



WARNING: When performing the parked regeneration procedure, make certain the vehicle is safely off the roadway, and the exhaust system is away from people, or any flammable materials, vapors, or structures. Engine speed may increase during parked regeneration.

Note: Parked regeneration is only available when the DPF lamp on the instrument cluster is illuminated (solid or flashing).

1. Bring the vehicle to a complete stop on level ground and safely off the road with the exhaust system away from people, flammable materials, vapors or structures. Ford recommends that you perform a walk-around before beginning a parked regeneration.
2. If your vehicle is equipped with an automatic transmission and a steering column shift lever, place the transmission in position **P**. Otherwise, place the transmission in position **N**.
3. Remove your feet from the accelerator pedal and clutch pedal (if equipped).
4. Set the parking brake.
5. **Within five seconds of setting the parking brake**, remove your foot from the service brake pedal.

The engine speed may increase slightly. To allow parked regeneration to continue uninterrupted:

1. The vehicle must remain parked.
2. The transmission must remain in position **P** or **N** (as previously described in Step 2).

3. The accelerator pedal, service brake pedal, and clutch pedal (if equipped) must not be pressed.
4. The parking brake must remain set.

On average (depending on filter level and other factors), the process takes 20–30 minutes to complete. The DPF lamp turns off when the process is complete. Repeat Steps 1–5, if parked regeneration is interrupted.

To Discontinue Parked Regeneration

Press any of the floor pedals to discontinue parked regeneration.

Maintenance and Service

The DPF is designed to retain a relatively large amount of residual ash and provide many miles and hours of maintenance-free operation. At some point, generally beyond 150000 miles (240000 kilometers) or 5000 hours of operation (whichever comes first), the DPF requires professional cleaning to remove the accumulated ash.

The exact number of miles or hours of operation varies greatly depending upon vehicle and engine loading and operating conditions, ash content of the engine oil, and quality of the diesel fuel used in your truck. Adhering to your engine manufacturer's recommended oil and fuel specifications maximizes the miles and hours of operation before a DPF professional cleaning is required. See your engine manufacturer's owner's manual for more details regarding recommended maintenance and service of your DPF.

Exhaust Outlet Assembly



WARNING: The normal operating temperature of the exhaust system is very high. Never work around or attempt to repair any part of the exhaust system until it has cooled. Failure to follow these instructions may result in serious personal injury.

Note: Do not modify or remove this device. Modification of the system or additions of aftermarket devices can reduce the effectiveness of the system, as well as cause damage to the exhaust system or engine. Any modifications may also invalidate the vehicle and/or engine warranties. See your warranty information.

Note: Blocked or plugged holes or modification to, or removal of, the outlet assembly could result in elevated exhaust temperatures which may result in vehicle or property damage or personal injury.

110 Starting and Stopping the Engine

The exhaust outlet assembly on your vehicle is a uniquely functioning device that accompanies the DPF assembly. It is designed to help control the temperature of the exhaust during the DPF regeneration process.

The inlet holes in the side of the assembly are functional. These holes allow outside air to be drawn into the outlet assembly. The holes need to be kept clear of mud and other foreign material to maintain proper functionality of the system. One way to keep the holes clear is to spray the outlet assembly with a hose when washing the vehicle. Failure to keep the functional holes clear of foreign material may result in the holes becoming blocked or plugged.

SWITCHING OFF A DIESEL ENGINE

Allow the engine to idle for three to five minutes before shutting it down; the larger the engine, the greater the need for this idling period.

Note: Try to limit engine idle to 10 minutes. Excessive idling reduces fuel economy.

ENGINE AUTOMATIC SHUTDOWN (IF EQUIPPED)



WARNING: In the event of engine shutdown, make sure the vehicle is safely off the road and the problem is remedied prior to returning to the road. Failure to remove the vehicle from the road could result in an accident, causing serious injury or death.

This feature either illuminates a light in the instrument cluster or sounds a chime (or both) indicating that the engine is being shut down in the event of high coolant temperature, low engine oil pressure, high diesel particulate filter soot loading or low engine coolant level. In the event any of these conditions exist, the engine automatically shuts down.

If the engine shuts down, it can be restarted and operated for 30 seconds at a time or until the problem is corrected. Do not attempt to use this restarting feature to drive the vehicle very far as serious engine damage could result.

ENGINE BLOCK HEATER (IF EQUIPPED)

WARNING: Failure to follow engine block heater instructions could result in property damage or physical injury.



WARNING: Do not use your heater with ungrounded electrical systems or two-pronged (cheater) adapters. There is a risk of electrical shock.

Note: The heater is most effective when outdoor temperatures are below 0°F (-18°C).

The heater acts as a starting aid by warming the engine coolant. This allows the climate control system to respond quickly. The equipment includes a heater element (installed in the engine block) and a wire harness. You can connect the system to a grounded 120-volt A/C electrical source.

We recommend that you do the following for safe and correct operation:

- Use a 16-gauge outdoor extension cord that is product certified by Underwriter's Laboratory or Canadian Standards Association. This extension cord must be suitable for use outdoors, in cold temperatures, and be clearly marked *Suitable for Use with Outdoor Appliances*. Never use an indoor extension cord outdoors; it could result in an electric shock or become a fire hazard.
- Use as short an extension cord as possible.
- Do not use multiple extension cords.
- Make sure that when in operation, the extension cord plug and the heater cord plug connections are free and clear of water. This could cause an electric shock or fire.
- Make sure your vehicle is parked in a clean area, clear of combustibles.
- Make sure the heater, heater cord and extension cord are firmly connected.
- Check for heat anywhere in the electrical hookup once the system has been operating for approximately 30 minutes.
- Make sure the system is unplugged and properly stowed before driving your vehicle. Make sure the protective cover seals the prongs of the block heater cord plug when not in use.

112 **Starting and Stopping the Engine**

- Keep plug terminals clean and free of dirt and corrosion.
- Make sure the heater system is checked for proper operation before winter.

Using the Engine Block Heater

Make sure the receptacle terminals are clean and dry prior to use. Clean them with a dry cloth, if necessary.

The heater uses 0.4 to 1.0 kilowatt-hours of energy per hour of use. The system does not have a thermostat. It achieves maximum temperature after approximately three hours of operation. Using the heater longer than three hours does not improve system performance and unnecessarily uses electricity.

SAFETY PRECAUTIONS

WARNING: Do not overfill the fuel tank. The pressure in an overfilled tank may cause leakage and lead to fuel spray and fire.



WARNING: The fuel system may be under pressure. If you hear a hissing sound near the fuel filler inlet, do not refuel until the sound stops. Otherwise, fuel may spray out, which could cause serious personal injury.



WARNING: Automotive fuels can cause serious injury or death if misused or mishandled.



WARNING: The flow of fuel through a fuel pump nozzle can produce static electricity, which can cause a fire if fuel is pumped into an ungrounded fuel container.



WARNING: Fuel ethanol and gasoline may contain benzene, which is a cancer-causing agent.



WARNING: When refueling always shut the engine off and never allow sparks or open flames near the filler neck. Never smoke while refueling. Fuel vapor is extremely hazardous under certain conditions. Care should be taken to avoid inhaling excess fumes.

Observe the following guidelines when handling automotive fuel:

- Extinguish all smoking materials and any open flames before refueling your vehicle.
- Always turn off the vehicle before refueling.
- Automotive fuels can be harmful or fatal if swallowed. Fuel, such as gasoline, is highly toxic and if swallowed can cause death or permanent injury. If fuel is swallowed, call a physician immediately, even if no symptoms are immediately apparent. The toxic effects of fuel may not be visible for hours.
- Avoid inhaling fuel vapors. Inhaling too much fuel vapor of any kind can lead to eye and respiratory tract irritation. In severe cases, excessive or prolonged breathing of fuel vapor can cause serious illness and permanent injury.

- Avoid getting fuel liquid in your eyes. If fuel is splashed in the eyes, remove contact lenses (if worn), flush with water for 15 minutes and seek medical attention. Failure to seek proper medical attention could lead to permanent injury.
- Fuels can also be harmful if absorbed through the skin. If fuel is splashed on the skin or clothing, promptly remove contaminated clothing and wash skin thoroughly with soap and water. Repeated or prolonged skin contact with fuel liquid or vapor causes skin irritation.
- Be particularly careful if you are taking Antabuse or other forms of disulfiram for the treatment of alcoholism. Breathing gasoline vapors, or skin contact could cause an adverse reaction. In sensitive individuals, serious personal injury or sickness may result. If fuel is splashed on the skin, promptly wash skin thoroughly with soap and water. Consult a physician immediately if you experience an adverse reaction.

CHOOSING THE RIGHT FUEL

Note: Use of any fuel other than those recommended may cause powertrain damage, a loss of vehicle performance, and repairs may not be covered under warranty.

Gasoline Engine

Use only UNLEADED fuel or UNLEADED fuel blended with a maximum of 15% ethanol. Do not use fuel ethanol (E85), diesel fuel, fuel-methanol, leaded fuel or any other fuel because it could damage or impair the emission control system. The use of leaded fuel is prohibited by law.

Diesel Engine

WARNING: Using low sulfur (16-500 ppm) or high sulfur (greater than 500 ppm) diesel fuel in a diesel engine designed to use only Ultra Low Sulfur Diesel fuel increases the likelihood of engine oil dilution with fuel which may lead to major engine damage.



WARNING: Using low sulfur (16-500 ppm) or high sulfur (greater than 500 ppm) diesel fuel in a diesel engine designed to use only Ultra Low Sulfur Diesel fuel causes certain emission components to malfunction which may also cause the Service Engine Soon light to illuminate indicating an emissions-related concern.

 **WARNING:** Do not mix diesel fuel with gasoline, gasohol or alcohol. This could cause an explosion resulting in personal injury.

 **WARNING:** Do not use starting fluid such as ether or gasoline. Such fluids can cause immediate explosive damage to the engine and possible personal injury.

 **WARNING:** Do not use home heating oil or any diesel fuel not intended for highway use. Red dye is used to identify fuels intended for agricultural and non-highway use. Damage to the fuel injection system, engine and exhaust catalyst can occur if an improper fuel is used. Do not add gasoline, gasohol or alcohol to diesel fuel. This practice creates a serious fire hazard and engine performance problems.

Note: Use of any fuel other than those recommended may cause powertrain damage, a loss of vehicle performance, and repairs may not be covered under warranty.

Use only Ultra Low Sulfur (15 ppm Sulfur Maximum) number 1-D or 2-D diesel fuel in your diesel engine. The engine and exhaust system were designed to only use this fuel. Look for the ULTRA-LOW SULFUR HIGHWAY DIESEL FUEL (15 ppm Sulfur Maximum) label on fuel pumps when purchasing your fuel.

Number 1-D or winter blend number 2-D fuel is recommended at temperatures below 20°F (-7°C). Diesel fuel containing no more than 20% biodiesel may be used. Biodiesel fuel is a product that has been converted from renewable fuel sources, including vegetable oil, animal fat and cooking oil. Raw or refined vegetable oil, animal fat, cooking oil or recycled greases should not be used. All biodiesel up to B20 must comply with ASTM D7467 standards.

See your engine operator's manual for additional information and restrictions regarding use of biodiesel fuel.

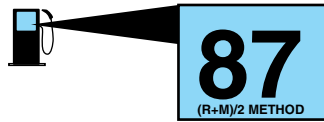
Octane Recommendations - Gasoline Engines

Regular unleaded gasoline with a pump (R+M)/2 octane rating of 87 is recommended. Some stations offer fuels posted as Regular with an octane rating below 87, particularly in

high altitude areas. Do not use fuels with a posted octane rating below 87.

Do not be concerned if your engine sometimes knocks lightly. However, if it knocks heavily under most driving conditions while you are using fuel with the recommended octane rating, see your authorized dealer to prevent any engine damage.

RUNNING OUT OF FUEL**Gasoline Engine**

Avoid running out of fuel because this situation may have an adverse effect on powertrain components.

If you have run out of fuel:

- You may need to cycle the ignition from off to on several times after refueling to allow the fuel system to pump the fuel from the tank to the engine. On restarting, cranking time takes a few seconds longer than normal.
- **If your vehicle is equipped with dual fuel tanks**, adding four–five gallons (15–19 liters) of fuel is enough to restart the engine. If the vehicle is out of fuel and on a steep grade, more than four–five gallons (15–19 liters) may be required.
- The service engine soon indicator may come on. For more information on the service engine soon indicator, see the *Instrument Cluster* chapter.

See *General information* in the *Information Displays* chapter for information on Miles to Empty.

Diesel Engine

Avoid running out of fuel as this allows air to enter the fuel system, which makes restarting the vehicle difficult.

If you have run out of fuel:

- **If your vehicle is equipped with dual fuel tanks**, adding four–five gallons (15–19 liters) of fuel is enough to restart the engine. If the vehicle is out of fuel and on a steep grade, more than four–five gallons (15–19 liters) may be required.

- The fuel system must be primed before attempting to restart the engine. See your engine operator's manual for instructions on priming the engine.
- Use caution not to overheat and damage the starter by cranking the engine for an excessive period of time. You may need to crank the engine for a longer time than normal. If the engine fails to start in 30 seconds, turn the ignition to the off position and wait for two minutes before cranking the engine again.
- Any remaining trapped air self-purges from the fuel system once the engine starts running.
- The engine may run rough and produce white smoke while air is in the fuel system. This is normal and should stop after a short period of time.

See *General information* in the *Information Displays* chapter for information on Miles to Empty.

REFUELING



WARNING: Fuel vapor burns violently and a fuel fire can cause severe injuries. To help avoid injuries to you and others:

- Read and follow all the instructions on the pump island.
- Turn off your engine when you are refueling.
- Do not smoke if you are near fuel or refueling your vehicle.
- Keep sparks, flames and smoking materials away from fuel.
- Stay outside your vehicle and do not leave the fuel pump unattended when refueling your vehicle - this is against the law in some places.
- Keep children away from the fuel pump; never let children pump fuel.
- Do not use personal electronic devices while refueling.

Use the following guidelines to avoid electrostatic charge build-up when filling an ungrounded fuel container:

- Place approved fuel container on the ground.
- DO NOT fill a fuel container while it is in the vehicle (including the cargo area).
- Keep the fuel pump nozzle in contact with the fuel container while filling.
- DO NOT use a device that would hold the fuel pump handle in the fill position.

Fuel Filler Cap

WARNING: The fuel system may be under pressure. If the fuel filler cap is venting vapor or if you hear a hissing sound, wait until it stops before completely removing the fuel filler cap. Otherwise, fuel may spray out and injure you or others.



WARNING: If you do not use the proper fuel filler cap, excessive pressure or vacuum in the fuel tank may damage the fuel system or cause the fuel cap to disengage in a crash, which may result in possible personal injury.

Note: If you must replace the fuel filler cap, replace it with a fuel filler cap that is designed for your vehicle. The customer warranty may be void for any damage to the fuel tank or fuel system if the correct genuine Ford, Motorcraft® or other certified fuel filler cap is not used.

Your fuel tank filler cap has an indexed design with a ¼-turn on and off feature. When fueling your vehicle:

1. Turn the engine off.
2. Carefully turn the filler cap counterclockwise until it spins off.
3. Pull to remove the cap from the fuel filler pipe.
4. To install the cap, align the tabs on the cap with the notches on the filler pipe.
5. Turn the filler cap clockwise a ¼-turn until it clicks at least once.

If the check fuel cap light appears in the instrument cluster and stays on after you start the engine, the fuel filler cap may not be properly installed.

If the fuel cap light remains on, at the next opportunity, safely pull off of the road, remove the fuel filler cap, align the cap properly and reinstall it. The check fuel cap light may not reset immediately; it may take several driving cycles for the indicators to turn off. A driving cycle consists of an engine start-up (after four or more hours with the engine off) followed by normal city and highway driving.

FUEL CONSUMPTION**Filling the Tank**

The advertised capacity is the indicated capacity and the empty reserve combined. Indicated capacity is the difference in the amount of fuel in a full tank and a tank when the fuel gauge indicates empty. Empty reserve is the amount of fuel in the tank after the fuel gauge indicates empty.

Note: The amount of usable fuel in the empty reserve varies and should not be relied upon to increase driving range. When refueling your vehicle after the fuel gauge indicates empty, you might not be able to refuel the full amount of the advertised capacity of the fuel tank due to the empty reserve still present in the tank.

For consistent results when filling the fuel tank:

- Turn the ignition off before fueling. An inaccurate reading results if the engine is left running.
- Use the same fill rate (low–medium–high) each time the tank is filled.
- Allow no more than two automatic click–offs when filling.
- Have the vehicle loading and distribution the same every time.
- When refueling a vehicle equipped with dual fuel tanks, if the two tanks are not filled equally, the fuel gauge reading may fluctuate slightly until the fuel level between the two tanks balances out and becomes equal.

Note: For vehicles equipped with dual fuel tanks, engine performance may degrade if fuel is not added to both tanks when refueling.

Results are most accurate when the filling method is consistent.

Calculating Fuel Economy

Do not measure fuel economy during the first 1000 miles (1600 kilometers) of driving (this is your engine's break-in period); a more accurate measurement is obtained after 2000–3000 miles (3200–4800 kilometers). Also, fuel expense, frequency of fill-ups or fuel gauge readings are not accurate ways to measure fuel economy.

1. Fill the fuel tank completely and record the initial odometer reading.
2. Each time you fill the tank, record the amount of fuel added.
3. After at least three to five tank fill-ups, fill the fuel tank and record the current odometer reading.
4. Subtract your initial odometer reading from the current odometer reading.
5. Calculate fuel economy as follows:
 - Standard: Divide miles traveled by gallons used.
 - Metric: Multiply liters used by 100, then divide by kilometers traveled.

Keep a record for at least one month and record the type of driving (city or highway). This provides an accurate estimate of the vehicle's fuel economy under current driving conditions. Additionally, keeping records during summer and winter shows how temperature impacts fuel economy. In general, lower temperatures mean lower fuel economy.

SELECTIVE CATALYTIC REDUCTION (SCR) SYSTEM (DIESEL ENGINE ONLY)

Your vehicle is equipped with a selective catalytic reduction (SCR) system to help reduce emission levels of oxides of nitrogen from the exhaust of the diesel engine. The system automatically injects diesel exhaust fluid (DEF) into the exhaust system to enable proper SCR function.

Importance of Maintaining the DEF Level

In order for the SCR system to operate properly, the DEF level must be maintained. Generally, the DEF tank should be filled before the DEF gauge in the instrument cluster reaches the first low level warning (see *Warning messages and vehicle operations*).









The engine control unit monitors the amount of fluid available in the DEF tank. Failure to maintain an adequate amount of DEF in the system generates warning messages that appear in the information display and, unless the DEF tank is refilled, leads to a forced reduction of engine operations.







Warning Messages and Vehicle Operations

The instrument cluster contains a DEF gauge and indicator lights to alert you to any low DEF level conditions. The indicator lights illuminate if the DEF gauge level drops below 0.5 gallons (1.9 liters) in the 5 gallon (19.0 liters) DEF tank or 1 gallon (3.8 liters) in the 9 gallon (34.0 liters) DEF tank.

Upon filling the DEF tank after a low level warning, normal operation resumes when the vehicle is restarted.

Continued driving without refilling results in the following actions as required by the U.S. Environmental Protection Agency (EPA):





Low DEF Level Warning Indications and Vehicle Consequences			
DEF Tank Level	Indicator Lamps	Consequence	Remedy
Above initial warning threshold (Over 20% full).	None.	None.	None.
Initial warning threshold (20% full).	DEF solid 	None.	Add 1 gallon (3.8L) DEF to 5 gallon (19.0L) tank or 2 gallons (7.6L) DEF to 10 gallon (34.0L) tank.
Critical warning threshold (15% full).	DEF blinking 	None.	
First vehicle consequence (12.5% full).	DEF blinking  / Amber engine solid 	25% torque reduction.	
Second vehicle consequence (Empty). System cannot maintain DEF pressure.	DEF blinking  / Amber engine solid 	Torque reduction increases from 25% to 40% at rate of 1% each minute.	
Final vehicle consequence (Empty) and engine intentionally shut down (key off), in extended idle for one hour or fuel tank refilled.	DEF blinking  / Amber engine solid  / Red engine solid 	<ul style="list-style-type: none"> • 40% torque reduction • 5 mph (8 km/h) vehicle speed limit • 1000 RPM engine speed limit. 	

Low DEF Level Warning Indications and Vehicle Consequences for Emergency Vehicles			
DEF Tank Level	Indicator Lamps	Consequence	Remedy
Above initial warning threshold (Over 25% full).	None.	None.	None.
Below initial warning threshold (25% full).	DEF solid 	None.	Add 1 gallon (3.8L) DEF to 5 gallon (19.0L) tank or 2 gallons (7.6L) DEF to 10 gallon (34.0L) tank.
Critical warning threshold (20% full).	DEF blinking 	None.	
First vehicle consequence (15% full).	DEF blinking  / Amber engine solid 	Vehicle speed limited to 55 mph (88 km/h).*	Add 1 gallon (3.8L) DEF to 5 gallon (19.0L) tank or 2 gallons (7.6L) DEF to 10 gallon (34.0L) tank. Allow the system to prime.
Final vehicle consequence (Empty) and engine intentionally shut down (key off) or in extended idle for one hour.	DEF blinking  / Amber engine solid  / Red engine solid 	Vehicle speed limited to 25 mph (40 km/h).**	

*The vehicle speed restriction is suspended during pump operation when using any of the following engine control modes:





- Power take-off
- Remote power take-off
- Remote throttle
- SAE J1939–commanded pressure governor.

**Those installations using a transmission tailshaft-driven power take-off or pump during a stationary operation are also limited to 25 mph (40 km/h) equivalent tailshaft speed during a final vehicle consequence.

Incorrect DEF Quality Warning Indications and Vehicle Consequences			
Condition	Indicator Lamps	Consequence	Remedy
Correct DEF quality.	None.	None.	None.
Initial warning when incorrect DEF quality is detected.	Amber engine solid 	None.	Replace DEF with Ford-approved
Initial warning one hour after incorrect DEF quality is detected.	Amber engine solid 	25% torque reduction.	
Initial warning three hours after incorrect DEF quality is detected.	Amber engine solid 	Torque reduction increases from 25% to 40% at rate of 1% each minute.	
Final vehicle consequence three hours after incorrect DEF quality is detected and engine intentionally shut down (key off), in extended idle for one hour or fuel tank refilled.*	Amber engine solid  / Red engine solid 	<ul style="list-style-type: none"> • 25% torque reduction • 5 mph (8 km/h) vehicle speed limit • 1000 RPM engine speed limit.** 	





*Refueling the fuel tank is defined as increasing the fuel volume level by 15%.

**Final consequence for vehicles equipped with a manual transmission is 1000 RPM. Final consequence for vehicles equipped with an automatic transmission is 1100 RPM.

Incorrect DEF Quality Warning Indications and Vehicle Consequences for Emergency Vehicles			
Condition	Indicator Lamps	Consequence	Remedy
Correct DEF quality.	None.	None.	None.
Initial warning when incorrect DEF quality is detected.	Amber engine solid 	None.	Replace DEF with Ford-approved DEF.
Initial warning 10 hours after incorrect DEF quality is detected.	Amber engine solid 	Vehicle speed limited to 55 mph (88 km/h).*	
Final vehicle consequence 20 hours after incorrect DEF quality is detected and engine intentionally shut down (key off), in extended idle for one hour or fuel tank refilled.*	Amber engine solid  / Red engine solid 	Vehicle speed limited to 25 mph (40 km/h).	





*The vehicle speed restriction is suspended during pump operation when using any of the following engine control modes:

- Power take-off
- Remote power take-off
- Remote throttle
- SAE J1939-commanded pressure governor.

SCR Faults and Vehicle Consequences			
Condition	Indicator Lamps	Consequence	Remedy
No faults.	None.	None.	None.
Initial warning when fault is detected.	Amber engine solid 	None.	Correct and clear fault condition.
Initial warning one hour after fault is detected.	Amber engine solid 	25% torque reduction.	
Secondary warning five hours after fault is detected.	Amber engine solid 	Torque reduction increases from 25% to 40% at rate of 1% each minute.	
Final vehicle consequence five hours after fault is detected and engine intentionally shut down (key off), in extended idle for one hour or fuel tank refilled.*	Amber engine solid  / Red engine solid 	<ul style="list-style-type: none"> • 40% torque reduction • 5 mph (8 km/h) vehicle speed limit • 1000 RPM engine speed limit.** 	

*Refueling the fuel tank is defined as increasing the fuel volume level by 15%.

**Final consequence for vehicles equipped with a manual transmission is 1000 RPM. Final consequence for vehicles equipped with an automatic transmission is 1100 RPM.

SCR Faults and Vehicle Consequences for Emergency Vehicle			
Condition	Indicator Lamps	Consequence	Remedy
No faults.	None.	None.	None.
Initial warning when fault is detected.	Amber engine solid 	None.	Correct and clear fault condition.
Initial warning 10 hours after fault is detected.	Amber engine solid 	Vehicle speed limited to 55 mph (88 km/h).*	
Final vehicle consequence at 40 hours after fault is detected and engine intentionally shut down (key off) or in extended idle for one hour.	Amber engine solid  / Red engine solid 	Vehicle speed limited to 25 mph (40 km/h).	

*The vehicle speed restriction is suspended during pump operation when using any of the following engine control modes:

- Power take-off
- Remote power take-off
- Remote throttle
- SAE J1939–commanded pressure governor.

Filling the DEF Tank



WARNING: Make sure that DEF does not come into contact with eyes, skin or clothing. Should DEF contact your eyes, flush them with plenty of water and contact a physician. Clean affected skin with soap and water. If DEF is swallowed, drink plenty of water and contact a physician immediately.



WARNING: Refill DEF in a well-ventilated area. When opening the cap on the DEF tank or bottle containing DEF, ammonia vapors may escape. The vapors can be irritating to skin, eyes and mucous membranes. Inhaling ammonia vapors can cause burning to the eyes, throat and nose and cause coughing and watery eyes.

Note: Do not put DEF in the fuel tank or any other tank on the vehicle. This can cause damage to components not covered by your vehicle's warranty.

Your vehicle is equipped with a DEF tank with a blue-capped filler port. The 5 gallon (19.0L) DEF tank is located on the left side of the vehicle under the cab. The 9 gallon (34.0L) DEF tank is located on the right side of the vehicle behind the cab (Regular Cab and Super Cab) or under the cab (Crew Cab). The tank can be filled using a nozzle at a DEF filling station (similar to fuel fill) or using a DEF bottle with a spout. Motorcraft® brand DEF bottles are recommended. Other aftermarket bottles can be used but should have a seal on the spout and an internal vent tube to achieve best fill performance and prevent overfilling.

You can purchase DEF at your authorized dealer, most highway truck stops or you can contact roadside assistance for help in finding a retailer that sells DEF. See the *Customer Assistance* chapter for more information. Also, a government website locator is available for diesel exhaust fluid supplies. The following web address can be used to find the nearest location to purchase DEF: <http://www.afdc.energy.gov/afdc/locator/def>.

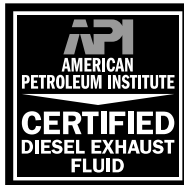

Use Motorcraft® DEF or equivalent meeting Ford specification WSS-M2C130-A and/or ISO 22241. Use only DEF certified by the American Petroleum Institute. Look for this certification trademark. Repairs resulting from the use of non-certified DEF products may not be covered by your vehicle's warranty.

Maintaining the purity of DEF is important to avoid malfunctions in the SCR system.

If DEF is removed from the tank for any reason (such as repair work), the same DEF must not be used to refill the tank as its purity is no longer guaranteed.

To fill the DEF tank, see your authorized dealer or do the following (before filling the DEF tank in cold climates, see *Filling the DEF tank in cold climates* later in this section):

DEF Bottle Fill with Spout

The following procedure applies to Motorcraft® DEF or similar DEF bottles. For other brands or bottle types, see the instructions on the bottle label.



1. Remove the cap from the DEF container and twist the spout onto the container until the locking tab is engaged.



2. Open the DEF filler port on the vehicle by turning the blue cap counterclockwise a ¼-turn.

3. Lift and hold the DEF container, without tipping, and insert the spout, into the DEF filler port.

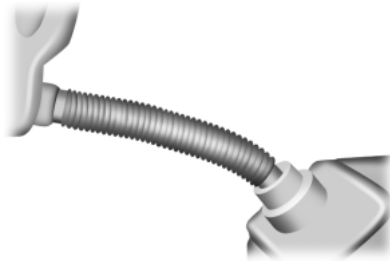

4. Lift and tip the container to let DEF flow into the tank. Pour DEF until the container is empty or DEF flow stops. DEF can be seen flowing through the spout, but does not completely fill the spout while flowing. Air is trapped in the spout while DEF is flowing. When the DEF tank is full, DEF completely fills the spout and displaces the air in the spout.

5. Once the spout is full with DEF (no more large air pockets), return the container to the vertical position slightly below the DEF filler port and let any DEF drain out of the spout. **DO NOT** try to continue to add DEF to the tank by shaking or repositioning the container to induce flow. This may cause spilling and overfill the tank. Overfilling the DEF tank can cause damage to the tank.

6. Once the spout has drained, remove the spout from the DEF filler port and install the blue cap on the DEF filler port by turning the cap clockwise a ¼-turn.

7. Remove the spout from the DEF container and install the cap back on the bottle.
8. If the container is empty, discard the empty container and spout, or recycle if possible. If there is some DEF left in the container, retain it and the spout for later use. Store the spout to make sure it is kept clean.
9. Wipe away any DEF that has spilled on painted surfaces with water and a damp cloth.

DEF Filling Station Nozzle Fill





Filling the DEF tank using a nozzle is similar to a normal fuel fill. The nozzle shuts off automatically when the tank is full. Do not continue to fill the tank as this may cause spillage and overfill the tank, which can cause damage.

Filling the DEF Tank in Cold Climates

DEF freezes below 12°F (-11°C). If temperatures are at or below 12°F (-11°C) for an extended period of time, and the DEF tank is full, and you are not going to drive the vehicle, there is a risk that the tank could freeze, causing damage. If low temperature conditions are expected, you should keep your tank at least 50% full and make sure you add DEF on level ground to prevent the fluid from freezing on an angle.

Contaminated DEF

SCR systems are sensitive to contamination of the DEF. USE ONLY CERTIFIED DIESEL EXHAUST FLUID. If the system becomes contaminated and the vehicle continues to be driven with contaminated DEF, the following warnings result:

Reducing Agent and Vehicle Consequence		
Condition	Indicator Lamps	Consequence
Correct reducing agent	None	None
Incorrect reducing agent, at detection	Amber engine 	None
Incorrect reducing agent, at detection + 10 hours	Amber engine 	40% torque reduction
Incorrect reducing agent, at detection + 20 hours and engine intentionally shut down or in extended idle	Amber engine  Red engine 	40% torque reduction + 5 mph (8 km/h) vehicle speed limit

If any of these warnings appear, the contaminated DEF must be purged and replaced with approved DEF. See an authorized dealer or the *Workshop Manual*.

Upon filling the DEF tank after a DEF contaminated warning, normal operation resumes when the vehicle is restarted.

DEF Guidelines and Information

- DEF is non-flammable, non-toxic, colorless and water-soluble.
- Use only DEF that carries the trademark: AMERICAN PETROLEUM INSTITUTE CERTIFIED DIESEL EXHAUST FLUID.
- An ammonia odor may be smelled when the cap is removed or during a refill. Refill the DEF tank in a well-ventilated area.
- Prior to filling the tank, make sure the surrounding area is clean of debris to prevent contamination.
- Do not dilute DEF with water or any other liquid.
- Do not put DEF in the fuel tank or any other tank on the vehicle.
- Do not re-use the nozzle or the DEF container once it is emptied.
- Do not overfill the DEF tank.
- Avoid spilling DEF on painted surfaces, carpeting or plastic components. Immediately wipe away any DEF that has spilled on painted surfaces with a damp cloth and water. If it has already crystallized, use warm water and a sponge.
- DEF freezes below 12°F (-11°C). Your vehicle is equipped with an automatic pre-heating system which allows the DEF system to operate below 12°F (-11°C).
- Do not store the DEF bottle in your vehicle. If it leaks, it could cause damage to interior components or release an ammonia odor inside the vehicle.
- Store DEF out of direct sunlight and in temperatures between 23°F–68°F (-5°C–20°C).

NOISE EMISSIONS

In order to comply with the federal exterior noise regulations, your vehicle may be equipped with noise emission items. Depending on the vehicle configuration, it may have all or some of the following items:

Air Intake System: Inspect the air cleaner. Do not alter its location. Do not alter inlet and outlet piping.

Body: Inspect wheel well splash shields, cab shields and underhood insulation for deterioration, dislocation and orientation.

Cooling System:

- Inspect the fan for blade damage. If damage is found, replace with the recommended parts. Inspect for fan-to-shroud interference and any damage to shroud, such as cracks and holes.
- Do not change fan ratio or alter fan spacer dimensions and positions.
- Inspect fan clutch for proper operation. Make sure the fan is disengaged when cooling of the engine is not required.
- Inspect radiator shutters (if equipped) for proper operation. The shutters should be open during normal operating temperatures.

Engine: Valve covers and block covers are made to damp-out engine mechanical noise and, if needed, should be replaced with recommended parts. Check for mechanical isolations.

Transmission Enclosure: Inspect for cracks, holes and tears. Clean any deposits, such as oil, dirt and stones.

Exhaust System:

- Inspect for leaks at various joint connections and loose clamps.
- Perform a visual inspection for cracks or holes in the muffler and tail pipe.
- Always use the recommended parts when items need to be replaced.
- Do not change the tail pipe elbow or offset tail pipe orientation from the standard position as originally received.
- To avoid abnormal changes in vehicle sound levels, it is necessary for the owner to perform inspections and necessary maintenance at the intervals shown in the *Scheduled Maintenance* chapter.

MANUAL TRANSMISSION OPERATION (IF EQUIPPED)

Manual transmission shift patterns are displayed on either the shift lever knob or the sun visor. Study this information carefully before you drive the vehicle even though you may be familiar with similar units. Do not attempt to drive the vehicle without knowing the exact shift pattern of the transmission. Consult your authorized dealer if any questions exist as to the shifting instructions posted in your vehicle.

Driving Hints

WARNING: Do not coast the vehicle with the clutch pedal pressed or with the transmission in neutral. This practice could result in loss of vehicle control.

The following driving hints are provided as a brief, general guide in operating the different manual transmissions used in your vehicle.

- When shifting into first gear or reverse with your vehicle standing still, quickly release and press the clutch pedal (if necessary to complete gear engagement).
- Always use the lowest (or most appropriate) gear to start the vehicle.
- Always use a gear ratio low enough to allow the engine to operate above the minimum engine operation speed range.
- Do not lug the engine.
- Do not slam or jerk the gearshift lever into gear.
- When more power is required, shift to a lower gear and accelerate the engine near the governed speed.

To go forward, press the clutch pedal in and shift into first gear while the engine is idling. Engage the clutch while pressing the accelerator to start forward. Operate the clutch and upshift as required by driving conditions.

To go backward, put the gearshift lever in reverse and engaging the clutch while pressing lightly on the accelerator.

Shifting with a Synchronized Transmission

With the clutch pedal pressed in, use the second gear synchronizer to stop the clutch disc rotation; this allows smooth engagement of first gear or reverse. To complete the gear engagement, it may be necessary to apply light pressure to the gearshift lever during initial engagement of the clutch. It takes a second or two to match gear speeds; steady pressure on the gearshift lever helps the synchronizer perform its job more quickly. If the gearshift lever is forced into position, this action defeats the purpose of the synchronizer by causing gear clash.

Shifting with a Non-Synchronized Transmission

See *Clutch brake* and *Double clutch procedures* in the *Clutch* section of this chapter.

Clutch

Do not ride or slip the clutch as this causes unnecessary heat and wear. Maintain the specified clutch adjustment to prolong its life and regularly inspect the clutch control linkage for tightness. See the *Scheduled Maintenance* chapter for other maintenance information. When adjustment of the clutch is necessary, it is very important that the work be performed properly or early clutch failure may result and a costly clutch overhaul may become necessary. Clutch work should only be performed by a qualified technician.

Note: Continued use of a damaged or worn clutch, prolonged clutch slippage or downshifting at excessive speeds can result in a failure of the engine, transmission or clutch components.

Note: To avoid premature clutch wear and failure, do not drive with your foot resting on the clutch pedal or use it to hold the vehicle at a standstill on an upgrade as when waiting for a traffic light.

Engaging the Clutch

- **Always start in the proper gear.** An empty vehicle can start in a higher gear than a fully-loaded vehicle. Starting in too high a gear can cause clutch slippage and excessive heat and wear on the clutch. A gear that starts the vehicle moving at idle speed is the correct gear. If the engine has to be revved to get the vehicle going, the gear selection is too high.
- **Do not shift until the vehicle has reached the proper speed.** Upshifting before the vehicle has reached the proper speed can cause clutch slippage and excessive heat and wear on the clutch.
- **Never hold a vehicle on a grade with the clutch.** This causes the clutch to slip and can actually burn up the clutch.
- **Never coast with the clutch disengaged.** The high RPM (sometimes over 10000) can actually burst the facing material of the clutch.
- **Never engage the clutch while coasting.** Re-engaging the clutch after coasting may not only cause a great shock to the clutch, but the whole drivetrain. Internal engine damage or clutch and flywheel failure can result from this.

If the transmission is equipped with a ceramic clutch, you must start the vehicle moving in first gear and engage the clutch before pressing the accelerator at idle. Also, do not try to slip the clutch by raising engine RPM and riding or feathering the clutch pedal since this causes erratic engagement which can cause engine stalling and potential serious damage to driveline components.

Clutch Brake (Non-Synchronized Transmissions) - Vehicle Stationary

A clutch brake is used to stop transmission input shaft rotation so that the initial first gear or reverse gear selection can be accomplished when the vehicle is stationary and the engine is at idle speed. Clutch brake application occurs in the last inch (25 millimeters) of clutch pedal travel.

When using the clutch brake, fully press the clutch pedal and shift the transmission into first gear or reverse. If the transmission won't go into one of these gears, slowly release the clutch pedal while applying light pressure on the transmission shift lever until it shifts into gear.

Note: After engagement of first gear, **do not** use the clutch brake for upshifting or downshifting. If you do, clutch brake life shortens and gear selection shift efforts may increase.

Double-Clutch Procedures - Non-Synchronized Transmissions

In order to properly upshift or downshift:

1. Press the clutch pedal to disengage the clutch.
2. Shift the transmission into neutral.
3. Release the clutch pedal.

If upshifting, wait until the engine speed matches the transmission speed of the gear you are selecting.

If downshifting, accelerate the engine until the engine speed matches the input speed of the gear you are selecting. Press the clutch pedal immediately and shift into the desired gear, then release the clutch pedal.

Eaton FS-5205A 5-speed

This transmission is equipped with five forward gears and one reverse; gears 2-5 are synchronized. The shift pattern is embossed on the gear shift knob.

Do not shift the transmission into reverse while the vehicle is moving as this could damage the transmission.

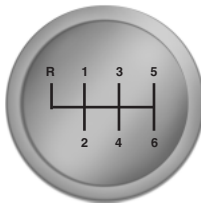
Eaton FS-5406A, FS-5406N, FS-6406A and FSO-6406A 6-speed

These transmissions are equipped with six forward gears and one reverse; all forward gears are synchronized. The shift pattern is embossed on the gear shift knob.

Do not shift the transmission into first gear or reverse while the vehicle is moving as this could damage the transmission.

Spicer ES56-7B and ES066-7B 7-speed

These transmissions are equipped with seven forward gears and one reverse; gears 2-7 are synchronized. The shift pattern is embossed on the gear shift knob.

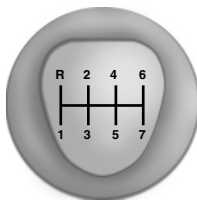

Do not shift the transmission into first gear or reverse while the vehicle is moving as this could damage the transmission.

AUTOMATIC TRANSMISSION OPERATION (IF EQUIPPED)

WARNING: Hold the brake pedal down while you move the gearshift lever between positions. If you do not hold the brake pedal down, your vehicle may move unexpectedly and cause property damage, personal injury or death.

Main transmission, auxiliary transmission, transfer case and power take-off (PTO) control shift patterns can be found on a placard or decal on the driver's sun visor, on the instrument panel or on the shift control itself.

The main transmission control is used to select the various gear ratios or speeds of the transmission. Selecting position **D** does not change the transmission gear ratio, but is used where the gear ratios in the main transmission are adequate to handle the vehicle operation.

If the transmission fails to shift properly, check the inline 10A fuse located in the battery cables above the battery.

Brake-shift Interlock

Vehicles equipped with a gasoline engine have a brake-shift interlock feature that prevents the gearshift lever from being moved from position **P** when the ignition is in the on position and the brake pedal is not pressed.

If you cannot move the gearshift lever out of position **P** with the ignition in the on position and the brake pedal pressed, it is possible that a fuse has blown or the vehicle's brake lamps are not operating properly. See the *Fuses* chapter.



WARNING: Do not drive your vehicle until you verify that the brake lamps are working.



WARNING: When doing this procedure, you will be taking the vehicle out of park which means the vehicle can roll freely. To avoid unwanted vehicle movement, always fully set the parking brake prior to doing this procedure. Use wheel chocks if appropriate.

 **WARNING:** If the parking brake is fully released, but the brake warning lamp remains illuminated, the brakes may not be working properly. See your authorized dealer.

If the fuse is not blown and the brake lamps are working properly, the following procedure allows you to move the gearshift lever from position **P**:

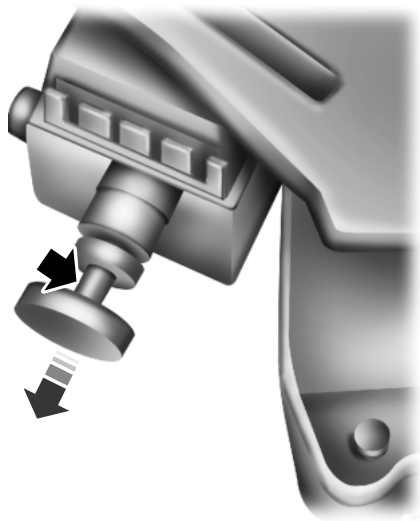

1. Apply the parking brake, and turn the engine off.
2. Remove the lower finish panel below the steering column.
3. Turn the key to the on position, but do not start the engine.
4. Pull back on the solenoid, and at the same time, shift the transmission into position **N**.
5. Start the vehicle.

See your authorized dealer as soon as possible if this procedure is used.

Six-speed TorqShift® Transmission

 **WARNING:** Always set the parking brake fully and make sure the gearshift is latched in position P. Turn the ignition to the off position and remove the key whenever you leave your vehicle.

 **WARNING:** Do not use the tow/haul feature when driving in icy or slippery conditions as the increased engine braking can cause the rear wheels to slide and the vehicle to swing around with the possible loss of vehicle control.

P	R	N	D	4	2	1
---	---	---	---	---	---	---

Position P

This position locks the transmission and prevents the rear wheels from turning.

To put your vehicle in gear:

1. Start the engine.
2. Press the brake pedal.
3. Move the gearshift lever into the desired gear.

To put your vehicle in position **P**:

1. Come to a complete stop.
2. Move the gearshift lever and securely latch it in position **P**.

Position R

With the gearshift lever in position **R**, the vehicle moves backward. Always come to a complete stop before shifting into and out of position **R**.

Position N

With the gearshift lever in position **N**, the vehicle can be started and is free to roll. Hold the brake pedal down while in this position.

Position D

This is the normal driving position for the best fuel economy. This position allows automatic upshifts and downshifts in gears one through six.

Position 4

This position allows automatic upshifts and downshifts in gears one through four.

Position 2

Use position **2** to start-up on slippery roads or to provide additional engine braking on downgrades.

Position 1

- Provides maximum engine braking.
- Allows upshifts by moving gearshift lever.
- The transmission does not downshift into position **1** at high speeds; it downshifts to a lower gear and then shifts into position **1** when the vehicle reaches slower speeds.

Forced Downshifts

- Allowed in position **D**.
- Press the accelerator to the floor.
- Allows transmission to select an appropriate gear.

Allison 2200 with Parking Pawl Feature

Note: Also see the separate *Allison Transmission Operator's Manual*.



WARNING: Always set the parking brake fully. Do not use the gearshift in place of the parking brake.



WARNING: To avoid sudden, unexpected vehicle movement and possible personal injury or death:

1. Bring the vehicle to a complete stop.
2. Shift the transmission into position **P**. Slowly lift your foot from the brake pedal to engage the transmission parking pawl mechanism.
3. Apply the parking brake and make sure it is holding properly. Do not rely solely on the parking mechanism of the transmission.
4. Turn the engine off when you leave the vehicle. **Never leave the vehicle unattended when the engine is running.**

A parking pawl effectively grounds the transmission's output shaft preventing rotation of the driveline. If the vehicle is stationary, selecting position **P** places the transmission in neutral and engages the parking pawl. Always use the parking brake when parking the vehicle.

Note: If position **P** is selected when the vehicle is in motion, the parking pawl mechanism ratchets and **DOES NOT** hold the truck.

Allison 2500

WARNING: To avoid sudden, unexpected vehicle movement and possible personal injury or death:

1. Bring the vehicle to a complete stop.
2. Shift the transmission into position **N**.
3. Apply the parking brake and make sure it is holding properly.
4. Turn the engine off when you leave the vehicle. **Never leave the vehicle unattended when the engine is running.**

This transmission is available with a column-mounted gearshift lever. The gear positions are displayed on the RNDL in the instrument cluster.

Allison 3000

Note: For more information regarding this transmission, see the separate *Allison 3000 Series Operator's Manual*.

The Allison 3000 series offers two shift modes: Performance and Economy.

Performance mode gives the best all-around transmission operation. The transmission defaults to this mode when you start the engine. Pressing MODE on the shifter switches to Economy mode and illuminates the Mode ON lamp.

Economy mode provides operation at lower engine RPM while maintaining adequate performance.

If the engine speed is above idle when a gear is selected using the shifter, the vehicle does not move; the shifter must be moved to re-select a gear after the engine speed returns to idle.

Torque Lock

If your vehicle is parked on an incline and position **P** is not properly engaged (the parking brake is not applied before the transmission is shifted into position **P**), the weight of the vehicle may generate an excessive amount of torque on the parking pawl, making it difficult to shift the transmission out of position **P**. Hold the brake pedal down while shifting out of position **P**, then release the parking brake.

Allison 3000 Series Push-Button Shifter

To shift to Reverse or Drive:

1. Press the brake pedal.
2. Press R or D on the shifter.
3. Release the brake pedal.

To select a higher range when in Drive, press the up arrow button.

To select a lower range when in Drive, press the down arrow button.

To place the transmission in Neutral, press N.

Allison 3000 Prognostics

This transmission is equipped with the Allison Prognostics feature that can alert the driver to needed transmission maintenance and transmission fluid and filter life. See the separate Allison transmission manual for complete details.

POWER TAKE-OFF (PTO) OPERATION (IF EQUIPPED)

A PTO unit allows the transmission to power auxiliary equipment to run devices such as snowplows, aerial lifts, tow truck lifts, cement mixers or dump trucks.

Vehicles Equipped with an Allison Automatic Transmission (Except 3000 Series)

The PTO can be operated while the vehicle is standing or moving. To engage the PTO, apply the brakes and shift to any gear other than position **N**, then engage the PTO.

If engagement is prevented by the gear teeth not meshing properly, release the brakes and allow the vehicle to creep slightly or shift the

selector to position **N** and then back into gear. The PTO should never be engaged by clashing the gear teeth. This may damage the PTO unit and the transmission PTO drive gear teeth, resulting in further damage to the transmission and PTO.

PTO Operation with Vehicle Stationary



WARNING: When the PTO is operated with the vehicle stationary, the transmission must be placed in position **N** with the parking brake set. If the transmission is not in position **N** and is equipped with a remote throttle control, an increase in engine speed can overpower the parking brake and cause the vehicle to move, possibly resulting in personal injury and/or property damage.

Stop the vehicle, idle the engine and set the parking brake. Make sure the gear selector is in any forward drive range, then engage the PTO. After the PTO is engaged, move the range selector to position **N**. Increase the engine speed until the desired PTO operation speed is obtained. To disengage the PTO after operation with the vehicle standing, release the throttle, allow the drive equipment to come to a stop, and then disengage the PTO.

PTO Operation while Vehicle Is Moving

After the PTO is engaged for driven vehicle operation, shift to the desired range and drive the vehicle. The speed of the PTO, during this period of operation, always maintains direct relation to vehicle speed. PTO speed decreases in relation to vehicle (transmission output) speed as shifts to a higher gear occur. When operating the PTO while the vehicle is moving, the PTO may be disengaged whenever it is no longer required. When there is no load on the PTO gear, it can be pulled out of engagement.

Vehicles Equipped with an Allison 3000 Series Automatic Transmission

The PTO drive gear is engine-driven and provides direct engine power. The PTO can be operated when the vehicle is either stationary or moving. The PTO gear is in constant mesh with the drive gear in the torque converter housing. A friction clutch or constant drive is used to transmit power to the PTO.

Vehicles Equipped with a Manual Transmission

Transmission-mounted PTO units are available for local installation on your vehicle. See your *Body Builder's Layout Book* for restrictions on use and installation of PTO units.

To engage the PTO unit, stop the vehicle and place the transmission in position **N**. Press the clutch and allow the gears to stop rotating, then engage the PTO unit. The PTO can also be selected with the transmission in gear as long as the clutch is pressed.

When operating the PTO with the vehicle stationary, first set the parking brake (chock the wheels if the vehicle is on a hill or another uneven surface).

REAR AXLES

Gross Axle Weight



WARNING: Exceeding these ratings by overloading can cause component failure resulting in property damage, personal injury or death.

Your truck has gross axle weight, gross vehicle weight and gross combination weight ratings. Do not exceed these ratings.

Locking or Limited-Slip Differentials



WARNING: If both wheels are not raised off the ground, the one wheel that is not raised may pull the vehicle off its support, possibly resulting in personal injury

If your vehicle is equipped with a locking or limited-slip differential, note the following:

- Power is transmitted to the opposite wheel should one of the wheels begin to slip.
- Both wheels must be raised off the ground should it be necessary to operate one wheel with the vehicle stationary.

Driver-controlled Differential Lock

Note: Never use the differential lock at vehicle speeds above 25 mph (40 km/h).

Some drive axles have a driver-controlled differential lock. The differential lock can lock or unlock the differential when the vehicle is moving or stopped. When extra traction is required, the differential lock provides full power to both axles.

When the differential is locked, the vehicle's turning radius increases (under-steer).

The differential can be locked or unlocked when the vehicle is moving at a constant speed of under 25 mph (40 km/h) and while the wheels are not slipping. The differential must not be locked when the vehicle is traveling down steep grades and traction is minimal.

The differential lock and differential lock light automatically disengage at speeds above 25 mph (40 km/h). The differential lock remains off until either the vehicle is restarted or the differential lock switch is turned off then back on.

Turn the engine off and raise all drive wheels of the locker differential axle in order to prevent the vehicle from moving when servicing the wheels, tires or brakes. Axles equipped with a NoSPIN Detroit Locker differential deliver power to both wheels even when only one wheel is on the ground.



WARNING: Failure to raise all drive wheels with this type of differential could cause the vehicle to move unexpectedly, resulting in property damage, personal injury or death.

Care should be taken to avoid sudden accelerations when both drive wheels are on a slippery surface.



WARNING: Sudden accelerations on slippery surfaces could cause the wheels to spin, the vehicle to turn sideways on a crowned road surface or in a turn, possibly resulting in loss of vehicle control and personal injury.

Fluid Temperature

Axle operating temperatures normally do not exceed 100°F (38°C). If the operating temperature exceeds 230°F (110°C), the rate of axle lubrication oxidation increases and shortens the life of the lubricant and seals, requiring axle lubrication changes to become more frequent to preserve the axle. Extreme Pressure (EP) lubricants should not be run consistently above 230°F (110°C).

Axle Conversions



WARNING: When operating a loaded vehicle, the driver must keep all adjustable axles on the ground at all times, supporting their share of the vehicle's load. Failure to do so can overload other axles, tires, wheels, springs, steering components, brakes and frames, resulting in early component failure, loss of vehicle control, possible property damage and personal injury.

It is not recommended, or approved, for axle conversions to be performed. However, it is understood that, on occasion, aftermarket add-on axles are installed by others on the truck chassis which allow operator control for weight transfer from other axles (i.e., air lift axles).

TWO-SPEED REAR AXLE (IF EQUIPPED)



WARNING: Never shift a two-speed axle when descending a steep grade as this may cause loss of vehicle control and result in personal injury.

Note: Do not shift between ranges when the speed control is on.

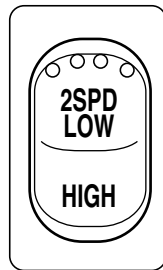

A two-speed rear axle allows the driver to select a low range for greater pulling power and a high range for greater road speed and fuel economy. These ranges can also be used to provide additional steps between transmission shifts when driving on steep grades or fuel economy may be factors.

Axle Shifting with a Manual Transmission

To downshift, select the next lower gear, release and press the accelerator pedal rapidly, or while holding the accelerator pedal down, release and engage the clutch rapidly. **Note:** The clutch method is recommended when driving at slower speeds.

To upshift, keep the accelerator pedal down, select the next higher gear, release the accelerator and pause until the axle upshifts. **Note:** De-clutch for smoother axle upshifts when driving at slower speeds.

Axle Shifting with an Automatic Transmission

Note: You cannot split-shift with an automatic transmission. Also, downshifting above 40 mph (64 km/h) may result in transmission or axle damage.

Note: Do not shift the axle to LOW with the vehicle in motion.

Use LOW when you drive a fully-loaded vehicle on a severe grade or in congested traffic. Press the upper portion of the switch.

Use HIGH for all normal driving conditions with a lightly-loaded or partially-loaded vehicle. Press the lower portion of the switch.

To shift the axle from LOW to HIGH with the vehicle stopped, place the transmission in position **N**, then press the lower part of the switch.

To shift the axle from LOW to HIGH with the vehicle moving, accelerate to approximately 35 mph (56 km/h), press the lower part of the switch while the transmission is in position **N**, then release and apply the accelerator.

To shift the axle from HIGH to LOW with the vehicle stopped, place the transmission in position **N**, then press the upper part of the switch.

Split-shifting (Combined Axle and Transmission Shift) (Manual Transmission Only)

To downshift the axle to a slower ratio and shift the transmission, shift the transmission and move the switch to the lower ratio before the clutch is re-engaged.

To upshift the axle and shift the transmission, move the switch to a faster ratio and make the transmission shift in the usual manner.

Split-shift Sequence											
Ratio combination	1	2	3	4	5	6	7	8	9	10	11
Transmission gear	1st	1st	2nd	2nd	3rd	3rd	4th	4th	5th	6th	6th
Axle range	LO	HI	LO	HI	LO	HI	LO	HI	LO	LO	HI

Ratio Extender Use

Low end: A two-speed axle can be used as a ratio-extender when split-shifting is not necessary. For low end use, just shift the axle into LOW to start out, and shift to HIGH when the extra torque is no longer needed.

Transmission (5-speed)	1st	1st	2nd	3rd	4th	5th	6th
Two-speed axle	Axle low		Axle high				

High end: To use the two-speed axle as a high end ratio-extender, stay in the LOW range for normal upshifts and only shift the axle to HIGH on the freeway for greater road speed.

Transmission (5-speed)	1st	2nd	3rd	4th	5th	6th
Two-speed axle	Low for gradeability				Axle high	

GENERAL INFORMATION

All standard equipment brakes are designed to be self-adjusting. Automatic adjustment, when required, occurs whenever the brakes are applied and released during forward or reverse operation.

Note: Occasional brake noise is normal. If a metal-to-metal, continuous grinding or continuous squeal sound is present, the brake linings may be worn out and should be inspected by an authorized dealer. If the vehicle has continuous vibration or shudder in the steering wheel while braking, the vehicle should be inspected by an authorized dealer.

Know the required stopping distances for all driving conditions that may be encountered. For longer brake lining life, take full advantage of engine braking power when coming to a stop.



WARNING: Do not drive with your foot resting on the brake pedal. This results in abnormally high brake temperatures, excessive lining wear and increased stopping distances.

Before descending a long or steep hill, shift to a lower gear and avoid continuous application of the brakes. Normally, choose the same gear to descend the hill that you use to ascend the hill.



WARNING: Continuous application of the brakes causes the brakes to overheat, resulting in a temporary loss of braking.



See the *Instrument Cluster* chapter for information on the brake system warning light.

Wet brakes result in reduced braking efficiency. Gently press the brake pedal a few times when driving from a car wash or standing water to dry the brakes.

If Brakes Do Not Grip Well

- If you have been driving through deep water, gently apply the brakes several times while the vehicle is moving slowly.
- Let the brakes cool if you have been using them excessively, as in mountain driving or after several fast, high-speed stops.
- Check brake adjustment.
- Check brake linings for excessive wear.
- Check system air pressure on vehicles equipped with air brakes.

Anti-lock Brake System (ABS)

This system helps you maintain steering control during emergency stops by keeping the brakes from locking.



The ABS lamp momentarily illuminates when the ignition is turned on. If the light does not illuminate during start-up, remains on or flashes, the ABS may be disabled and may need to be serviced.



If the ABS is disabled, normal braking is still effective. If the brake warning lamp illuminates, have your brake system serviced immediately.



If a PLC trailer is connected when the ignition is switched on, the trailer ABS light also illuminates. If the light fails to illuminate, remains on after the vehicle is started or continues to flash, have the system serviced immediately.

FULL POWER BRAKE SYSTEM

WARNING: If the red BRAKE warning lamp in the instrument cluster remains illuminated after engine start up, this indicates a system failure in the Full Power Brake System. Stop the vehicle safely as soon as possible and seek service immediately.

This system incorporates standard braking, an anti-lock braking system (ABS) and optional Power Park Brake into one fully-integrated hydraulic brake system. With the Full Power Brake System, braking energy is stored, similar to an air brake system, resulting in faster response times and shorter stopping distances. This is accomplished using motor and pump assemblies that pressurize the system by pumping brake fluid into accumulators. This is similar to the air compressor of an air brake system pressurizing the air tanks. The system includes a master cylinder that provides the normal pedal feel and transfers the pedal force, via brake fluid, to the main components of the system.

Note: The motor and pumps run momentarily with the ignition switch in the on or run position, or in the off position with the brake pedal pressed.

Note: During normal driving, the pump and motors may be heard replenishing the accumulators. This is a normal function of the system.

AIR BRAKES

After starting the engine, give the air compressor time to build up the air pressure to 60 psi (414 kPa) before moving the vehicle.



WARNING: Do not drive or continue to drive if the low air pressure buzzer is sounding or the brake warning light is lit. These warnings indicate that air pressure is not to normal operating level. Continued use of the vehicle could result in loss of braking ability.



WARNING: Avoid repeated light application of the brake pedal. This depletes air pressure faster and could result in loss of braking capability.



Periodically check the air pressure gauge while driving. Pressure should range between approximately 100–125 psi (690–862 kPa). The air compressor governor cut-in and cut-out pressure settings are set at the factory and are not adjustable.



When air pressure is insufficient (below 60 psi [414 kPa]), a warning light illuminates and a buzzer sounds when the ignition is in the on position.

This condition may be caused by excessive brake applications depleting the system air pressure. If this condition occurs, stop driving the vehicle until the compressor has fully recharged the air system.



WARNING: Do not move the vehicle when the air pressure is insufficient because the brake system may be inoperative.

Select a gear ratio to help slow your vehicle before descending grades. Supplement with brakes as required to safely slow the vehicle and avoid overspeeding the engine.

Air Chamber Stroke Indication

Air chamber push rods have orange stroke indicator markers that warn when the braking system requires adjustment or repair. The orange stripe is painted on the air chamber push rod at the slack adjuster stroke dimension which requires service when visible during brake application.

Air brake inspection and adjustment or repairs should be performed by a qualified service technician in accordance with the instructions in the service manual.

Cam Brakes - Automatic Slack Adjusters

 **WARNING:** Do not manually adjust the automatic slack adjusters to correct excessive push rod stroke as it may result in reduced brake effectiveness and a vehicle crash. Excessive push rod stroke indicates that a problem exists with the automatic adjuster, with the installation of the adjuster, or with foundation brake components that manual adjustment does not remedy. Seek service from a qualified facility for excessive push rod stroke.

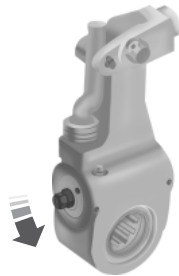

Standard air brakes (cam) are equipped with automatic brake adjusters. Automatic adjustment occurs during brake applications. Inspect brakes for proper adjustment at the intervals listed in the *Scheduled Maintenance* chapter.

Emergency Air Brake

 **WARNING:** Do not continue to operate the vehicle with a failure of one of the brake systems. Take the vehicle to your dealer for service immediately.

All vehicles are equipped with a dual brake system. In the unlikely event of a failure of one system, the second system functions for emergency stopping. These systems are all controlled by the brake pedal in the same manner as for normal stops.

HINTS ON DRIVING WITH ANTI-LOCK BRAKES

When the system is operating, the brake pedal pulses and may travel further. Maintain pressure on the brake pedal. You may also hear a noise from the system. This is normal.

The ABS does not eliminate the dangers inherent when:

- You drive too closely to the vehicle in front of you.
- Your vehicle is hydroplaning.
- You take corners too fast.
- The road surface is poor.

EXHAUST BRAKE (IF EQUIPPED)

WARNING: The exhaust brake is not recommended for use on slippery or low traction road surfaces. Under these conditions a loss of vehicle control could occur.

Note: Installing an exhaust or auxiliary brake does not necessarily protect the engine from exceeding maximum governed speed. The primary brakes should be used to make sure the engine never exceeds maximum governed speed under any conditions.

Note: Before starting the engine, make sure that the exhaust brake switch is pushed down to the off position. Do not turn the exhaust brake on until the engine has reached normal operating temperature.

Note: Maximum exhaust brake performance is related to the type of transmission your vehicle is equipped with.

Note: Engine speed has a major influence of retarding performance. When engine speed is maintained at the maximum allowable level, the exhaust brake operates at peak performance.

Note: Manual transmissions should be downshifted to the lowest gear possible, without exceeding the maximum RPM limit of the engine. This maximizes the exhaust brake's retarding effect.

Note: Exhaust brakes operate effectively with automatic transmissions, but performance varies with engine speed and the gear selected by the transmission.

An exhaust brake is an auxiliary braking system that assists, but does not replace, the primary service brake system. It is intended to help control vehicle speed. It is not a vehicle stopping device.



A switch on the instrument panel, in combination with the accelerator and clutch pedal, allows the operator to make maximum use of the exhaust brake in the following conditions:

- off-highway driving
- mountain driving
- heavy traffic
- high-speed highway driving.

To operate the brake, push the switch up to turn it on. Push the switch down to turn it off.

While approaching a steep grade, make sure that the exhaust brake switch is in the on position. The exhaust brake begins working as soon as you remove your foot from the accelerator pedal.

Before descending a hill or steep grade, always select the proper gear. If the transmission is taken out of gear while descending, it is possible that you cannot select another gear because of maximum RPM being governed.

Make sure the engine speed does not exceed the maximum allowable engine RPM. Exceeding the maximum allowable engine RPM can result in damage to the engine. Apply the service brakes to reduce the engine RPM or make a slower descent by using a lower gear.

While going down the grade, use a low enough gear to descend safely with a minimum application of the service brakes. As a general guideline, use the same gear as you use to ascend the hill.

Exhaust Brake Operating Characteristics

When you remove your feet from both the accelerator and clutch pedals and the exhaust brake switch is in the on position, the exhaust brake is activated. The following conditions exist if the brake is operating properly:

- A slight change in engine sound when the exhaust brake is activated.
- A smooth braking effect. Do not expect a retarding effect similar to sudden, hard application of the service brakes.
- The retarding force possibly felt acting against your body when the brake is applied (depending on the grade and vehicle load). This force is actually preventing the vehicle from going much faster.
- Engine temperature remaining in the normal operating range.
- The tachometer showing a drop in engine RPM (depending on grade and vehicle load) during a descent.
- A decrease in road speed when the exhaust brake is applied during a descent, except when the vehicle is carrying a heavy load or the grade is extremely steep. In these instances, you may need to apply the service brakes occasionally.

TRAILER BRAKES

Trailer Brake Hand Control (If Equipped)



WARNING: The hand control should never be used to apply the brakes when the tractor and trailer are parked unattended. Air may leak from the system and the vehicle could possibly move, resulting in possible property damage, personal injury or death.

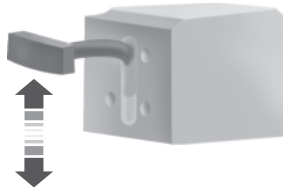

The hand control is located on the right-hand side of the instrument panel. It is used to apply the trailer service brakes which are independent of the truck or tractor service brakes.

It operates a valve that provides gradual control of air pressure applied. When the valve is only partially applied, the trailer brakes can be overridden by pressing fully on the brake pedal.

To apply the trailer brakes using the hand control, move the lever downward. The further the lever is pushed down, the greater the air pressure is applied to the brakes. The lever remains in place until manually moved.

To release the trailer brakes, move the lever up completely.

Trailer Air Supply and Parking Brake Modular Controls (If Equipped)



The trailer air supply valve delivers air to the trailer supply and automatically pops out, shutting off the trailer supply, if pressure decreases to approximately 35 psi (249 kPa).



The parking brake controls the spring brakes on the tractor. When the knob is pulled out, it causes the trailer supply valve to pop out, applying both the tractor and trailer parking brakes. The trailer brakes may be independently released by pushing only the trailer air supply valve in.

Initial Charge

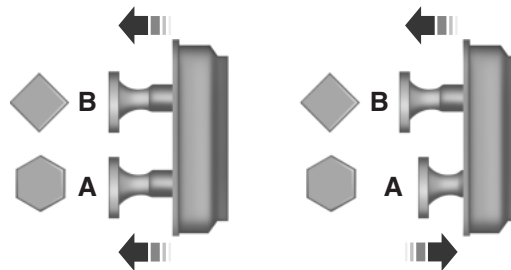

With the air system completely discharged, both knobs (A and B) are out. When the air pressure reaches 70 psi (483 kPa), the trailer air supply (A – red knob) may be pushed in and should stay in, charging the trailer air system and releasing the trailer brakes.

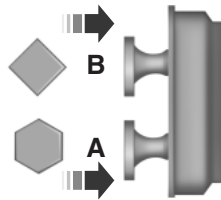

The parking brake (B – yellow knob) can now be pushed in and supply air to the tractor spring brakes, releasing them.

Normal Driving Position

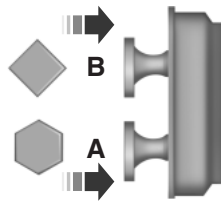

With both knobs pushed in, air is supplied to both trailer and tractor spring brakes and all brakes are released.

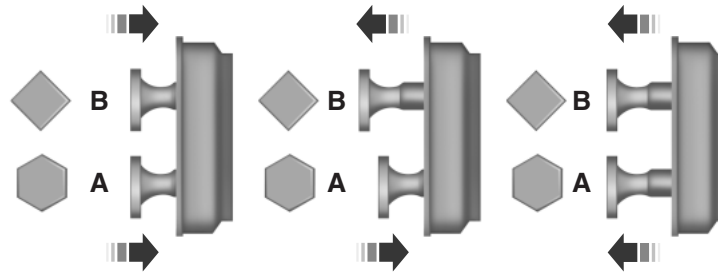
System Park

With both knobs pushed in (normal driving position), the parking brakes for both the tractor and trailer can be applied by pulling the parking brake knob (B) out, exhausting air from the tractor spring brakes, simultaneously causing the trailer air supply valve to pop out, applying the trailer brakes.

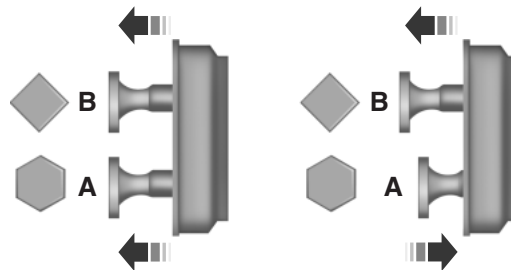
Trailer Charge

If both knobs are out, and you want to recharge the trailer while leaving the tractor spring brakes applied, the trailer air supply (A) can be pushed in to recharge the trailer air supply line. This mode may also be used to park a combination vehicle with tractor spring brakes.

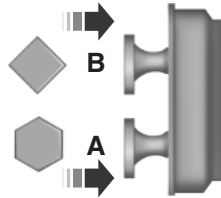
Automatic Application

If both knobs are pushed in and the brake system air pressure is reduced to approximately 35 psi (249 kPa), the trailer air supply (A) knob automatically pops out applying the emergency or parking brakes on the trailer. If the trailer air supply (A) knob is manually held in and the air pressure is reduced to approximately 30 psi (207 kPa), a tripper piston within the valve moves, exhausting the trailer air supply, applying the trailer brakes. Further reduction of air pressure, while holding the trailer air supply knob in, causes the parking brake knob to pop out at 25 psi (172 kPa).

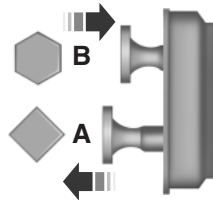
Actuation of Trailer Park (Emergency) or Tractor Bobtail Position

To actuate the trailer brakes only, pull out the trailer air supply knob (A). The trailer brakes are now applied whether emergency or spring brakes are used on the trailer.

This mode is also used when the tractor or truck with trailer is used during bobtail operation.

PARKING BRAKE**Hydraulic Brakes**

WARNING: Do not use the gearshift selector in place of the parking brake. Always set the parking brake fully AND make sure the gearshift selector is in position **R** for vehicles equipped with a manual transmission or position **P (if equipped)** or **N** for vehicles equipped with an automatic transmission. Use of wheel chocks is also recommended in hilly or off-road usage. Unexpected and possible sudden vehicle movement may occur if these precautions are not taken.



WARNING: If the parking brake is fully released but the parking brake warning lamp remains illuminated, the brakes may not be working properly. See your dealer or a qualified service technician.

Apply the parking brake whenever the vehicle is parked. To set the parking brake, pull the handle up until it snaps into the locked position.

When the parking brake is out of adjustment, seek service immediately.



The parking brake warning lamp in the instrument cluster illuminates, and remains illuminated (when the ignition is turned on), until the parking brake is released.

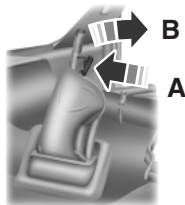

Push the palm release lever (A) on the parking brake handle (B) and push down as far as possible to release the brake. Driving with the parking brake on causes the brakes to wear out quickly and reduces fuel economy.

The parking brake is not recommended to stop a moving vehicle. However, if the normal brakes fail, the parking brake can be used to stop your vehicle in an emergency. Since the parking brake only applies retardation to the rear wheels, the vehicle's stopping distance increases greatly and the handling of your vehicle is adversely affected.

Power Park (Hydraulic Brake Vehicles Only)

This feature uses a brake chamber mounted on the chassis to power a spring-applied, hydraulically-released driveline parking brake.

The Power Park Brake is controlled by the park brake dash-mounted, yellow knob-type switch. The switch has three positions: apply (out), neutral (central), and release (in). The switch is spring-loaded to return to the neutral (central) position after being pushed or pulled.



There is no visual indication at the knob that the park brake is applied or released; check the instrument cluster. If the light is illuminated, the parking brake is applied.

Applying the Parking Brake

Pull the yellow, dash-mounted parking brake knob. The parking brake light illuminates indicating that the parking brake has been successfully set.

Note: If the light blinks and a warning chime sounds when the control knob is pulled, the parking brake is not functioning properly. Seek immediate service from your dealer. See *Parking brake warning system* in this section.

Releasing the Parking Brake



WARNING: Hold the brake pedal down while moving the gearshift lever from position to position. If the brake pedal is not held down, the vehicle may move unexpectedly resulting in property damage, personal injury or death.

Note: Read and understand the following steps and perform them whenever you prepare to drive the vehicle.

Note: The parking brake does not disengage unless sufficient system air pressure is available.

If your vehicle is equipped with a dash-mounted push button (Allison 3000 Series) or steering column-mounted (Allison 2200 and 2500) gear selector:

1. Press and hold the service brake pedal while the engine is running.
2. Select the appropriate drive gear.
3. Push and hold the yellow, dash-mounted parking brake knob until the parking brake light turns off, then release.

If your vehicle is equipped with a manual transmission:

1. Press and hold the service brake pedal while the engine is running.
2. Press and hold the clutch pedal.
3. Select the appropriate drive gear.
4. Push and hold the yellow, dash-mounted parking brake knob until the parking brake light turns off, then release.

Parking Brake Light Illumination Due to Low Air Pressure

If at any time during vehicle operation air pressure becomes too low, the parking brake may apply and the parking brake light turns on.

If the parking brake is applied due to low air pressure, immediate service is required to the parking brake system.

Parking Brake Warning System

If the parking brake light blinks and a chime sounds when pulling the yellow control knob out, this indicates the parking brake is not functioning properly. Seek service for the parking brake immediately.

With the ignition key not in the run position:

- A chime sounds if the parking brake remains released (or in an unknown state). The chime stops in approximately eight minutes or until the parking brake is applied. Seek service for the parking brake immediately.

Diesel engines: Parking brake light operation (the light only works when the ignition key is in the run position):

- **On:** Parking brake applied.
- **Off:** Parking brake released and no faults or malfunctions.
- **Blink and chime:** Parking brake released (or in an unknown state) and faults or malfunctions exist.

Releasing Spring Manually

WARNING: Do not attempt to disassemble the parking brake chamber under any circumstances. The high spring load may cause serious injury.



WARNING: Block the wheels to help prevent the vehicle from moving.



WARNING: Unexpected and possibly sudden vehicle movement may occur if these precautions are not taken.

If hydraulic pressure is released from the spring brake chamber the power spring applies the brake and, unless hydraulic pressure can be re-established, the spring brake must be released as follows in order to move the vehicle.

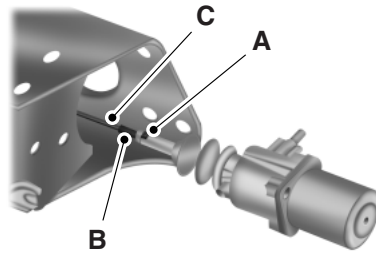

Loosen the jam nut (A) and un-thread the adjustment rod (B) from the chamber to reduce tension on the cable (C). Continue to un-thread the adjustment rod all the way and remove it from the chamber. The nut and shaft are metric.

Air Brakes

! **WARNING:** Do not use the gearshift selector in place of the parking brake; unexpected and possible sudden vehicle movement may occur if these precautions are not taken. Always set the parking brake fully AND make sure the gearshift selector is in position **R** for vehicles equipped with manual transmission or position **N** (except Allison 2200 transmission) or **P** (Allison 2200 transmission) for vehicles with automatic transmission.

If the service brakes should fail to operate while the vehicle is in motion, you can make an emergency stop with the parking brake. Since the parking brake only applies stopping power to the rear wheels, the vehicle's stopping distance greatly increases and the handling of the vehicle is adversely affected. Repairs should be made immediately to an inoperative air brake system circuit.

! **WARNING:** This control is used for parking only. Do not leave the vehicle unattended after setting the parking brake without placing the transmission in position **R** for vehicles equipped with manual transmission or position **N** (except Allison 2200 transmission) or **P** (Allison 2200 transmission) for vehicles with automatic transmission. Use of wheel chocks is also recommended in hilly or off-road usage.



Pull the yellow parking brake knob out to apply the parking brake. Push the knob in to release the parking brake.



The parking brake light illuminates and remains illuminated (when the ignition is turned to the on position) until the parking brake is released.

Releasing Spring Brake with Air Pressure

The air system in all vehicles with spring-actuated rear wheel parking brakes is equipped with a tank valve located on the supply or service air tank for connection to an outside air supply. The valve permits the system to be recharged with air from an outside source, releasing the spring-actuated parking brakes. The vehicle may then be towed in an emergency.

An outside air source can be used only if the protected system is in operating condition. If air pressure cannot be restored in the protected air system, the spring-actuated brakes must be released manually.

Releasing Spring Manually



WARNING: Do not attempt to disassemble the parking brake chamber under any circumstances. The high spring load may cause serious injury if the chamber clamps are removed.

If air pressure is released from the spring brake chamber the power spring applies the brake and, unless air pressure can be re-established, the spring brake must be released as follows in order to move the vehicle.



WARNING: Block the wheels to help prevent the vehicle from moving.



WARNING: Unexpected and possibly sudden vehicle movement may occur if these precautions are not taken.

Impact wrenches should not be used as they may damage the piston and prevent proper caging of the spring. Do not apply more than 50 foot-pounds (68 newton-meters) torque to the release bolt nut.

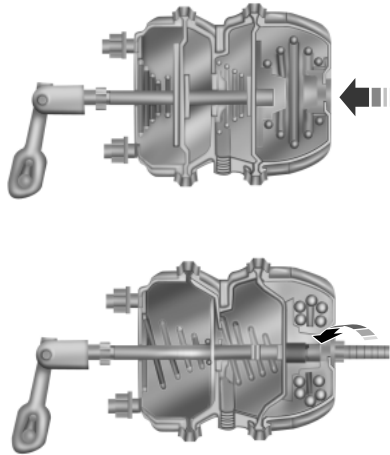

1. Remove the stud tool and nut from the carrying pocket on the brake chamber assembly.

2. Remove the access plug from the end of the spring chamber.

3. Insert the release stud through the opening in the chamber and into the spring pressure plate.

4. Turn the release stud $\frac{1}{4}$ -turn to engage the stud tangs with the slot in the pressure plate. Keep the stud engaged and install the nut on the release stud.

5. Tighten the nut until the spring is fully caged and the brakes are released. Do not loosen or remove

the release stud and nut unless the brake chamber is completely assembled and is securely clamped.

6. When the air pressure is restored, unscrew and remove the release stud and install in the carrying pocket. Install the access plug.

PRINCIPLES OF OPERATION

The traction control system helps avoid drive wheel spin and loss of traction.

If your vehicle begins to slide, the system applies the rear brakes to individual wheels and, when needed, reduces engine power at the same time. If the wheels spin when accelerating on slippery or loose surfaces, the system reduces engine power in order to increase traction.

Note: The system does not apply the brakes when vehicle speed is above 25 mph (40 km/h).

USING TRACTION CONTROL

WARNING: Aggressive driving in any road conditions can cause you to lose control of your vehicle increasing the risk of severe personal injury or property damage. The occurrence of a traction control event is an indication that at least some of the tires have exceeded their ability to grip the road; this may lead to an increased risk of loss of vehicle control, vehicle rollover, personal injury and death. If you experience a severe road event, SLOW DOWN.



Press the switch to select Off Road or Mud/Snow traction mode. This is beneficial when the vehicle is stuck in snow or on a slippery road surface. This mode allows excess wheel spin to dig the vehicle out and allows you to rock the vehicle.

Press the switch again to select standard traction control. Standard traction control is automatically selected at the next ignition cycle.

System Indicator Light

Note: If the traction control light does not flash during a traction control event or stays illuminated, the system is not functioning properly. Take your vehicle to your dealer for service.



During traction control operation, the traction control light flashes rapidly and the engine does not rev-up when you press further on the accelerator. This is normal and is no reason for concern.

In Off Road or Mud/Snow mode, the traction control light illuminates and flashes slowly. If a traction event occurs, in either mode, the light flashes rapidly.

PRINCIPLES OF OPERATION

Cruise control lets you maintain a set speed without keeping your foot on the accelerator pedal.

USING CRUISE CONTROL

WARNING: Do not use cruise control in heavy traffic or on roads that are winding, slippery or unpaved.

Note: Vehicle speed may vary momentarily when driving up or down a steep hill. Apply the brakes if your vehicle speed increases above the set speed while driving downhill.

Note: Cruise control will disengage if your vehicle speed decreases more than 10 mph (16 km/h) below your set speed while driving uphill.

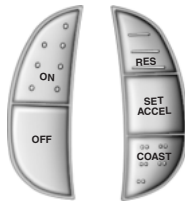

The cruise controls are located on the steering wheel.

Switching On Cruise Control

Press and release **ON**.



The indicator will turn on in the instrument cluster.

Setting a Speed

1. Accelerate to the desired speed.
2. Press and release **SET ACCEL**.
3. Take your foot off the accelerator pedal.

Changing the Set Speed

- Press and hold **SET ACCEL** to increase or **COAST** to decrease the set speed. Release the button when you reach the desired speed.
- Press and release **SET ACCEL** to increase or **COAST** to decrease. The set speed will change in approximately 1 mph (2 km/h) increments.
- Press the accelerator pedal or brake pedal until you reach the desired speed. Press and release **SET ACCEL**.

Canceling a Set Speed

Tap the brake pedal. The set speed will not be erased.

Resuming a Set Speed

Press and release **RES**.

Switching Off Cruise Control

Note: The set speed is erased when you turn off cruise control.

Press **OFF** or turn off the ignition.

OPERATING YOUR VEHICLE**General Information**

- Start the vehicle in motion by using the highest gear speed in the transmission that lets the engine easily start the load without slipping the clutch.
- Accelerate smoothly and evenly. Rapid acceleration increases fuel consumption without increasing engine performance.
- When approaching a hill, press the accelerator smoothly to start the incline at full power, then shift down as needed to maintain vehicle speed.
- When going down a hill, or long steep grades, prevent overspeeding of the engine. Normally, choose the same gear to descend the hill that you use to ascend the hill. The engine governor has no control over engine speed when it is being pushed by a loaded vehicle.
- Operate in a gear that permits an engine speed not in excess of the maximum governed speed or high-idle RPM (no load).
- Always shift to a lower gear at high altitudes to prevent engine smoking.

Backing Up

WARNING: All vehicles have blind spots. To reduce the risk of severe injury or property damage, never move your vehicle to the side or rear or change lanes without being sure your way is clear on both sides and to your rear.



WARNING: To reduce the risk of the possibility of personal injury while backing up the vehicle, always be sure your vehicle's path is clear.

Before backing up your vehicle, be sure you can do so safely. If anything behind the cab limits your view, do not rely on mirrors alone to ensure that your intended path is clear. If other people are in the vicinity, have someone standing well behind your vehicle and outside of your intended path (visible through an exterior mirror) guide you as you back up.

Although OSHA or some governmental regulations may require the use of an electrical or mechanical back up alarm to warn bystanders, such an alarm does not guarantee that the intended path is clear. When in doubt, get out of the vehicle and visually check the intended path is clear. Back up slowly as to allow others time to move, if necessary.

If an electrical back up alarm is installed, it should be connected to the back up lamp circuit.

Parking



WARNING: When parking your vehicle, do not leave the transmission in gear; if the key is in the on position and the vehicle rolls, the engine could start. Failure to follow these instructions could result in an unattended vehicle moving, possibly causing personal injury or property damage.

Always use the parking brake. When parking on a grade, block the wheels and turn the front wheels to one side so that if the vehicle rolls, the front tires act against the curb to stop the vehicle. The front wheels are more effective at stopping a rolling vehicle than the rear wheels.

Cold Weather

Note: Idling in cold weather does not heat the engine to its normal operating temperature. Long periods of idling in cold weather can cause a build-up of heavy deposits of carbon and rust on valve stems causing them to stick which, in turn, can cause valvetrain damage.

Note: The use of winter fronts, or other air-restrictive devices mounted in front of the radiator on vehicles with chassis-mounted charge air coolers, are not recommended unless extremely cold weather conditions exist. Airflow restriction can cause high exhaust temperatures, power loss, excessive fan usage and a reduction in fuel economy. If you must use a winter front, the device should have a permanent opening of at least 120 square inches (774 square centimeters) directly in line with the fan hub.

For best engine operation in temperatures of 32°F (0°C) or lower:

- Make sure the batteries are the correct type and are fully charged. Check other electrical components to make sure they are in optimum condition.
- Use a permanent-type engine coolant to protect the engine against damage from freezing.
- If your vehicle is equipped with a water-fuel separator, drain it daily. Fill the fuel tank at the end of daily operation to prevent condensation in the fuel system.
- Use the proper engine oil and maintain it at its proper level.
- At temperatures of -4°F (-20°C) or below, it is recommended that you use a crankcase-mounted coolant heater to improve cold engine starting.
- If operating in arctic temperatures of -20°F (-29°C) or lower, consult your truck dealer for information about special cold weather equipment and precautions.

Hot Weather

- Use a permanent-type engine coolant to protect the engine against damage from overheating.
- Fill the fuel tank at the end of daily operation to prevent condensation in the fuel system.
- Keep external surfaces of the engine, radiator, charge air cooler, A/C condenser and accessories clean to avoid dirt build-up.
- Above normal coolant temperatures could be experienced while driving in a transmission gear ratio which lugs the engine. To correct this problem, engine speed should be increased by downshifting into the next lower gear.

STEERING

Your vehicle is equipped with power steering. Power steering uses energy from the engine to decrease the driver's effort in steering the vehicle.

To help prevent damage to the power steering pump:

- Never hold the steering wheel to the extreme right or the extreme left for more than a few seconds when the engine is running.
- Do not operate the vehicle with the power steering pump fluid level below the ADD mark on the MAX. COLD side of the power steering reservoir dipstick.
- Some noise is normal during operation. If the noise is excessive, check for low power steering pump fluid level before seeking service by your authorized dealer.
- Heavy or uneven steering efforts may be caused by low power steering pump fluid level. Check for low power steering pump fluid level before seeking service by your authorized dealer.
- Do not fill the power steering pump reservoir above the FULL mark on the MAX. HOT side of the power steering reservoir dipstick, as this may result in leaks from the reservoir.

If the power steering system breaks down (or if the engine is turned off), you can steer the vehicle manually, but it takes more effort.

If the steering wanders or pulls, check for:

- underinflated tire(s) on any wheel(s)
- uneven vehicle loading
- high crown in center of road
- high crosswinds
- wheels out of alignment
- loose or worn suspension components.

AIR SUSPENSION (IF EQUIPPED)

Note: The vehicle must not be operated without air in the suspension springs. Operating the vehicle without air in the suspension springs damages the suspension, degrades ride performance and may cause property damage.

The air suspension system automatically adjusts to different loads to maintain a constant frame height, allows for ease of vehicle loading and provides improved vehicle ride and increased driver comfort.

Air Suspension Dump Switch

Note: The suspension dumps air when the ignition is in the accessory or on position, but fills only when the ignition is in the on position.

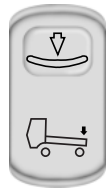

The system is controlled by a switch located in the overhead switch pack. It operates only when the ignition is in the accessory or on position and the air tanks have sufficient pressure to fill the air springs. When the ignition is turned off, the suspension remains in whatever state it was last set.

Pressing the lower portion of the switch exhausts air from the air springs, lowering the frame for loading. Pressing the upper portion of the switch fills the air springs so the vehicle remains at normal ride height.

System Indicator Light

**CK
SUSP**

The air suspension indicator light illuminates when the switch has been activated to release air pressure in the rear air shocks. Never drive the vehicle when the warning lamp is illuminated and there is low (or no) air pressure in the shocks.

Connecting and Disconnecting a Trailer with Air Suspension and Air Suspension Dump Switch

When connecting to a trailer:

- Press the lower portion of the switch to exhaust air from the air suspension system.
- Press the upper portion of the switch, then raise the landing gear after making the connection to the trailer.

When disconnecting the trailer:

- Lower the landing gear, then press the lower portion of the switch.
- Disconnect the brake hoses, trailer-side and rear light connectors, then pull the release lever on the fifth-wheel.

The upper portion of the switch must be pressed before operating with a trailer or operating in the bobtail mode.

Suspension Conversions



WARNING: When operating a loaded vehicle, the driver must keep all adjustable axles on the ground at all times, supporting their share of the vehicle's load. Failure to do so can overload other axles, tires, wheels, springs, steering components, brakes and frames, resulting in early component failure, loss of vehicle control, possible property damage and personal injury.

It is not recommended, or approved, that suspension conversions be performed. However, it is understood that, on occasion, aftermarket add-on suspensions are installed by others on the truck chassis which allow operator control for weight transfer from other axles (i.e., air lift axles).

UPFITTER CONTROLS (IF EQUIPPED)



The upfitter option package provides four switches, mounted in the center of the instrument panel. These switches are always on whether the engine is running or not. Make sure you put the switches in the off position to avoid draining the battery when the vehicle is not

being used. It is recommended that the engine remain running to maintain battery charge when using the upfitter switches for extended duration or higher current draws. (This is even more important for vehicles with a diesel engine since the glow plugs are also draining battery power when the ignition key is in the on position.)

Each switch provides 10 amps of electrical battery power for a variety of personal or commercial uses.

There is also a relay box located on the passenger side end of the instrument panel. See your authorized dealer for service.

Switch access location is in a connector located in the engine compartment. More detailed information can be found at <https://www.fleet.ford.com/truck/bbas/>.

LOAD LIMIT



WARNING: Do not exceed the GVWR or the GAWR specified on the Safety Compliance Certification Label.



WARNING: Do not use replacement tires with lower load carrying capacities than the originals because they may lower the vehicle's GVWR and GAWR limitations. Replacement tires with a higher limit than the originals do not increase the GVWR and GAWR limitations.



WARNING: Exceeding any vehicle weight rating limitation could result in serious damage to the vehicle and/or personal injury.

Every vehicle manufactured by Ford Motor Company is supplied with information on the Safety Compliance Certification Label, located on either the B-pillar or the driver's door edge, listing the maximum loading for the vehicle (GVWR), and its axle systems (GAWR) at the tire to ground interface.

A product of FORD MOTOR COMPANY							
Incomplete Vehicle Manufactured By (Vehicle incomplet fabrique par)							
BLUE DIAMOND TRUCK, S. de R.L. de C.V.							
G P		G P	FRONT	G P	REAR		
V N	(33000 LB)	A N	(12000 LB)	A N	(21000 LB)		
W B	14969 KG	W B	5443 KG	W B	9525 KG		
R V		R E		R E			
A SUITABLE TIRE		11RX22.5-14 TIRES		11RX22.5-14 TIRES			
AND RIM CHOICE:		22.5X8.25 RIMS		22.5X8.25 RIMS			
WB: 194.0 IN 493.0 CM		AT 724 KPA/105 PSI COLD		AT 724 KPA/105 PSI COLD DUAL		ASSEMBLED IN MEXICO	
		Model: F750 4X2					
VIN 3FRXF75L0V285893				MFD ON AUG-24-2006			
VIN BARCODE HERE							
Ext. Pnt: XX		Int. Trim: XX		Axle: XX		Tran: X	

Under no circumstances should your vehicle be loaded in excess of the GVWR or GAWR. It is the operator's responsibility to ensure that neither the axle capacities, spring capacities, tire capacities nor the vehicle rated GVWR is exceeded.

Unloaded or Lightly Loaded Vehicles

WARNING: When operating empty or lightly loaded, sudden or hard braking may induce wheel lockup with loss of vehicle control and the possibility of accident and serious injury, especially on wet or slippery road surfaces.

The braking system has been designed to safely stop your vehicle when fully loaded to its GVWR.

TOWING A TRAILER

WARNING: Do not exceed the GVWR or the GAWR specified on the certification label.



WARNING: Towing trailers beyond the maximum recommended gross trailer weight exceeds the limit of the vehicle and could result in engine damage, transmission damage, structural damage, loss of vehicle control, vehicle rollover and personal injury.

Your vehicle's load capacity is designated by weight, not by volume, so you cannot necessarily use all available space when loading a vehicle. Second-unit bodies are not included in maximum trailer weight ratings. The weight of the additional body must be subtracted from the maximum trailer weight.

Towing a trailer places an additional load on your vehicle's engine, transmission, axle, brakes, tires and suspension. Inspect these components periodically during, and after, any towing operation.

Load Placement

To help minimize how trailer movement affects the vehicle when driving:

- Load the heaviest items closest to the trailer floor.
- Load the heaviest items so they are centered between the left and right side trailer tires.
- Load the heaviest items above the trailer axles or just slightly forward toward the trailer tongue. Do not allow the final trailer tongue weight to go above or below 10–15% of the loaded trailer weight.

RECOMMENDED TOWING WEIGHTS

Model	Maximum GVWR - lb (kg)	Maximum GCWR
F-650 Pro-Loader (Kick-Up Frame)	20500–26000 (9299–11792)	*
F-650 Pro-Loader (Straight Frame)/F-650 Straight Frame	20500–29000 (9299–13154)	*
F-750	25999–37000 (11793–16783)	*

*Specific GCWR and maximum trailer weight applicable to a given F-650/750 model is dependent on many variables including transmission capability. Check with your sales consultant for the exact rating on your vehicle.

ESSENTIAL TOWING CHECKS

Service your vehicle more frequently if you tow a trailer. See your scheduled maintenance information.

For load specification terms found on the Tire Label and Safety Compliance Certification Label and for instructions on calculating your vehicle's load, see *Load limit* in the *Load Carrying* chapter.

Hitches

Do not use a hitch that either clamps onto the bumper or attaches to the axle.

Distribute the trailer load so 10-15% of the total trailer weight is on the tongue.

Safety Chains

Note: Do not attach safety chains to the bumper.

Always connect the trailer's safety chains to the frame or hook retainers of your vehicle hitch.

To connect the trailer's safety chains, cross the chains under the trailer tongue and allow enough slack for turning tight corners. Do not allow the chains to drag on the ground.

Trailer Brakes



WARNING: Do not connect a trailer's hydraulic brake system directly to your vehicle's brake system. Your vehicle may not have enough braking power and your chances of having a crash greatly increase.

Electric brakes and manual, automatic or surge-type trailer brakes are safe if installed properly and adjusted to the manufacturer's specifications. The trailer brakes must meet local and federal regulations.

The braking system of the tow vehicle is rated for operation at the GVWR not GCWR.

Trailer Lamps



WARNING: Never connect any trailer lamp wiring to the vehicle's tail lamp wiring; this may damage the electrical system resulting in a fire. Contact an authorized dealer as soon as possible for assistance in proper trailer tow wiring installation. Additional electrical equipment may be required.

Trailer lamps are required on most towed vehicles. Make sure all running lights, brake lights, turn signals and hazard lights are working.

Before Towing a Trailer

Practice turning, stopping and backing up to get the feel of your vehicle-trailer combination before starting on a trip. When turning, make wider turns so the trailer wheels clear curbs and other obstacles.

When Towing a Trailer

- Check your hitch, electrical connections and trailer wheel lug nuts thoroughly after you have traveled 50 miles (80 kilometers).
- Place the gearshift lever in position **P** (if equipped) or neutral to aid in engine and transmission cooling and A/C efficiency during hot weather while stopped in traffic.
- Turn off the speed control. The speed control may turn off automatically when you are towing on long, steep grades.
- Shift to a lower gear when driving down a long or steep hill. Do not apply the brakes continuously, as they may overheat and become less effective.
- Allow more distance for stopping with a trailer attached. Anticipate stops and brake gradually.

FIFTH-WHEEL OPERATION



WARNING: Failure to follow the fifth-wheel manufacturer's instructions for hooking and unhooking as well as sliding the fifth-wheel could result in an accident, personal injury or death.



WARNING: When the tractor and trailer are parked unattended, the trailer brake hand control should never be used to apply the brake, since air may leak from the system, allowing vehicle movement, resulting in possible property damage, personal injury or death.

Before hook-up, make sure:

- The fifth-wheel jaws are fully opened.
- The fifth-wheel is fully tilted back to prevent body damage when the tractor is backed under a trailer.
- The trailer wheels are blocked and the trailer spring brakes are adjusted and applied. Never chase a trailer.
- The brake hoses and light cords are clear of the fifth-wheel.

Hook-up

1. Back the tractor squarely under the trailer, engaging the fifth-wheel jaws on the kingpin. Always back up slowly, making sure the trailer is neither too high nor too low. Avoid backing under the trailer from an angle.
2. Connect the service and emergency brake hoses and trailer light connector.
3. Inspect the jaws of the fifth-wheel to be sure they have fully closed on the trailer kingpin and the trailer plate is resting securely on the fifth-wheel.
4. Make sure the coupler release lever is in the locked position.
5. Charge the trailer brake system. Set the trailer brakes, either with the hand valve or tractor protection valve. Pull against the trailer for an additional check of proper hook-up. Do not pull hard enough to damage or strain the equipment.
6. Set the tractor parking brakes and fully raise the trailer landing gear. See the *Brakes* chapter for proper operation of the parking brake and trailer brakes.
7. Check the operation of all trailer lights and correct any lights that may be faulty.

Un-hook

1. Try to keep the tractor and trailer in a straight line.
2. Apply the parking brakes.
3. Lower the trailer landing gear, making sure it is on solid, level ground. The weight of the trailer is to be on the landing gear.
4. Block the trailer wheels.
5. Disconnect the brake hoses and light cords. Be sure hoses and cords are clear.
6. Pull coupler release lever to disengage the fifth-wheel jaws.
7. Release the tractor parking brakes.
8. Pull out from the trailer slowly, allowing the landing gear to take the load gradually.

WRECKER TOWING

WARNING: To reduce the risk of personal injury or property damage when manually releasing the spring brakes, be sure to block the wheels so the vehicle cannot move once the brakes are released.

Note: Make sure the vehicle is securely connected to the tow vehicle and that the tow vehicle's parking brakes are applied before releasing the disabled vehicle's spring brakes.

Before moving the disabled vehicle, check for adequate road clearance of vehicle components. It is recommended the disabled vehicle be unloaded prior to being towed to reduce any abnormal load to the vehicle components resulting from the towing procedures. Before towing, make sure the parking brake is fully released. The spring-actuated type parking brake can be reset by recharging the air system with at least 64 psi (441 kPa) of air. If the brake system does not retain air pressure, then the spring brakes must be released manually. See *Parking brake* in the *Brakes* chapter.

Towing the Vehicle with the Front Wheels Suspended

Note: To avoid transmission damage, vehicles should not be towed even a short distance without suspending rear wheels or removing the axle shafts or driveshaft.

Note: In the event the chassis is equipped with a tandem axle and the vehicle is to be towed from the front, the forward rear axle may be raised to clear the road surface and secured to the frame by chains or U-bolts, allowing only the rear rear axle to contact the road surface. Axle shafts must be removed from the rear rear axle assembly. The wheel hub ends must be covered to prevent loss of axle lubricant and entrance of contaminants. Use extreme care in securing the chains or U-bolts to avoid possible damage to the brake lines, hoses or other components.

When it is necessary to tow a vehicle with the front wheels suspended, extra precautions must be taken to avoid transmission or differential damage:

- Remove the axle shafts from the axle assembly to prevent the wheels from driving the differential and the transmission.
- The wheel hub ends must be covered to prevent loss of axle lubricant and entrance of other contaminants. If the axle shafts are not removed, removal of the driveshaft is required.

Towing the Vehicle with the Rear Wheels Suspended

Note: To avoid damage to the cab roof or air deflector when towing the vehicle backward (rear wheels suspended), the air deflector must be removed.

Whenever possible, it is preferable to tow a disabled vehicle from the rear by raising the rear of the chassis. When towing a vehicle with the rear of the chassis suspended, the front wheels must be locked in the straight-ahead position.

Vehicles equipped with a manual transmission must have at least 1.0 pint (0.5 liter) of transmission fluid drained from the case. This prevents the transmission fluid from entering the clutch housing and saturating the clutch discs. Make sure that the transmission fluid is replaced before the vehicle is returned to service.

Towing Vehicles Equipped with a Driver-controlled Differential Lock

Note: If the vehicle must be towed to a service facility with the drive axle wheels on the ground, it is necessary to remove the axle shafts before the vehicle is towed.

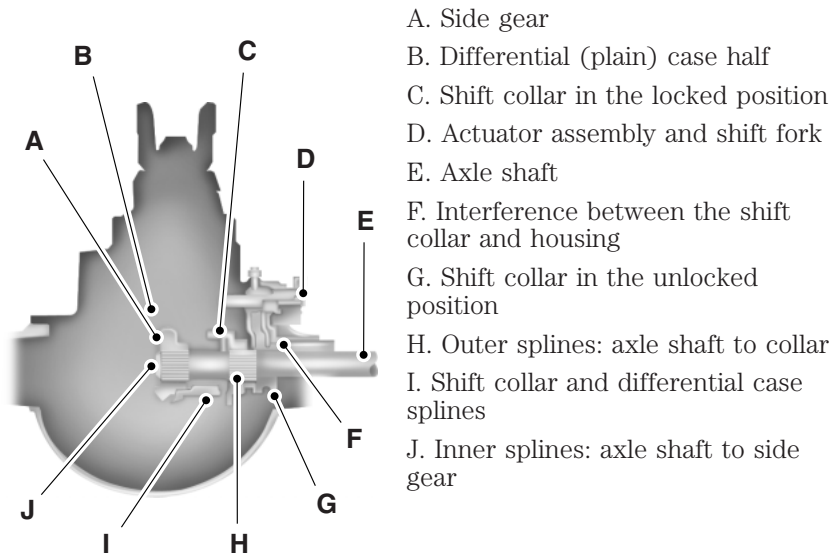

- A. Side gear
- B. Differential (plain) case half
- C. Shift collar in the locked position
- D. Actuator assembly and shift fork
- E. Axle shaft
- F. Interference between the shift collar and housing
- G. Shift collar in the unlocked position
- H. Outer splines: axle shaft to collar
- I. Shift collar and differential case splines
- J. Inner splines: axle shaft to side gear

Removing Axle Shafts before Towing

1. Shift the main differential to the unlocked (disengaged) position; the differential lock light turns off.
2. Remove the capscrews and washers or stud nuts and washers from flanges of both axle shafts.
3. Loosen the tapered dowels in the flanges of both axle shafts by holding a 1½ inch diameter brass drift or hammer against the axle shaft center and hitting it with a five or six pound hammer. **Note:** Do not use a chisel or wedge to loosen the axle shafts and dowels. Use of a chisel or wedge can damage the hub, axle shafts and oil seals.
4. Remove the tapered dowels and both axle shafts from the axle assembly.
5. Assemble a cover over openings of both wheel ends to prevent loss of lubricant and keep dirt away from the wheel bearing cavities.

Note: One of the axle shafts has two sets of splines. One set to engage with the differential side gear and one set to engage with the shift collar for the differential lock. It may be necessary to rotate the shaft slightly to align the gear spline teeth with the shift collar teeth in order to remove the axle shaft.

Installing the Axle Shafts

1. Remove the covers from the wheel ends.
2. Shift the differential lock to the unlocked (disengaged) position.
3. Install the axle shafts.
 - Place the gaskets on the wheel hub studs.
 - Push the right-hand axle shaft and gasket into the wheel end and housing until the shaft stops against the differential shift collar.
 - Push down and in on the axle shaft flange and rotate the shaft until the splines of the shaft and shift collar are engaged.
 - Push the axle shaft further into the housing until the shaft stops against the differential side gear.
 - Push down on the axle shaft flange and rotate the shaft until the splines of the shaft and side gear are engaged.
 - Push the axle shaft completely into the housing until the axle shaft flange and the gasket are flush against the wheel hub.
 - Install the left-hand axle shaft and gasket into the wheel end.
4. If tapered dowels are required, install them at each stud and into the flange of the axle shaft. Use a punch or drift and hammer, if needed.
5. Install the fasteners and tighten to correct torque value. See the *Workshop Manual*.

BREAKING-IN

You need to break in new tires for approximately 300 miles (480 kilometers). During this time, your vehicle may exhibit some unique driving characteristics. Avoid driving too fast during the first 1000 miles (1600 kilometers). Vary your speed frequently and change up through the gears early. Do not labor the engine.

ECONOMICAL DRIVING

Fuel economy is affected by several things such as how you drive, the conditions you drive under and how you maintain your vehicle.

There are some things to keep in mind that may improve your fuel economy:

- Accelerate and slow down in a smooth, moderate fashion.
- Drive at steady speeds without stopping.
- Anticipate stops; slowing down may eliminate the need to stop.
- Close the windows for high-speed driving.
- Drive at reasonable speeds (traveling at 55 mph [88 km/h] uses 15% less fuel than traveling at 65 mph [105 km/h]).
- Keep the tires properly inflated and use only the recommended size.
- Use the recommended engine oil.
- Perform all regularly scheduled maintenance.

There are also some things you may not want to do because they may reduce your fuel economy:

- Sudden or hard accelerations.
- Warm up your vehicle on cold mornings.
- Use the air conditioner or front defroster.
- Use the speed control in hilly terrain.
- Rest your foot on the brake pedal while driving.
- Carry unnecessary weight (approximately 1 mpg [0.4 km/L] is lost for every 400 pounds [180 kilograms] of weight carried).
- Add particular accessories to your vehicle (e.g., bug deflectors, rollbars and light bars, running boards, ski racks).
- Drive with the wheels out of alignment.

DRIVING THROUGH WATER

If driving through deep or standing water is unavoidable, proceed very slowly especially if the depth is not known. Never drive through water that is higher than the bottom of the hubs. Traction or brake capability may be limited and your vehicle may stall. Water may also enter your engine's air intake and severely damage your engine, drive axles or the transmission (through the breather ports).

Once through the water, always dry the brakes by moving your vehicle slowly while applying light pressure on the brake pedal. Wet brakes do not stop the vehicle as quickly as dry brakes.

ROADSIDE ASSISTANCE**Vehicles Sold in the U.S.: Getting Roadside Assistance**

To fully assist you should you have a vehicle concern, Ford Motor Company offers a complimentary roadside assistance program. This program is separate from the New Vehicle Limited Warranty and is not applicable to vehicles sold in Canada. The services are available:

- 24-hours, seven days a week
- for the New Vehicle Limited Warranty period (U.S.) of two years (unlimited miles).

Roadside assistance covers:

- battery jump start
- lock-out assistance (Key replacement cost is the customer's responsibility.)
- towing – Ford eligible vehicles towed to an authorized dealer within 35 miles (56 kilometers) of the disablement location or to the nearest authorized dealer. If a member requests to be towed to an authorized dealer more than 35 miles (56 kilometers) from the disablement location, the member shall be responsible for any mileage costs in excess of 35 miles (56 kilometers).

Trailers shall be covered up to \$200 if the disabled eligible vehicle requires service at the nearest authorized dealer. If the trailer is disabled, but the towing vehicle is operational, the trailer does not qualify for any roadside services.

Vehicles Sold in the U.S.: Using Roadside Assistance

Complete the roadside assistance identification card and place it in your wallet for quick reference. This card is found in the owner's information portfolio in the glove compartment.

U.S. Ford vehicle customers who require Roadside Assistance, call 1-800-241-3673.

If you need to arrange roadside assistance for yourself, Ford Motor Company reimburses a reasonable amount for towing to the nearest dealership within 35 miles (56 kilometers). To obtain reimbursement information, U.S. Ford vehicle customers call 1-800-241-3673. Customers are asked to submit their original receipts.

Vehicles Sold in Canada: Getting Roadside Assistance

Canadian customers who require roadside assistance, call:
1-800-665-2006.

Vehicles Sold Canada: Using Roadside Assistance

Complete the roadside assistance identification card and place it in your wallet for quick reference. In Canada, the card is found in the warranty information in the glove box.

Canadian Roadside coverage and benefits may differ from the U.S. coverage. Please see your warranty information or visit our website at www.ford.ca for information on Canadian services and benefits.

Canadian customers who need to obtain roadside information, call 1-800-665-2006 or visit our website at www.ford.ca.

HAZARD FLASHER CONTROL

Note: With extended use, the flasher may run down your battery.

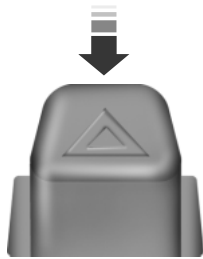

The hazard flasher is located on the steering column, just behind the steering wheel. The hazard flashers will operate when the ignition is in any position or if the key is not in the ignition.

- Press the flasher control and all front and rear direction signals flash.
- Press the flasher control again to turn them off.

Use it when your vehicle is disabled and is creating a safety hazard for other motorists.

JUMP-STARTING THE VEHICLE

WARNING: The gases around the battery can explode if exposed to flames, sparks, or lit cigarettes. An explosion could result in injury or vehicle damage.



WARNING: Batteries contain sulfuric acid which can burn skin, eyes and clothing, if contacted.

Do not attempt to push-start your automatic transmission vehicle. Automatic transmissions do not have push-start capability. Attempting to push-start a vehicle with an automatic transmission may cause transmission damage.

Six-speed TorqShift® transmissions have an adaptive shift strategy. When the battery is disconnected or a new battery is installed, the automatic transmission must relearn its shift strategy. As a result, the transmission may have firm soft shifts, firm shifts or both. This operation is considered normal and does not affect function or durability of the transmission. Over time, the adaptive learning process fully updates transmission operation.

Preparing Your Vehicle

Note: Use only a 12-volt supply to start your vehicle.

Note: Do not disconnect the battery of the disabled vehicle as this could damage the vehicle's electrical system.

1. Park the booster vehicle close to the hood of the disabled vehicle making sure the two vehicles do not touch. Set the parking brake on both vehicles and stay clear of the engine cooling fan and other moving parts.
2. Check all battery terminals and remove any excessive corrosion before you attach the battery cables. Make sure that vent caps are tight and level.
3. Turn the heater fan on in both vehicles to protect from any electrical surges. Turn all other accessories off.

Connecting the Jumper Cables



WARNING: Do not connect the end of the second cable to the negative (-) terminal of the battery to be jumped. A spark may cause an explosion of the gases that surround the battery.

Note: Do not attach the negative (-) cable to fuel lines, engine rocker covers, the intake manifold or electrical components as grounding points.

Note: In the illustration, the vehicle on the bottom is used to designate the assisting (boosting) battery.

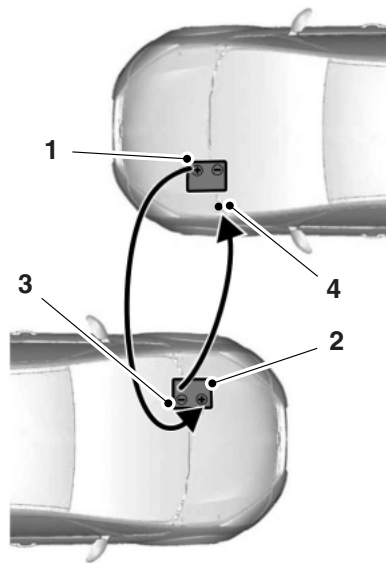

1. Connect the positive (+) jumper cable to the positive (+) terminal of the discharged battery.
2. Connect the other end of the positive (+) cable to the positive (+) terminal of the assisting battery.
3. Connect the negative (-) cable to the negative (-) terminal of the assisting battery.
4. Make the final connection of the negative (-) cable to an exposed metal part of the stalled vehicle's engine, away from the battery and the carburetor or fuel injection system.

Make sure that the cables are clear of fan blades, belts, moving parts of both engines, or any fuel delivery system parts.

Jump Starting

1. Start the engine of the booster vehicle and run the engine at moderately increased speed.
2. Start the engine of the disabled vehicle.
3. Once the disabled vehicle has been started, run both engines for an additional three minutes before disconnecting the jumper cables.

Removing the Jumper Cables

Note: In the illustration, the vehicle on the bottom is used to designate the assisting (boosting) battery.

Remove the jumper cables in the reverse order that they were connected.

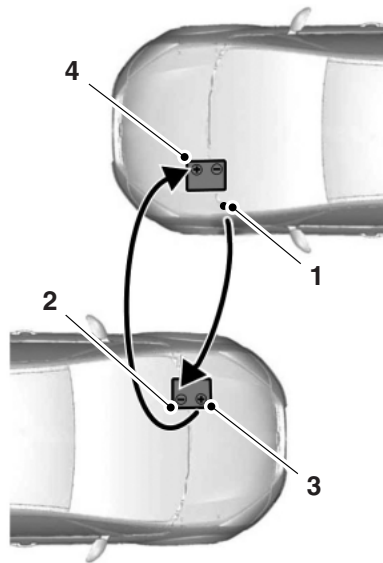

1. Remove the jumper cable from the ground metal surface.
2. Remove the jumper cable on the negative (-) terminal of the booster vehicle's battery.
3. Remove the jumper cable from the positive (+) terminal of the booster vehicle's battery.
4. Remove the jumper cable from the positive (+) terminal of the disabled vehicle's battery.

After the disabled vehicle has been started and the jumper cables removed, allow it to idle for several minutes so the engine computer can relearn its idle conditions.

GETTING THE SERVICES YOU NEED

Warranty repairs to your vehicle must be performed by an authorized Ford dealer. While any authorized dealer handling your vehicle line will provide warranty service, we recommend that you return to your authorized selling dealer to ensure your continued satisfaction.

Please note that certain warranty repairs require special training or equipment, so not all authorized dealers are authorized to perform all warranty repairs. This means that, depending on the warranty repair needed, you may need to take your vehicle to another authorized dealer.

If you have questions or concerns, or are unsatisfied with the service you are receiving, follow these steps:

1. Contact your Sales Representative or Service Advisor at your selling or servicing dealership.
2. If your inquiry or concern remains unresolved, contact the Sales Manager or Service Manager at the dealership.
3. If the inquiry or concern cannot be resolved at the dealership level, contact the Ford Commercial Vehicle Operations Hotline. Please have the following information available:
 - Vehicle Identification Number (VIN)
 - your telephone number (home and business)
 - the name of the authorized dealer and city where located
 - the vehicle's current odometer reading.

In some states, you must directly notify Ford in writing before pursuing remedies under your state's warranty laws. Ford is also allowed a final repair attempt in some states.

In the United States:

Mailing address

Ford Motor Company
Commercial Vehicle Operations
PO Box 6248
Dearborn, MI 48121

Telephone

800-782-8627 (option #3)
(TDD for the hearing impaired: 1-800-232-5952)

Online

Additional information and resources are available online at www.fleet.ford.com:

- U.S. dealer locator by Dealer Name, City/State, or Zip Code
- Owner Guides
- Maintenance Schedules

- Recalls
- Ford Extended Service Plans
- Ford Genuine Accessories.

In Canada:

Mailing address

Customer Relationship Centre
Ford Motor Company of Canada, Limited
P.O. Box 2000
Oakville, Ontario L6J 5E4

Telephone

800-565-3673 (FORD)

Online

www.ford.ca

IN CALIFORNIA (U.S. ONLY)

California Civil Code Section 1793.2(d) requires that, if a manufacturer or its representative is unable to repair a motor vehicle to conform to the vehicle's applicable express warranty after a reasonable number of attempts, the manufacturer shall be required to either replace the vehicle with one substantially identical or repurchase the vehicle and reimburse the buyer in an amount equal to the actual price paid or payable by the consumer (less a reasonable allowance for consumer use). The consumer has the right to choose whether to receive a refund or replacement vehicle.

California Civil Code Section 1793.22(b) presumes that the manufacturer has had a reasonable number of attempts to conform the vehicle to its applicable express warranties if, within the first 18 months of ownership of a new vehicle or the first 18000 miles (29000 kilometers), whichever occurs first:

1. Two or more repair attempts are made on the same nonconformity likely to cause death or serious bodily injury OR
2. Four or more repair attempts are made on the same nonconformity (a defect or condition that substantially impairs the use, value or safety of the vehicle) OR
3. The vehicle is out of service for repair of nonconformities for a total of more than 30 calendar days (not necessarily all at one time).

In the case of 1 or 2 above, the consumer must also notify the manufacturer of the need for the repair of the nonconformity at the following address:

Ford Motor Company
16800 Executive Plaza Drive
Mail Drop 3NE-B
Dearborn, MI 48126

**UTILIZING THE MEDIATION/ARBITRATION PROGRAM
(CANADA ONLY)**

For vehicles delivered to authorized Canadian dealers. In those cases where you continue to feel that the efforts by Ford of Canada and the authorized dealer to resolve a factory-related vehicle service concern have been unsatisfactory, Ford of Canada participates in an impartial third party mediation/arbitration program administered by the Canadian Motor Vehicle Arbitration Plan (CAMVAP).

The CAMVAP program is a straightforward and relatively speedy alternative to resolve a disagreement when all other efforts to produce a settlement have failed. This procedure is without cost to you and is designed to eliminate the need for lengthy and expensive legal proceedings.

In the CAMVAP program, impartial third-party arbitrators conduct hearings at mutually convenient times and places in an informal environment. These impartial arbitrators review the positions of the parties, make decisions and, when appropriate, render awards to resolve disputes. CAMVAP decisions are fast, fair, and final as the arbitrator's award is binding on both you and Ford of Canada.

CAMVAP services are available in all Canadian territories and provinces. For more information, without charge or obligation, call your CAMVAP Provincial Administrator directly at 1-800-207-0685 or visit www.camvap.ca.

GETTING ASSISTANCE OUTSIDE THE U.S AND CANADA

Before exporting your vehicle to a foreign country, contact the appropriate foreign embassy or consulate. These officials can inform you of local vehicle registration regulations and where to find diesel fuel.

If you cannot find diesel fuel or can only get fuel with an anti-knock index lower than is recommended for your vehicle, contact a regional office or owner relations/customer relationship office.

The use of low quality diesel fuel may affect your emissions control system and may cause engine damage. Ford Motor Company/Ford of Canada is not responsible for any damage caused by use of improper fuel. In the United States, using leaded fuel may also result in difficulty importing your vehicle back into the U.S.

Ford dealerships outside of the U.S. and Canada may be unable to support the F-650/750 due to the specialized training and servicing requirements of these vehicles. If your vehicle must be serviced while you are traveling or living in Central or South America, the Caribbean, or the Middle East, contact the nearest Ford dealership. If the dealership cannot help you, write or call:

FORD MOTOR COMPANY
FORD EXPORT OPERATIONS
1555 Fairlane Drive
Fairlane Business Park #3
Allen Park, Michigan 48101
U.S.A.
Telephone: (313) 594-4857
FAX: (313) 390-0804

If you are in another foreign country, contact the nearest Ford dealership. If the dealership employees cannot help you, they can direct you to the nearest Ford affiliate office.

If you buy your vehicle in North America and then relocate outside of the U.S. or Canada, register your vehicle identification number (VIN) and new address with Ford Motor Company Export Operations.

ORDERING ADDITIONAL OWNER'S LITERATURE

To order the publications in this portfolio, contact Helm, Incorporated at:

HELM, INCORPORATED
47911 Halyard Drive
Plymouth, Michigan 48170
Attention: Customer Service

Or to order a free publication catalog, call toll free: 1-800-782-4356

Monday-Friday 8:00 a.m. - 6:00 p.m. EST

Helm, Incorporated can also be reached by their website:
www.helminc.com.

(Items in this catalog may be purchased by credit card, check or money order.)

Obtaining a French Owner's Manual

A French owner's manual can be obtained from your authorized dealer or by contacting Helm, Incorporated using the contact information listed previously in this section.

REPORTING SAFETY DEFECTS (U.S. ONLY)

If you believe that your vehicle has a defect which could cause a crash or could cause injury or death, you should immediately inform the National Highway Traffic Safety

Administration (NHTSA) in addition to notifying Ford Motor Company.

If NHTSA receives similar complaints, it may open an investigation, and if it finds that a safety defect exists in a group of vehicles, it may order a recall and remedy campaign. However, NHTSA cannot become involved in individual problems between you, your dealer, or Ford Motor Company.

To contact NHTSA, you may call the Vehicle Safety Hotline toll-free at 1-888-327-4236 (TTY: 1-800-424-9153); go to <http://www.safercar.gov>; or write to:

Administrator
1200 New Jersey Avenue, Southeast
Washington, D.C. 20590

You can also obtain other information about motor vehicle safety from <http://www.safercar.gov>.

REPORTING SAFETY DEFECTS (CANADA ONLY)

If you believe that your vehicle has a defect which could cause a crash or could cause injury or death, you should immediately inform Transport Canada, using their toll-free number: 1-800-333-0510, or online at: <https://www.wapps.tc.gc.ca/Saf-Sec-Sur/7/PCDB-BDPP/Index.aspx>.

CHANGING A FUSE**Fuses**

WARNING: Always replace a fuse with one that has the specified amperage rating. Using a fuse with a higher amperage rating can cause severe wire damage and could start a fire.

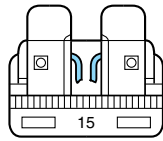

If electrical components in your vehicle are not working, a fuse may have blown. Blown fuses are identified by a broken wire within the fuse. Check the appropriate fuses before replacing any electrical components.

Standard Fuse Amperage Rating and Color

COLOR					
Fuse rating	Mini fuses	Standard fuses	Maxi fuses	Cartridge maxi fuses	Fuse link cartridge
2A	Grey	Grey	—	—	—
3A	Violet	Violet	—	—	—
4A	Pink	Pink	—	—	—
5A	Tan	Tan	—	—	—
7.5A	Brown	Brown	—	—	—
10A	Red	Red	—	—	—
15A	Blue	Blue	—	—	—
20A	Yellow	Yellow	Yellow	Blue	Blue
25A	Natural	Natural	—	Natural	Natural
30A	Green	Green	Green	Pink	Pink
40A	—	—	Orange	Green	Green
50A	—	—	Red	Red	Red
60A	—	—	Blue	Yellow	Yellow
70A	—	—	Tan	—	Brown
80A	—	—	Natural	Black	Black

FUSE SPECIFICATION CHART

Power Distribution Box



WARNING: Always disconnect the battery before servicing high current fuses.



WARNING: To reduce risk of electrical shock, always replace the cover to the power distribution box before reconnecting the battery or refilling fluid reservoirs.

The power distribution box has high-current fuses that protect your vehicle's main electrical systems from overloads.

If the battery has been disconnected and reconnected, see *Changing the vehicle battery* in the *Maintenance* chapter.

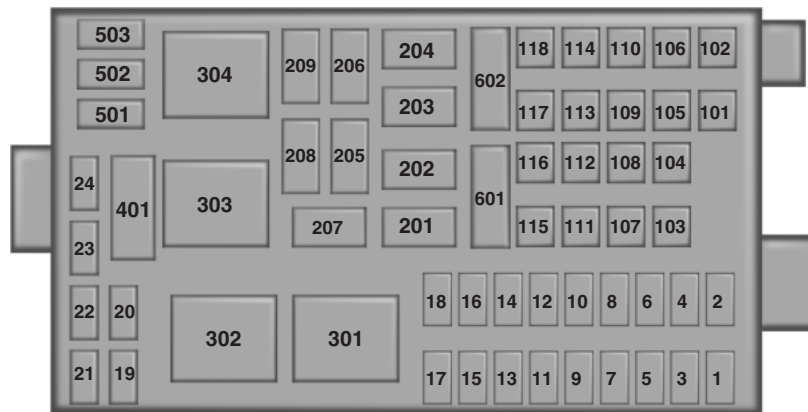

Fuse/Relay Location	Fuse Amp Rating	Protected Circuits
1	20A	Upfitter switches (AUX 2 and AUX 4)/Trailer 12V socket pin
2	30A	Power seat (driver)
3	30A	Power seat (passenger)
4	15A	Windshield washer relay, Washer pump motor
5	5A	Brake warning switch (hydraulic brake vehicles only)
6	20A	Upfitter switches (AUX 1 and AUX 3)
7	15A	Brake pressure switches, ABS event relay
8	20A	DEF (Urea) line heaters (diesel engine only)
9	20A	Ignition switch, Starter cutoff
10	15A	Air tank moisture removal valve
11	30A	Electric trailer brake
12	20A	Passenger compartment fuse box 5 and 21
13	15A	Instrument cluster/Gateway module
14	20A	Nitrogen oxide sensor (diesel engine only)
15	—	Not used
16	5A	Bendix® Air ABS
17	—	Not used
18	10A	Fuel transfer pump
19	15A	Powertrain control module power 1 (gasoline engine only)
20	10A	Powertrain control module power 2 (gasoline engine only)
21	20A	Powertrain control module power 3 (gasoline engine only)
22	20A	Powertrain control module power 4 (gasoline engine only)
23	—	Not used
24	10A	Powertrain control module keep-alive power (gasoline engine only)

Fuses

197

Fuse/Relay Location	Fuse Amp Rating	Protected Circuits
101	30A	Bendix Air ABS relay (Air brake vehicles only)
		Hydraulic brakes module (hydraulic brake vehicles only)
102	20A	Ignition switch
103	20A	Ignition switch, Passenger compartment fuse box fuses 19, 29 and 30
104	20A	Power point
105	20A	Power door lock switches
106	30A	Main light switch, Multi-function switch
107	50A	Passenger compartment fuse box fuses 1, 2, 3, 4, 12, 13, 14 and 15
108	40A	Fuel heater (diesel engine only)
	20A	Fuel pump module (gasoline engine only)
109	40A	Power window
110	30A	Windshield wiper
111	30A	Body builder relay, Parking lamps
112	40A	Blower motor
113	30A	Heated seats, Air-Ride seat
114	20A	Aftertreatment DCU
115	20A	Ignition switch, Passenger compartment fuse box fuses 8, 9, 10 and 11
116	30A	Left/Right turn relays, Back up lamp relay
117	20A	Stop lamps
118	60A	Hydraulic brake vehicles (trailer tow package only)
601	60A	Trailer socket
602	60A	Air brake trailer tow fuse block
	30A	Hydraulic brakes pump motor 2
201	—	Windshield washer relay
202	—	Wiper high/low relay
203	—	Wiper run/park relay

Fuse/Relay Location	Fuse Amp Rating	Protected Circuits
204	—	Windshield wiper relay
205	—	Body builder relay, right turn
206	—	Body builder relay, left turn
207	—	ABS event relay (hydraulic brake vehicles only)
208	—	Body builder relay, back up lamps relay
209	—	Auxiliary stop lamp relay
301	—	Fuel heater/Fuel transfer pump relay (diesel engine only)
	—	Fuel pump module (gasoline engine only)
302	—	Body builder relay, parking lamps relay
303	—	Blower motor relay
304	—	DEF (Urea) line heaters relay (diesel engine only)
	—	Powertrain control module power VPWR1 (gasoline engine only)
Individual Maxi Fuse Holder in Engine Compartment		
Fuse/Relay Location	Fuse Amp Rating	Protected Circuits
9925	30A	Hydraulic brakes pump motor 1

Passenger Compartment Fuse Panel



The fuse box is located behind the passenger airbag cover and can be accessed through the glove box.

Fuse/Relay Location	Fuse Amp Rating	Protected Circuits
1	20A	Horn
2	15A	Flasher relay
3	20A	Power point
4	10A	Data Link Connector (DLC), Engine diagnostic connector, Parking brake warning
5	15A	Run relay
6	—	Not used
7	—	Not used
8	5A	Radio, GEM
9	5A	Power window relay
10	15A	Heated mirrors
11	5A	Wiper and washer systems
12	10A	Transmission shift selector
13	20A	Radio/SYNC®, Power mirrors
14	10A	Interior lamp relay
15	10A	Interior lamp relay

Fuse/Relay Location	Fuse Amp Rating	Protected Circuits
16	15A	High beams, Indicator
17	—	Not used
18	5A	Dimmer switch, Interior lighting
19	15A	Engine control (diesel engine only)
20	5A	Starting system
21	10A	DRL resistor
22	15A	Air horn, Air suspension dump, Two-speed axle, Driver-controlled locking differential
23	10A	Flasher relay
24	15A	Hydraulic brakes relay, Fuel heater relay (diesel engine only), Air dryer
25	10A	Blower motor relay coil
26	10A	Right-hand low beam headlight
27	—	Not used
28	10A	Left-hand low beam headlight
29	10A	Cluster, GEM
30	15A	Allison electronic transmission
31	15A	Mirror fold relay
Relay 1	—	Interior lamps
Relay 2	—	Not used
Relay 3	—	Horn
Relay 4	—	Not used
Relay 5	—	Not used

Relay Center

The relay center is located along the passenger side A-pillar on the right side of the footwell.

Relay Location	Relay Description
R1	Spring applied hydraulic release warning chime module or PCM power VPWR 2, 3 and 4
R2	A/C compressor clutch
R3	Power windows
R4	Flasher (standard/LED)
R5	Upfitter relay 1
R6	Upfitter relay 2
R7	Headlights
R8	Spare
R9	Upfitter relay 3
R10	Starter
R11	DCU (diesel engine only)
R12	Two-speed axle/Differential lock
R13	Door lock
R14	Air tank moisture valve
R15	DRL #1
R16	Heated mirrors
R17	Spare
R18	Upfitter relay 4

Relay Location	Relay Description
R19	Shift interlock/EPRNDL display
R20	Selective Catalyst Reduction (SCR) system (NOx) (diesel engine only)
R21	Run
R22	Door unlock
R23	ABS warning indicator
R24	DRL #2
R25	Park lights
R26	Spare

Trailer Tow Relays (If Equipped)

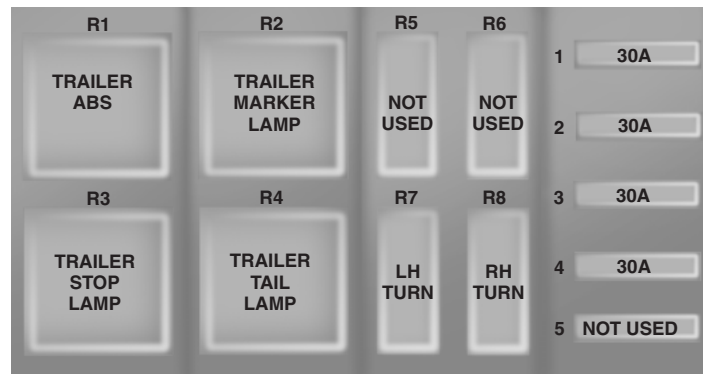

Fuse/Relay Location	Fuse Amp Rating	Protected Circuits
1	30A*	Trailer tow ABS feed (non electric trailer brake vehicles only)
2	30A*	Trailer tow park/marker lamps
3	30A*	Trailer tow stop lamps

Fuse/Relay Location	Fuse Amp Rating	Protected Circuits
4	30A*	Trailer tow turn/stop lamps (combined)
		Trailer tow turn lamps (separate)
5	—	Not used
R1	—	Trailer tow ABS relay (non electric trailer brake vehicles only)
R2	—	Trailer tow marker lamp relay
R3	—	Trailer tow stop lamp relay
R4	—	Trailer tow tail lamp relay
R5	—	Not used
R6	—	Not used
R7	—	Trailer tow left turn lamp relay
R8	—	Trailer tow right turn lamp relay
*Maxi fuse		

Inline Fuses

Your vehicle may have several inline fuses located in, or on, the battery cables located in the battery box (depending on application).

- All vehicles equipped with an Allison transmission have a 10 amp fuse located in the clean power cables located in the battery box.
- All vehicles have a 30 amp fuse located in the clean power cables located in the battery box.
- All vehicles equipped with an Eaton transmission have a 30 amp fuse located in the clean power cables located in the battery box.
- All vehicles equipped with hydraulic brakes have a 40 amp fuse located in the clean power cables located in the battery box. In addition, another 30 amp fuse is located in a fuse holder just above the power distribution center located in the vehicle's engine compartment.

GENERAL INFORMATION

WARNING: Making modifications to various parts, components and systems of the vehicle, such as brake and steering systems, can adversely affect the quality, reliability and operation of your vehicle and could result in property damage, personal injury or death. Such modifications must be avoided.



WARNING: Failure to properly perform maintenance and servicing procedures could result in vehicle damage, personal injury or death.



WARNING: Take care when performing any maintenance, system check or service on your vehicle. Some of the materials may also be hazardous if used, serviced or handled improperly and could result in property damage, personal injury or death.

Always use care when performing vehicle maintenance, repairs or system checks. Improper or incomplete service could result in the vehicle not working properly which may result in personal injury or damage to the vehicle or equipment. It is the operator's responsibility to see that the vehicle receives proper care and maintenance. If you have any questions about performing service, have the service done by a qualified technician.

Servicing Guidelines

When servicing your vehicle:

- always wear safety glasses for eye protection.
- always set the parking brake or chock the wheels.
- always use support stands, not a jack, when working under a raised vehicle.
- always turn off the ignition unless a procedure requires the engine to be running.
- always avoid contact with hot metal parts. Allow the components to cool before working with, or around, them.
- always operate the engine in a well-ventilated area.
- do not wear loose-fitting clothing, hanging jewelry, watches or rings.
- do not smoke.
- do not work on the brakes or the clutch unless the proper precautions are taken to avoid inhaling friction material dust.

Quality service parts are available through your dealer. If dealer parts are not used, make sure the replacement parts are of equivalent quality.



WARNING: The use of inferior parts can adversely affect the quality and reliability of your vehicle which, in turn, can result in property damage, personal injury or death.

To avoid damage to the vehicle's electrical components prior to electric welding:

- disconnect both battery cables.
- attach the welder ground cable as close as possible to the part being welded.
- it is recommended that the component be temporarily removed if welding close to an electrical component.

Follow the checks and services in the *Scheduled Maintenance* chapter. Have your dealer or service center inspect your vehicle at least once a year. Remember that regular maintenance and inspections usually prevent serious problems from developing later.

If the owner or operator of the vehicle is a skilled technician and intends on performing the vehicle maintenance and service, he is strongly urged to purchase a service manual.

Electrical System

Periodically inspect electrical connectors on the outside of the cab and on the engine and frame for corrosion and tightness. Exposed terminals, such as the fuel sender, cranking motor, alternator and feed-through studs, should be cleaned and re-coated with a lubricant sealing grease such as Motorcraft® Silicone Brake Caliper Grease and Dielectric Compound XG-3, or equivalent. This should include the ground cable connector for batteries, engine and cab as well as the jump starting stud.

Accessory Feed Connections

Vehicle electrical systems are complex and often include powertrain components, such as engine and transmission controls, instrument panels, ABS, etc. While most systems operate on battery voltage (12 volts), some systems can be as high as 90 volts or as low as five volts. See the *Electrical Circuit Diagram Manuals*, available from your vehicle's manufacturer, to make sure that any additional body lights and accessories are connected to circuits that are both appropriate and not overloaded. No modification should be made to any vehicle control system without first contacting your dealer.

Climate Control System

Have the air conditioning system checked each spring. The refrigerant charge, cleanliness of the condenser-evaporator cores and belt condition are essential to system performance.

When the air conditioning system is being used daily, remove the fresh air filter (if equipped) once each season and check for dirt, lint, etc. Replace the filter if necessary. Vehicles operating in unusually dusty conditions may require more frequent filter inspection and replacement.

Front Axle

Maintaining the front axle alignment to specifications is very important and should only be performed by a qualified technician. Regular inspections should include:

- toe-in inspection and adjustment (if necessary), particularly with radial tires.
- checking for proper tightness of axle mounting U-bolt nuts, attaching or mounting bolts and nuts.
- checking the axle for damage, binding, worn parts and adequate lubrication.
- checking the kingpins for excessive wear. This should also be done during other scheduled maintenance (tire rotation or service, wheel bearing service, alignment, etc.). See the workshop manual for proper procedures.

Toe-in

It is essential that correct toe-in and tire pressure be maintained for optimum tire wear.

Inspecting steer axle tires in the first 3000–10000 service miles (5000–16000 service kilometers) generally shows if tires are wearing normally.

Rapid outside shoulder wear on both tires indicates too much toe-in.

Rapid inside shoulder wear on both tires indicates too much toe-out.

In P&D-type service, left-to-right steer tire tread life differentials up to 40% can be observed depending on routes and other variables.

Follow the tire manufacturer's recommended cold inflation pressure for the tire size, load range (ply rating) and steer axle loading typical for their operation (each steer axle tire equals $\frac{1}{2}$ steer axle loading).

Special applications may warrant a setting based on experience with the type of tire operating loads and conditions. Radial tires are more sensitive to toe-in setting than bias ply tires. While not insensitive to vehicle alignment, fine tuning school bus alignment to line-haul truck standards does not drastically improve tire tread life.

Rear Axle

Regular inspections should include:

- checking for proper tightness of axle mounting U-bolt nuts, attaching or mounting bolts and nuts. See *Spring U-bolt checks* later in this chapter.
- checking the axle for damage, binding, worn parts and adequate lubrication.

NoSpin Detroit Locker Positive Locking Differential

Vehicles equipped with this type differential have the operator's manual supplied with the vehicle. See that manual for maintenance inspections.

Brake System

Note: Persons handling brake linings should follow all precautions listed below:

**WARNING:**

1. Always wear a respirator approved by the National Institute of Occupational Studies of Health (NIOSH) or Mine Safety and Appliance (MSA) during all brake service procedures. Wear the respirator from removal of the wheels through assembly.
2. **Never** use compressed air or dry brushing to clean brake parts or assemblies.
3. Clean brake parts and assemblies in open air. During assembly, carefully place all parts on the floor to avoid getting dust in the air. Use an industrial vacuum cleaner with a HEPA filter system to clean dust from the brake drums, backing plates and other brake parts. After using the vacuum, remove any remaining dust with a rag soaked in water and wrung until nearly dry.
4. **Never** use compressed air or dry sweeping to clean the work area. Use an industrial vacuum cleaner with a HEPA filter system and rags soaked in water and wrung until nearly dry. Dispose of used rags with care to avoid getting dust in the air. Use an approved respirator when emptying vacuum cleaners and handling used rags.
5. **Worker clean-up:** Wash your hands before eating, drinking or smoking. Vacuum your work clothes after use and then launder them separately, without shaking them, to prevent fiber dust getting into the air.

Your vehicle is equipped with non-asbestos brake linings. However, exposure to excessive amounts of brake material (whether asbestos or non-asbestos, fiberglass, mineral wool, aramid or carbon) may be a serious health hazard.

Air Brakes

WARNING: Do not manually adjust the automatic slack adjusters to correct excessive push rod stroke as it may result in reduced brake effectiveness and a vehicle crash. Excessive push rod stroke indicates that a problem exists with the automatic adjuster, with the installation of the adjuster, or with foundation brake components that manual adjustment does not remedy. Seek service from a qualified facility for excessive push rod stroke.

Inspection and adjustment: Establish a regular schedule for periodic cleaning, lubrication and adjustment inspection based on vehicle use. Exact maintenance intervals are difficult to predetermine since vehicles are used in a wide variety of applications and conditions. If you are uncertain of the proper schedule for your vehicle, contact your dealer.

Regular inspections should include:

- periodic checking (every service interval) of push rod travel or brake adjustment. This is essential for effective braking. Brake chamber push rods on original equipment chambers now incorporate an orange paint marker near the base of the push rod as a stroke indicator to aid in adjustment checks. If the push rod is clean and the brakes are out of adjustment, the orange marker can be seen protruding from the chamber when the brakes are applied.
- checking the brake lining (every service interval). When brake lining or blocks are worn to within 1/16th inch (1.6 millimeters) of rivets, replace the brake linings. This inspection or adjustment should only be performed by a qualified technician and must be in accordance with instructions provided by the service manual.

Do not back off or disconnect the front brakes so that they are less effective, letting the rear brakes do all the stopping of the vehicle. Do not overlook the brakes on the trailer either. Brake condition on the trailer is just as important as the tractor. Proper brake balance on trucks and tractor-trailers is essential for effective braking.

Once a year, the entire brake system must be inspected:

- Rubber components for deterioration. These components should be inspected by a qualified technician and replaced as necessary. Replacement intervals vary according to the severity and length of vehicle service.
- Condition of brake drums, brake chambers and slack adjusters.
- System for air leaks.
- Hose or pipes for rust, damage and deterioration.
- Operation of service and parking brakes.

Some parts such as air brake chamber diaphragm, air compressor and air cleaner should be inspected periodically and replaced if considered unserviceable.

Air dryer: Climactic conditions affect performance of desiccant or after-cooler type air dryers. Maintenance schedules must be established for each specific operation.

The use of an air dryer on a vehicle does not eliminate the need to periodically drain the air reservoirs.

Desiccant air dryer: Inspect for moisture in the air system by opening reservoirs, draincocks or valves and checking for presence of water. The presence of small amounts of water due to condensation is normal and should not be considered as an indication that the dryer is not functioning properly.

The desiccant cartridge should be replaced or rebuilt when it has been determined that the desiccant is contaminated and does not have adequate water absorption capacity. The desiccant change interval may vary. It is generally recommended that the desiccant be replaced every 12 months (yearly). If experience has shown that extended or shortened life has resulted for a particular installation, then the yearly interval can be increased or decreased accordingly.

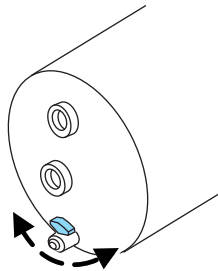

Draining the air brake reservoir:

Completely drain all the air brake reservoirs daily by opening the draincock at the ends of the tanks (Where accessible. Pull-chains are used when the drains are undercab or otherwise inaccessible). Close the draincock after draining. Air tanks equipped with automatic moisture ejector valves may also be drained manually as required to maintain a

dry air system. Contact your dealer if you are unsure of the air reservoir locations or the draining procedure.



WARNING: Failure to drain air brake reservoirs can result in a reduction or loss of braking ability due to fluid accumulation in the reservoir and/or possible freeze-up during cold weather.

Hydraulic Brakes

Establish a regular schedule for periodic cleaning, lubrication and adjustment inspection based on vehicle use. Exact maintenance intervals are difficult to predetermine since vehicles are used in a wide variety of applications and conditions. If you are uncertain of the proper schedule for your vehicle, contact your dealer.

Regular inspections should include:

- checking the brake lining (every service interval). Establish inspection intervals that provide for lining replacement before damage to the disc occurs. Excessive lining wear may expose the backing plate to the disc causing scoring of the disc faces. This inspection should be performed by a qualified technician and must be in accordance with instructions provided by the service manual. Hydraulic brake systems are power-assisted. Braking capabilities are greatly reduced without engine assist.
- proper fluid level. The level should be at the bottom edge of the ring on each reservoir fill port. Do not fill the master cylinder to the top of the reservoir. If fluid level requires attention to maintain a proper master cylinder level, this is an indication of either severe operation (pad wear) or fluid leakage. A more frequent and thorough brake inspection is required.
- brake lines, hoses and fittings. Repair or replace brake line tubes, hoses or fittings as required. Inspect these components every 4000 miles (6000 kilometers):
 - Lines for kinks, dents, corrosion or rupture.
 - Hoses for abrasions, kinks, soft spots or rupture, collapse, cracks, twists or loose frame supports. When replacing a hose, be sure there is adequate clearance to the hose to avoid an abrasion to the new hose.
 - All connections for leaks.

Driveline Parking Brake



WARNING: Use wheel chocks and exercise caution when inspecting under the vehicle. A vehicle roll-away could result in property damage, personal injury or death.

Parking brake adjustment should only be performed by a qualified technician, and in accordance with the instructions in the service manual.

Steering System

WARNING: Failure to maintain the steering system in proper condition can cause reduced steering ability resulting in property damage, personal injury or death.

Note: Have any steering problems immediately corrected by a qualified service technician.

Ask your service technician to examine the steering mechanism. Only minor adjustments may be necessary. Regular inspections should include:

- checking the tie rod, drag link end clamp bolts and ball joints for proper tightness.
- checking for installation and spread of cotter pins and tightness of nuts at both ends of the tie rod and drag link.
- checking that the pitman arm (steering arm at steering gear) mounting is tight and locked. Check system for leaks or hose chafing. Repair immediately, if necessary.
- maintaining proper steering gear and power steering pump lubricant levels.
- checking steering column joint bolts and steering linkage, particularly for body-to-chassis clearance.

Steering Column Joint Bolts

As a good maintenance practice, it is recommended that steering column joint bolts be checked for tightness every 60000 miles (96000 kilometers) or annually, whichever occurs first. DO NOT OVERTIGHTEN.

Hydraulic System

Whenever the power steering's hydraulic system has been drained and refilled for any reason, air must be bled from the system before returning the vehicle to service. Failure to properly bleed the hydraulic system can result in degradation of power system performance.

Consult your dealer who is aware of the proper procedures for filling and bleeding the system.

Catalytic Converter (Diesel Engine)

Note: If your vehicle is equipped with a catalytic converter/muffler, **do not** blend waste oil with diesel fuel. Operate only on ultra low sulfur (less than 15 parts per million sulfur) diesel fuel with a cetane value of 45 or higher.

If your diesel engine is equipped with a catalytic converter, it is important to review the maintenance schedule to make sure proper functioning of the catalytic converter. Also, take precautions not to damage the catalytic converter when servicing your engine or storing your vehicle.

Diesel Exhaust Fluid (DEF), Diesel Particulate Filter (DPF) and Select Catalyst Reduction (SCR) System

See your engine operator's manual for information regarding DEF, DPF and SCR system service.

Air Induction System

WARNING: When performing maintenance to any turbocharged engine with engine air inlet piping disconnected, keep loose clothing, jewelry and long hair away from the engine air inlet piping. A turbocharger compressor air inlet protective shield should be installed over the turbocharger air inlet to reduce the risk of personal injury or death.

Perform a complete inspection of the air induction system annually.

In areas where road salt is used, disassemble the joints of each aluminum component and inspect for salt build-up and presence of chlorine that can cause aluminum particles to flake off and enter the engine combustion chambers. If evidence of corrosion is found (usually at the pipe connections), use a wire brush to clean the inside of the pipes and inside the rubber hoses.

If the intake pipes are pitted at the joint ends, use Motorcraft® Silicone Gasket and Sealant TA-30 to seal the joints. Make sure no excess material is on the inside of the pipes that can be pulled into the engine. If the service condition of the pipes, hoses or clamps is questionable, replace the defective part(s).

Make sure all dust and debris has been cleaned out of the pipes and couplings with a clean, damp rag prior to reassembly.

Chassis-mounted Charge Air Cooler

Visually inspect the core assembly for debris and clogging of external fins with the engine off. Prior to engine operation, remove any debris blocking the core.

- Turbocharger-to-charge air cooler
- Charge air cooler-to-intake manifold pipe
- Mounting bracket
- Chassis-mounted charge air cooler core

Inspect air intake piping:

- Check for accumulation of salt deposits (where applicable).
If present, disassemble and clean the complete air intake piping system. If the intake piping is pitted, use Motorcraft® Silicone Gasket and Sealant TA-30 to seal joints against leakage.
- Check for loose hoses and clamps.
- Check for ruptured or collapsed hoses.
- Check air cleaner housing for cracks.

Suspension Inspection

Note: Do not adjust air suspension height to any setting other than the specified setting. Altering the height setting changes the driveline angle and may result in unwarrantable component damage, such as transmission component damage.

Verify drive axle air suspension height and height control valve performance at engine oil change intervals.

Periodically check:

- Condition of spring leaves for evidence of fatigue, bending or breakage.
- Condition of suspension mounting brackets and bushings.
- Torque rod mounting fasteners for tightness.
- For proper suspension alignment. This must be maintained at all times.
- U-bolts. After the chassis has been operating under load for 1000 miles (1600 kilometers) or six months (whichever comes first), the U-bolt nuts must be re-torqued. The U-bolt nuts must be re-torqued every 36000 miles (60000 kilometers) thereafter. The U-bolt and nut threads and seats should be cleaned and lubricated to make sure a like new condition when re-torquing.

Note: See *Spring U-bolt check* later in this chapter.

Supporting Your Vehicle for Service

WARNING: Do not use a jack when working under a vehicle. It may give way, causing the vehicle to fall and result in property damage, personal injury or death. Always use floor stands to support the vehicle.

Prepare the vehicle for service repairs by doing the following:

1. Park the vehicle on a level, concrete floor.
2. Set the parking brake and block the wheels to prevent the vehicle from moving.
3. Select a jack with a rated capacity sufficient to lift and hold up the vehicle.
4. Raise the vehicle with the jack applied to the axle(s). DO NOT use the bumper as a lifting point.
5. Support the vehicle with floor stands under the axle(s). If the axle or the suspension is being serviced, support the vehicle with floor stands under the frame side-members, preferably between the axles.

Frame and Tow Hooks

Your vehicle's chassis is manufactured with frame rails of either HSLA steel or heat-treated steel. Each must be handled in a specific manner to make sure maximum service life. Consult the service manual or your dealer before attempting frame repair or modification.

It is important, particularly on vehicles where the tow hooks are used frequently, to inspect the front and rear tow hooks for damage or a loose mounting.

OPENING AND CLOSING THE HOOD

WARNING: The parking brake must be fully set before opening the hood or possible personal injury may occur.



WARNING: To reduce the risk of the possibility of personal injury, never stand beneath the hood when it is being raised or lowered.



WARNING: If you must leave the engine running while checking under the hood, do not allow any loose clothing, jewelry, hair or other items to get near moving engine components or possible personal injury may occur.

The hood and fenders are held in position by a latch located on each fender.

Before opening the hood, set the parking brake, shift into position **N** (automatic transmission) or first (manual transmission) and turn the engine off.

To open the hood:

1. Lift up on the bottom of each latch.

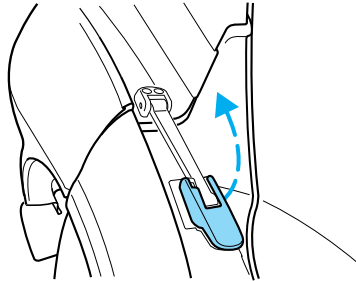

2. Pull the bottom of each latch away from the fender.

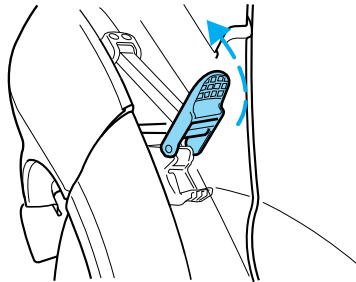

3. Tilt the hood forward until stopped by the retaining cables.

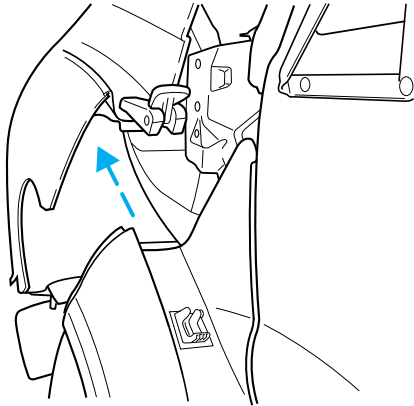

To lower the hood:

1. Push the hood rearward at the top center of the hood above the grille until closed.
2. Engage the latch on each fender.
3. Push down on the bottom of each latch until locked.

ENGINE OIL DIPSTICK

Diesel Engine

See your engine operator's manual for information on the engine oil dipstick.

Gasoline Engine

- A. MIN
- B. MAX



ENGINE OIL CHECK**Diesel Engine**

See your engine operator's manual for information on checking and adding engine oil as well as engine oil specifications, capacities and required maintenance.

Gasoline Engine***Checking the Engine Oil***

1. Make sure the vehicle is on level ground.
2. Turn the engine off and wait 15 minutes for the oil to drain into the oil pan.
3. Set the parking brake and make sure the gearshift is securely latched in position **P**.
4. Open the hood. Protect yourself from engine heat.
5. Locate and carefully remove the engine oil level dipstick.
6. Wipe the dipstick clean. Insert the dipstick fully, then remove it again.
 - If the oil level is between the lower and upper holes, the oil level is acceptable. **DO NOT ADD OIL.**
 - If the oil level is below the lower hole, add enough oil to raise the level within the lower and upper holes.
 - Oil levels above the upper hole may cause engine damage. Some oil must be removed from the engine by an authorized dealer.
7. Put the dipstick back in and make sure it is fully seated.

Adding Engine Oil

Note: Do not remove the engine oil level dipstick or the filler cap when the engine is running.

Note: Do not add engine oil further than the MAX mark. Oil levels above the MAX mark may cause engine damage.



Only use oils certified for gasoline engines by the American Petroleum Institute (API). An oil with this trademark symbol conforms to the current engine and emission system protection standards and fuel economy requirements of the International Lubricants Specification Advisory Council (ILSAC), comprised of U.S. and Japanese automobile manufacturers.

1. Check the engine oil level.

2. If the engine oil level is not within the normal range, add engine oil that meets Ford specifications. See *Capacities and Specifications* for more information. Remove the engine oil filler cap and use a funnel to pour the engine oil into the opening.
3. Recheck the engine oil level. Make sure the oil level is not above the normal operating range on the engine oil level dipstick.
4. Install the dipstick and make sure it is fully seated.
5. Fully install the engine oil filler cap by turning the filler cap clockwise until three clicks are heard or until the cap is fully seated.

ENGINE COOLANT CHECK

Diesel Engine

See your engine operator's manual for information on checking and adding engine coolant.

Fan Clutches



WARNING: Stay clear of the fan and fan area while the engine is running or possible personal injury may occur.

Your vehicle's cooling system is equipped with a viscous fan clutch which:

- Helps control cooling, increases performance, improves fuel economy and reduces noise.
- Is controlled by bimetallic spring sensors. Do not tamper with these sensors as this may change their calibration or keep the fan clutch from operating at all.

Gasoline Engine

Checking the Engine Coolant

The concentration and level of engine coolant should be checked at the intervals listed in the *Scheduled Maintenance* chapter.

Note: Make sure that the level is between the MIN and MAX marks on the coolant reservoir.

Note: Coolant expands when it is hot. The level may extend beyond the MAX mark.

If the level is at the MIN mark, add coolant immediately. See *Adding engine coolant* in this section.

Note: For best results, coolant concentration should be tested with a refractometer such as Rotunda tool 300-ROB75240E available from your dealer. Ford does not recommend the use of hydrometers or coolant test strips for measuring coolant concentrations.

Note: Automotive fluids are not interchangeable; do not use engine coolant, antifreeze or windshield washer fluid outside of its specified function and vehicle location.

Adding Engine Coolant



WARNING: Do not add engine coolant when the engine is hot. Steam and scalding liquids released from a hot cooling system can burn you badly. Also, you can be burned if you spill coolant on hot engine parts.



WARNING: Do not put engine coolant in the windshield washer fluid container. If sprayed on the windshield, engine coolant could make it difficult to see through the windshield.



WARNING: To reduce the risk of personal injury, make sure the engine is cool before unscrewing the coolant pressure relief cap. The cooling system is under pressure; steam and hot liquid can come out forcefully when the cap is loosened slightly.



WARNING: Do not add coolant further than the MAX mark.

Note: Do not use stop leak pellets or cooling system sealants or additives as they can cause damage to the engine cooling and heating systems. This damage would not be covered under your vehicle's warranty.

Note: During normal vehicle operation, the engine coolant may change color from orange to pink or light red. As long as the engine coolant is clear and uncontaminated, this color change does not indicate the engine coolant has degraded nor does it require the engine coolant to be drained, the system to be flushed, or the engine coolant to be replaced.

- DO NOT MIX different colors or types of coolant in your vehicle. Make sure the correct coolant is used. Mixing of engine coolants may harm your engine's cooling system. The use of an improper coolant may harm engine and cooling system components and may void the warranty.

- In case of emergency, a large amount of water without engine coolant may be added in order to reach a vehicle service location. In this instance, the cooling system must be drained, chemically cleaned with Motorcraft® Premium Cooling System Flush, and refilled with prediluted engine coolant as soon as possible. Water alone (without engine coolant) can cause engine damage from corrosion, overheating or freezing.
- Do not use alcohol, methanol, brine or any engine coolants mixed with alcohol or methanol antifreeze (coolant). Alcohol and other liquids can cause engine damage from overheating or freezing.
- Do not add extra inhibitors or additives to the coolant. These can be harmful and compromise the corrosion protection of the engine coolant.

Unscrew the cap slowly. Any pressure escapes as you unscrew the cap.

Add prediluted engine coolant meeting the Ford specification.

See *Capacities and Specifications* for more information.

Whenever coolant has been added, the coolant level in the coolant reservoir should be checked the next few times you drive the vehicle. If necessary, add enough prediluted engine coolant to bring the coolant level to the proper level.

Recycled Engine Coolant

Ford Motor Company does not recommend the use of recycled engine coolant since a Ford-approved recycling process is not yet available.

Always dispose of used automotive fluids in a responsible manner. Follow your community's regulations and standards for recycling and disposing of automotive fluids.

Severe Climates

If you drive in extremely cold climates:

- It may be necessary to have a Ford authorized dealer increase the coolant concentration above 50%.
- A coolant concentration of 60% provides improved freeze point protection. Engine coolant concentrations above 60% decrease the overheat protection characteristics of the engine coolant and may cause engine damage.

If you drive in extremely hot climates:

- It may be necessary to have a Ford authorized dealer decrease the coolant concentration to 40%.
- A coolant concentration of 40% provides improved overheat protection. Engine coolant concentrations below 40% decrease the corrosion and freeze protection characteristics of the engine coolant and may cause engine damage.

Vehicles driven year-round in non-extreme climates should use prediluted engine coolant for optimum cooling system and engine protection.

What You Should Know About Fail-Safe Cooling (If Equipped) (Gasoline Engine Only)



WARNING: If fail-safe cooling activates, pull off the road as soon as safely possible and turn the engine off. The engine may automatically shut off while driving without further indication.

If the engine coolant supply is depleted, this feature allows the vehicle to be driven temporarily before incremental component damage is incurred. The fail-safe distance depends on ambient temperatures, vehicle load and terrain.

How Fail-Safe Cooling Works

If the engine begins to overheat:

- The engine coolant temperature gauge moves to the red (hot) area.
- The information display indicates the engine is overheating.
- The service engine soon indicator illuminates.

If the engine reaches a preset over-temperature condition, the engine automatically switches to alternating cylinder operation. Each disabled cylinder acts as an air pump and cools the engine.

When Fail-Safe Mode Is Activated



WARNING: Never remove the coolant reservoir cap while the engine is running or hot.

Note: Driving the vehicle without repairing the engine problem increases the chance of engine damage. Take your vehicle to an authorized dealer as soon as possible.

You have limited engine power when in the fail-safe mode, so drive the vehicle with caution. The vehicle is not able to maintain high-speed operation and the engine runs rough. Remember that the engine is capable of completely shutting down automatically to prevent engine damage; therefore:

1. Pull off the road as soon as safely possible and turn off the engine.
2. Arrange for the vehicle to be taken to an authorized dealer.
3. If this is not possible, wait a short period for the engine to cool.
4. Check the coolant level and replenish if low.
5. Restart the engine and take your vehicle to an authorized dealer.

TRANSMISSION FLUID CHECK**Allison Automatic Transmissions**

See your *Allison Automatic Transmission Operator's Manual* for scheduled transmission fluid checks and change intervals. Your transmission does not consume fluid. However, the fluid level should be checked if the transmission is not working properly, i.e., if the transmission slips or shifts slowly or if you notice some sign of fluid leakage.

Automatic transmission fluid expands when warmed. To obtain an accurate fluid check, drive the vehicle until it is at normal operating temperature (approximately 20 miles [30 kilometers]). Verify that the transmission fluid temperature gauge, located on the instrument cluster, is within the normal range.

1. Drive the vehicle 20 miles (30 kilometers) or until it reaches normal operating temperature.
2. Park the vehicle on a level surface and engage the parking brake.
3. With the engine running, parking brake engaged and your foot on the brake pedal, move the gearshift lever through all of the gear ranges. Allow sufficient time for each gear to engage.
4. Latch the gearshift lever in position **N** or **P** and leave the engine running.
5. Remove the dipstick, wiping it clean with a clean, dry, lint-free rag.
6. Install the dipstick making sure it is fully seated in the filler tube.
7. Remove the dipstick and inspect the fluid level. The fluid should be in the designated area for normal operating temperature or ambient temperature.

If you must add transmission fluid, see your *Allison Automatic Transmission Operator's Manual* for the correct fluid type. **Use of a non-approved automatic transmission fluid may cause internal transmission component damage.**

Fluid levels above the safe range may result in transmission failure. An overfill condition of transmission fluid may cause shift or engagement concerns or possible damage.

TorqShift® Automatic Transmission

See the *Scheduled Maintenance* chapter for scheduled intervals for fluid checks and changes. Your transmission does not consume fluid. However, the fluid level should be checked if the transmission is not working properly, i.e., if the transmission slips or shifts slowly or if you notice some sign of fluid leakage.

Automatic transmission fluid expands when warmed. To obtain an accurate fluid check, drive the vehicle until it is at normal operating temperature (approximately 20 miles [30 kilometers]). Verify that the transmission fluid temperature gauge, located on the instrument cluster, is within the normal range.

1. Drive the vehicle 20 miles (30 kilometers) or until it reaches normal operating temperature.
2. Park the vehicle on a level surface and engage the parking brake.
3. With the engine running, parking brake engaged and your foot on the brake pedal, move the gearshift lever through all of the gear ranges. Allow sufficient time for each gear to engage.
4. Latch the gearshift lever in position **P** and leave the engine running.
5. Remove the dipstick, wiping it clean with a clean, dry, lint-free rag.
6. Install the dipstick making sure it is fully seated in the filler tube.
7. Remove the dipstick and inspect the fluid level. The fluid should be in the designated area for normal operating temperature or ambient temperature.

Low Fluid Level



Do not drive the vehicle if there is no indication of fluid on the dipstick and the ambient temperature is above 50°F (10°C).

Correct Fluid Level

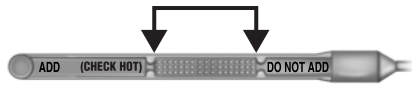

The fluid should be checked at normal operating temperature 196°F-216°F (91°C-102°C) on a level surface. The normal operating temperature can be reached after approximately 20 miles (30 kilometers) of driving.

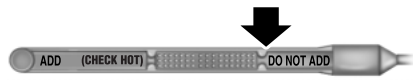
High Fluid Level

Fluid levels above the safe range may result in transmission failure. An overfill condition of transmission fluid may cause shift or engagement concerns and possible damage.

High fluid levels can be caused by an overheating condition.

Adjusting Automatic Transmission Fluid Levels

Note: Use of a non-approved automatic transmission fluid may cause internal transmission component damage.

Before adding any fluid, make sure the correct type is used. The type of fluid used is normally indicated on the dipstick handle and also in the *Capacities and Specifications* chapter.

If necessary, add fluid in ½ pint (250 ml) increments through the filler tube until the level is correct.

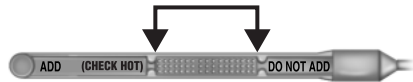

If an overfill occurs, excess fluid should be removed by a qualified technician.

Note: An overfill condition of transmission fluid may cause shift or engagement concerns or possible damage.

Do not use supplemental transmission fluid additives, treatments or cleaning agents. The use of these materials may affect transmission operation and result in damage to internal transmission components.

Manual Transmissions

Note: Use of a non-approved transmission fluid may cause internal transmission component damage.

See the *Scheduled Maintenance* chapter for scheduled intervals for fluid checks and changes.

Your manual transmission may be filled with an optional synthetic fluid which allows the use of extended service intervals. A tag on the filler plug identifies the use of the synthetic fluid.

Only use fluid that meets manufacturer specifications. See *Technical specifications* in the *Capacities and Specifications* chapter.

Checking Fluid Level

1. Park the vehicle on level ground.
2. Set the parking brake, shift into first gear and turn the engine off.
3. Clean any dirt from around the filler plug.
4. Remove the filler plug and inspect the fluid level. The fluid level should be at the bottom of the filler plug opening.
5. Add fluid, if necessary, through the filler plug opening.
6. Clean and install the filler plug securely.

Changing Fluid

Drain and refill your transmission fluid while it is warm.

1. Park the vehicle on level ground.
2. Set the parking brake, shift into first gear and turn the engine off.
3. Clean any dirt from around the filler and drain plugs.
4. Remove the filler and drain plugs and drain the fluid into a suitable container. Dispose of all used automotive fluids in a responsible manner following your local authorized standards.
5. Clean and install the drain plug securely.
6. Add fluid through the filler plug opening.
7. Clean and install the filler plug securely.

DRIVESHAFT

Check the universal joints for any evidence of wear or looseness at the regular lubrication interval. Stop the vehicle immediately, should driveshaft vibrations occur, to avoid possible hazardous consequences or damage to other components.

REAR AXLE FLUID

Your rear axle may be filled with an optional synthetic lubricant which allows the use of extended service intervals. A tag on the filler plug identifies the use of the synthetic lubricant.

Only use a lubricant that meets manufacturer specifications. See the *Capacities and Specifications* chapter. **Use of a non-approved rear axle lubricant may cause internal axle component damage.**

Checking the Fluid Level

See the *Scheduled Maintenance* chapter for rear axle lubricant level check intervals.

1. Park the vehicle on level ground.
2. Set the parking brake and shift into position **N** or **P** (automatic transmission), or first gear (manual transmission). Turn the engine off.
3. Clean any dirt from around the rear axle filler plug.
4. Remove the filler plug and inspect the lubricant level. It should be at the bottom of the filler plug opening.
5. Add lubricant, if necessary, through the filler plug opening.
6. Clean and install the filler plug securely.

Changing the Fluid

See the *Scheduled Maintenance* chapter for rear axle lubricant change intervals.

1. Drain the rear axle while the lubricant is warm.
2. Park the vehicle on level ground.
3. Set the parking brake and shift into position **N** or **P** (automatic transmission), or first gear (manual transmission). Turn the engine off.
4. Clean any dirt from around the rear axle filler and drain plugs.
5. Remove the filler and drain plugs. Drain the lubricant into a suitable container. Dispose of all used automotive fluids in a responsible manner following your local authorized standards.
6. Clean and install the drain plug securely.
7. Add lubricant through the filler plug opening.
8. Clean and install the filler plug securely.

SPRING U-BOLT CHECKS

Check U-bolt nuts and re-torque every 36000 miles (60000 kilometers) after initial 1000 mile (1600 kilometer) re-torque. The U-bolt and nut threads and seats should be cleaned and lubricated to make sure peak condition when re-torqued.

U-bolt Nut Torque

Suspension	ft-lb	N•m
Front axle – 8500 lb (3856 kg)	180-200	244-271
Front axle – 10000 lb (4536 kg) and higher	260-300	353-407
Rear axle with multi-leaf	260-300	353-407
Rear axle with IROS air suspension	370-400	502-542
Rear axle with Hendrickson air suspension	400-450	542-610

See air suspension U-bolt re-torquing and installation information below.

Air Suspension U-bolt Checks and Re-torquing Procedures

1. Inspect the threads of the U-bolt and nut for rust and debris. Clean the threads if contaminated.
2. Using a torque wrench, determine if any nuts can be turned with a force below the specified torque.
3. Using the lowest discovered torqued nut as a starting point, re-tighten the nuts using the sequence listed under *Air suspension U-bolt and U-bolt nut installation*.

Air Suspension U-bolt and U-bolt Nut Installation

1. Inspect the threads of the U-bolt and nut for rust and debris. Clean the threads if contaminated.
2. Install the U-bolts and nuts and torque the nuts to seat the cap flat which is about 18 ft-lb (25 N•m) using a diagonal pattern. Use the same diagonal pattern for each of the following U-bolt nut re-torque steps.
3. Tighten U-bolt nuts in increments of 74 ft-lb (100 N•m) until tightened to final torque for the particular suspension.

BRAKE FLUID CHECK

WARNING: Brake fluid is toxic. If brake fluid contacts the eyes, flush eyes with running water for 15 minutes. Seek medical attention if irritation persists. If taken internally, drink water and induce vomiting. Seek medical attention immediately.



WARNING: If you use a brake fluid that is not DOT 3, you will cause permanent damage to your brakes.



WARNING: Do not let the reservoir for the master cylinder run dry. This may cause the brakes to fail.

Check and refill the Full Power brake fluid reservoir using the following procedure. See the *Scheduled Maintenance* chapter for the service interval.

1. Clean the reservoir caps before removal to prevent dirt or water from entering the reservoir.
2. Visually inspect the fluid level. It should be at the bottom of the fill ports.
3. Add brake fluid, if necessary, from a clean, unopened container until the level reaches the bottom of the fill ports. Do not fill above this line.

Only use a DOT 3 brake fluid certified to meet manufacturer specifications. See the *Capacities and Specifications* chapter.

CLUTCH FLUID AND LINKAGE**Clutch Fluid**

WARNING: Carefully read cautionary information on product label. For MEDICAL EMERGENCY INFORMATION, contact a physician or Poison Control Center immediately; on Ford-Motorcraft® products call: 1-800-959-3673 (FORD). Failure to follow these instructions may result in personal injury.

Use only a DOT 3 brake fluid designed to meet manufacturer specifications. See the *Capacities and Specifications* chapter.

During normal operation, the fluid level in the clutch reservoir should remain constant. If the fluid level drops, fill to the step in the reservoir.

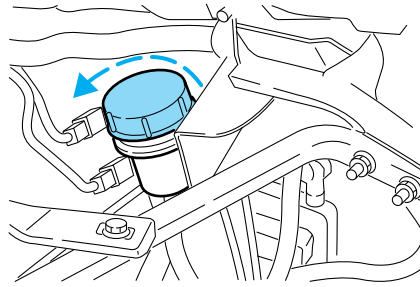

1. Set the parking brake, shift into first gear and turn the engine off.
2. Open the hood.
3. Clean the reservoir cap before removal to prevent dirt and water from entering the reservoir.
4. Remove cap and rubber diaphragm from reservoir.
5. Add fluid, if necessary, until it reaches the step in the reservoir.
6. Reinstall rubber diaphragm and cap onto reservoir.

See the *Scheduled Maintenance* chapter for service intervals.

Clutch Linkage

Lubricate the clutch linkage using the following procedure. Use a grease which meets manufacturer specifications. See the *Capacities and Specifications* chapter.

Transmission and clutch removed for clarity.

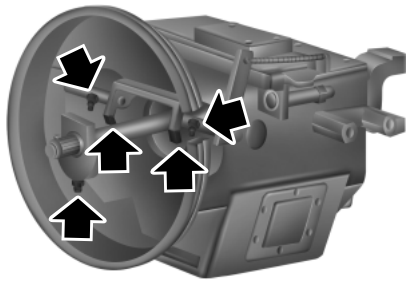

1. Set the parking brake, shift into first gear and turn the engine off.
2. Remove the inspection cover from the clutch housing.
3. Lubricate the clutch release bearing (one location) and the clutch release shaft (two locations) grease fittings with a grease gun.
4. Lubricate the clutch release wear pads (two locations) where they contact the clutch release bearing with a brush or similar tool.
5. Reinstall the inspection cover.

See the *Scheduled Maintenance* chapter for service intervals.

POWER STEERING FLUID CHECK

Note: To avoid damage to the power steering system, do not operate the vehicle with a low power steering fluid level.

Note: If adding fluid is necessary, use only the appropriate fluid. See the *Capacities and Specifications* chapter. A low fluid level may indicate a leak in the power steering system. Inspect the power steering system and repair the leak or see your dealer or a qualified technician for service. See the *Scheduled Maintenance* chapter for the recommended service intervals.

Check the fluid level when it is at ambient temperature, 20°F–80°F (-7°C–25°C):

1. Set the parking brake, then start the engine.
2. Shift into position **N** or **P** (if equipped) (automatic transmission) or first gear (manual transmission) and turn the engine off.
3. Open the hood.
4. Clean the top of the power steering fluid reservoir.
5. Remove the dipstick from the reservoir and wipe the dipstick clean.
6. Reinstall the dipstick. Remove it again and check the fluid level.



Check the MAX. COLD side of the dipstick if the fluid is cool or warm to the touch (approximately 68°F–120°F [20°C–49°C]). The fluid level should be within the FULL range. If necessary, add fluid in small amounts, continuously checking the level, until it reaches the proper level.

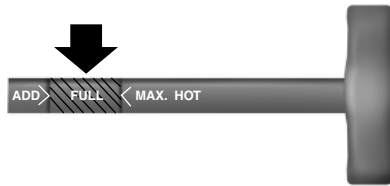

Check the MAX. HOT side of the dipstick if the fluid is too hot to touch (approximately 176°F–230°F [80°C–110°C]). The fluid level should be within the FULL range. If necessary, add fluid in small amounts, continuously checking the level, until it reaches the proper level.

Whenever the dipstick is installed, make sure it is properly seated and tightened securely.

The fluid level can also be checked by looking at the see-through plastic reservoir. Make sure that the fluid is within the minimum and maximum fluid range as marked on the reservoir.

FUEL FILTER**Gasoline Engine**

Your vehicle is equipped with a lifetime fuel filter that is integrated with the fuel tank. Regular maintenance or replacement is not needed.

Diesel Engine

WARNING: Do not drain water separator while engine is running. Fuel may ignite if separator is drained while engine is running or vehicle is moving.

The fuel filter/water separator removes any contaminated particles and water from the fuel before the fuel enters the engine.

See your engine operator's manual for information on draining and replacing the fuel filter.

WASHER FLUID CHECK

WARNING: If you operate your vehicle in temperatures below 40°F (5°C), use washer fluid with antifreeze protection. Failure to use washer fluid with antifreeze protection in cold weather could result in impaired windshield vision and increase the risk of injury or accident.

Add fluid to fill the reservoir if the level is low. Only use a washer fluid that meets Ford specifications. See *Technical specifications* in the *Capacities and Specifications* chapter.

State or local regulations on volatile organic compounds may restrict the use of methanol, a common windshield washer antifreeze additive. Washer fluids containing non-methanol antifreeze agents should be used only if they provide cold weather protection without damaging the vehicle's paint finish, wiper blades or washer system.

CHANGING THE VEHICLE BATTERY

 **WARNING:** This vehicle may be equipped with more than one battery, removal of cable from only one battery does not disconnect the vehicle electrical system. Be sure to disconnect cables from all batteries when disconnecting power. Failure to do so may cause serious personal injury or property damage.

 **WARNING:** Batteries normally produce explosive gases which can cause personal injury. Therefore, do not allow flames, sparks or lighted substances to come near the battery. When working near the battery, always shield your face and protect your eyes. Always provide proper ventilation.

 **WARNING:** When lifting a plastic-cased battery, excessive pressure on the end walls could cause acid to flow through the vent caps, resulting in personal injury and/or damage to the vehicle or battery. Lift the battery with a battery carrier or with your hands on opposite corners.

 **WARNING:** Keep batteries out of reach of children. Batteries contain sulfuric acid. Avoid contact with skin, eyes or clothing. Shield your eyes when working near the battery to protect against possible splashing of acid solution. In case of acid contact with skin or eyes, flush immediately with water for a minimum of 15 minutes and get prompt medical attention. If acid is swallowed, call a physician immediately.

 **WARNING:** Battery posts, terminals and related accessories contain lead and lead compounds. Wash hands after handling.

Note: If your battery has a cover/shield, make sure it is reinstalled after the battery has been cleaned or replaced.

Note: Electrical or electronic accessories or components added to the vehicle by the dealer or the owner may adversely affect battery performance and durability.

Your vehicle is equipped with two or three maintenance-free batteries mounted in a covered tray located on the left frame rail. The covered battery tray, depending upon application, may also have one or two steps attached.

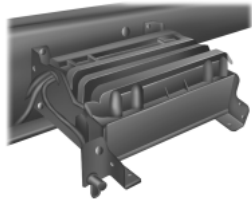

Covered battery tray shown (battery tray with steps similar). The two rubber straps on top of the cover must be pulled up and moved to the side of the battery in order to remove the lid.

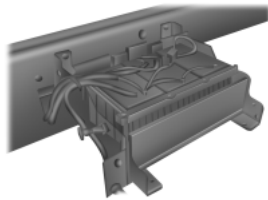

Battery tray with cover removed.

For longer, trouble-free operation, keep the top of the battery clean and dry. Also, make certain the battery cables are always tightly fastened to the battery terminals.

If you see any corrosion on the battery or terminals, remove the cables from the terminals and clean with a wire brush. You can neutralize the acid with a solution of baking soda and water.

It is recommended that the negative battery cable terminal be disconnected from the battery if you plan to store your vehicle for an extended period of time. This will minimize the discharge of your battery during storage.

If the engine cranks but does not start, remove the battery box cover and check the 40 amp inline fuse located on the battery cable above the battery.

Because your vehicle's engine is electronically controlled by a computer, some control conditions are maintained by power from the battery. When the battery is disconnected or a new battery is installed, the engine must relearn its idle and fuel trim strategy for optimum driveability and performance. To begin this process:

1. With the vehicle at a complete stop, set the parking brake.
2. Put the gearshift in position **P** (automatic transmission) or neutral (manual transmission), turn off all accessories and start the engine.
3. Run the engine until it reaches normal operating temperature.
4. Allow the engine to idle for at least one minute.
5. Turn the A/C on and allow the engine to idle for at least one minute.

6. Release the parking brake. With your foot on the brake pedal and with the A/C on, put the vehicle in position **P** (automatic transmission) or neutral (manual transmission) and allow the engine to idle for at least one minute. **Note:** If you do not allow the engine to relearn its idle trim, the idle quality of your vehicle may be adversely affected until the idle trim is eventually relearned.
7. Drive the vehicle to complete the relearning process.

If the battery has been disconnected or a new battery has been installed, the clock and radio settings must be reset once the battery is reconnected.

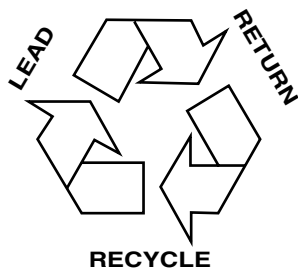

Always dispose of automotive batteries in a responsible manner. Follow your local authorized standards for disposal. Call your local authorized recycling center to find out more about recycling automotive batteries.

CHECKING THE WIPER BLADES

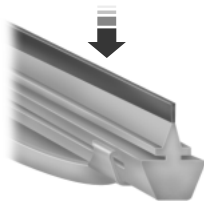

Run the tip of your fingers over the edge of the blade to check for roughness.

Clean the wiper blades with washer fluid or water applied with a soft sponge or cloth.

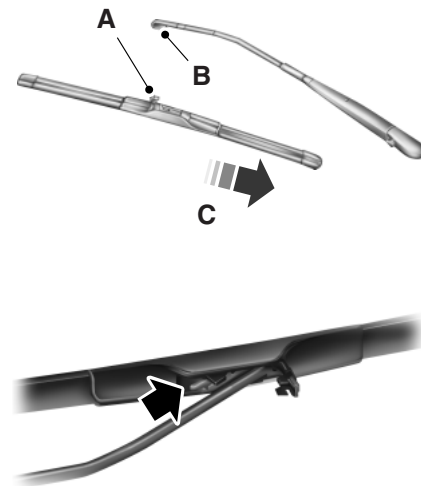
CHANGING THE WIPER BLADES

1. To remove the wiper blade, pull the wiper arm away from the vehicle. Pry open the lock cover (A) with your thumb to release the blade.
2. Press the retaining clip to disengage the wiper blade, then pull the wiper blade down (C) toward the windshield to remove it from the arm.
3. To install the new wiper blade, insert the wiper blade into the wiper arm hook (B).
4. While holding the wiper arm, push the wiper blade up and away from the windshield.
5. Close the lock cover.

Replace wiper blades at least once per year for optimum performance.

Poor wiper quality can be improved by cleaning the wiper blades and the windshield. See *Cleaning the windows and wiper blades* in the *Vehicle Care* chapter.

To prolong the life of the wiper blades, it is highly recommended to scrape off the ice on the windshield before turning on the wipers. The layer of ice has many sharp edges and can damage the micro edge of the wiper rubber element.

AIR FILTER CHECK**Diesel Engine**

See your engine operator's manual for information on the engine air filter.

Gasoline Engine

Note: Do not start your engine with the air cleaner removed and do not remove it while the engine is running.

Note: Failure to use the correct air filter element may result in severe engine damage. The customer warranty may be void for any damage to the engine if the correct air filter element is not used.

See the *Scheduled Maintenance* chapter for the appropriate intervals for changing the air filter element.

When changing the air filter element, use only the Motorcraft® air filter element listed. See *Motorcraft® part numbers* in the *Capacities and Specifications* chapter.

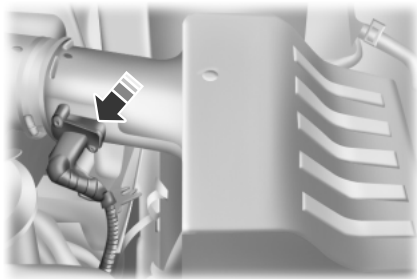

1. Locate and disconnect the mass air flow sensor electrical connector on the air outlet tube.

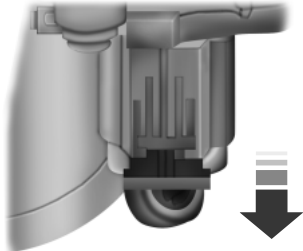

2. Reposition the locking clip on the connector (connector shown from below for clarity). Squeeze the connector and pull it off of the air outlet tube.

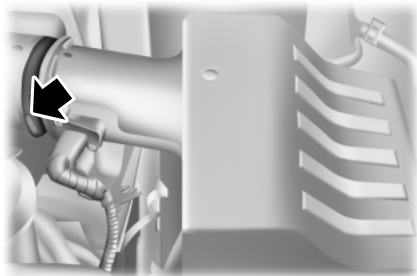

3. Clean the area around the air tube-to-air cover connection to prevent debris from entering the system. Loosen the bolt on the air tube clamp so the clamp is no longer snug to the air tube. It is not necessary to completely remove the clamp.
4. Pull the air tube off the air cleaner housing.

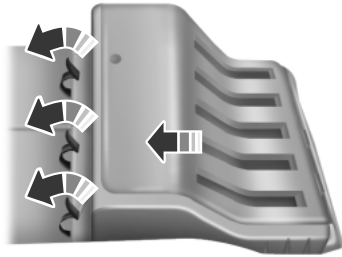

5. Release the three clamps that secure the cover to the air filter housing. Push the air filter cover toward the center of the vehicle, and up slightly, to release it.

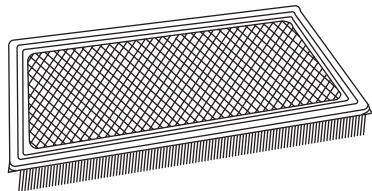

6. Remove the air filter element from the air filter housing.
7. Install a new air filter element.



8. Replace the air filter housing cover and secure the clamps. Be careful not to crimp the filter element edges between the air filter housing and cover and make sure that the tabs on the edge are properly aligned into the slots.

9. Slip the air tube onto the air filter housing and tighten the air tube clamp bolt snugly. Do not overtighten the clamp.

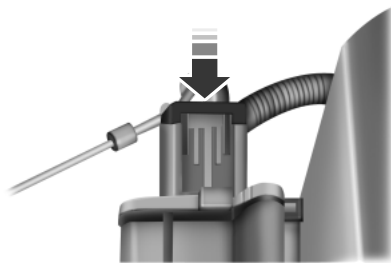

10. Connect the mass air flow sensor electrical connector to the outlet tube. Make sure the locking tab on the connector is in the locked position (connector shown from below for clarity).

ADJUSTING THE HEADLAMPS

The headlamps on your vehicle are properly aimed at the assembly plant. If your vehicle has been in an accident, the alignment of your headlamps should be checked by your authorized dealer.

CHANGING A BULB

Lamp Assembly Condensation

Exterior lamps are vented to accommodate normal changes in pressure. Condensation can be a natural by-product of this design. When moist air enters the lamp assembly through the vents, there is a possibility that condensation can occur when the temperature is cold. When normal condensation occurs, a thin film of mist can form on the interior of the lens. The thin mist eventually clears and exits through the vents during normal operation. Clearing time may take as long as 48 hours under dry weather conditions.

Examples of acceptable condensation are:

- Presence of thin mist (no streaks, drip marks or droplets).
- Fine mist covers less than 50% of the lens.

Examples of unacceptable moisture (usually caused by a lamp water leak) are:

- Water puddle inside the lamp.
- Large water droplets, drip marks or streaks present on the interior of the lens.

Take your vehicle to a dealer for service if any of the above conditions of unacceptable moisture are present.

Replacing Headlamp Bulbs

1. Make sure the headlamp control is in the off position.

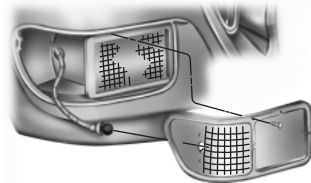

2. Remove the four screws, then move the parking lamp assembly away from the headlamp bulb.

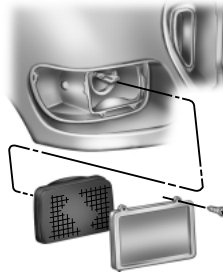

3. Remove the four screws and the retaining bracket from the headlamp bulb.

4. Pull the headlamp bulb out of the housing. Disconnect the electrical connector, then remove the headlamp bulb.

5. Reverse the procedure to install the new bulb.

Replacing Front Parking/Turn Signal/Side Marker Lamp Bulbs

To remove the parking lamp/turn signal bulbs:

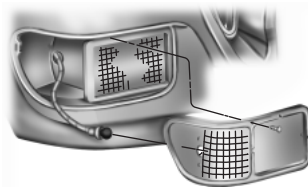

1. Make sure the headlamp control is in the off position and the turn signals are off.

2. Remove the four screws from the lamp assembly.

3. Carefully lower the lamp assembly and pull the bulb socket straight out of the lamp assembly.

4. Carefully pull the bulb straight out of the socket.

5. Reverse the procedure to install the new bulb.

Replacing Front Clearance and Identification Lamp Bulbs

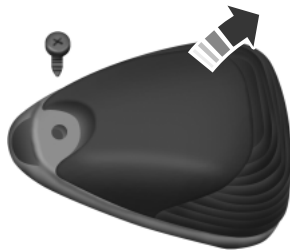

1. Make sure the headlamp control is in the off position.

2. Remove the screw and lens from the lamp assembly.

3. Pull the bulb straight out of the socket.

4. Reverse the procedure to install the new bulb.

Replacing Brake/Tail/Rear Turn Signal/Reverse/License Plate Lamp Bulbs



1. Remove the four screws and the lamp lens from the lamp assembly.
2. Carefully pull the bulb straight out of the socket.
3. Reverse the procedure to install the new bulb.

BULB SPECIFICATION CHART

Replacement bulbs are specified in the chart below. Headlamp bulbs must be marked with an authorized D.O.T. for North America and an E for Europe to make sure lamp performance, light brightness and pattern and safe visibility. The correct bulbs will not damage the lamp assembly or void the lamp assembly warranty and will provide quality bulb illumination time.

Function	Number of Bulbs	Trade Number
Headlamps	2	H6054
Front turn signal lamps	2	1157
Front sidemarker lamps, parking lamps	2 (amber)	194
Brake lamps, tail lamps, stop lamps, rear turn signals lamps, license plate lamps	1 (each side)	1157
Back up lamps	2	1156
Front clearance and identification lamps	5	194
Dome lamp	1	105
To replace all instrument panel lights, see your authorized dealer.		

GENERAL INFORMATION

Your Ford or Lincoln authorized dealer has many quality products available to clean your vehicle and protect its finishes.

CLEANING PRODUCTS

For best results, use the following products or products of equivalent quality:

- Motorcraft® Bug and Tar Remover (ZC-42)
- Motorcraft® Custom Bright Metal Cleaner (ZC-15)
- Motorcraft® Detail Wash (ZC-3-A)
- Motorcraft® Dusting Cloth (ZC-24)
- Motorcraft® Engine Shampoo and Degreaser (U.S. only) (ZC-20)
- Motorcraft® Engine Shampoo (Canada only) (CXC-66-A)
- Motorcraft® Multi-Purpose Cleaner (Canada only) (CXC-101)
- Motorcraft® Premium Glass Cleaner (Canada only) (CXC-100)
- Motorcraft® Premium Quality Windshield Washer Fluid (Canada only) [CXC-37-(A, B, D or F)]
- Motorcraft® Premium Windshield Washer Concentrate (U.S. only) (ZC-32-A)
- Motorcraft® Professional Strength Carpet & Upholstery Cleaner (ZC-54)
- Motorcraft® Spot and Stain Remover (U.S. only) (ZC-14)
- Motorcraft® Ultra-Clear Spray Glass Cleaner (ZC-23)
- Motorcraft® Vinyl Cleaner (Canada only) (CXC-93)
- Motorcraft® Wheel and Tire Cleaner (ZC-37-A)

CLEANING THE EXTERIOR

Wash your vehicle regularly with cool or lukewarm water and a neutral pH shampoo, such as Motorcraft® Detail Wash (ZC-3-A), which is available from your authorized dealer.

- Do not use a commercial or high-pressure wand on the surface or edge of stripes and graphics. This can cause damage to the film and cause the edge of the film to peel away from the vehicle surface.
- Never use strong household detergents or soap, such as dish washing or laundry liquid. These products can discolor and spot painted surfaces.
- Never wash a vehicle that is hot to the touch or during exposure to strong, direct sunlight.

- Always use a clean sponge or car wash mitt with plenty of water for best results.
- Dry the vehicle with a chamois or soft, terry cloth towel in order to eliminate water spotting.
- It is especially important to wash the vehicle regularly during the winter months, as dirt and road salt are difficult to remove and cause damage to the vehicle.
- Immediately remove items such as gasoline, diesel fuel, bird droppings and insect deposits because they can cause damage to the vehicle's paintwork and trim over time. Use Motorcraft® Bug and Tar Remover (ZC-42), which is available from your authorized dealer.
- Remove any exterior accessories, such as antennas, before entering a car wash.
- Suntan lotions and insect repellents can damage any painted surface; if these substances come in contact with your vehicle, wash off as soon as possible.
- If your vehicle is equipped with running boards, use Motorcraft Detail Wash (ZC-3-A), and, as required, Motorcraft Bug and Tar Remover (ZC-42), both as per the directions on the products' labels. To manually dry, use a clean, dry, lint-free towel. Do not use rubber, plastic and vinyl protectant products on the running board surface, as the area may become slippery.

Exterior Chrome

- Wash the vehicle first, using cool or lukewarm water and a neutral pH shampoo, such as Motorcraft® Detail Wash (ZC-3-A).
- Use Motorcraft® Custom Bright Metal Cleaner (ZC-15), available from your authorized dealer. Apply the product as you would a wax to clean bumpers and other chrome parts; allow the cleaner to dry for a few minutes, then wipe off the haze with a clean, dry rag.
- Never use abrasive materials, such as steel wool or plastic pads, as they can scratch the chrome surface.

Underbody

Flush the complete underside of your vehicle frequently. Keep body and door drain holes free from packed dirt.

Rear suspension components may require regular cleaning with a power washer or a thorough rinse with a strong stream of water if the vehicle is operated in dusty or muddy environments. Rear leaf springs or other suspension components may emit squeak or popping noises while operating the vehicle if particles, such as dirt, rocks, or other debris, are present in the components.

Cleaning Plastic Exterior Parts

Use only approved products to clean plastic parts.

- For routine cleaning, use Motorcraft® Detail Wash.
- If tar or grease spots are present, use Motorcraft® Bug and Tar Remover.

WAXING

Regular waxing is necessary to protect your car's paint from the elements. We recommend that you wash and wax the painted surface once or twice a year.

When washing and waxing, park your vehicle in a shaded area out of direct sunlight. Always wash your vehicle before applying wax.

- Use a quality wax that does not contain abrasives.
- Follow the manufacturer's instructions to apply and remove the wax.
- Apply a small amount of wax in a back-and-forth motion, not in circles.
- Do not allow wax to come in contact with any non-body (low-gloss black) colored trim. The wax will discolor or stain the parts over time, such as:
 - Bumpers
 - Grained door handles
 - Side mouldings
 - Mirror housings
 - Windshield cowl area.
- Do not apply wax to glass areas.
- After waxing, your car's paint should feel smooth, and be free of streaks and smudges.

REPAIRING MINOR PAINT DAMAGE

Your authorized dealer has touch-up paint to match your vehicle's color. Take your color code (printed on a sticker in the driver's door jamb) to your authorized dealer to make sure you get the correct color.

- Remove particles, such as bird droppings, tree sap, insect deposits, tar spots, road salt and industrial fallout, before repairing paint chips.
- Always read the instructions before using the products.

CLEANING THE ENGINE

Note: To prevent damage to the engine control module, never spray-wash it directly. Never spray any connector.

Engines are more efficient when they are clean because grease and dirt build-up keep the engine warmer than normal.

When washing:

- Take care when using a power washer to clean the engine. The high-pressure fluid could penetrate the sealed parts and cause damage.
- Do not spray a hot engine with cold water to avoid cracking the engine block or other engine components.
- Spray Motorcraft® Engine Shampoo and Degreaser on all parts that require cleaning and pressure rinse clean. In Canada, use Motorcraft® Engine Shampoo.
- Never wash or rinse the engine while it is hot or running; water in the running engine may cause internal damage.

CLEANING THE WINDOWS AND WIPER BLADES

The windows and wiper blades should be cleaned regularly. If the wipers do not wipe properly, substances on the vehicle's glass or the wiper blades may cause squeaking or chatter noise from the blades, and streaking and smearing of the windshield. To clean these items, follow these tips:

- The windows may be cleaned with a non-abrasive cleaner, such as Motorcraft® Ultra-Clear Spray Glass Cleaner.
- The wiper blades can be cleaned with isopropyl (rubbing) alcohol or Motorcraft® Premium Windshield Washer Concentrate in the U.S., or Premium Quality Windshield Washer Fluid in Canada. Be sure to replace wiper blades when they appear worn or do not function properly.
- Do not use abrasives, as they may cause scratches.
- Do not use fuel, kerosene, or paint thinner to clean any parts.

If you cannot remove those streaks after cleaning with the glass cleaner or if the wipers chatter and move in a jerky motion, clean the outer surface of the windshield and the wiper blades using a sponge or soft cloth with a neutral detergent or mild-abrasive cleaning solution. After cleaning, rinse the windshield and wiper blades with clean water. The windshield is clean if beads do not form when you rinse the windshield with water.

CLEANING THE INTERIOR



WARNING: Do not use cleaning solvents, bleach or dye on the vehicle's safety belts, as these actions may weaken the belt webbing.



WARNING: On vehicles equipped with seat-mounted airbags, do not use chemical solvents or strong detergents. Such products could contaminate the side airbag system and affect performance of the side airbag in a collision.

For fabric, carpets, cloth seats, safety belts and seats equipped with side airbags:

- Remove dust and loose dirt with a vacuum cleaner.
- Apply a layer of high quality foam cleaner, designed for automotive interiors, to the dry stained area (s) of the item being cleaned and allow to soak for one minute.
- If grease or tar is present on the material, spot-clean the area first with Motorcraft Spot and Stain Remover. In Canada, use Motorcraft Multi-Purpose Cleaner.
- If a ring forms on the fabric after spot cleaning, clean the entire area immediately (but do not oversaturate) or the ring will set.
- Do not use household cleaning products or glass cleaners, which can stain and discolor the fabric and affect the flame retardant abilities of the seat materials.

CLEANING THE INSTRUMENT PANEL AND INSTRUMENT CLUSTER LENS

WARNING: Do not use chemical solvents or strong detergents when cleaning the steering wheel or instrument panel to avoid contamination of the airbag system.

Clean the instrument panel and cluster lens with a clean, damp, white, cotton cloth, then use a clean and dry, white, cotton cloth to dry these areas.

- Avoid cleaners or polishes that increase the gloss of the upper portion of the instrument panel. The dull finish in this area helps protect the driver from undesirable windshield reflection.
- Be certain to wash or wipe your hands clean if you have been in contact with certain products such as insect repellent and suntan lotion in order to avoid possible damage to the interior painted surfaces.
- Do not use household or glass cleaners as these may damage the finish of the instrument panel, interior trim and cluster lens.
- Do not allow air fresheners and hand sanitizers to spill on interior surfaces. If a spill occurs, wipe off immediately. Damage may not be covered by your warranty.

If a staining liquid, like coffee or juice, has been spilled on the instrument panel or on interior trim surfaces, clean as follows:

1. Wipe up spilled liquid using a clean, white, cotton cloth.
2. Wipe the surface with a damp, clean, white, cotton cloth. For more thorough cleaning, use a mild soap and water solution. If the spot cannot be completely cleaned by this method, the area may be cleaned using a commercially available cleaning product designed for automotive interiors.
3. If necessary, apply more soap and water solution or cleaning product to a clean, white, cotton cloth and press the cloth onto the soiled area. Allow this to set at room temperature for 30 minutes.
4. Remove the soaked cloth, and if it is not soiled badly, use this cloth to clean the area by using a rubbing motion for 60 seconds.
5. Following this, wipe area dry with a clean, white, cotton cloth.

CLEANING LEATHER SEATS

- Clean spills and stains as quickly as possible.
- For routine cleaning, wipe the surface with a soft, damp cloth. For more thorough cleaning, wipe the surface with a mild soap and water solution. In Canada, use Motorcraft® Vinyl Cleaner (CXC-93). Dry the area with a soft cloth.
- If the leather cannot be completely cleaned using a mild soap and water solution, the leather may be cleaned using a commercially available leather cleaning product designed for automotive interiors.
- To check for compatibility, first test any cleaner or stain remover on an inconspicuous part of the leather.
- Do not use household cleaning products, alcohol solutions, solvents or cleaners intended for rubber, vinyl and plastics, or oil/petroleum-based leather conditioners. These products may cause premature wearing or damage to the leather.

CLEANING THE ALLOY WHEELS

Note: Do not use chrome cleaner, metal cleaner or polish on wheels and wheel covers.

Aluminum wheels and wheel covers are coated with a clearcoat paint finish. In order to maintain their condition:

- Clean weekly with Motorcraft Wheel and Tire Cleaner. Use a sponge to remove heavy deposits of dirt and brake dust accumulation. Rinse thoroughly with a strong stream of water when you have completed the cleaning process.
- To remove tar and grease, use Motorcraft Bug and Tar Remover.
- Never apply any cleaning chemical to hot or warm wheel rims or covers.
- Some automatic car washes may cause damage to the finish on your wheel rims or covers. Industrial-strength (heavy-duty) cleaners, or cleaning chemicals, in combination with brush agitation to remove brake dust and dirt, could wear away the clearcoat finish over time.
- Do not use hydrofluoric acid-based or high caustic-based wheel cleaners, steel wool, fuels or strong household detergent.
- If you intend parking your vehicle for an extended period after cleaning the wheels with a wheel cleaner, drive your vehicle for a few minutes before doing so. This will reduce the risk of increased corrosion of the brake discs.

VEHICLE STORAGE

If you plan on storing your vehicle for an extended period of time (30 days or more), read the following maintenance recommendations to make sure your vehicle stays in good operating condition.

All motor vehicles and their components were engineered and tested for reliable, regular driving. Long term storage under various conditions may lead to component degradation or failure unless specific precautions are taken to preserve the components.

General

- Store all vehicles in a dry, ventilated place.
- Protect from sunlight, if possible.
- If vehicles are stored outside, they require regular maintenance to protect against rust and damage.

Body

- Wash the vehicle thoroughly to remove dirt, grease, oil, tar or mud from exterior surfaces, rear-wheel housing and the underside of the front fenders.
- Periodically wash vehicles stored in exposed locations.
- Touch-up raw or primed metal to prevent rust.
- Cover chrome and stainless steel parts with a thick coat of auto wax to prevent discoloration. Re-wax as necessary when the vehicle is washed.
- Lubricate all hood and door hinges and latches with a light grade oil.
- Cover interior trim to prevent fading.
- Keep all rubber parts free from oil and solvents.

Engine

- The engine oil and filter should be changed prior to storage. Used engine oil contains contaminants that may cause engine damage.
- Start the engine every 15 days. Run at fast idle until it reaches normal operating temperature.
- With your foot on the brake, shift through all the gears while the engine is running.

Fuel System

Note: During extended periods of vehicle storage (30 days or more), fuel may deteriorate due to oxidation. Add a quality gas stabilizer product to the vehicle fuel system whenever actual or expected storage periods exceed 30 days. Follow the instructions on the additive label. The vehicle should then be operated at idle speed to circulate the additive throughout the fuel system.

- Fill the fuel tank(s) with high-quality fuel until the first automatic shutoff of the fuel pump nozzle.

Cooling System

- Protect against freezing temperatures.
- When removing vehicle from storage, check coolant fluid level. Confirm there are no cooling system leaks, and fluid is at the recommended level.

Battery

Note: If battery cables are disconnected, it is necessary to reset memory features.

- Check and recharge as necessary. Keep connections clean.
- If storing your vehicle for more than 30 days without recharging the battery, it may be advisable to disconnect the battery cables to make sure battery charge is maintained for quick starting.

Brakes

- Make sure brakes and parking brake are fully released.

Tires

- Maintain recommended air pressure.

Miscellaneous

- Make sure all linkages, cables, levers and pins under the vehicle are covered with grease to prevent rust.
- Move vehicles at least 25 feet (8 meters) every 15 days to lubricate working parts and prevent corrosion.

Removing Your Vehicle from Storage

When your vehicle is ready to come out of storage, do the following:

- Wash your vehicle to remove any dirt or grease film build-up on window surfaces.
- Check windshield wipers for any deterioration.
- Check under the hood for any foreign material that may have collected during storage (mice or squirrel nests).
- Check the exhaust for any foreign material that may have collected during storage.
- Check tire pressures and set tire inflation per the Tire Label.
- Check brake pedal operation. Drive the vehicle 15 feet (4.5 meters) back and forth to remove rust build-up.
- Check fluid levels (including engine coolant, engine oil and fuel) to make sure there are no leaks and fluids are at recommended levels.
- If the battery was removed, clean the battery cable ends and inspect.

Contact your authorized dealer if you have any concerns or issues.

TIRES**Tire Inflation Information**

WARNING: Always maintain your tires in good condition.

Frequently check and maintain correct inflation pressures as specified by tire manufacturers. Inspect periodically for abnormal wear patterns and repair/replace cut or broken tire casings. Always use experienced, trained personnel with proper equipment and correct procedures to mount or remove tires and wheels. Failure to adhere to these warnings could result in wheel or tire malfunction, damage to your vehicle, personal injury, or death.



WARNING: To avoid personal injury or death, always follow these instructions when mounting radial tires on wheels:

- Only personnel that have had proper training and experience should mount or remove tires from rims or wheels.
- Use only heavy-duty rims or approved rims for radial tires. It may be necessary to contact your wheel and rim distributor to determine if your rims are approved for radial tires.
- If a tube is to be used, make sure special radial tire tubes are used because of the increased flexing of the sidewalls on radial tires.
- Never use anti-freeze, silicones, or petroleum-based lubricants when mounting radial tires. Only an approved lubricant should be used as an aid for mounting tires.
- Always inflate tires in a safety cage.
- Do not attempt to mix stud piloted wheels or fasteners with hub piloted wheels or fasteners. To do so may cause premature wheel failure resulting in property damage, personal injury, or death.
- Do not mix foreign (not made in North America) wheel mounting parts with domestic (made in North America) parts. Many foreign wheel components look similar to, but not exactly the same as domestic made components. Mixing components could cause wheel or fastener failures and result in property damage, personal injury, or death.

 **WARNING** (Continued)

- Do not change from aluminum wheels to steel wheels or vice-versa without changing the mounting hardware where required or, in some cases with flange nut mounting systems, changing the hub and stud assembly. Mixing components could cause wheel or fastener failures and result in property damage, personal injury, or death.

 **WARNING:** An inflated tire and rim can be very dangerous if improperly used, serviced or maintained. To avoid serious injury, never attempt to re-inflate a tire which has been run flat or seriously under-inflated without first removing the tire from the wheel assembly for inspection. Do not attempt to add air to tires or replace tires or wheels without first taking precautions to protect persons and property.

All tires with Steel Carcass Plies (if equipped): This type of tire utilizes steel cords in the sidewalls. As such, they cannot be treated like normal light truck tires. Tire service, including adjusting the air pressure, must be performed by personnel trained, supervised and equipped according to Federal Occupational Safety and Health Administration (OSHA) regulations. For example, during any procedure involving tire inflation, the technician or individual must utilize a remote inflation device, and make sure that all persons are clear of the trajectory area.

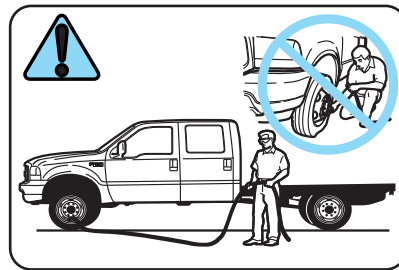

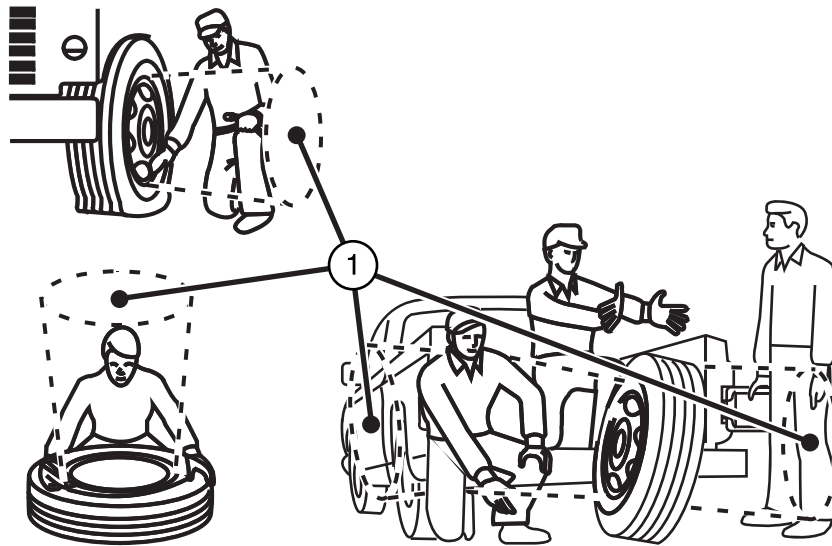

Stay out of the trajectory (1) as indicated in the illustration.



WARNING: Do not mount tube type tires on tubeless wheels or tubeless tires on tube type wheels. To do so could result in tire or wheel failure and cause property damage, personal injury or death.

Preserving proper inflation pressure is a very important maintenance practice to make sure safe vehicle operation and long life for the tires.

Failure to maintain correct inflation pressure may result in sudden tire destruction, improper vehicle handling, and may cause rapid and irregular tire wear. Therefore, inflation pressures should be checked daily and always before long distance trips.

Follow the tire manufacturer's recommended cold inflation pressure for the tire size, type, load range (ply rating) and axle loading typical for your operation. (Each steer axle tire load equals $\frac{1}{2}$ steer axle loading; each drive tire load is $\frac{1}{4}$ the axle loading if fitted with four tires).

Checking Tire Pressure

Always check inflation pressure when tires are cold. Never bleed air from hot tires to relieve normal pressure build-up. Normal increase in pressure due to service conditions is 10–15 psi (69–103 kPa), which is allowable in truck tires.

Tires should be properly inflated to manufacturers' recommended pressure for the size and service load in which the vehicle is being used. See the specific tire manufacturer with which your vehicle is equipped with for the latest information concerning service load and inflation pressure.

It is particularly important to keep moisture from the inside of tires, and proper selection of air compressor equipment, proper air line routing, and the use of shop air dryers is strongly recommended to avoid moisture in the high pressure air used for tire inflation.

Under-inflation

Tires should not be permitted to become under-inflated. Increased flexing due to under-inflation causes heat build-up within the tire components. This leads to reduced strength, breakdown of the rubber compounds, and possible separation of the tire components (i.e., ply and tread separation and reduced retreadability).

Under-inflation is the primary cause of premature tire concerns including sudden loss of air. In addition, low inflation causes an increase in rolling resistance. This results in reduced fuel mileage, a loss in tread mileage, and uneven wear due to increased tread movement. To determine proper inflation, see the tire manufacturer load and inflation guide which can be found on the tire manufacturer website or at your local truck tire dealer.

Tire Inspection

Check the tires for abnormal wear patterns and proper inflation pressures. Cut or broken tire casings must be repaired or replaced.

Tires should also be inspected for the following conditions. If any are present, the tire should be removed and repaired, retreaded or scrapped as the condition indicates.

- Any blister, bump or raised portion anywhere on the surface of the tire tread or sidewall (other than a bump made by a repair). These indicate the start of internal separation.
- Any cut that reaches to the belt or ply cords, or any cut that is large enough to grow in size and depth.
- Any nail or puncturing object.
- If any stone or object is held by a tread groove and is starting to drill into the tread base, remove the object.

Proper tire inflation, toe-in adjustment, loads, and road speeds are important factors governing tire mileage, steering ease and maneuverability.

Tire Loading



WARNING: Loading tires beyond their rated capacity decreases tire life requiring more frequent replacement of tires. Overloading creates an unsafe condition that may result in sudden air loss from a tire failure resulting in an accident that could cause property damage, personal injury or death.

Note: Your GAW/GVW rating is correct at the time of your vehicle production, and reflects the exact rating of the tires specified. When replacing tires, make sure that the replacement tire load rating (listed in pounds and kilograms on the tire sidewall) is the same or higher than the tire that is removed. Failure to do so adversely affects maximum load carrying capacity. Tires with the same size specification do not always have the same load specification.

Matching Tires

Dual Tires: Dual tires should be matched using tires of equivalent size. Tires which differ more than $\frac{1}{4}$ inch (6 millimeters) in diameter or $\frac{3}{4}$ inch (19 millimeters) in circumference should not be mounted on the same dual wheel assembly.

Mixing: Never mix bias and radial tires on this vehicle. Never mix different tire sizes or constructions on the same axle.

Rotation:

Rotation is always advisable:

- If front (steering) axle tires become irregularly worn, move to rear position.
- In a dual assembly, reverse the position of the tires if one tire wears much faster than its mate.
- On the drive axle, if heel and toe wear or alternate lug wear occurs, rotating the tires from one end of the axle to the other end of the axle may help even out this wear.

Rotation may not be advisable:

- **Front (Steering) Axle:** Tires must be removed when tread is worn to $\frac{4}{32}$ inch (3 millimeters) or less. Retread or rotate worn tires to drive position. Retreaded tires are not recommended to be used on steering axles.
- **Rear Axles:** Tires must be removed when tread is worn to $\frac{2}{32}$ inch (2 millimeters).

If rib tire is used on front axle and lug or off-road type on rear axle positions:

- **Front (Steering) Axle:** Replace tires at front wheels when tread is worn to $4/32$ inch (3 millimeters) or less.
- **Rear Axles:** Tires must be removed when the tread is worn to $2/32$ inch (2 millimeters) or less. Tires identified with the word re-groovable molded on the sidewall can be re-grooved. A minimum of $3/32$ inch (2.5 millimeters) of under-tread must be left at the bottom of the grooves.

Wheel and Tire Balancing

Out-of-round or out-of-balance wheels or tires can cause vehicle vibration, bounce and shimmy. Replace damaged or out-of-round wheels. Out-of-round tires and wheel assemblies can be corrected by re-clocking the tire relative to the wheel.

The tire and wheel assembly should then be dynamically balanced.

Tire Wear

Radial tires can exhibit three types of normal wear patterns:

- Even
- Erosion
- Chamfer

Even wear: A sign that the tire is being properly used and maintained.

Erosion wear: Also called rolling wear, channel or river wear. Erosion wear is found more often on free-rolling tires. This is an indication that the tire is being used in a slow wearing operation. What happens is that the belt plies are held very rigid and the tread is not allowed to distort as it passes through the contact area. Wear only occurs at the edge of the tread. No corrective action required. If erosion gets to be $1/16$ inch (2 millimeters) or more, the tire may be rotated to a drive axle.

Chamfer or shoulder wear: With tires inflated properly, this is a normal tendency of most radial tire designs. If both inside and outside shoulders are wearing evenly around the tire, no further action is required. Over-inflation is not effective in correcting this effect.

Irregular Wear: If irregular wear is present, check the axle alignment, tire pressure, wheel balancing, shock and suspension component condition, and wheel bearing end play.

This condition not only shortens tire life, but adversely affects the handling of your vehicle, which is dangerous.

Rotating tires from one wheel position to another is a way often used to even out many types of irregular wear or to avoid it altogether. Some of the more effective tire rotation programs are:

- Steer tires that have developed some type of irregular wear pattern can be rotated to drive axles if rib tires are being used on all wheel positions. Applying steer tires to a drive position often cleans them and they can be moved back to the steer axles or run out to re-tread stage on the rear axle.
- Another rotation possibility for fleets with rib tires in all wheel positions is to break in the new steer tires in the drive axle positions, then move them to steer axles. This wears away tread rubber relatively quickly in the early life of a tire when it is most likely to develop an unusual wear pattern.
- Drive axle tires may be placed on the other end of the same axle so that direction of rotation is reversed. This is often helpful if a heel and toe or alternate lug wear pattern has developed.

Irregular wear can be minimized by:

- Using the right inflation pressure for the load being carried.
- Maintaining proper front wheel alignment, especially toe-in, to specifications.
- Maintaining proper tire and wheel balance.
- Maintaining shock absorbers and suspension components.

Use of Tire Chains

See the chain manufacturer's recommendation for correct tire chain usage, installation and removal.

WHEELS

General Information

Note: Remember to replace the wheel air valves when the road tires are replaced at the end of their useful lives.

Wheel bearings should be inspected, lubricated and adjusted at regular intervals. This is especially important if operating in deep sand, mud or water. See the *Capacities and Specifications* chapter.

Mount wheel balance weights on the dome-side of the wheel only. Failure to do so may result in loss of wheel weight or damage to brakes or wheels.

Oil-lubricated Front Wheel Bearings

During normal vehicle duty cycle, the lubricant and air inside the hub/wheel cavity expands and, if not vented, causes pressure build-up that could cause accelerated seal wear. There are two venting methods that can be used to prevent pressure build-up:

- a slit or small hole in the rubber check vent
- the window.

Over a period of time, if not routinely cleaned, a slight film of oil can collect dirt around the rubber fill plug and face, which could appear to be a leak. Routine cleaning makes sure that the lubricant level can be easily observed through the window as intended. In situations where the window is clean on the outside but discolored on the inside, the lubricant level may be checked by inserting a finger through the rubber check vent hole.

The specified lubricant level for a window-type hubcap is from the minimum line to 5/16 inch (8 millimeters) above the minimum line. If the lubricant level should suddenly drop dramatically below the minimum level, see the *Workshop Manual* for diagnostic procedure.

Installation, Tightening and Alignment

Make sure the threads on the studs and nuts are clean to permit correct torque when installing wheels. The mounting surfaces of rims, wheels, spacer rings and clamps must be free of dirt, rust, lubricants or damage. Use a wire brush to clean the mounting contact surfaces. Do not use lubricant on threads.

Check the rim or wheel for proper alignment after it has been properly tightened. Rotate the wheel with a piece of chalk attached to a steady, firm surface, and placed to just barely clear the outside surface of the tire bead seat; this procedure points out the high spot. A high spot does not necessarily mean that the lug nuts have been unevenly tightened, but could be the result of a bent wheel.

Use the following installation procedure:

1. Slide inner rear or front tire and wheel in position over studs and push it back as far as possible. Use care so that the threads on the studs are not damaged.

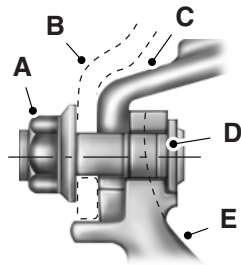
Disc Wheel with Flange Nuts (Hub-piloted).

Front wheel mounting of flange nut system.

- A. Flange nut
- B. Wheel(s)
- C. Brake drum
- D. Wheel stud (22 millimeter)
- E. Wheel hub

2. Position the outer rear tire and wheel in place over the studs and push it back as far as possible. Use care so that the threads on the studs are not damaged.

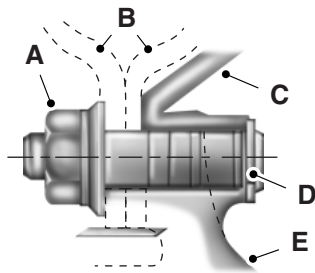

Rear wheel mounting of flange nut system.

- A. Flange nut
- B. Wheel(s)
- C. Brake drum
- D. Wheel stud (22 millimeter)
- E. Wheel hub

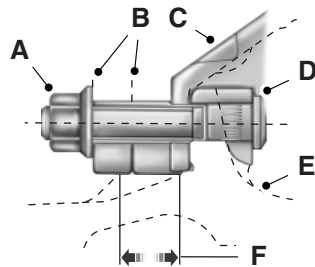
Aluminum Rear Disc Wheel with Flange Nuts (Hub-piloted).

- A. Flange nut
- B. Wheel(s)
- C. Brake drum
- D. Wheel stud (22 millimeter)
- E. Wheel hub
- F. Wheel locator pad

Note for aluminum wheels: Clean each wheel locator pad on the hub from all dirt, rust and foreign material prior to re-installing rear aluminum hub-piloted wheels. Apply a light coat of chassis grease, never-seize or disc brake corrosion control grease, only to the wheel locator pad.

3. Run the nuts on the studs until they contact the wheel(s). Rotate the wheel assembly a half-turn to permit the parts to seat.

4. Draw-up the nuts alternately following the crisscross sequence illustrated under the following wheel tightening sequence illustrations. Do not fully tighten the nuts. This allows uniform seating of the nuts and makes sure even face-to-face contact of the wheel and hub.

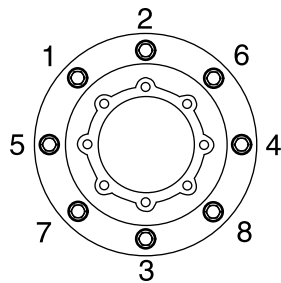

8-lug wheel

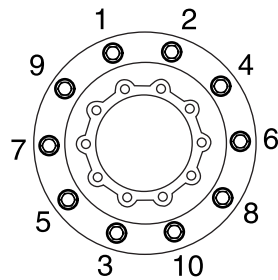

10-lug wheel

5. Continue tightening the nuts to the torque specifications in the torque chart using the same crisscross sequence shown.

6. After operating the vehicle approximately 50 miles (80 kilometers), check the nuts for tightness. Some natural seating of parts may be encountered and the torque on the nuts can drop. Retighten all nuts to specifications.

Once a week, inspect and retighten the wheel stud nuts.

Note: Make sure the tire valve stem clears the brake caliper when installing the tire and rim assembly on disc-brake equipped axles. The use of a tire manufacturer's stem forming tool is the only acceptable method of obtaining clearance when necessary.

Proper Torque

It is important to tighten and maintain wheel and rim mounting nuts to the proper torque. Loose nuts or over-tightened nuts can lead to premature wear and possible failure of the wheel or mounting hardware.

Changing Wheel Types



WARNING: Use only the same type and style wheels and mounting hardware to replace original parts. Failure to do so may result in an assembly that looks fine, but does not fit together properly. This could possibly cause wheel or fastener failures which could result in property damage, personal injury or death.

Note: Do not attempt to mix stud-piloted wheels or fasteners with hub-piloted wheels or fasteners.

Note: Do not change from aluminum wheels to steel wheels or vice-versa without changing the mounting hardware required or, with flange nut mounting systems, changing the hub and stud assembly.

Consult your dealer or wheel or rim distributor before attempting any wheel or fastener changes.

TECHNICAL SPECIFICATIONS

Wheel Lug Nut Torque Specifications

Note: Do not use lubrication on dry threads. Where excessive corrosion exists, a light coat of lubricant on the first three threads of the stud bolt is permitted. Keep lubricant away from:

- Hex nut and rim clamp contact surfaces.
- Cap nut ball face and ball seat on the disc wheel.
- Flange nut washer surface and flat on the disc wheel.

Size	Nut Mounting	Torque	
		ft-lb	N•m
22 mm	Flange	450-500	610-678

ENGINE SPECIFICATIONS (GASOLINE ENGINE ONLY)

Engine	6.8L V10 engine
Cubic inches	413
Required fuel	Minimum 87 octane
Firing order	1-6-5-10-2-7-3-8-4-9
Spark plug gap	0.039–0.043 inch (1.0–1.1 mm)
Ignition system	Coil on plug
Compression ratio	9.2:1

Engine Drivebelt Routing

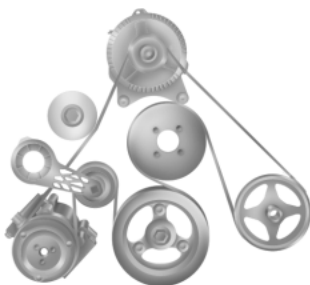

6.8L V10 engine with A/C

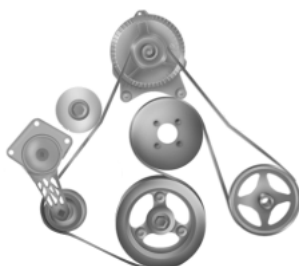

6.8L V10 engine - without A/C

TECHNICAL SPECIFICATIONS

Component	Lubrication Type	Viscosity / Ambient Temperature / Notes	Equivalent Ford Part Name / Number
Eaton-Spicer axle (generic) - front axle wheel bearing oil	Multipurpose EP gear lube of API GL-5 quality meeting MIL-PRF-2105E specifications including synthetic lubricants. Do not mix conventional and synthetic lubricants.	Non-driving front axle	
		SAE 75W: -40°F to -15°F (-40°C to -26°C)	Motorcraft® SAE 75W-140 Synthetic Rear Axle Lubricant / XY-75W140-QL
		SAE 75W-80: -40°F to 80°F (-40°C to 27°C)	
		SAE 75W-140: -40°F and above (-40°C and above)	
		SAE 80W-140: -15°F and above (-26°C and above)	
		SAE 85W-140: 10°F and above (-12°C and above)	
		SAE 80W-90: -15°F to 100°F (-26°C to 38°C)	Motorcraft® SAE 80W-90 Premium Rear Axle Lubricant / XY-80W90-QL

Component	Lubrication Type	Viscosity / Ambient Temperature / Notes	Equivalent Ford Part Name / Number
Spicer axle - front axle wheel bearing oil	Multipurpose EP gear lube of API GL-5 quality meeting MIL-PRF-2105E specifications including synthetic lubricants. Do not mix conventional and synthetic lubricants.	SAE 75W: -40°F to 32°F (-40°C to 0°C)	Motorcraft® SAE 75W-140 Synthetic Rear Axle Lubricant / XY-75W140-QL
		SAE 75W-140: -40°F and above (-40°C and above)	
		SAE 80W-140: -15°F and above (-26°C and above)	Motorcraft® SAE 80W-90 Premium Rear Axle Lubricant / XY-80W90-QL
		SAE 85W-140: 10°F and above (-12°C and above)	
		SAE 140W: 40°F and above (4°C and above)	
		SAE 80W: -15°F to 70°F (-26°C to 21°C)	
SAE 90W: 10°F to 100°F (-12°C to 38°C)			

Component	Lubrication Type	Viscosity / Ambient Temperature / Notes	Equivalent Ford Part Name / Number
Eaton-Spicer axle, Spicer axle - Front axle wheel bearing grease, tie rod ends, drag link, kingpin and bushing	EP2 Lithium complex-based moly grease (or equivalent) GC/LB NLGI #2 multi-purpose lithium complex grease	Note: Eaton-Spicer and Meritor Easy Steer axles: With chassis load on axle, force grease through thrust bearings; then with axle lifted clear of the floor, force grease between kingpin and bushing surfaces.	Motorcraft® Premium Long Life Grease / XG-1-C
Steering			
Power steering fluid	MERCON® V ATF	—	MERCON® V / XT-5-QMC; XT-5-QM; XL-14
Steering gear Ross TAS - Output Seal, Steering column U-joints / slip joint	GC/LB NLGI #2 lithium complex-based moly grease or multi-purpose lithium complex grease	—	Motorcraft® Premium Long Life Grease / XG-1-C

Component	Lubrication Type	Viscosity / Ambient Temperature / Notes	Equivalent Ford Part Name / Number
Driveshaft			
U-joint	GC/LB NLGI #2 lithium complex-based moly grease or multi-purpose lithium complex grease	—	Motorcraft® Premium Long Life Grease / XG-1-C
Clutch			
Release bearing / shafts / fork	GC/LB NLGI #2 lithium complex-based moly grease or multi-purpose lithium complex grease	—	Motorcraft® Premium Long Life Grease / XG-1-C
Reservoir	DOT 3, WSS-M6C62-A or WSS-M6C65-A1	—	High Performance DOT 3 Motor Vehicle Brake Fluid, PM-1-C (U.S.) or CPM-1-C (Canada)
Cooling System			
Engine coolant	WSS-M97B44-D2	—	Motorcraft® Orange Antifreeze/Coolant Prediluted/ VC-3DIL-B (U.S.) CVC-3DIL-B (Canada)

Component	Lubrication Type	Viscosity / Ambient Temperature / Notes	Equivalent Ford Part Name / Number
Washer fluid	WSB-M8B16-A2	—	Motorcraft® Premium Windshield Washer Concentrate / ZC-32-A (U.S.) or CXC-37-(A, B, D, and F) (Canada)
Windshield Washer			
Transmission			
Six-speed automatic (6R140)	—	—	Motorcraft® MERCON® LV ATF / XT-10-QLV
Eaton-Fuller	Petroleum oil: Engine oil API-SL or API-CF (MIL-L-2104E or MIL-L-46152E)	SAE 40W: Below 10°F (-12°C)	—
		SAE 50W: Above 10°F (-12°C)	—
	Mineral gear oil: API-GL-1 (rust and oxidation inhibited)	SAE 75W: Below 10°F (-12°C)	—
		SAE 80W-90: Above 10°F (-12°C)	—
		CD SAE 50W: All temperatures	—
Synthetic oil: Eaton®, Roadranger® synthetic CD-50 transmission fluid			

Component	Lubrication Type	Viscosity / Ambient Temperature / Notes	Equivalent Ford Part Name / Number
Spicer (non-synchronized) (Lubricants are listed in order of preference.)	Petroleum oil: Engine oil API-SL or API-CF (MIL-L-2104E or MIL-L-46152E)	SAE 40W: Below 0°F (-18°C)	—
		SAE 50W: Above 0°F (-18°C)	—
	Mineral gear oil: API-GL-1 (rust and oxidation inhibited)	SAE 80W: Below 0°F (-18°C)	—
	(EP gear oils are not acceptable.)	SAE 90W: Above 0°F (-18°C)	—
	Synthetic oil: Synthetic engine oil meeting MIL-L-2104E or MIL-L-46152E, API-SL or API-CF	CD SAE 50W: All temperatures	—

Component	Lubrication Type	Viscosity / Ambient Temperature / Notes	Equivalent Ford Part Name / Number
Spicer (synchronized) (Lubricants are listed in order of preference.)	Petroleum oil: Engine oil API-SL or API-CF (MIL-L-2104E or MIL-L-46152E)	SAE 40W: Below 10°F (-12°C)	—
		SAE 50W: Above 10°F (-12°C)	—
	Mineral gear oil: API-GL-1 (rust and oxidation inhibited)	SAE 80W: Below 10°F (-12°C)	—
		SAE 90W: Above 10°F (-12°C)	—
	Synthetic oil: Synthetic engine oil meeting MIL-L-2104E or MIL-L-46152E, API-SL or API-CF	SAE 50W: All temperatures	—

Component	Lubrication Type	Viscosity / Ambient Temperature / Notes	Equivalent Ford Part Name / Number
Meritor	Petroleum oil: Heavy Duty Engine Oil MIL-L-2104E or API-SL or API-CF (previous API designations acceptable) Mineral gear oil with rust and oxidation inhibitor API-GL-1. Do not use multi-weight and GL-5 EP gear oils; they may cause transmission failure or damage. Synthetic oil: MIL-L-2104E or MIL-L-46152D. Do not use multi-weight and GL-5 EP gear oils; they may cause transmission failure or damage.	SAE 30W: Below 10°F (-12°C) SAE 40W or SAE 50W: Above 10°F (-12°C) SAE 80W: Below 10°F (-12°C) SAE 90W: Above 10°F (-12°C) SAE 50W: All temperatures	Motorcraft® SAE 30 Super Duty Motor Oil / XO-30-QSD — — — —
Allison	See transmission operator's manual		

Component	Lubrication Type	Viscosity / Ambient Temperature / Notes	Equivalent Ford Part Name / Number
Rear Axle			
Eaton-Spicer - two-speed axle	RHEOLUBE 362 (or equivalent) (Eaton part number 113741)	—	—
Eaton - single-speed axle	Generic lubricant	SAE 75W: -40°F to -15°F (-40°C to -26°C)	Motorcraft® SAE 75W-140 Synthetic Rear Axle Lubricant / XY-75W140-QL
		SAE 75W-80: -40°F to 80°F (-40°C to 27°C)	
		SAE 75W-140: -40°F and above (-40°C and above)	
		SAE 80W-140: -15°F and above (-26°C and above)	
		SAE 85W-140: 10°F and above (-12°C and above)	
		SAE 80W-90: -15°F to 100°F (-26°C to 38°C)	Motorcraft® SAE 80W-90 Premium Rear Axle Lubricant / XY-80W90-QL

Component	Lubrication Type	Viscosity / Ambient Temperature / Notes	Equivalent Ford Part Name / Number
Spicer - single-speed axle	Multipurpose EP gear lube of API GL-5 quality meeting MIL-PRF-2105E specifications including synthetic lubricants	SAE 75W: -40°F to 32°F (-40°C to 0°C)	Motorcraft® SAE 75W-140 Synthetic Rear Axle Lubricant / XY-75W140-QL
		SAE 75W-140: -40°F and above (-40°C and above)	
		SAE 80W: -15°F to 70°F (-26°C to 21°C)	
		SAE 80W-140: -15°F and above (-26°C and above)	
		SAE 85W-140: 10°F and above (-12°C and above)	
		SAE 140W: 40°F and above (4°C and above)	
		SAE 90W: 10°F to 100°F (-12°C to 38°C)	
			Motorcraft® SAE 80W-90 Premium Rear Axle Lubricant / XY-80W90-QL

Component	Lubrication Type	Viscosity / Ambient Temperature / Notes	Equivalent Ford Part Name / Number
Meritor (non-extended drain lubricants)	Petroleum with EP additives of API GL-5 quality meeting MIL-PRF-2105E specifications	SAE 75W: Above -40°F (-40°C); Up to 35°F (2°C)	Motorcraft® SAE 75W-140 Synthetic Rear Axle Lubricant / XY-75W140-QL
		SAE 75W-90: Above -40°F (-40°C)	
		SAE 75W-140: Above -40°F (-40°C)	
		SAE 80W-140: Above -15°F (-26°C)	
		SAE 85W-140: Above 10° (-12°C)	
		SAE 80W-90: Above -15°F (-26°C)	

Component	Lubrication Type	Viscosity / Ambient Temperature / Notes	Equivalent Ford Part Name / Number
Meritor (extended drain lubricants)	Petroleum with extended drain additives of API GL-5 quality meeting MIL-PRF-2105E specifications including synthetic lubricants	SAE 75W-90: Above -40°F (-40°C) (full synthetic)	Motorcraft® SAE 75W-140 Synthetic Rear Axle Lubricant / XY-75W140-QL
		SAE 75W-140: Above -40°F (-40°C) (full synthetic)	
		SAE 80W-90: Above -15°F (-26°C) (semi-synthetic)	Motorcraft® SAE 80W-90 Premium Rear Axle Lubricant / XY-80W90-QL
SAE 80W-90: Above -15°F (-26°C)			
Cab Components			
Door check, hinges, latches and strikers; Seat adjuster slides	GC/LB NLGI #2 lithium complex-based moly grease (or equivalent) or multi-purpose lithium complex grease	—	Motorcraft® Premium Long Life Grease / XG-1-C
		—	Motorcraft® Penetrating and Lock Lubricant / XL-1
Door lock cylinders	Lock oil	—	Motorcraft® Multi-Purpose Grease Spray / XL-5 or CRC® SL3151 (or equivalent)
Door window regulators	NGLI #2 multipurpose lithium complex grease	—	

Component	Lubrication Type	Viscosity / Ambient Temperature / Notes	Equivalent Ford Part Name / Number
Weatherstripping	Silicone lubricant	—	Motorcraft® Silicone Spray / XL-6
Engine Oil			
Diesel engine: See engine operator's manual.			
Gasoline engine:	<ul style="list-style-type: none"> • Motorcraft® SAE 5W-20 Premium Synthetic Blend Motor Oil (U.S.) • Motorcraft® SAE 5W-20 Full Synthetic Motor Oil (U.S.) • Motorcraft® SAE 5W-20 Super Premium Motor Oil (Canada) • Motorcraft® SAE 5W-20 Synthetic Motor Oil (Canada) / WSS-M2C945-A and API Certification Mark 	—	<ul style="list-style-type: none"> • XO-5W20-QSP (U.S.) • XO-5W20-QFS (U.S.) • CXO-5W20-LSP12 (Canada) • CXO-5W-20-LFS12 (Canada)
Brake Fluid			
Master cylinder	DOT 3, WSS-M6C62-A or WSS-M6C65-A1	—	High Performance DOT 3 Motor Vehicle Brake Fluid, PM-1-C (U.S.) or CPM-1-C (Canada)

REFILL CAPACITIES

Engine Coolant and Engine Oil

Engine	Engine Coolant*	Engine Oil*
Diesel	26.0 quarts (24.6L)**	Refer to engine operator's manual.
Gasoline	26.3 quarts (24.9L)**	7.0 quarts (6.6L) (includes filter change)

*Quantities listed are approximate.

**Add the coolant type originally equipped in your vehicle.

Transmission

Note: Capacities may be increased if the vehicle is equipped with a cooler. Always check to make sure the fluid level is in the acceptable range.

Description	Capacity - Pints (Liters)
Allison 2000 Series	30.0 (14.2)*
Allison 3000 Series	37.6 (17.8)*
TorqShift® six-speed	31.0 (14.9)
5-speed manual	12.5 (5.9)
6-speed manual	19.5 (9.2)
7-speed manual	22.0 (10.4)

*Total fluid capacity (dry transmission and torque converter).

Rear Axle

Eaton-Spicer			
Axle Code	Weight Capacity - lb (kg)	Description	Capacity - Pints (Liters)*
S135-S	13500 (6123)	Single reduction	24.5 (11.6)
4S150-S	15500 (7031)	Single reduction	24.5 (11.6)
17060S	17500 (7938)	Single reduction	28.0 (13.2)
19055T	17500 (7938)	Two-speed	28.0 (13.2)
19060S	19000 (8618)	Single reduction	28.0 (13.2)
M190T	19000 (8618)	Two-speed	35.0 (17.0)

Eaton-Spicer			
Axle Code	Weight Capacity - lb (kg)	Description	Capacity - Pints (Liters)*
21060S	21000 (9525)	Single reduction	28.0 (13.2)
21060D	21000 (9525)	Single reduction, driver-controlled locking differential	28.0 (13.2)
M210T	21000 (9525)	Two-speed	16.0 (33.0)
23090S	23000 (10432)	Single reduction	39.0 (18.5)
23090D	23000 (10432)	Single reduction, driver-controlled locking differential	39.0 (18.5)
23082T	23000 (10432)	Two-speed	37.0 (17.5)

*Quantities listed are approximate. Fill axle until the lubricant level is at the bottom of the filler hole, with the vehicle on level ground. If hubs are removed, add an additional 1.6 pints (0.75 liters) of axle lubricant. Add lubricant through the axle vent.

Meritor	
Axle Model	Capacity - Pints (Liters)*
RS-17-140	28.6 (13.5)
RS-17-144	32.0 (15.0)
RS-17-145	33.6 (15.9)
RS-17-220	30.7 (14.5)
RS-17-224	29.0 (13.0)
RS-19-144	32.0 (15.0)
RS-19-145	33.2 (15.7)
RS-19-220	30.0 (14.0)
RS-19-223	29.0 (13.0)
RS-21-145	32.3 (15.3)
RS-21-160	39.0 (18.0)
RS-21-230	38.9 (18.4)
RS-23-160	39.5 (18.7)
RS-23-161	37.2 (17.6)

Meritor	
Axle Model	Capacity - Pints (Liters)*
RS-23-180/186	47.3 (22.4)
RS-23-240	37.4 (17.7)
RS-23-380	63.6 (30.1)

*Oil capacities are for standard track axles that have been measured at various common drive pinion angles. The quantities listed include enough oil for both wheel ends. These capacities change if the track or the drive pinion angle is different.

Power Steering

Note: Capacities may be increased if the vehicle is equipped with a cooler. Always check to make sure the fluid level is in the acceptable range.

Steering Gear	Capacity - Pints (Liters)
TAS40	17.6 (8.3)
TAS66	18.4 (8.7)

Air Conditioner Refrigerant

Note: This system uses mineral-based refrigerant oil to lubricate o-rings and fittings.

This system uses r134a refrigerant and PAG-type refrigerant oil.

Torque the captured washer nut to 170–190 inch-pounds (19–21 Newton-meters) after servicing.

Fuel Tanks

Standard tanks are listed as such. All other tanks available for your vehicle are optional equipment.

Gasoline engine	
Tank Type	Capacity - Gallons (Liters)
Single, steel rectangular	42 (159)
	60 (227)

Diesel engine	
Tank Type	Capacity - Gallons (Liters)
Single, steel rectangular	35 (132)
Single, steel rectangular	45 (170)
Single, steel rectangular	65 (246)
Single, steel D-style	65 (246)
Single, steel D-style	80 (303)
Dual, steel rectangular	35 (RH)/45 (LH) (132 [RH]/170 [LH])
Dual, steel rectangular	45/45 (170/170)
Dual, steel D-style	50/50 (189/189)
Dual, steel D-style	65 (RH)/45 (LH) (246 [RH]/170 [LH])
Dual, steel rectangular	65/65 (246/246)
Dual, steel D-style	80/65 (303/246)

MOTORCRAFT® PART NUMBERS

Component	6.8L V10 Engine
Air filter element	FA-1889
Oil filter	FL-820-S
Battery (standard)	BXT-65-650
Battery (optional)	BXT-65-750
Spark plugs-platinum	—

*For spark plug replacement, see your authorized dealer. See the *Scheduled Maintenance* chapter for the appropriate intervals for changing the spark plugs.

Note: Replace the spark plugs with ones that meet Ford material and design specifications for your vehicle, such as Motorcraft® or equivalent replacement parts. The customer warranty may be void for any damage to the engine if such spark plugs are not used.

VEHICLE IDENTIFICATION NUMBER

The VIN is printed on the Vehicle Rating Decal attached to the vehicle on the edge of the driver's door or B-Pillar. The VIN also serves as the warranty number. If you ever find it necessary to communicate with Ford Motor Company about your vehicle, always include the VIN in your communication.

VEHICLE CERTIFICATION LABEL

A product of FORD MOTOR COMPANY							
Incomplete Vehicle Manufactured By (Vehicule incomplet fabrique par)							
BLUE DIAMOND TRUCK, S. de R.L. de C.V.							
G P		G P	FRONT	G P	REAR		
V N	(33000 LB)	A N	(12000 LB)	A N	(21000 LB)		
W B	14969 KG	W B	5443 KG	W B	9525 KG		
R V		R E		R E			
A SUITABLE TIRE		11RX22.5-14 TIRES		11RX22.5-14 TIRES			
AND RIM CHOICE:		22.5X8.25 RIMS		22.5X8.25 RIMS			
WB: 194.0 IN		AT 724 KPA/105 PSI COLD		AT 724 KPA/105 PSI COLD DUAL		ASSEMBLED IN MEXICO	
493.0 CM		Model: F750 4X2					
VIN 3FRXF75L0V285893				MFD ON AUG-24-2006			
Ext. Pnt: XX		Int. Trim: XX		Axle: XX		Tran: X	

The National Highway Traffic Safety Administration Regulations require that a Safety Compliance Certification Label be affixed to a vehicle and prescribe where the Safety Compliance Certification Label may be located. The Safety Compliance Certification Label shall be affixed to either the door hinge pillar, the door latch post, or the edge of the door near the door latch, next to the driver's seating position.

TRANSMISSION CODE DESIGNATION

A product of FORD MOTOR COMPANY					
Incomplete Vehicle Manufactured By (Vehicule incomplet fabrique par)					
BLUE DIAMOND TRUCK, S. de R.L. de C.V.					
G P	G P	FRONT		G P	REAR
V N (33000 LB)	A N (12000 LB)			A N (21000 LB)	
W B 14969 KG	W B 5443 KG			W B 9525 KG	
R V	R E			R E	
A SUITABLE TIRE		11RX22.5-14 TIRES	11RX22.5-14 TIRES		
AND RIM CHOICE:		22.5X8.25 RIMS	22.5X8.25 RIMS		
WB: 194.0 IN 493.0 CM		AT 724 KPA/105 PSI COLD	AT 724 KPA/105 PSI COLD DUAL		ASSEMBLED IN MEXICO
		Model: F750 4X2			
VIN 3FRXF75L0V285893			MFD ON AUG-24-2006		
					
Ext. Pnt: XX		Int. Trim: XX		Axle: XX Tran: X	

You can find a transmission code on the Safety Compliance Certification Label. The following table tells you which transmission each code represents.

Description	Code
Six-speed TorqShift® automatic (6R140)	P

GENERAL MAINTENANCE INFORMATION**Why Maintain Your Vehicle?**

Carefully following the maintenance schedule helps protect against major repair expenses resulting from neglect or inadequate maintenance and may help to increase the value of your vehicle when you sell or trade it. Keep all receipts for completed maintenance with your vehicle.

We have established regular maintenance intervals for your vehicle based upon rigorous testing. It is important that you have your vehicle serviced at the proper times. These intervals serve two purposes; one is to maintain the reliability of your vehicle and the second is to keep your cost of owning your vehicle down.

It is your responsibility to have all scheduled maintenance performed and to make sure that the materials used meet the specifications identified in the *Capacities and Specifications* chapter of this owner's manual.

Failure to perform scheduled maintenance invalidates warranty coverage on parts affected by the lack of maintenance.

Protecting Your Investment

Maintenance is an investment that pays dividends in the form of improved reliability, durability and resale value. To maintain the proper performance of your vehicle and its emission control systems, make sure you have scheduled maintenance performed at the designated intervals.

Your vehicle is very sophisticated and built with multiple, complex, performance systems. Every manufacturer develops these systems using different specifications and performance features. That is why it is important to rely upon your dealership to properly diagnose and repair your vehicle.

Ford Motor Company has recommended maintenance intervals for various parts and component systems based upon engineering testing. Ford Motor Company relies upon this testing to determine the most appropriate mileage for replacement of oils and fluids to protect your vehicle at the lowest overall cost to you and recommends against maintenance schedules that deviate from the scheduled maintenance information.

We strongly recommend the use of only genuine Ford, Motorcraft or Ford-authorized re-manufactured replacement parts engineered for your vehicle.

Additives and Chemicals

This owner's manual and the Ford Workshop Manual list the recommended additives and chemicals for your vehicle. We do not recommend using chemicals or additives not approved by us as part of your vehicle's normal maintenance. Please consult your warranty information.

Oils, Fluids and Flushing

In many cases, fluid discoloration is a normal operating characteristic and, by itself, does not necessarily indicate a concern or that the fluid needs to be changed. However, a qualified expert, such as the factory-trained technicians at your dealership, should inspect discolored fluids that also show signs of overheating or foreign material contamination immediately.

Make sure to change your vehicle's oils and fluids at the specified intervals or in conjunction with a repair. Flushing is a viable way to change fluid for many vehicle sub-systems during scheduled maintenance. It is critical that systems are flushed only with new fluid that is the same as that required to fill and operate the system or using a Ford-approved flushing chemical.

Owner Checks and Services

Certain basic maintenance checks and inspections should be performed monthly or at six month intervals.

Daily Owner Checks	
Engine	Air filter restriction gauge.
	Engine oil level.
	Engine coolant level.
Brake System	Air brake reservoir automatic drain valve operation.
	Drain the air brake reservoir (manual valve).
Transmission	Visually check for fluid leakage.
Steering System	Power steering fluid level.
	System for evidence of fluid leaks.

Daily Owner Checks	
U.S. Department of Transportation, Federal Highway Administration Requirements (Make sure the entire system is functioning properly.)	Service brakes and parking brake.
	Steering mechanism.
	Lighting devices and reflectors.
	Tires.
	Horn.
	Windshield wipers.
	Rear vision mirrors.
	Wheels and rims.
Emergency equipment.	
Every Oil Change	
Engine	Inspect engine cooling system hoses, clamps and protection.*
	Inspect drive belt(s).
Exhaust System	Inspect entire exhaust system (including the inlet pipe(s), muffler(s), outlet pipe(s), clamps and fasteners) for holes, leakage, breakage, corrosive damage and separation from other components. Adjust, service or replace with the same or the equivalent part. (Also a noise emission control service.)
Suspension	Tighten the front and rear spring U-bolts to the specified torque.
Driveline and Rear Axle	Lubricate the U-joints and the slip yoke.
Brakes	Lubricate the air brake foot control valve, hinge and roller.
	Inspect the drum brake linings through the inspection holes.
	Lubricate the rear caliper slide rails.
	Lubricate the brake camshafts and slack adjuster (air brakes only).
	Inspect the disc brake pads and the piston boots (hydraulic brakes only).

Every Oil Change	
Clutch	Lubricate the clutch release cross shaft and all linkages.
	Check the clutch fluid level.
Fuel System	Drain the accumulated water or sediment from the fuel tank(s).
Steering System	Lubricate the steering shaft(s), U-joints and splines if equipped with grease fittings.
	Lubricate the front axle spindle pins.
	Lubricate the steering linkage when equipped with grease fittings.
	Lubricate the power steering gear output shaft.

*Coolant protection checks should be made just prior to the onset of freezing weather, where applicable. If coolant is dirty or rusty in appearance, the system should be drained, flushed and refilled with the prescribed solution of cooling system fluid and distilled water. Use only permanent type coolant that meets specifications as listed in your engine operator's manual. See the engine manufacturer's operating guide for supplemental corrosion inhibitor specifications.

Periodic Component/System Checks

The following are vehicle checks that should be made periodically either by the owner or a qualified technician. It is recommended that deficiencies be brought to the attention of your dealer or another qualified service outlet as soon as possible so advice regarding the need for service or replacement can be obtained.

Frequency	Recommended Action
At every engine start up.	Check ABS lamp operation.
After first 500 and 1000 miles (800 and 1600 km), then every 500 and 1000 mile (800 and 1600 km) interval after tire removal or replacement.	Tighten the wheel mounting nuts to the specified torque. See <i>Technical specifications</i> in the <i>Wheels and Tires</i> chapter.
At least twice annually.	Clean body and door drain holes.
As required.	Clean windshield wiper blades.

Observation	Maintenance Operation
Insufficient power shown in loaded practice stop.	Inspect the automatic slack adjuster function.
Subpar vehicle handling qualities.	Check the operation of the brakes, clutch and steering. ^{1,2}
Excessive noise from under the cab or engine compartment.	Inspect the vehicle for missing, damaged or mislocated noise shields.
Excessive engine noise.	Check the engine performance and the engine governor.
Engine overheats; excessive fan noise; fan constantly runs at high speed or wobbles due to worn bearings.	Inspect the fan, fan shroud and fan clutch.
Excessive exhaust noise; smell of exhaust fumes is experienced.	Inspect the entire exhaust system for holes, leaks, breakage, looseness and corrosive damage.
Excessive engine compartment noise.	Inspect the engine air induction system (including air ducts and air filter) for loose, damaged or missing components.
Poor steering; wandering; excessive tire wear.	Check front end alignment, ³ inspect the tires and tire pressure. ³
Vibration or abnormal tire wear indicating imbalance.	Balance the wheels and the tires.
Hard shifting or excessive vibration.	Check the transmission and engine mountings. ²
High effort to shift; noisy transmission.	Check and adjust transmission controls. ²
Insufficient full-throttle power; backfiring.	Check fuel pump pressure.
Radiator cap does not hold pressure.	Clean the cap seal and cap surface on the radiator.
Electrical power supply has diminished.	Check the battery terminals for corrosion.

Observation	Maintenance Operation
Cleaning the wiper blades with a clean cloth and mild detergent and washing with a cleaner does not restore a clean wipe.	Replace wiper blades.
Noisy or difficult to operate.	Lubricate body lock cylinders.
Headlamp beams in wrong position when vehicle operating loaded.	Check headlamp alignment.
Windshield washers do not spray when operated.	Check windshield washer fluid level. Add fluid if required.

¹During maintenance and repair, protect the fuel tube and the hose assemblies, power steering lines, and brake lines from external heat, acids and abrasions that could damage them.

²Check for (free) linkage action and make sure that (return) spring force is adequate to maintain pedal free play.

³Adjust, repair or replace, as required, with the same or equivalent parts.

Emissions Control System



WARNING: Because of high engine compartment and exhaust system temperatures resulting from emissions equipment, do not park, idle or operate your vehicle in dry grass or other dry ground cover where the possibility of ground fire exists.

To make sure the emissions control systems operate effectively, you should have the services listed in the maintenance schedule performed at the specified time and mileage intervals. You should avoid running out of fuel or turning off the ignition while the vehicle is in motion, especially at high speeds.

Do not make unauthorized modifications to the engine or vehicle. Modifications causing increased amounts of unburned fuel to reach the exhaust system can significantly increase the temperature of the engine compartment and the exhaust system.

Avoid driving your vehicle if it does not operate properly. If the engine diesels (more than five seconds of engine run-on after shut-off), misfires, surges, stalls or backfires, see your dealer. Be alert for fluid leakage, odor, smoke, loss of oil pressure, or charge indicator or over temperature warning.

Vehicles equipped with a diesel engine CANNOT use diesel fuel blended with waste oil if equipped with a catalytic converter-muffler. Waste lube oil blending in fuel plugs the catalytic converter-muffler, resulting in a significant loss of engine power.

Noise Emissions Warranty, Prohibited Tampering Acts and Maintenance

On January 1, 1978, Federal regulations became effective governing the noise emissions on trucks over 10000 pounds (4536 kilograms) GVWR. The following statements concerning prohibited tampering acts and maintenance and the noise warranty are found in the warranty information, and are applicable to completed trucks.

Tampering with Noise Control System Prohibited

Federal law prohibits the following acts or the causing thereof: (1) The removal or rendering inoperative, by any person other than for purposes of maintenance, repair or replacement, of any device or element of design incorporated into any new vehicle for the purpose of noise control prior to its sale or delivery to the ultimate purchaser or while it is in use, or (2) the use of the vehicle after such device or element of design has been removed or rendered inoperative by any person.

Among those acts presumed to constitute tampering are the following acts listed:

Vehicle System	Acts
Acoustical shielding	Removal of noise shields, hood blanket, tunnel liner or acoustical absorptive material.
Engine	Removal or rendering inoperative the engine speed governor so as to allow engine speed to exceed manufacturer specifications. Removal of engine mounted noise shield or oil pan enclosure.
Engine air induction	Removal of the air duct, silencer, air cleaner, and/or air cleaner element and baffle in air cleaner; re-indexing of air cleaner.

Vehicle System	Acts
Exhaust	Removal or rendering inoperative exhaust system components including the catalytic converter - muffler assembly, inlet pipe, outlet pipe, resonator and flexpipe. Rotation of horizontal exhaust system directional outlet pipe to cause the exhaust to be emitted in a direction other than the orientation the vehicle was originally produced with.
Engine cooling	Removal or rendering inoperative the fan clutch. Removal or modification of the fan shroud. Replacing a fixed fan with a fan of increased diameter, different number of blades or different pitch width.
DEF (Diesel exhaust fluid)	Removal or rendering inoperative DEF system components including the DEF tank, dosing module, dosing supply module, dosing control unit, NOx electronic module or NOx sensor.

Emissions Control System(s) Laws

Federal law prohibits vehicle manufacturers, dealers and other persons engaged in the business of repairing, servicing, selling, leasing or trading motor vehicles, as well as fleet operators from knowingly removing or rendering an emissions control device or system inoperative. Further, modifications of the emissions control system(s) could create liability on the part of individual owners under the laws of some states. In Canada, modification of the emissions control system could create liability under applicable Federal or Provincial laws.

Maintenance

Instructions for maintenance and service of the noise control system have been included in the required maintenance services and in the general maintenance section. To further help minimize noise emissions degradation throughout the life of the vehicle, Ford Motor Company recommends that this vehicle should be operated in the manner described within this owner's manual. Caution should be exercised by the owner when installing replacement parts to be sure that a tampering act (as outlined above) is not committed. Note any inspection and service performed in the maintenance log.

Emissions Information Label

Emissions information appears on the Important Engine Information decal located on or near the engine.

Scheduled Maintenance Services

Maintenance service adjustments must conform to specifications contained in this manual, and those shown on the Important Engine Information decal. The following services are to be performed at scheduled intervals because they are considered essential to the life and performance of your vehicle. Ford recommends that you perform maintenance on all designated items to achieve best vehicle operation.

Maintenance intervals are provided for three types of general vehicle environments: On-Highway, City and Severe Service. In all applications, the actual interval is determined by monitoring miles (kilometers) and time and when the engine is due for an oil change. When the engine oil change is required prior to the truck lubrication interval, it is recommended that the lubrication be performed at the same time in order to reduce your vehicle's time out of service.

Air Brake Adjustment



WARNING: Failure to maintain proper air brake adjustment can result in reduction or loss of braking ability.

Air brake inspection and adjustment or repairs should be performed by a qualified service technician in accordance with the instructions in the service manual.

Cam Brakes - Automatic Slack Adjusters

WARNING: Do not manually adjust the automatic slack adjusters to correct excessive push rod stroke as it may result in reduced brake effectiveness and a vehicle crash. Excessive push rod stroke indicates that a problem exists with the automatic adjuster, with the installation of the adjuster, or with foundation brake components that manual adjustment does not remedy. Seek service from a qualified facility for excessive push rod stroke.

Inspect standard air brakes equipped with automatic slack adjusters for proper brake adjustment as listed in the maintenance schedule charts.

However, more frequent inspection is required if your vehicle's brakes are subjected to heavy use or adverse operating conditions such as:

- Frequent brake applications while fully loaded.
- Operation on hilly or mountainous terrain.
- Frequent operation on dirt, gravel or mud.

Some aftermarket brake linings also require more frequent inspections.

MAINTENANCE INTERVALS

ON-HIGHWAY - 60000 MILES (96000 KM) OR MORE ANNUALLY (Miles, kilometers or months - whichever occurs first)												
Miles (x 1000)	15	30	45	60	75	90	105	120	135	150		
Kilometers (x 1000)	24	48	72	96	120	144	168	192	216	240		
Months	3	6	9	12	15	18	21	24	27	30		
Engine												
Engine oil and filter - change (diesel engine)	See manufacturer's recommendation.											
Engine oil and filter - change (gasoline engine)	Every 7500 miles (12000 km) or six months											
Engine coolant - check level and concentration	•	•	•	•	•	•	•	•	•	•	•	•
Engine coolant - check freeze-protection and additive (corrosion inhibitor) strength (diesel engine)	•	•	•	•	•	•	•	•	•	•	•	•
Extended life coolant - add extender (diesel engine)	See manufacturer's recommendation.											
Extended life coolant - replace (diesel engine)	See manufacturer's recommendation.											
Engine coolant - replace (gasoline engine)	At six years or 100000 miles (160000 km) (whichever comes first), then every three years or 50000 miles (80000 km)											
Engine air filter - inspect (gasoline engine)	•	•	•	•	•	•	•	•	•	•	•	•
Engine air filter - replace (gasoline engine)	•	•	•	•	•	•	•	•	•	•	•	•
Replace spark plugs												
Inspect accessory drive belt(s)	Inspect at 100000 miles (160000 km) and 120000 miles (192000 km). Replace at 150000 miles (240000 km) if not replaced in the last 100000 miles (160000 km).											

ON-HIGHWAY - 60000 MILES (96000 KM) OR MORE ANNUALLY (Continued)												
(Miles, kilometers or months - whichever occurs first)												
Miles (x 1000)	15	30	45	60	75	90	105	120	135	150		
Kilometers (x 1000)	24	48	72	96	120	144	168	192	216	240		
Months	3	6	9	12	15	18	21	24	27	30		
Non-driving Front Axle												
Drag link/kingpin and bushing/tie rod ends - lubricate	•	•	•	•	•	•	•	•	•	•	•	•
Wheel bearing - grease type - repack		•		•		•		•		•		•
Wheel bearing - oil type - change oil						•						
Wheel bearing - oil type - check level	•	•	•	•	•	•	•	•	•	•	•	•
Brake System												
Master cylinder - check level (hydraulic brakes)	•	•	•	•	•	•	•	•	•	•	•	•
Parking brake relay lever/linkage - lubricate (hydraulic brakes)				•				•				
S-cam - lubricate (air brakes)	•	•	•	•	•	•	•	•	•	•	•	•
Slack adjusters - lubricate (air brakes)					•			•				•
Steering												
Power steering filter - replacement	Every five years or 500000 miles (800000 km)											
Power steering fluid - change						•						
Power steering fluid - check level	•	•	•	•	•	•	•	•	•	•	•	•
Steering column U-joints/slip joint - lubricate	•	•	•	•	•	•	•	•	•	•	•	•
Steering gear Ross TAS - output shaft - lubricate										•		•
Driveshaft												
U-joint - lubricate (SPL)	Every 100000 miles (160000 km) or six months											
U-joint and slip joint - lubricate (non-SPL)	Every 10000-15000 miles (16000-24000 km) or three months											

ON-HIGHWAY - 60000 MILES (96000 KM) OR MORE ANNUALLY (Continued)												
(Miles, kilometers or months - whichever occurs first)												
Miles (x 1000)	15	30	45	60	75	90	105	120	135	150		
Kilometers (x 1000)	24	48	72	96	120	144	168	192	216	240		
Months	3	6	9	12	15	18	21	24	27	30		
Clutch												
Release bearing/shafts/forks - lubricate	•	•	•	•	•	•	•	•	•	•	•	•
Transmission												
Automatic and Auto-shift	See transmission operator's manual.											
Eaton-Fuller manual - petroleum oil - change				•							•	
Eaton-Fuller manual - synthetic oil - change	At 500000 miles (800000 km) if factory-filled with synthetic At 250000 miles (400000 km) if converted to synthetic											
Non-Eaton-Fuller manual - check level	•	•	•	•	•	•	•	•	•	•	•	•
Rear Axle												
Eaton/Dana/Spicer - check level	•	•	•	•	•	•	•	•	•	•	•	•
Eaton/Dana/Spicer - petroleum oil - change												
Eaton/Dana/Spicer - synthetic oil - change	At 500000 miles (800000 km) if factory-filled with synthetic At 250000 miles (400000 km) or three years if converted to synthetic											
Meritor - check level	Every 25000 miles (40000 km) or fleet maintenance interval											
Meritor - filter change	Every 100000 miles (160000 km)											
Meritor - petroleum oil - change	Every 100000 miles (160000 km) or annually											
Meritor - synthetic oil - change	Linehaul: Every 500000 miles (800000 km) or four years Intercity coach: Every 250000 miles (400000 km) or four years											

ON-HIGHWAY - 60000 MILES (96000 KM) OR MORE ANNUALLY (Continued)												
(Miles, kilometers or months - whichever occurs first)												
Miles (x 1000)	15	30	45	60	75	90	105	120	135	150		
Kilometers (x 1000)	24	48	72	96	120	144	168	192	216	240		
Months	3	6	9	12	15	18	21	24	27	30		
Cab Components												
Door hinges/latches/strikers/lock cylinders - lubricate					•						•	
Seat adjuster slides - lubricate												
Diesel Exhaust Fluid (DEF) System												
Check and refill DEF system	•	•	•	•	•	•	•	•	•	•	•	•

ON-HIGHWAY - 60000 MILES (96000 KM) OR MORE ANNUALLY (Miles, kilometers or months - whichever occurs first)											
Miles (x 1000)	165	180	195	210	225	240	255	270	285	300	
Kilometers (x 1000)	264	288	312	336	360	384	408	432	456	480	
Months	33	36	39	42	45	48	51	54	57	60	
Engine											
Engine oil and filter - change (diesel engine)	See manufacturer's recommendation.										
Engine oil and filter - change (gasoline engine)	Every 7500 miles (12000 km) or six months										
Engine coolant - check level and concentration	•	•	•	•	•	•	•	•	•	•	•
Engine coolant - check freeze-protection and additive (corrosion inhibitor) strength (diesel engine)	•	•	•	•	•	•	•	•	•	•	•
Extended life coolant - add extender (diesel engine)	See manufacturer's recommendation.										
Extended life coolant - replace (diesel engine)	See manufacturer's recommendation.										
Engine coolant - replace (gasoline engine)	At six years or 100000 miles (160000 km) (whichever comes first), then every three years or 50000 miles (80000 km)										
Engine air filter - inspect (gasoline engine)	•	•	•	•	•	•	•	•	•	•	•
Engine air filter - replace (gasoline engine)	•	•	•	•	•	•	•	•	•	•	•
Replace spark plugs	•	•	•	•	•	•	•	•	•	•	•
Inspect accessory drive belt(s)	Inspect at 100000 miles (160000 km) and 120000 miles (192000 km). Replace at 150000 miles (240000 km) if not replaced in the last 100000 miles (160000 km).										

ON-HIGHWAY - 60000 MILES (96000 KM) OR MORE ANNUALLY (Continued)												
(Miles, kilometers or months - whichever occurs first)												
Miles (x 1000)	165	180	195	210	225	240	255	270	285	300		
Kilometers (x 1000)	264	288	312	336	360	384	408	432	456	480		
Months	33	36	39	42	45	48	51	54	57	60		
Non-driving Front Axle												
Drag link/kingpin and bushing/tie rod ends - lubricate	•	•	•	•	•	•	•	•	•	•	•	•
Wheel bearing - grease type - repack		•		•		•		•		•		•
Wheel bearing - oil type - change oil		•								•		
Wheel bearing - oil type - check level	•	•	•	•	•	•	•	•	•	•	•	•
Brake System												
Master cylinder - check level (hydraulic brakes)	•	•	•	•	•	•	•	•	•	•	•	•
Parking brake relay lever/linkage - lubricate (hydraulic brakes)						•						
S-cam - lubricate (air brakes)	•	•	•	•	•	•	•	•	•	•	•	•
Slack adjusters - lubricate (air brakes)		•				•				•		•
Steering												
Power steering filter - replacement												Five years or 500000 miles (800000 km)
Power steering fluid - change		•										•
Power steering fluid - check level	•	•	•	•	•	•	•	•	•	•	•	•
Steering column U-joints/slip joint - lubricate	•	•	•	•	•	•	•	•	•	•	•	•
Steering gear Ross TAS - output seal - lubricate		•				•				•		•
Driveshaft												
U-joint - lubricate (SPL)												Every 100000 miles (160000 km) or six months
U-joint and slip joint - lubricate (non-SPL)												Every 10000-15000 miles (16000-24000 km) or three months

ON-HIGHWAY - 60000 MILES (96000 KM) OR MORE ANNUALLY (Continued)										
(Miles, kilometers or months - whichever occurs first)										
Miles (x 1000)	165	180	195	210	225	240	255	270	285	300
Kilometers (x 1000)	264	288	312	336	360	384	408	432	456	480
Months	33	36	39	42	45	48	51	54	57	60
Clutch										
Release bearing/shafts/fork - lubricate	•	•	•	•	•	•	•	•	•	•
Transmission										
Automatic and Auto-shift	See transmission operator's manual.									
Eaton-Fuller manual - petroleum oil - change	•					•				•
Eaton-Fuller manual - synthetic oil - change	Factory fill with synthetic at 500000 miles (800000 km) Converted to synthetic at 250000 miles (400000 km)									
Non-Eaton-Fuller manual - check level	•	•	•	•	•	•	•	•	•	•
Rear Axle										
Eaton/Dana/Spicer - check level	•	•	•	•	•	•	•	•	•	•
Eaton/Dana/Spicer - petroleum oil - change	•					•				•
Eaton/Dana/Spicer - synthetic oil - change	At 500000 miles (800000 km) if factory-filled with synthetic At 250000 miles (400000 km) or three years if converted to synthetic									
Meritor - check level	Every 25000 miles (40000 km), or fleet maintenance interval									
Meritor - filter change	Every 100000 miles (160000 km)									
Meritor - petroleum oil - change	Every 100000 miles (160000 km) or annually									
Meritor - synthetic oil - change	Linehaul: Every 500000 miles (800000 km) or four years Intercity coach: Every 250000 miles (400000 km) or four years									

ON-HIGHWAY - 60000 MILES (96000 KM) OR MORE ANNUALLY (Continued)												
(Miles, kilometers or months - whichever occurs first)												
Miles (x 1000)	165	180	195	210	225	240	255	270	285	300		
Kilometers (x 1000)	264	288	312	336	360	384	408	432	456	480		
Months	33	36	39	42	45	48	51	54	57	60		
Cab Components												
Door hinges/latches/strikers/lock cylinders - lubricate		•								•		•
Seat adjuster slides - lubricate		•								•		•
Diesel Exhaust Fluid (DEF) System												
Check and refill DEF system	•	•	•	•	•	•	•	•	•	•	•	•

CITY - 60000 MILES (96000 KM) OR FEWER ANNUALLY (Miles, kilometers or months - whichever occurs first)											
Miles (x 1000)	10	20	30	40	50	60	70	80	90	100	
Kilometers (x 1000)	16	32	48	64	80	96	112	128	144	160	
Months	3	6	9	12	15	18	21	24	27	30	
Engine											
Engine oil and filter - change (diesel engine)	See manufacturer's recommendation.										
Engine oil and filter - change (gasoline engine)	Every 5000 miles (8000 km) or six months										
Engine coolant - check level and concentration	•	•	•	•	•	•	•	•	•	•	•
Engine coolant - check freeze-protection and additive (corrosion inhibitor) strength (diesel engine)	•	•	•	•	•	•	•	•	•	•	•
Extended life coolant - add extender (diesel engine)	See manufacturer's recommendation.										
Extended life coolant - replace (diesel engine)	See manufacturer's recommendation.										
Engine coolant - replace (gasoline engine)	At six years or 100000 miles (160000 km) (whichever comes first), then every three years or 50000 miles (80000 km)										
Engine air filter - inspect (gasoline engine)	•	•	•	•	•	•	•	•	•	•	•
Engine air filter - replace (gasoline engine)		•				•			•		•
Replace spark plugs									•		
Inspect accessory drive belt(s)	Inspect at 100000 miles (160000 km) and 120000 miles (192000 km). Replace at 150000 miles (240000 km) if not replaced in the last 100000 miles (160000 km).										
Non-driving Front Axle											
Drag link/kingpin and bushing/tie rod ends - lubricate	•	•	•	•	•	•	•	•	•	•	•
Wheel bearing - grease type - repack				•					•		
Wheel bearing - oil type - change oil									•		
Wheel bearing - oil type - check level	•	•	•	•	•	•	•	•	•	•	•

CITY - 60000 MILES (96000 KM) OR FEWER ANNUALLY (Continued)											
(Miles, kilometers or months - whichever occurs first)											
Miles (x 1000)	10	20	30	40	50	60	70	80	90	100	
Kilometers (x 1000)	16	32	48	64	80	96	112	128	144	160	
Months	3	6	9	12	15	18	21	24	27	30	
Brake System											
Master cylinder - check level (hydraulic brakes)	•	•	•	•	•	•	•	•	•	•	•
Parking brake relay lever/linkage - lubricate (hydraulic brakes)			•			•				•	
S-cam - lubricate (air brakes)	•	•	•	•	•	•	•	•	•	•	•
Slack adjusters - lubricate (air brakes)				•						•	
Steering											
Power steering filter - replacement											Five years or 50000 miles (80000 km)
Power steering fluid - change				•						•	
Power steering fluid - check level	•	•	•	•	•	•	•	•	•	•	•
Steering column U-joints/slip joint - lubricate	•	•	•	•	•	•	•	•	•	•	•
Steering gear Ross TAS - output seal - lubricate			•							•	
Driveshaft											
U-joint - lubricate (SPL)	Every 25000 miles (40000 km) or six months (whichever comes first)										
U-joint and slip joint - lubricate (non-SPL)	Every 5000-8000 miles (8000 km-12000 km) or three months (whichever comes first)										
Clutch											
Release bearing/shafts/forks - lubricate	•	•	•	•	•	•	•	•	•	•	•

CITY - 60000 MILES (96000 KM) OR FEWER ANNUALLY (Continued) (Miles, kilometers or months - whichever occurs first)											
Miles (x 1000)	10	20	30	40	50	60	70	80	90	100	
Kilometers (x 1000)	16	32	48	64	80	96	112	128	144	160	
Months	3	6	9	12	15	18	21	24	27	30	
Transmission											
Automatic and Auto-shift	See transmission operator's manual.										
Eaton-Fuller manual - petroleum oil - change					•						•
Non-Eaton-Fuller manual - check level	•	•	•	•	•	•	•	•	•	•	•
Rear Axle											
Eaton/Dana/Spicer - check level	•	•	•	•	•	•	•	•	•	•	•
Eaton/Dana/Spicer - petroleum oil - change					•						•
Meritor - check level	Every 10000 miles (16000 km), once a month or fleet maintenance interval (whichever comes first)										
Meritor - filter change	Every 100000 miles (160000 km)										
Meritor - petroleum oil - change	Every 50000 miles (80000 km) or annually (whichever comes first)										
Meritor - synthetic oil - change	Every 250000 miles (400000 km) or every three years (whichever comes first)										
Cab Components											
Door hinges/latches/strikers/lock cylinders - lubricate			•								•
Seat adjuster slides - lubricate			•								•
Diesel Exhaust Fluid (DEF) System											
Check and refill DEF system	•	•	•	•	•	•	•	•	•	•	•

CITY - 60000 MILES (96000 KM) OR FEWER ANNUALLY (Miles, kilometers or months - whichever occurs first)												
Miles (x 1000)	110	120	130	140	150	160	170	180	190	200		
Kilometers (x 1000)	176	192	208	224	240	256	272	288	304	320		
Months	33	36	39	42	45	48	51	54	57	60		
Engine												
Engine oil and filter - change (diesel engine)	See manufacturer's recommendation.											
Engine oil and filter - change (gasoline engine)	Every 5000 miles (8000 km) or six months											
Engine coolant - check level and concentration	•	•	•	•	•	•	•	•	•	•	•	•
Engine coolant - check freeze-protection and additive (corrosion inhibitor) strength (diesel engine)	•	•	•	•	•	•	•	•	•	•	•	•
Extended life coolant - add extender (diesel engine)	See manufacturer's recommendation.											
Extended life coolant - replace (diesel engine)	See manufacturer's recommendation.											
Engine coolant - replace (gasoline engine)	At six years or 100000 miles (160000 km) (whichever comes first), then every three years or 50000 miles (80000 km)											
Engine air filter - inspect (gasoline engine)	•	•	•	•	•	•	•	•	•	•	•	•
Engine air filter - replace (gasoline engine)	•	•	•	•	•	•	•	•	•	•	•	•
Replace spark plugs	•	•	•	•	•	•	•	•	•	•	•	•
Inspect accessory drive belt(s)	Inspect at 100000 miles (160000 km) and 120000 miles (192000 km). Replace at 150000 miles (240000 km) if not replaced in the last 100000 miles (160000 km).											
Non-driving Front Axle												
Drag link/kingpin and bushing/tie rod ends - lubricate	•	•	•	•	•	•	•	•	•	•	•	•
Wheel bearing - grease type - repack	•	•	•	•	•	•	•	•	•	•	•	•
Wheel bearing - oil type - change oil	•	•	•	•	•	•	•	•	•	•	•	•
Wheel bearing - oil type - check level	•	•	•	•	•	•	•	•	•	•	•	•

CITY - 60000 MILES (96000 KM) OR FEWER ANNUALLY (Continued)												
(Miles, kilometers or months - whichever occurs first)												
Miles (x 1000)	110	120	130	140	150	160	170	180	190	200		
Kilometers (x 1000)	176	192	208	224	240	256	272	288	304	320		
Months	33	36	39	42	45	48	51	54	57	60		
Brake System												
Master cylinder - check level	•	•	•	•	•	•	•	•	•	•	•	•
Parking brake relay lever/linkage - lubricate		•			•			•				
S-cam - lubricate	•	•	•	•	•	•	•	•	•	•	•	•
Slack adjusters - lubricate		•						•				•
Steering												
Power steering filter - replacement	Five years or 50000 miles (80000 km)											
Power steering fluid - change	•					•						•
Power steering fluid - check level	•	•	•	•	•	•	•	•	•	•	•	•
Steering column U-joints/slip joint - lubricate	•	•	•	•	•	•	•	•	•	•	•	•
Steering gear Ross TAS - output seal - lubricate		•										•
Driveshaft												
U-joint - lubricate (SPL)	Every 25000 miles (40000 km) or six months (whichever comes first)											
U-joint and slip joint - lubricate (non-SPL)	Every 5000-8000 miles (8000 km-12000 km) or three months (whichever comes first)											
Clutch												
Release bearing/shafts/fork - lubricate	•	•	•	•	•	•	•	•	•	•	•	•

Scheduled Maintenance

CITY - 60000 MILES (96000 KM) OR FEWER ANNUALLY (Continued)											
(Miles, kilometers or months - whichever occurs first)											
Miles (x 1000)	110	120	130	140	150	160	170	180	190	200	
Kilometers (x 1000)	176	192	208	224	240	256	272	288	304	320	
Months	33	36	39	42	45	48	51	54	57	60	
Transmission											
Automatic and Auto-shift	See transmission operator's manual.										
Eaton-Fuller manual - petroleum oil - change					•						•
Eaton-Fuller manual - synthetic oil - change		•									
Non-Eaton-Fuller manual - check level					•						•
Rear Axle											
Eaton/Dana/Spicer - check level	•	•	•	•	•	•	•	•	•	•	•
Eaton/Dana/Spicer - petroleum oil - change					•						•
Eaton/Dana/Spicer - synthetic oil - change		•									
Meritor - check level	Every 10000 miles (16000 km), once a month, or fleet maintenance interval (whichever comes first)										
Meritor - filter change	Every 100000 miles (160000 km)										
Meritor - petroleum oil - change	Every 50000 miles (80000 km) or annually (whichever comes first)										
Meritor - synthetic oil - change	Every 250000 miles (400000 km) or every three years (whichever comes first)										
Cab Components											
Door hinges/latches/strikers/lock cylinders - lubricate		•				•					•
Seat adjuster slides - lubricate		•				•					•
Diesel Exhaust Fluid (DEF) System											
Check and refill DEF system	•	•	•	•	•	•	•	•	•	•	•

SEVERE SERVICE - ON/OFF ROAD IN DIRTY CONDITIONS OR 20000 MILES (32000 KM) OR FEWER ANNUALLY (Miles, kilometers or months - whichever occurs first)												
Miles (x 1000)	5	10	15	20	25	30	35	40	45	50		
Kilometers (x 1000)	8	16	24	32	40	48	56	64	72	80		
Months	3	6	9	12	15	18	21	24	27	30		
Engine												
Engine oil and filter - change (diesel engine)	See manufacturer's recommendation.											
Engine oil and filter - change (gasoline engine)	Every 5000 miles (8000 km) or three months (See note at end of table regarding alternate schedule.)											
Engine coolant - check level and concentration	•	•	•	•	•	•	•	•	•	•	•	•
Engine coolant - check freeze-protection and additive (corrosion inhibitor) strength (diesel engine)	•	•	•	•	•	•	•	•	•	•	•	•
Extended life coolant - add extender (diesel engine)	See manufacturer's recommendation.											
Extended life coolant - replace (diesel engine)	See manufacturer's recommendation.											
Engine coolant - replace (gasoline engine)	At six years or 100000 miles (160000 km) (whichever comes first), then every three years or 50000 miles (80000 km)											
Engine air filter - inspect (gasoline engine)	•	•	•	•	•	•	•	•	•	•	•	•
Engine air filter - replace (gasoline engine)											•	
Non-driving Front Axle												
Drag link/kingpin and bushing/tie rod ends - lubricate	•	•	•	•	•	•	•	•	•	•	•	•
Wheel bearing - grease type - repack				•							•	
Wheel bearing - oil type - change oil				•							•	
Wheel bearing - oil type - check level	•	•	•	•	•	•	•	•	•	•	•	•

SEVERE SERVICE - ON/OFF ROAD IN DIRTY CONDITIONS OR 20000 MILES (32000 KM) OR FEWER ANNUALLY (Continued)												
	(Miles, kilometers or months - whichever occurs first)											
Miles (x 1000)	5	10	15	20	25	30	35	40	45	50		
Kilometers (x 1000)	8	16	24	32	40	48	56	64	72	80		
Months	3	6	9	12	15	18	21	24	27	30		
Brake System												
Master cylinder - check fluid level (hydraulic brakes)	•			•								
Parking brake relay lever/linkage - lubricate (hydraulic brakes)			•			•						•
S-cam - lubricate (air brakes)	•	•	•	•	•	•	•	•	•	•	•	•
Slack adjusters - lubricate (air brakes)				•								•
Steering												
Power steering fluid - change					•							•
Power steering fluid - check level	•	•	•	•	•	•	•	•	•	•	•	•
Steering column U-joints/slip joints - lubricate	•	•	•	•	•	•	•	•	•	•	•	•
Steering gear Ross TAS - output seal - lubricate												•
Driveshaft												
Slip joint - inspect boot; U-joint - lubricate (SPL)	Every 25000 miles (40000 km) or six months (whichever comes first)											
U-joint and slip joint - lubricate (non-SPL)	Every 5000-8000 miles (8000-12000 km) or three months (whichever comes first)											
Clutch												
Release bearing/shafts/forks	•	•	•	•	•	•	•	•	•	•	•	•

SEVERE SERVICE - ON/OFF ROAD IN DIRTY CONDITIONS OR 20000 MILES (32000 KM) OR FEWER ANNUALLY (Continued)											
(Miles, kilometers or months - whichever occurs first)											
Miles (x 1000)	5	10	15	20	25	30	35	40	45	50	
Kilometers (x 1000)	8	16	24	32	40	48	56	64	72	80	
Months	3	6	9	12	15	18	21	24	27	30	
Transmission											
Automatic and Auto-shift	See transmission operator's manual.										
Eaton-Fuller manual - petroleum oil - change											
Non-Eaton-Fuller manual - check level	•	•	•	•	•	•	•	•	•	•	•
Rear Axle											
Eaton/Dana/Spicer - check level	•	•	•	•	•	•	•	•	•	•	•
Eaton/Dana/Spicer - petroleum oil - change											
Eaton/Dana/Spicer - synthetic oil - change											
Meritor - check level	Every 5000 miles (8000 km), once a month, or fleet maintenance interval (whichever comes first). For continuous heavy-duty operation, check level every 1000 miles (1600 km).										
Meritor - filter change	Every 100000 miles (160000 km)										
Meritor - petroleum oil - change	Every 25000 miles (40000 km) or annually (whichever comes first)										
Meritor - synthetic oil - change	Every 100000 miles (160000 km) or annually (whichever comes first)										

SEVERE SERVICE - ON/OFF ROAD IN DIRTY CONDITIONS OR 20000 MILES (32000 KM) OR FEWER ANNUALLY (Continued)												
(Miles, kilometers or months - whichever occurs first)												
Miles (x 1000)	5	10	15	20	25	30	35	40	45	50		
Kilometers (x 1000)	8	16	24	32	40	48	56	64	72	80		
Months	3	6	9	12	15	18	21	24	27	30		
Cab Components												
Door hinges/latches/strikers/lock cylinders - lubricate					•							•
Seat adjuster slides - lubricate					•							•
Diesel Exhaust Fluid (DEF) System												
Check and refill DEF system	•	•	•	•	•	•	•	•	•	•	•	•

Note: If your vehicle is equipped with a gasoline engine, the engine oil and filter changes should observe the normal schedule unless conditions, such as low-speed operation or stationary use, exist where a schedule based on engine hours is recommended. In this type of schedule, the engine oil and filter should be replaced every 250 engine hours.

SEVERE SERVICE - ON/OFF ROAD IN DIRTY CONDITIONS OR 20000 MILES (32000 KM) OR FEWER ANNUALLY (Miles, kilometers or months - whichever occurs first)											
Miles (x 1000)	55	60	65	70	75	80	85	90	95	100	
Kilometers (x 1000)	88	96	104	112	120	128	136	144	152	160	
Months	33	36	39	42	45	48	51	54	57	60	
Engine											
Engine oil and filter - change (diesel engine)	See manufacturer's recommendation.										
Engine oil and filter - change (gasoline engine)	Every 5000 miles (8000 km) or three months (see note at end of table regarding alternate schedule)										
Engine coolant - check level and concentration	•	•	•	•	•	•	•	•	•	•	•
Engine coolant - check freeze-protection and additive (corrosion inhibitor) strength (diesel engine)	•	•	•	•	•	•	•	•	•	•	•
Extended life coolant - add extender (diesel engine)	See manufacturer's recommendation.										
Extended life coolant - replace (diesel engine)	See manufacturer's recommendation.										
Engine coolant - replace (gasoline engine)	At six years or 100000 miles (160000 km) (whichever comes first), then every three years or 50000 miles (80000 km)										
Engine air filter - inspect (gasoline engine)	•	•	•	•	•	•	•	•	•	•	•
Engine air filter - replace (gasoline engine)	•	•	•	•	•	•	•	•	•	•	•
Replace spark plugs	•	•	•	•	•	•	•	•	•	•	•
Inspect accessory drive belt(s)	Inspect at 100000 miles (160000 km) and 120000 miles (192000 km). Replace at 150000 miles (240000 km) if not replaced in the last 100000 miles (160000 km).										

SEVERE SERVICE - ON/OFF ROAD IN DIRTY CONDITIONS OR 20000 MILES (32000 KM) OR FEWER ANNUALLY (Continued)												
(Miles, kilometers or months - whichever occurs first)												
Miles (x 1000)	55	60	65	70	75	80	85	90	95	100		
Kilometers (x 1000)	88	96	104	112	120	128	136	144	152	160		
Months	33	36	39	42	45	48	51	54	57	60		
Non-driving Front Axle												
Drag link/kingpin and bushing/tie rod ends - lubricate	•	•	•	•	•	•	•	•	•	•	•	•
Wheel bearing - grease type - repack		•				•				•		•
Wheel bearing - oil type - change oil		•				•				•		•
Wheel bearing - oil type - check level	•	•	•	•	•	•	•	•	•	•	•	•
Brake System												
Master cylinder - check fluid level (hydraulic brakes)	•	•	•	•	•	•	•	•	•	•	•	•
Parking brake relay lever/linkage - lubricate (hydraulic brakes)		•			•			•				
S-cam - lubricate (air brakes)	•	•	•	•	•	•	•	•	•	•	•	•
Slack adjusters - lubricate (air brakes)		•				•				•		•
Steering												
Power steering filter - replacement		•										
Power steering fluid - change		•				•				•		•
Power steering fluid - check level	•	•	•	•	•	•	•	•	•	•	•	•
Steering column U-joints/slip joint - lubricate	•	•	•	•	•	•	•	•	•	•	•	•
Steering gear Ross TAS - output seal - lubricate		•				•				•		•

SEVERE SERVICE - ON/OFF ROAD IN DIRTY CONDITIONS OR 20000 MILES (32000 KM) OR FEWER ANNUALLY (Continued)											
(Miles, kilometers or months - whichever occurs first)											
Miles (x 1000)	55	60	65	70	75	80	85	90	95	100	
Kilometers (x 1000)	88	96	104	112	120	128	136	144	152	160	
Months	33	36	39	42	45	48	51	54	57	60	
Driveshaft											
Slip joint - inspect boot; U-joint - lubricate (SPL)	Every 25000 miles (40000 km) or six months (whichever comes first)										
U-joint and slip joint - lubricate (non-SPL)	Every 5000-8000 miles (8000-12000 km) or three months (whichever comes first)										
Clutch											
Release bearing/shafts/fork - lubricate	•	•	•	•	•	•	•	•	•	•	•
Transmission											
Automatic and Auto-shift	See transmission operator's manual.										
Non-Eaton-Fuller manual - check level	•	•	•	•	•	•	•	•	•	•	•
Eaton-Fuller manual - petroleum oil - change	•										•
Eaton-Fuller manual - synthetic oil - change	•										•
Rear Axle											
Eaton/Dana/Spicer - check level	•	•	•	•	•	•	•	•	•	•	•
Eaton/Dana/Spicer - petroleum oil - change	•										•
Eaton/Dana/Spicer - synthetic oil - change	•										•
Meritor - check level	Every 5000 miles (8000 km), once a month, or fleet maintenance interval (whichever comes first). For continuous heavy-duty operation, check level every 1000 miles (1600 km).										

SEVERE SERVICE - ON/OFF ROAD IN DIRTY CONDITIONS OR 20000 MILES (32000 KM) OR FEWER ANNUALLY (Continued)												
(Miles, kilometers or months - whichever occurs first)												
Miles (x 1000)	55	60	65	70	75	80	85	90	95	100		
Kilometers (x 1000)	88	96	104	112	120	128	136	144	152	160		
Months	33	36	39	42	45	48	51	54	57	60		
Meritor - filter change	Every 100000 miles (160000 km)											
Meritor - petroleum oil - change	Every 25000 miles (40000 km) or annually (whichever comes first)											
Meritor - synthetic oil - change	Every 100000 miles (160000 km) or annually (whichever comes first)											
Cab Components												
Door hinges/latches/strikers/lock cylinders - lubricate	•											•
Seat adjuster slides - lubricate	•											•
Diesel Exhaust Fluid (DEF) System												
Check and refill DEF system	•	•	•	•	•	•	•	•	•	•	•	•

Note: If your vehicle is equipped with a gasoline engine, the engine oil and filter changes should observe the normal schedule unless conditions, such as low-speed operation or stationary use, exist where a schedule based on engine hours is recommended. In this type of schedule, the engine oil and filter should be replaced every 250 engine hours.

Maintenance Record Retention and Service Log

MAINTENANCE SERVICES AND RECORD RETENTION

The maintenance record form which follows is for your convenience. In addition to recording the services performed, you should retain copies of your receipts for the services. You also should keep records of any emission control systems maintenance services performed on your vehicle.

Maintenance Record

Warranty _____
Start Date _____ Engine Displacement _____
Vehicle Identification Number _____ Owner Name _____

IMPORTANT — This document should remain with the vehicle at all times.

Scheduled Maintenance

<p style="text-align: center;">DEALER VALIDATION:</p> <p style="text-align: center;">P&A CODE:</p> <p>RO#: HOURS:</p> <p>DATE: MILEAGE:</p>	<p style="text-align: center;">DEALER VALIDATION:</p> <p style="text-align: center;">P&A CODE:</p> <p>RO#: HOURS:</p> <p>DATE: MILEAGE:</p>
<p style="text-align: center;">DEALER VALIDATION:</p> <p style="text-align: center;">P&A CODE:</p> <p>RO#: HOURS:</p> <p>DATE: MILEAGE:</p>	<p style="text-align: center;">DEALER VALIDATION:</p> <p style="text-align: center;">P&A CODE:</p> <p>RO#: HOURS:</p> <p>DATE: MILEAGE:</p>
<p style="text-align: center;">DEALER VALIDATION:</p> <p style="text-align: center;">P&A CODE:</p> <p>RO#: HOURS:</p> <p>DATE: MILEAGE:</p>	<p style="text-align: center;">DEALER VALIDATION:</p> <p style="text-align: center;">P&A CODE:</p> <p>RO#: HOURS:</p> <p>DATE: MILEAGE:</p>
<p style="text-align: center;">DEALER VALIDATION:</p> <p style="text-align: center;">P&A CODE:</p> <p>RO#: HOURS:</p> <p>DATE: MILEAGE:</p>	<p style="text-align: center;">DEALER VALIDATION:</p> <p style="text-align: center;">P&A CODE:</p> <p>RO#: HOURS:</p> <p>DATE: MILEAGE:</p>
<p style="text-align: center;">DEALER VALIDATION:</p> <p style="text-align: center;">P&A CODE:</p> <p>RO#: HOURS:</p> <p>DATE: MILEAGE:</p>	<p style="text-align: center;">DEALER VALIDATION:</p> <p style="text-align: center;">P&A CODE:</p> <p>RO#: HOURS:</p> <p>DATE: MILEAGE:</p>

Scheduled Maintenance

317

<p style="text-align: center;">DEALER VALIDATION:</p> <p style="text-align: center;">P&A CODE:</p> <p>RO#: HOURS:</p> <p>DATE: MILEAGE:</p>	<p style="text-align: center;">DEALER VALIDATION:</p> <p style="text-align: center;">P&A CODE:</p> <p>RO#: HOURS:</p> <p>DATE: MILEAGE:</p>
<p style="text-align: center;">DEALER VALIDATION:</p> <p style="text-align: center;">P&A CODE:</p> <p>RO#: HOURS:</p> <p>DATE: MILEAGE:</p>	<p style="text-align: center;">DEALER VALIDATION:</p> <p style="text-align: center;">P&A CODE:</p> <p>RO#: HOURS:</p> <p>DATE: MILEAGE:</p>
<p style="text-align: center;">DEALER VALIDATION:</p> <p style="text-align: center;">P&A CODE:</p> <p>RO#: HOURS:</p> <p>DATE: MILEAGE:</p>	<p style="text-align: center;">DEALER VALIDATION:</p> <p style="text-align: center;">P&A CODE:</p> <p>RO#: HOURS:</p> <p>DATE: MILEAGE:</p>
<p style="text-align: center;">DEALER VALIDATION:</p> <p style="text-align: center;">P&A CODE:</p> <p>RO#: HOURS:</p> <p>DATE: MILEAGE:</p>	<p style="text-align: center;">DEALER VALIDATION:</p> <p style="text-align: center;">P&A CODE:</p> <p>RO#: HOURS:</p> <p>DATE: MILEAGE:</p>
<p style="text-align: center;">DEALER VALIDATION:</p> <p style="text-align: center;">P&A CODE:</p> <p>RO#: HOURS:</p> <p>DATE: MILEAGE:</p>	<p style="text-align: center;">DEALER VALIDATION:</p> <p style="text-align: center;">P&A CODE:</p> <p>RO#: HOURS:</p> <p>DATE: MILEAGE:</p>

Scheduled Maintenance

<p style="text-align: center;">DEALER VALIDATION:</p> <p style="text-align: center;">P&A CODE:</p> <p>RO#: HOURS:</p> <p>DATE: MILEAGE:</p>	<p style="text-align: center;">DEALER VALIDATION:</p> <p style="text-align: center;">P&A CODE:</p> <p>RO#: HOURS:</p> <p>DATE: MILEAGE:</p>
<p style="text-align: center;">DEALER VALIDATION:</p> <p style="text-align: center;">P&A CODE:</p> <p>RO#: HOURS:</p> <p>DATE: MILEAGE:</p>	<p style="text-align: center;">DEALER VALIDATION:</p> <p style="text-align: center;">P&A CODE:</p> <p>RO#: HOURS:</p> <p>DATE: MILEAGE:</p>
<p style="text-align: center;">DEALER VALIDATION:</p> <p style="text-align: center;">P&A CODE:</p> <p>RO#: HOURS:</p> <p>DATE: MILEAGE:</p>	<p style="text-align: center;">DEALER VALIDATION:</p> <p style="text-align: center;">P&A CODE:</p> <p>RO#: HOURS:</p> <p>DATE: MILEAGE:</p>
<p style="text-align: center;">DEALER VALIDATION:</p> <p style="text-align: center;">P&A CODE:</p> <p>RO#: HOURS:</p> <p>DATE: MILEAGE:</p>	<p style="text-align: center;">DEALER VALIDATION:</p> <p style="text-align: center;">P&A CODE:</p> <p>RO#: HOURS:</p> <p>DATE: MILEAGE:</p>
<p style="text-align: center;">DEALER VALIDATION:</p> <p style="text-align: center;">P&A CODE:</p> <p>RO#: HOURS:</p> <p>DATE: MILEAGE:</p>	<p style="text-align: center;">DEALER VALIDATION:</p> <p style="text-align: center;">P&A CODE:</p> <p>RO#: HOURS:</p> <p>DATE: MILEAGE:</p>

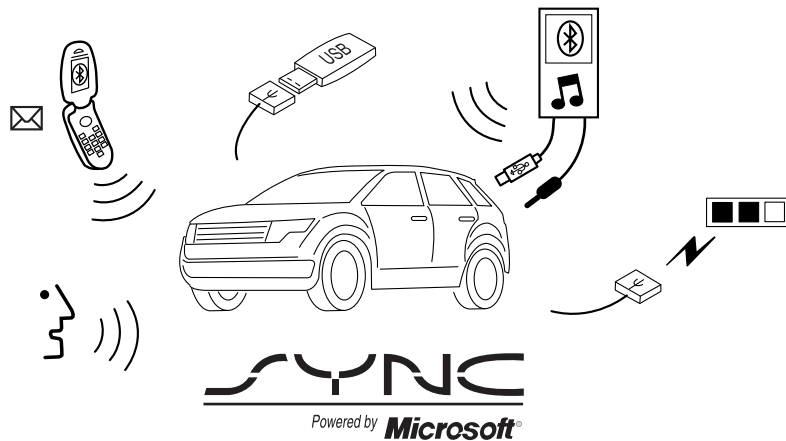

SYNC is an in-vehicle communications system that works with your Bluetooth-enabled cellular phone and portable media player. This allows you to:

- Make and receive calls.
- Access and play music from your portable music player.
- Use 911 Assist, Vehicle Health Report and SYNC Services (Traffic, Directions & Information) (if equipped).
- Use applications, such as Pandora and Stitcher, via SYNC AppLink™ (if applicable).
- Access phonebook contacts and music via voice commands.
- Stream music from your connected phone.
- Text message.
- Use the advanced voice recognition system.
- USB device charging (if your device supports this).

GENERAL INFORMATION

Make sure you review your device's manual before using it with SYNC.

Support

The SYNC support team is available to help you with any questions you cannot answer on your own.

Monday-Saturday, 8:30am-8:00pm EST.

In the United States, call: 1-888-270-1055.

In Canada, call: 1-800-565-3673.

Times are subject to change due to holidays.

SYNC Owner Account

Why do I need a SYNC owner account?

- Required to activate Vehicle Health Report and to view the reports online.
- Required to activate the subscription-based SYNC Services and to personalize your Saved Points and Favorites.
- Essential for keeping up with the latest software downloads available for SYNC.
- Access to customer support for any questions you may have.

Driving Restrictions

For your safety, certain features are speed-dependent and restricted when your vehicle is traveling over 3 mph (5 km/h).

Safety Information

WARNING: Driving while distracted can result in loss of vehicle control, crash and injury. We strongly recommend that you use extreme caution when using any device that may take your focus off the road. Your primary responsibility is the safe operation of your vehicle. We recommend against the use of any handheld device while driving and encourage the use of voice-operated systems when possible. Make sure you are aware of all applicable local laws that may affect the use of electronic devices while driving.

When using SYNC:

- Do not operate playing devices if the power cords or cables are broken, split or damaged. Place cords and cables out of the way, so they do not interfere with the operation of pedals, seats, compartments or safe driving abilities.

- Do not leave playing devices in your vehicle during extreme conditions as it could cause them damage. See your device's manual for further information.
- Do not attempt to service or repair the system. See your authorized dealer.

For your safety, some SYNC functions are speed-dependent. Their use is limited to when your vehicle is traveling at speeds under 3 mph (5 km/h).

Make sure that you review your device's manual before using it with SYNC.

Privacy Information

When a cellular phone is connected to SYNC, the system creates a profile within your vehicle that is linked to that cellular phone. This profile is created in order to offer you more cellular features and to operate more efficiently. Among other things, this profile may contain data about your cellular phone book, text messages (read and unread), and call history, including history of calls when your cell phone was not connected to the system. In addition, if you connect a media device, the system creates and retains an index of supported media content. The system also records a short development log of approximately 10 minutes of all recent system activity. The log profile and other system data may be used to improve the system and help diagnose any problems that may occur.

The cellular profile, media device index, and development log remain in the vehicle unless you delete them and are generally accessible only in the vehicle when the cellular phone or media player is connected. If you no longer plan to use the system or the vehicle, we recommend you perform a Master Reset to erase all stored information.

System data cannot be accessed without special equipment and access to the vehicle's SYNC module. Ford Motor Company and Ford of Canada do not access the system data for any purpose other than as described absent consent, a court order, or where required by law enforcement, other government authorities, or other third parties acting with lawful authority. Other parties may seek to access the information independently of Ford Motor Company and Ford of Canada. For further privacy information, see the sections on 911 Assist, Vehicle Health Report, and Traffic, Directions and Information.

USING VOICE RECOGNITION

This system helps you control many features using voice commands. This allows you to keep your hands on the wheel and focus on what is in front of you.

Initiating a Voice Session



Push the voice icon; a tone sounds and Listening appears in the display. Say any of the following:

Say:	If you want to:
“Phone”	Make calls.
“USB”	Access the device connected to your USB port.
“Bluetooth Audio”	Stream audio from your phone.
“Line in”	Access the device connected to the auxiliary input jack.
“Cancel”	Cancel the requested action.
“SYNC”	Return to the main menu.
“Voice settings”	Adjust the level of voice interaction and feedback.
“Vehicle Health Report”	Run a vehicle health report.*
“Services”	Access the SYNC Services portal.*
“Mobile apps”	Access mobile applications.*
“Help”	Hear a list of voice commands available in the current mode.

*If equipped, U.S. only.

System Interaction and Feedback

The system provides feedback through audible tones, prompts, questions and spoken confirmations depending on the situation and the chosen level of interaction (voice settings). You can customize the voice recognition system to provide more or less instruction and feedback.

The default setting is to a higher level of interaction in order to help you learn to use the system. You can change these settings at any time.

Adjusting the Interaction Level



Push the voice icon; when prompted, say “Voice settings”, then any of the following:

When you say:	The system:
“Interaction mode standard”	Provides more detailed interaction and guidance.
“Interaction mode advanced”	Provides less audible interaction and more tone prompts.

The system defaults to the standard interaction mode.

Confirmation prompts are short questions the system asks when it is not sure of your request or when there are multiple possible responses to your request. (For example, the system may ask “Phone, is that correct?”) If turned off, the system simply makes a best guess as to what you requested and you may still occasionally be asked to confirm settings.

“Confirmation prompts on”
“Confirmation prompts off”

The system creates candidate lists when it has the same confidence level of several options based on your voice command. When turned on, you may be prompted with as many as four possibilities for clarification.

For example, “Say 1 after the tone to call John Doe at home. Say 2 after the tone to call Johnny Doe on mobile. Say 3 after the tone to call Jane Doe at home.” Or, “Say 1 after the tone to play John Doe, Say 2 after the tone to play Johnny Doe.”

“Phone candidate lists on”
“Phone candidate lists off”
“Media candidate lists on”
“Media candidate lists off”

Helpful Hints

- Make sure the interior of the vehicle is as quiet as possible. Wind noise from open windows and road vibrations may prevent the system from correctly recognizing spoken commands.
- After pressing the voice icon, wait until after the tone sounds and Listening appears before saying a command. Any command spoken prior to this does not register with the system.
- Speak naturally, without long pauses between words.
- At any time you can interrupt the system while it is speaking by pressing the voice icon.

USING SYNC WITH YOUR PHONE

Hands-free calling is one of the main features of SYNC. While the system supports a variety of features, many are dependent on your cellular phone's functionality. At a minimum, most cellular phones with Bluetooth wireless technology support the following functions:

- Answering an incoming call
- Ending a call
- Using privacy mode
- Dialing a number
- Redialing
- Call waiting notification
- Caller ID.

Other features, such as text messaging using Bluetooth and automatic phonebook download, are phone-dependent features. To check your phone's compatibility, see your phone's user manual and visit www.SYNCMYRide.com, www.SYNCMYRide.ca or www.syncmaroute.ca.

Pairing a Phone for the First Time

Note: SYNC can support downloading up to approximately 1000 entries per Bluetooth-enabled cellular phone.

Note: Make sure the vehicle ignition and radio are turned on and the transmission is in position **P**.

Note: To scroll through the menus, press the up and down arrows on your audio system.

Wirelessly pairing your phone with SYNC allows you to make and receive hands-free calls.

1. Press the phone button; when the display indicates no phone is paired, press **OK**.
2. When **Find SYNC** appears in the display, press **OK**.
3. Put your phone into Bluetooth discovery mode. See your phone's user guide if necessary.
4. When prompted on your phone's display, enter the six-digit PIN provided by SYNC in the radio display.
5. The display indicates when the pairing is successful.

Depending on your phone's capability and your market, the system may prompt you with questions such as setting the current phone as the primary phone (the phone SYNC automatically tries to connect with first upon vehicle start-up), downloading your phone book, etc.

Pairing Subsequent Phones

Note: To scroll through the menus, press the up and down arrows on your audio system.

Note: Make sure the vehicle ignition and radio are turned on and that the transmission is in position **P**.

1. Press the phone button and scroll until System Settings is selected.
2. Press OK and scroll until Bluetooth Devices is selected and press OK.
3. Scroll until Add Bluetooth Device is selected and press OK.
4. When Find SYNC appears in the display, press OK.
5. Put your phone into Bluetooth discovery mode. See your phone's user guide if necessary.
6. When prompted on your phone's display, enter the six-digit PIN provided by SYNC in the radio display. The display indicates when the pairing is successful.
7. The system then prompts with questions such as if you would like to set the current phone as the primary phone (the phone SYNC automatically tries to connect with first upon vehicle start-up), download your phone book, etc.

Phone Voice Commands



Press the voice icon and say "Phone". Say any of the following:

"PHONE"
"Call <name>" ^{1,2}
"Call <name> on mobile OR cell" ^{1,2}
"Call <name> on other" ^{1,2}
"Phone book <name> at home" ²
"Phone book <name> on mobile OR cell" ²
"Call history outgoing" ²
"Phone book <name> on Other" ²
"Call history missed" ²
"Menu" ^{2,3}
"Join"
"Call <name> at home" ^{1,2}
"Call <name> at work" OR "Call <name> in office" ^{1,2}
"Dial" ^{1,4}
"Phone book <name>" ²

“PHONE”
“Phone book <name> at work” OR “Phone book <name> at office” ²
“Call history incoming” ²
“Connections” ²
“Go to privacy”
“Hold”

¹These commands do not require you to say “Phone” first.

²These commands are not available until phone information is completely downloaded using Bluetooth.

³See “MENU” table below.

⁴See “DIAL” table below.

“MENU”
“(Phone) connections” [*]
“(Phone) settings (message) notification off” [*]
“(Phone) settings (message) notification on” [*]
“(Phone) settings (set) phone ringer” [*]
“(Phone) settings (set) ringer 1” [*]
“(Phone) settings (set) ringer 2” [*]
“(Phone) settings (set) ringer 3” [*]
“(Phone) settings (set) ringer off” [*]
“Battery”
“Phone name”
“Signal”
“Text message inbox”

^{*}Words in () are optional and do not have to be spoken for the system to understand the command.

Phone book commands: When you ask SYNC® to access a phone book name, number, etc., the requested information appears in the display to view. Press the phone button and say “Call” to call the contact.

“DIAL”
“411” (four-one-one), “911” (nine-one-one)
“700 (seven hundred)” (seven hundred)
“800 (eight hundred)” (eight hundred)
“900 (nine hundred)” (nine hundred)
“#” (pound)
“<number> 0–9”
“Asterisk” (*)
“Clear” (deletes all entered digits)
“Delete” (deletes one digit)
“Plus”
“Star”

Note: To exit dial mode, press and hold the phone button or press MENU to go to the PHONE menu.

Making Calls

Press the voice icon and when prompted say:

1. Say “Call <name>” or “Dial”, then the desired number.
2. When the system confirms the number, say “Dial” again to initiate the call.

To erase the last spoken digit, say “Delete” or press the left arrow button. To erase all spoken digits, say “Clear” or press and hold the left arrow button.

To end the call, press and hold the phone button.

Receiving Calls

When receiving a call, you can:

- Answer the call by pressing the phone button.
- Reject the call by pressing and holding the phone button.
- Ignore the call by doing nothing.

Phone Options during an Active Call

During an active call, you have additional menu features which become available such as putting a call on hold, joining calls, etc. Use the arrow buttons to scroll through the menu options.

To access:

1. Press MENU during an active call.
2. When Active Call Menu is selected, press OK.
3. Scroll to cycle through the following options:

When you select:	You can:
Mute Call?	Mute the call.
Privacy	Switch a call from an active hands-free environment to your cellular phone for a more private conversation. Press OK when Privacy on/off appears. (The display indicates In Privacy and the system transfers your call.)
Call Hold	Put an active call on hold. Press OK when Place Call on Hold? appears. To answer another call at this time, press the phone button.
Join Calls	Join two separate calls. <ol style="list-style-type: none"> 1. Press the phone button. 2. Access the desired contact through SYNC or use voice commands to place the second call. Once actively in the second call, press MENU. 3. Scroll until Join Calls appears and press OK. Press OK again when Join Calls? appears. Note: SYNC supports a maximum of three callers on a multiparty/conference call.
Enter Tones	Enter “tones” such as numbers for passwords. Scroll until the desired number appears in the display, then press OK; a tone sounds as confirmation. Repeat as necessary.
Phonebook	Access your phonebook contacts. <ol style="list-style-type: none"> 1. Press OK to select, then scroll through your phonebook contacts. 2. Press OK again when the desired selection appears in the display. 3. Press the phone button.

When you select:	You can:
Call History	Access your call history log. 1. Press OK to select, then scroll through your call history options (incoming, outgoing or missed). 2. Press OK when the desired selection appears in the display. 3. Press the phone button to call the selection.
Return	Exit the current menu.

Accessing Features through the Phone Menu

SYNC's phone menu allows you to redial a number, access your call history and phone book and send text messages as well as access phone and system settings. You can also access advanced features, such as 911 Assist, Vehicle Health Report and SYNC Services.

1. Press the phone button to enter the Phone Menu.
2. Scroll to cycle through:

When you select:	You can:
Phone Redial	Redial the last number called (if available). Press OK to select, then press OK again to confirm.
Call History¹	Allows you to access any previously dialed, received or missed calls while your phone has been connected to the system. 1. Press OK to select. 2. Scroll to select from Call History Incoming, Call History Outgoing or Call History Missed. Press OK make your selection. 3. Press OK or the phone button to call the desired selection. Note: The system attempts to automatically re-download your phone book and call history each time your phone connects to SYNC (if the auto download feature is on and your Bluetooth-enabled cellular phone supports this feature).

When you select:	You can:
Phonebook ^{1,2}	Allows you to access your downloaded phonebook. 1. Press OK to confirm and enter. If your phonebook has fewer than 255 listings, they appear alphabetically in flat file mode. If there are more, they are organized into alphabetical categories. 2. Scroll until the desired contact appears, then press OK. 3. Press OK or the phone button.
Text Message ¹	Enables you to send, download and delete text messages.
Phone Settings ¹	Allows you to view your phone's status, set ring tones, select your message notification, change phone book entries and automatically download your cellular phone among other features.
SYNC Services ³	Access the SYNC services portal where you can request various types of information, traffic reports and directions.
911 Assist ⁴	Place an emergency call to a 911 operator for you after an accident (if the feature is used properly).
Vehicle Health Report ³	Create and receive a diagnostic report card on your vehicle.
Mobile Apps ³	Interact with SYNC-capable mobile applications on your smartphone.
System Settings	Access Bluetooth Devices menu listings (add, connect, set as primary, on/off, delete) as well as Advanced menu listings (prompts, languages, defaults, master reset, install application and system information).
Exit Phone Menu	Exit the phone menu by pressing OK.

¹This is a phone-dependent feature.

²This is a phone-dependent and speed-dependent feature.

³If equipped, United States only.

⁴If equipped, United States and Canada only.

Text Messaging

Note: This is a phone-dependent feature.

SYNC allows you to receive, send, download and delete text messages. The system can also read incoming text messages to you so that you do not have to take your eyes off the road.

Receiving a Text Message

Note: This is a phone-dependent feature. Your phone must support downloading text messages using Bluetooth to receive incoming text messages.

Note: Forwarding a text message is a speed-dependent feature and can only be done when the vehicle is traveling at 3 mph (5 km/h) or less.

Note: Only one recipient is allowed per text message.

When a new message arrives, an audible tone sounds and the display indicates you have a new message. You have these options:

1. Press the voice button, wait for the prompt and say "Read Message" to have SYNC read the message to you.
2. Press OK to receive and open the text message or do nothing and the message goes into your text message inbox. Press OK again and SYNC reads your message aloud as you are not able to view the message. You can then also choose whether you'd like to reply or forward the message.
3. Press OK and scroll to choose between:
 - Reply to Text Message: Press OK to access and then scroll through the list of pre-defined messages to send.
 - Forward Text Message: Press OK to forward the message to anyone in your Phonebook or Call History. You can also choose Enter Number.

Sending, Downloading and Deleting Your Text Messages

Text messaging is a phone-dependent feature. If your phone is compatible, SYNC allows you to receive, send, download and delete text messages.

1. Press the phone button.
2. Scroll until Text Message appears and press OK.
3. Scroll to select from the following options:

Send Text Message? enables you to send a new text message based on a pre-defined set of 15 messages.

Download Unread Msgs allows you to download your unread messages (only) to SYNC. To download the messages, press OK to select. The display indicates your messages are being downloaded. When complete, SYNC takes you to your inbox.

Delete All Messages? allows you to delete current text messages from SYNC (not your phone). To delete the messages, press OK to select. The display indicates when all your text messages have been deleted and SYNC returns you to the text message menu.

Note: SYNC does not automatically download all of your unread text messages at every ignition cycle (as it does with call history and phonebook if automatic download is set to on).

Return exits the current menu when you press OK.

If you select **Send Text Message?**:

1. Press OK to select. If the system detects your phone does not support this feature, Unsupported appears in the display and SYNC returns to the main menu.
2. Scroll to cycle through the message options in the following chart.
3. Press OK when the desired selection is in the display. The system now needs to know who to send the message to.
4. Scroll to cycle through Phonebook or Call History entries. You can also select Enter Number to audibly enter a desired number.
5. Press OK to enter the desired menu and scroll to select the specific contact.
6. Press OK when the contact appears and press OK again to confirm when the system asks if you would like to send the message. Each text message is sent with the following signature: "This message was sent from my <Ford or Lincoln>".

Pre-defined text message options
Can't talk right now
Call me
Call you later
Be there in 10 minutes
Be there in 20 minutes
Yes
No
Why?
Thanks
Where R you?
I need more directions
I love you

Pre-defined text message options
Too funny
Can't wait to see you
I'm stuck in traffic

Accessing Your Phone Settings

These are phone-dependent features. Your phone settings allow you to access and adjust features such as your ring tone, text message notification, modify your phone book and also set up automatic download.

1. Press the phone button.
2. Scroll until Phone Settings appears, then press OK.
3. Scroll to select from the following options:

When you select:	You can:
Phone Status	See the provider, name, signal power, battery power and roaming status of your connected phone. Press OK to select and scroll to view the information. When done, press OK again to return to the phone status menu.
Set Ringer	Select which ring tone sounds during an incoming call (one of the system's or your phone's). 1. Press OK to select and scroll to hear Ringer 1, Ringer 2, Ringer 3 and Phone Ringer. 2. Press OK to select. Note: If your phone supports in-band ringing, your phone's ringer sounds when Phone Ringer is chosen.
Message Notification	Have the option of hearing an audible tone to notify you when a text message arrives. 1. Press OK to select and scroll between Message Notification On or Message Notification Off. 2. Press OK to select.

When you select:	You can:
Modify Phonebook	<p>Modify the contents of your phone book (i.e., add, delete, download). Press OK to select and scroll between:</p> <p>Add Contacts: Press OK to add more contacts from your phone book. Push the desired contact(s) on your phone. See your phone's user guide on how to push contacts.</p> <p>Delete Phonebook: Press OK to delete the current phone book and call history. When Delete Phonebook appears, press OK to confirm. SYNC takes you back to the Phone Settings menu.</p> <p>Download Phonebook: Press OK to select and press OK again when Confirm Download? appears.</p>
Auto Download	<p>Automatically download your phone book each time your phone connects to SYNC. Press OK to select. When Auto Download On? appears, press OK to have your phonebook automatically downloaded each time.</p> <p>Select Off to NOT download your phonebook every time your phone connects to SYNC. Your phonebook, call history and text messages can only be accessed when your specific phone is connected to SYNC.</p> <p>Note: Downloading times are phone- and quantity-dependent.</p> <p>Note: When auto download is on, any changes, additions or deletions saved since your last download are deleted.</p>
Return	Exit the current menu.

System Settings

System Settings provide access to your Bluetooth Devices and Advanced menu features. Use the arrow buttons to scroll through the menu options.

The Bluetooth Devices menu allows you to add, connect, delete and set a phone as primary as well as turn your Bluetooth feature on and off.

The Advanced menu allows you to access and set prompts, languages, defaults, perform a master reset, install an application and view system information.

Bluetooth Devices Menu Options

This menu allows you to add, connect, delete, set a phone as primary, and turn Bluetooth on or off.

1. Press the phone button to enter the Phone Menu.
2. Scroll until System Settings appears and press OK.
3. Scroll until Bluetooth Devices appears and select OK.
4. Scroll to select from the following options:

If you select:	You can:
Add Bluetooth Device*	See <i>Using SYNC with your phone</i> earlier in this chapter for pairing instructions.
Connect Bluetooth Device	Connect a previously paired Bluetooth-enabled phone. 1. Press OK to select and view a list of previously paired phones. 2. Scroll until the desired device is chosen, then press OK to connect the phone. Note: Only one device can be connected at a time. When another phone is connected, the previous one is disconnected.
Set Primary Phone	Set a previously paired phone as your primary phone. Press OK to select and scroll to select the desired phone. Press OK to confirm. Note: SYNC attempts to connect with the primary phone at every ignition cycle. When a phone is selected as primary, it appears first in the list and is marked with an asterisk (*).

If you select:	You can:
Set Bluetooth On/Off	Turn the Bluetooth feature on and off. Press OK and scroll to toggle between On and Off. When the desired selection is chosen, press OK. Note: Turning Bluetooth off disconnects all Bluetooth devices and deactivates all Bluetooth features.
Delete Device	Delete a paired phone. Press OK and scroll to select the device. Press OK to confirm.
Delete All Devices	Delete all previously paired phones (and all information originally saved with those phones). Press OK to select.
Return	Exit the current menu.

*This is a speed-dependent feature.

Advanced Menu Options

This menu allows you to access settings such as prompts, languages, defaults, perform a master reset, install an application and view system information.

1. Press the phone button to enter the Phone Menu.
2. Scroll until System Settings appears and press OK.
3. Scroll until Advanced appears and select OK.
4. Scroll to select from the following options:

If you select:	You can:
Prompts	Get help from SYNC by using questions, helpful hints or asking you for a specific action. To turn these prompts on or off: 1. Press OK to select and scroll to select between on or off. 2. Press OK when the desired selection appears in the display. SYNC takes you back to the Advanced menu.

If you select:	You can:
Languages	Choose between English, Espanol and Francais. Once selected, all of SYNC's radio displays and prompts are in the selected language. 1. Press OK to select and then scroll through the languages. 2. Press OK when the desired selection appears in the display. If you change the language setting, the display indicates that the system is updating. When complete, SYNC takes you back to the Advanced menu.
Factory Defaults	Return to the factory default settings. This selection does not erase your indexed information (phonebook, call history, text messages and paired devices). 1. Press OK to select and then press OK again when Restore Defaults? appears in the display. 2. Press OK to confirm.
Master Reset	Completely erase all information stored on SYNC (phonebook, call history, text messages and paired devices) and return to the factory default settings. Press OK to select. The display indicates when complete and SYNC takes you back to the Advanced menu.
Install Application	Install applications you have downloaded. Press OK and scroll to select. Press OK to confirm.
System Info	Access the Auto Version number as well as the FPN number. Press OK to select.
MAP Profile	This is a Bluetooth component which can further help your phone with the exchange of text messages.
Return	Exit the current menu.

SYNC APPLICATIONS AND SERVICES (IF EQUIPPED)

Note: In order for the following features to work, your cellular phone must be compatible with SYNC. To check your phone's compatibility, visit www.SYNCMYride.com, www.SYNCMYride.ca or www.syncmaroute.ca.

- SYNC Services (if equipped, United States only): Provides access to traffic, directions and information such as travel, horoscopes, stock prices and more.
- 911 Assist: Can alert 911 in the event of an emergency.
- Vehicle Health Report (if equipped, United States only): Provides a diagnostic and maintenance report card of your vehicle.
- SYNC AppLink: Allows you to connect to and use certain applications such as Pandora and Stitcher (if your phone is compatible).

911 Assist®

WARNING: Unless the 911 Assist setting is set on prior to a crash, the system will not dial for help which could delay response time, potentially increasing the risk of serious injury or death after a crash.



WARNING: Do not wait for 911 Assist to make an emergency call if you can do it yourself. Dial emergency services immediately to avoid delayed response time which could increase the risk of serious injury or death after a crash. If you do not hear 911 Assist within five seconds of the crash, the system or phone may be damaged or non-functional.



WARNING: Always place your phone in a secure location in the vehicle so it does not become a projectile or get damaged in a crash. Failure to do so may cause serious injury to someone or damage the phone which could prevent 911 Assist from working properly.

Note: SYNC 911 Assist feature must be set on prior to the incident.

Note: Before setting this feature on, ensure that you read the 911 Assist privacy notice later in this section for important information.

Note: If 911 Assist is turned on or off by any user, that setting applies for all paired phones. If 911 Assist is turned off, a voice message plays and/or a display message/icon comes on when the vehicle is started after a previously paired phone connects.

Note: Every phone operates differently. While SYNC 911 Assist works with most cellular phones, some may have trouble using this feature.

If a crash deploys an airbag (excludes knee airbags and rear inflatable safety belts [if equipped]) or activates the fuel pump shut-off, your SYNC equipped vehicle may be able to contact emergency services by dialing 911 through a paired and connected Bluetooth-enabled phone. For more information about 911 Assist, visit www.SYNCMYride.com, www.SYNCMYride.ca or www.syncmaroute.ca.

- For information on airbag deployment, see the *Supplementary Restraints System* chapter.
- For information on the fuel pump shut-off, see the *Roadside Emergencies* chapter.

Setting 911 Assist On

Perform the following:

1. Press the phone button to enter the Phone Menu.
2. Scroll until 911 Assist is selected.
3. Press OK to confirm and enter the 911 Assist menu.
4. Scroll to select between On and Off selections.
5. Press OK when the desired option appears in the radio display. Set On or Set Off appears in the display as confirmation.

Off selections include: Off with reminder and Off without reminder. Off with reminder provides a display and voice reminder at phone connection at vehicle start. Off without reminder provides a display reminder only without a voice reminder at phone connection.

To make sure that 911 Assist works properly:

- SYNC must be powered and working properly at the time of the incident and throughout feature activation and use.
- SYNC 911 Assist feature must be set on prior to the incident.
- A Bluetooth-enabled and compatible phone has to be paired and connected to SYNC.
- A connected Bluetooth-enabled phone must have the ability to make and maintain an outgoing call at the time of the incident.
- A connected Bluetooth-enabled phone must have adequate network coverage, battery power and signal strength.
- The vehicle must have battery power and be located in the United States, Canada or in a territory in which 911 is the emergency number.

In the Event of a Crash

Not all crashes deploy an airbag or activate the fuel pump shut-off (which would activate 911 Assist); however, if 911 Assist is triggered, SYNC tries to contact emergency services. If a connected phone is damaged or loses connection to SYNC, SYNC searches for, and tries to connect to, any available previously paired phone and tries to make the call to 911.

Before making the call:

- SYNC provides a short window of time (about 10 seconds) to cancel the call. Failure to cancel the call results in SYNC attempting to dial 911.
- SYNC says the following, or a similar message: “SYNC will attempt to call 911, to cancel the call, press Cancel on your screen or press and hold the phone button on your steering wheel.”

If the call is not cancelled and a successful call is made, a pre-recorded message is played for the 911 operator, then the occupant(s) in the vehicle is able to talk with the operator. Be prepared to provide your name, phone number and location immediately, because not all 911 systems are capable of receiving this information electronically.

911 Assist May Not Work If

- Your cellular phone or 911 Assist hardware was damaged in a crash.
- The vehicle’s battery or SYNC system has no power.
- The phone(s) paired and connected to the system was thrown from the vehicle.

911 Assist Privacy Notice

Once 911 Assist is set on, it may disclose to emergency services that the vehicle has been in a crash involving the deployment of an airbag or activation of the fuel pump shut-off. Certain versions or updates to 911 Assist may also be capable of electronically or verbally disclosing to 911 operators the vehicle location, and/or other details about the vehicle or crash to assist 911 operators to provide the most appropriate emergency services. If you do not want to disclose this information, do not turn the feature on.

Vehicle Health Report



WARNING: Always follow scheduled maintenance instructions, regularly inspect your vehicle, and seek repair for any damage or problem you suspect. Vehicle Health Report supplements, but cannot replace normal maintenance and vehicle inspection. Vehicle Health Report only monitors certain systems that are electronically monitored by the vehicle and will not monitor or report the status of any other system, (i.e., brake lining wear). Failure to perform scheduled maintenance and regularly inspect your vehicle may result in vehicle damage and serious injury.

Note: Your Vehicle Health Report feature requires activation prior to use. Visit www.SYNCMYride.com to register. There is no fee or subscription associated with Vehicle Health Report, but you must register to use this feature.

Note: This feature may not function properly if you have enabled caller ID blocking on your mobile phone. Before running a report, review the *Vehicle Health Report privacy notice*.

Note: In order to allow a break-in period for your vehicle, you may not be able to create a Vehicle Health Report until your vehicle odometer has reached 200 miles.

Register for Vehicle Health Report and set your report preferences at www.SYNCMYride.com. After registering, you can request a Vehicle Health Report (inside your vehicle). Return to your account at www.SYNCMYride.com to view your report. You can also choose for SYNC to automatically remind you to run reports at specific mileage intervals. Cellular phone airtime usage may apply when reporting.

The system allows you to check your vehicle's overall health in the form of a diagnostic report card. The vehicle health report contains valuable information such as:

- Vehicle Diagnostic Information
- Scheduled maintenance
- Open Recalls and Field Service Actions
- Unserviced items from vehicle inspections by your authorized dealer.

You can run a report (after the vehicle has been running a minimum of 60 seconds) by pressing the voice button and saying "Vehicle health report", or pressing the phone button.

To run a report using the phone button:

1. Press the phone button to enter Phone Menu.
2. Scroll until Vehicle Health is selected and press OK.
3. Scroll to select from the following options:

Vehicle Health Report options	
User Preferences: Press OK to select and enter the menu. Scroll to select from:	<p>Automatic Reports: Press OK and select on or off. Select On to have SYNC automatically prompt you to run a health report at certain mileage intervals. Note: You must first turn this feature on before you can select the mileage intervals at which you would like to be prompted.</p> <p>Mileage Intervals: Press OK. Scroll to select between 5000, 7500 or 10000 mile intervals and press OK to make your selection.</p> <p>Return: Press OK to exit the menu.</p>
Run Report?	Press OK for SYNC to run a health report of your vehicle's diagnostic systems and send the results to Ford where it is combined with scheduled maintenance information, open recalls and other field service actions and unserviced vehicle inspection items from your authorized dealer.

Vehicle Health Report Privacy Notice

When you run a Vehicle Health Report, Ford Motor Company may collect your cellular phone number (to process your report request) and diagnostic information about your vehicle. Certain versions or updates to Vehicle Health Report may also collect additional vehicle information. Ford may use the vehicle information it collects for any purpose. If you do not want to disclose your cellular phone number or vehicle information, do not run the feature or set up your Vehicle Health Report profile at www.SYNCMYride.com. See www.SYNCMYride.com - Vehicle Health Report Terms and Conditions, and Privacy Statement - for more information.

SYNC Services: Traffic, Directions & Information (TDI)

Note: SYNC Services requires activation prior to use. Visit www.SYNCMYRide.com to register and check your eligibility for complimentary services. Standard phone and message rates may apply. Subscription may be required. You must also have the active SYNC Services Bluetooth-enabled cellular phone paired and connected to the system in order to connect to, and use, SYNC Services. See *Using SYNC with your phone* for pairing instructions.

Note: This feature does not function properly if you have enabled caller ID blocking on your mobile phone. Make sure your mobile phone is not blocking caller ID before using SYNC Services.

Note: The driver is ultimately responsible for the safe operation of the vehicle, and therefore, must evaluate whether it is safe to follow the suggested directions. Any navigation features are provided only as an aid. Make your driving decisions based on your observations of local conditions and existing traffic regulations. Do not follow the route suggestions if doing so would result in an unsafe or illegal maneuver, if you would be placed in an unsafe situation, or if you would be directed into an area that you consider unsafe. Maps used by this system may be inaccurate because of errors, changes in roads, traffic conditions or driving conditions.

Note: When you connect, the service uses GPS technology and advanced vehicle sensors to collect the vehicle's current location, travel direction and speed to help provide you with the directions, traffic reports, or business searches you request. Further, to provide the services you request and for continuous improvement, the service may collect and record call details and voice communications. For more information, see SYNC Services Terms and Conditions at www.SYNCMYRide.com. If you do not want Ford or its service providers to collect the vehicle travel information or other information identified in the Terms and Conditions, do not activate or use the service.

SYNC Services uses advanced vehicle sensors, integrated GPS technology and comprehensive map and traffic data, to give you personalized traffic reports, precise turn-by-turn directions, business search, news, sports, weather and more. For a complete list of services, or to learn more, please visit www.SYNCMYRide.com.

Connecting to SYNC Services Using Voice Commands

1. Press the voice button.
2. When prompted, say "Services". This initiates an outgoing call to SYNC Services using your paired and connected Bluetooth-enabled cellular phone.

3. Once you are connected to the service, follow the voice prompts to request the desired service, such as “Traffic” or “Directions”. You can also say “What are my choices?” to receive a complete list of available services from which to choose.
4. Say “Services” to return to the services main menu or for help, say “Help”.

Connecting to SYNC Services Using the Phone Menu

1. Press the phone button to enter the Phone Menu.
2. Scroll until *Services* appears in the display.
3. Press OK to confirm and enter the Services menu. The display indicates the system is connecting.
4. Press OK. SYNC initiates the call to the Services portal.
5. Once connected, follow the voice prompts to request your desired Service, such as Traffic or Directions. You can also say “What are my choices?” to receive a complete list of available services from which to choose.
6. To return to the Services menu, say “Services” or for help, say “Help”.

Receiving Turn-by-Turn Directions

1. When connected to SYNC Services, say “Directions” or “Business search”. To find the closest business or type of business to your current location, just say “Business search” and then “Search near me”. If you need further assistance in finding a location you can say “Operator” at any time within a Directions or Business search to speak with a live operator. You may also be prompted to speak with an operator when the automatic system has difficulty matching your voice request. The live operator can assist you by searching for businesses by name or by category, residential addresses by street address or by name or specific street intersections. Operator Assist is a feature of your SYNC Services subscription. For more information on Operator Assist visit www.SYNCMYRide.com/support.
2. Follow the voice prompts to select your destination. Once your destination is selected, your current vehicle location is uploaded and a route based on current traffic conditions is calculated and sent back to your vehicle. After the route download is complete, the phone call is automatically ended. You then receive audible and visual driving instructions as you travel toward your destination.
3. While on an active route, you can select or say “Route summary” or “Route status” to view the Route Summary turn list or the Route Status ETA. You can also turn voice guidance on or off, cancel the route or update the route.

If you miss a turn, SYNC automatically asks if you want the route updated. Just say, “Yes” when prompted and a new route will be delivered to your vehicle.

Disconnecting from SYNC Services

1. Press and hold the phone button on the steering wheel.
2. Say “Good-bye” from the SYNC Services main menu.

SYNC Services quick tips	
Personalizing	You can personalize your Services feature to provide quicker access to your most used or favorite information. You can save address points such as work or home. You can also save favorite information like sports teams or a news category. To learn more, log onto www.SYNCMYRide.com .
Push to interrupt	Press the voice button at any time (while you are connected to SYNC TDI Services) to interrupt a voice prompt or an audio clip (such as a sports report), wait for the listening tone, and say your voice command.
Portable	Your subscription is associated with your Bluetooth-enabled cellular phone number, not your VIN (Vehicle Identification Number). You can pair and connect your phone to any vehicle equipped with Traffic, Directions and Information and continue enjoying your personalized services. You can even access your account outside the vehicle. Just use the number on your phone’s call history. Traffic and Directions features do not function properly but information services and the 411 connect and text message features are available.

SYNC AppLink™

Note: This feature is only available in the United States.

Note: Your smartphone must be paired and connected to SYNC to access AppLink.

Note: iPhone users need to connect the phone to the USB port in order to start the application. It is recommended to lock your iPhone after starting an application.

Note: The AppLink feature is not available if your vehicle is equipped with the MyFord Touch or MyLincoln Touch system.

Depending on your display type, you can access AppLink from the media menu, the phone menu, or by using voice commands. Once an app is running through AppLink, you can control main features of the app through voice commands and steering wheel controls.

To Access Using the Phone Menu

1. Press the phone button to access the SYNC phone menu on-screen.
2. Scroll to Mobile Apps and press **OK** to access a list of available applications.
3. Scroll through the list of available applications and press **OK** to select a particular app.
4. Once an app is running through SYNC, you can access an app's menu by pressing the **MENU** button to first access the SYNC menu.
5. Select "SYNC-Media" by pressing **OK**.
6. Scroll until "<App name> Menu" is displayed (such as Pandora Menu), then press **OK**. From here, you can access an application's features, such as Thumbs up, Thumbs down, etc. For more information, please visit www.SYNCMyRide.com.

To Access Using the Media Menu

1. Press **AUX** button on the center console.
2. Press **MENU** to access the SYNC menu.
3. Select "SYNC-Media" by pressing **OK**.
4. Then scroll to Mobile Apps and press **OK** to access a list of available applications.
5. Scroll through the list of available applications and press **OK** to select a particular app.
6. Once an app is running through SYNC, you can access an app's menu by pressing the **MENU** button to first access the SYNC menu.
7. Select "SYNC-Media" by pressing **OK**.
8. Scroll until "<App name> Menu" is displayed (such as Pandora Menu), then press **OK**. From here, you can access an application's features, such as Thumbs up, Thumbs down, etc. For more information, please visit www.SYNCMyRide.com.

To Access Using Voice Commands

1. Press the voice icon.
2. When prompted, say “Mobile Apps”.
3. Say the name of the application after the tone.
4. The app should start. While an app is running through SYNC, you can press the voice button and speak commands specific to the app, such as “Play Station Quickmix”. Say “Help” to discover available voice commands.

USING SYNC WITH YOUR MEDIA PLAYER

You can access and play music from your digital music player over the vehicle's speaker system using the system's media menu or voice commands. You can also sort and play your music by specific categories, such as artists, albums, etc.

SYNC is capable of hosting nearly any digital media player including: iPod, Zune™, Plays from device players, and most USB drives. SYNC also supports audio formats such as MP3, WMA, WAV and ACC.

Connecting Your Digital Media Player via the USB Port

Note: If your digital media player has a power switch, ensure that the device is turned on.

To connect using voice commands:

1. Plug the device into the vehicle's USB port.
2. Press the voice icon and when prompted, say “USB”.
3. You can now play music by saying any of the appropriate voice commands. See the media voice commands.

To connect using the system menu:

1. Plug the device into the vehicle's USB port.
2. Press AUX and then MENU to enter the Media Menu.
3. Scroll until Select Source appears and press OK.
4. Scroll to select USB and press OK.
5. Depending on how many digital media files are on your connected device, Indexing may appear in the radio display. When indexing is complete, the screen returns to the Play Menu.

6. Press OK and scroll through selections of:

- Play All
- Artists
- Albums
- Genres
- Playlists
- Tracks
- Explore USB
- Similar Music
- Return

When the desired selection appears in the display, press OK to build your desired music selection.

What's Playing?



At any time when a track is playing, you can press the voice icon and ask the system, "What's playing?". The system reads the metadata tags (if populated) of the playing track to you.

Media Voice Commands



Press the voice icon and, when prompted, say "USB" then any of the following:

"USB"
"Autoplay off"
"Autoplay on"
"(Phone) (Media) (Bluetooth) Connections"
"Pause"
"Play"
"Play album <name>" ^{1,3}
"Play all"
"Play artist <name>" ^{1,3}
"Play genre <name>" ^{1,3}
"Play next folder" ²
"Play next track"
"Play playlist <name>" ^{1,3}
"Play previous folder" ²
"Play previous track"
"Play song <name>" ^{1,3}

“USB”
“Play track <name>” ^{1,3}
“Refine album <name>” ^{1,3}
“Refine artist <name>” ^{1,3}
“Refine song <name>” ^{1,3}
“Refine track <name>” ^{1,3}
“Repeat off”
“Repeat on”
“Search album <name>” ^{1,3}
“Search artist <name>” ^{1,3}
“Search genre <name>” ^{1,3}
“Search song <name>” ^{1,3}
“Search track <name>” ^{1,3}
“Shuffle off”
“Shuffle on”
“Similar music”
“What’s playing?”

¹“<name>” is a dynamic listing, meaning that it could be the name of any desired group, artist, etc.

²Voice commands which are only available in folder mode.

³Voice commands which are not available until indexing is complete.

Voice command guide	
“Autoplay”	Turn on to listen to music which has already been randomly indexed during the indexing process. Turn off and the system does not begin to play any of your music until all media has all been indexed. Indexing times can vary from device to device and also with regard to the number of songs being indexed.
“Search/Play Genre”	The system searches all the data from your indexed music and, if available, begins to play the chosen type of music. You can only play genres of music which are present in the GENRE metadata tags that you have on your digital media player.

Voice command guide	
“Similar Music”	The system compiles a playlist and then plays similar music to what is currently playing from the USB port using indexed metadata information.
“Search/Play Artist/Track/Album”	The system searches for a specific artist/track/album from the music indexed through the USB port.
“Refine”	This allows you to make your previous command more specific. For example, if you asked to search and play all music by a certain artist, you could then say “refine album” and choose a specific album from the list to view. If you then select Play, the system only plays music from that specific album.

Press the voice icon and when prompted say “Bluetooth Audio” and then any of the following:

“BLUETOOTH AUDIO”
“(Phone) (Media) (Bluetooth) Connections”
“Pause”
“Play”
“Play next track ”
“Play previous track ”

Media Menu Features

The media menu allows you to select your media source, how to play your music (by artist, genre, shuffle, repeat, etc.), and also to add, connect or delete devices.

1. Press AUX and then MENU to enter the Media Menu.
2. Scroll to cycle through:

When you select:	You can:
Play Menu	Play your music by artist, album, genre, playlists, tracks, similar music or to simply, play all. You can also choose to Explore USB to view the supported digital music files on your playing device. See Play Menu later in this section for more information.

When you select:	You can:
<p>Select Source</p>	<p>SYNC USB: Press OK to access music plugged into your USB port. You can also plug in devices to charge them (if supported by your device). Once connected, the system indexes any readable media files. (The time required to complete this depends on the size of the media content being indexed.) If Autoplay is on, you can access media files randomly as they are indexed. If turned off, indexed media is not available until the indexing process is complete. SYNC is capable of indexing thousands of average size media and notifies you if the maximum indexing file size is reached.</p>
	<p>Bluetooth Audio: This is a phone-dependent feature which allows you to stream music playing on your Bluetooth-enabled phone. If supported by your device, you can press SEEK to play the previous or next track.</p>
	<p>SYNC Line In: Press OK to select and play music from your portable music player over the vehicle's speakers. Note: If you have already connected a device to the USB port, you cannot access the line in feature. Some digital media players require both USB and line in ports to stream data and music separately.</p>

When you select:	You can:
Media Settings	<p>Choose to shuffle or repeat your music and select your Autoplay settings. Once these selections are turned on, they remain on until turned off. Press SEEK to play the previous or next track.</p> <p>Note: Some digital media players require both USB and line in ports to stream data and music separately. Press OK to select and then scroll to choose from:</p> <p>Shuffle: Press OK to shuffle available media files in the current playlist. Note: To shuffle all media tracks, you must select Play All in the Play Menu and then select Shuffle.</p> <p>Repeat: Press OK to repeat any song.</p> <p>Autoplay: Press OK to listen to music which has already been randomly indexed during the indexing process.</p>
Mobile Apps	Interact with SYNC-capable mobile applications on your smart phone. See <i>SYNC AppLink</i> earlier in this chapter for more information.
System Settings	<p>Access Bluetooth Device menu listings (add, connect, set as primary, on/off, delete) as well as Advanced menu listings (prompts, languages, defaults, master reset, install application and system information).</p> <p>Note: See System Settings for more information.</p>
Exit Media Menu	Press OK to exit the media menu.

Accessing Your Play Menu

This menu allows you to select and play your media by artist, album, genre, playlist, track, similar music or even to explore what is on your USB device.

1. Make sure that your device is plugged into the USB port and is turned on.
2. Press AUX and then MENU to enter the Media Menu.
3. Scroll to select the Play Menu and press OK.

If there are no media files to access, the display indicates there is no media. If there are media files, you have the following options to scroll through and select from:

When you select:	You can:
Play All	Play all indexed media (tracks) from your playing device in flat file mode, one at a time in numerical order. Press OK to select. The first track title appears in the display.
Artists	Sort all indexed media by artist. Once selected, the system lists and then play all artists and tracks alphabetically. If there are less than 255 indexed artist, they are listed alphabetically in flat file mode. If there are more, they are categorized in alphabetical categories. 1. Press OK to select. You can select to play All Artists or any indexed artist. 2. Scroll until the desired artist is chosen and press OK.

When you select:	You can:
Albums	<p>Sort all indexed media by albums. If there are less than 255 indexed albums, they are listed alphabetically in flat file mode. If there are more, they are organized into alphabetical categories.</p> <ol style="list-style-type: none"> 1. Press OK to enter the album menu and select from playing all albums or from any individual indexed album. 2. Scroll until the desired album is chosen and press OK.
Genres	<p>Sort indexed music by genre (category) type. SYNC lists the genres alphabetically in flat file mode. If there are more than 255, SYNC automatically organizes them into alphabetical categories.</p> <p>Press OK to select and then scroll to select the desired genre and press OK.</p>
Playlists	<p>Access your playlists (from formats such as ASX, .M3U, .WPL, .MTP.). The system lists your playlists alphabetically in flat file mode. If there are more than 255, they are organized into alphabetical categories.</p> <p>Press OK to select. Then scroll to select the desired playlist and press OK.</p>
Tracks	<p>Search for and play a specific track which has been indexed. SYNC lists your tracks alphabetically in flat file mode. If there are more than 255, SYNC automatically organizes them into alphabetical categories.</p> <p>Press OK to select. Then scroll to select the desired track and press OK.</p>

When you select:	You can:
Explore USB	Explore all supported digital media on your media device connected to the USB port. You can only view media content which is compatible with SYNC; other files saved are not visible. Press OK to select. Then scroll to explore indexed media on your flash drive.
Similar Music	Play music similar to what is currently playing from the USB port. The system uses the metadata information of each song to compile a playlist for you. Press OK to select. The system creates a new list of similar songs and begins playing. The metadata tags must be populated for this feature to include each track. Note: With certain playing devices, if your metadata tags are not populated, the tracks won't be available in voice recognition, play menu or similar music. However, if you place these tracks onto your playing device in "Mass Storage Device Mode", they are available in voice recognition, play menu browsing and similar music. Unknowns are placed into any unpopulated metadata tag.
Return	Exit the current menu.

System Settings

System settings provide access to your Bluetooth Devices and Advanced menu features.

The Bluetooth Devices menu allows you to add, connect and delete a device as turn the Bluetooth feature on and off.

Your Advanced menu allows you to access and set prompts, languages, defaults and perform a master reset.

Bluetooth Devices Menu Options

This menu allows you to add, connect and delete devices as well as turn Bluetooth on and off.

1. Press AUX and then MENU to enter the Media Menu.
2. Scroll until System Settings appears and select OK.
3. Scroll until Bluetooth Devices appears.
4. Press OK and then scroll to select from:

When you select:	You can:
Add Bluetooth Device*	Allows you to pair additional devices to the system. 1. Press OK to select and press OK again when Find SYNC appears in the display. 2. Follow the directions in your phone's user guide to put your phone into discovery mode. A six-digit PIN appears in the display. 3. When prompted on your phone's six-digit display, enter the PIN.
Connect Bluetooth Device	Connect a previously paired Bluetooth-enabled phone. 1. Press OK to select and view a list of devices. 2. Scroll until the desired device is chosen and press OK to connect the device.
Set Bluetooth On/Off	Turn the Bluetooth feature on and off. Press OK and scroll to toggle between On and Off. When the desired selection is chosen, press OK. Turning Bluetooth off disconnects all Bluetooth devices and deactivates Bluetooth features.
Delete Device	Delete a paired media device. Press OK and scroll to select the device. Press OK to confirm.
Delete All Devices	Delete all previously paired devices. Press OK to select.
Return	Exit the current menu.

*This is a speed-dependent feature

Advanced Menu Options

This menu allows you to access settings such as prompts, language, performing a master reset as well as returning to factory defaults.

1. Press AUX and then MENU to access the Media Menu.
2. Scroll until System Settings appears and select OK.
3. Scroll until Advanced appears.
4. Press OK and then scroll to select from the following:

When you select:	You can:
Prompts	Have SYNC guide you via questions, helpful hints or ask you for a specific action. <ol style="list-style-type: none"> 1. Press OK to select and scroll to select between on or off. 2. Press OK when the desired selection appears in the display. SYNC takes you back to the Advanced menu.
Languages	Choose from English, Francais and Espanol. The displays and prompts are in the selected language. <ol style="list-style-type: none"> 1. Press OK to select and then scroll through the languages. 2. Press OK when the desired selection appears in the display. 3. If you change the language setting, the display indicates that the system is updating. When complete, SYNC takes you back to the Advanced menu.
Factory Defaults	Return to the factory default settings. This selection does not erase your indexed information (phonebook, call history, text messages and paired devices). <ol style="list-style-type: none"> 1. Press OK to select and then press OK again when Restore Defaults? appears in the display. 2. Press OK to confirm.
Master Reset	Completely erase all information stored on SYNC (all phonebook, call history, text messages and all paired devices) and return to the factory default settings.

When you select:	You can:
Application	Download new software applications (if available) and then load the desired applications through your USB port. See the web site for more information.
Return	Exit the current menu.

TROUBLESHOOTING

Your SYNC system is easy to use. However, should questions arise, see the tables below.

Use the website at any time to check your phone's compatibility, register your account and set preferences as well as access a customer representative via an online chat (during certain hours). Visit www.SYNCMYride.com, www.SYNCMYride.ca or www.syncmaroute.ca for more information.

Phone issues		
Issue	Possible cause(s)	Possible solution(s)
Excessive background noise during a phone call.	The audio control settings on your phone may be affecting SYNC performance.	Review your phone's user guide regarding audio adjustments.
During a call, I can hear the other person but they cannot hear me.	Possible phone malfunction.	Try turning off the device, resetting the device, removing the device's battery, then trying again.
SYNC is not able to download my phonebook.	<ul style="list-style-type: none"> • This is a phone-dependent feature, OR • Possible phone malfunction. 	<ul style="list-style-type: none"> • Go to the website to review your phone's compatibility. • Try turning off the device, resetting the device or removing the device's battery, then trying again. • Try pushing your phonebook contacts to SYNC by using the Add Contacts feature. • Use the SYNCmyphone feature available on the website.

Phone issues		
Issue	Possible cause(s)	Possible solution(s)
The system says Phonebook Downloaded but my phonebook in SYNC is empty or is missing contacts.	Limitations on your phone's capability.	<ul style="list-style-type: none"> • Try pushing your phonebook contacts to SYNC by using the Add Contacts feature. • If the missing contacts are stored on your SIM card, try moving them to the device memory. • Remove any pictures or special ring tones associated with the missing contact.
I am having trouble connecting my phone to SYNC.	<ul style="list-style-type: none"> • This is a phone-dependent feature, OR • Possible phone malfunction. 	<ul style="list-style-type: none"> • Go to the website to review your phone's compatibility. • Try turning off the device, resetting the device or removing the device's battery, then trying again. • Try deleting your device from SYNC, deleting SYNC from your device and trying again. • Check the security and auto accept/prompt always settings relative to the SYNC Bluetooth connection on your phone. • Update your device's software firmware. • Turn off the Auto phonebook download setting.
Text messaging is not working on SYNC.	<ul style="list-style-type: none"> • This is a phone-dependent feature, OR • Possible phone malfunction. 	<ul style="list-style-type: none"> • Go to the website to review your phone's compatibility. • Try turning off the device, resetting the device or removing the device's battery, then trying again.

USB and media issues		
Issue	Possible cause(s)	Possible solution(s)
I am having trouble connecting my device.	Possible device malfunction.	<ul style="list-style-type: none"> • Try turning off the device, resetting the device or removing the device's battery, then trying again. • Make sure you are using the manufacturer's cable. • Make sure the USB cable is properly inserted into the device and the vehicle's USB port. • Make sure that the device does not have an auto-install program or active security settings.
SYNC does not recognize my device when I turn on the car.	This is a device limitation.	Make sure you are not leaving the device in your vehicle during very hot or cold temperatures.
Bluetooth audio does not stream.	<ul style="list-style-type: none"> • This is a phone-dependent feature, OR • The device is not connected. 	Make sure the device is connected to SYNC and that you have pressed play on your device.
SYNC does not recognize music that is on my device.	<ul style="list-style-type: none"> • Your music files may not contain the proper artist, song title, album or genre information, OR • The file may be corrupted, OR • The song may have copyright protection which does not allow it to play. 	<ul style="list-style-type: none"> • Make sure that all song details are populated. • Some devices require you to change the USB settings from mass storage to MTP class.

Vehicle Health Report and SYNC Services (Traffic, Directions and Information) issues		
Issue	Possible cause(s)	Possible solution(s)
I received a text that the Vehicle Health Report is not activated.	<ul style="list-style-type: none"> Your account may not be activated on the website, OR You may have the wrong VIN (vehicle identification number) listed. 	<ul style="list-style-type: none"> This is a free feature, but you must first register online to use it. Make sure that your VIN is correctly listed in your account.
I am unable to retrieve the report on the website, or I receive a system error.	The preferred dealer information did not load correctly.	When you register your account, you must list a preferred dealer. If one is already listed, try selecting another dealer and logging out. Log back in and change it back to your preferred dealer and retrieve the report.
I am unable to submit a report.	<ul style="list-style-type: none"> This could be due to your phone's compatibility, OR Bad signal strength, OR Your phone may not be activated on the website. 	<ul style="list-style-type: none"> Update your mobile number in your account on the website. Make sure you have full signal strength and that your <i>Bluetooth</i> volume level has been turned up. Try deleting your phone and performing a clean pairing.
I heard a commercial when I tried to use Traffic, Directions and Information.	<ul style="list-style-type: none"> The phone in use is not activated, OR Your phone has ID blocker active. 	<ul style="list-style-type: none"> This is a free feature, but you must first register online to use it. Turn off ID blocker on your phone as the system recognizes you by your phone number. Make sure the currently connected phone is the same one that is registered on your SyncMyRide account.

Voice command issues		
Issue	Possible cause(s)	Possible solution(s)
SYNC does not understand what I am saying.	<ul style="list-style-type: none"> • You may be using the wrong voice commands, OR • You may be speaking too soon or at the wrong time. 	<ul style="list-style-type: none"> • Review the Phone voice commands and the Media voice commands at the beginning of their respective sections. • Be aware that SYNC's microphone is either in your rear view mirror or in the headliner just above the windshield.
SYNC does not understand the name of a song or artist.	<ul style="list-style-type: none"> • You may be using the wrong voice commands, OR • You may not be saying the name exactly as it is saved, OR • The system may not be reading the name the same way you are saying it. 	<ul style="list-style-type: none"> • Review the media voice commands at the beginning of the media section. • Say the song or artist exactly as listed. If you say, "Play Artist Prince", the system does not play music by Prince and the Revolution or Prince and the New Power Generation. • Make sure you are saying the complete title, such as "California remix featuring Jennifer Nettles". • If the songs are saved in all CAPS, you have to spell them. LOLA requires you to say, "Play L-O-L-A". • Do not use special characters in the title as the system does not recognize them.

Voice command issues		
Issue	Possible cause(s)	Possible solution(s)
<p>SYNC does not understand or is calling the wrong contact when I want to make a call.</p>	<ul style="list-style-type: none"> • You may be using the wrong voice commands, OR • You may not be saying the name exactly as it is saved, OR • Contacts in your phonebook may be very short and similar, or they may contain special characters, OR • Your phonebook contacts may be saved in CAPS. 	<ul style="list-style-type: none"> • Review the phone voice commands at the beginning of the phone section. • Make sure you are saying the contacts exactly as listed. For example, if a contact is saved as Joe Wilson, say “Call Joe Wilson”. • The system works better if you list full names, such as “Joe Wilson” rather than “Joe”. • Do not use special characters such as 123 or ICE, as the system does not recognize them. • If contacts are saved in CAPS, you have to spell them. JAKE requires you to say, “Call J-A-K-E”.

GENERAL INFORMATION**SYNC® End User License Agreement (EULA)**

- You have acquired a device (“DEVICE”) that includes software licensed by Ford Motor Company and its affiliates (“FORD MOTOR COMPANY”) from an affiliate of Microsoft Corporation (“MS”). Those installed software products of MS origin, as well as associated media, printed materials, and “online” or electronic documentation (“MS SOFTWARE”) are protected by international intellectual property laws and treaties. The MS SOFTWARE is licensed, not sold. All rights reserved.
- The MS SOFTWARE may interface with and/or communicate with, or may be later upgraded to interface with and/or communicate with additional software and/or systems provided by FORD MOTOR COMPANY. The additional software and systems of FORD MOTOR COMPANY origin, as well as associated media, printed materials, and “online” or electronic documentation (“FORD SOFTWARE”) are protected by international intellectual property laws and treaties. The FORD SOFTWARE is licensed, not sold. All rights reserved.
- The MS SOFTWARE and/or FORD SOFTWARE may interface with and/or communicate with, or may be later upgraded to interface with and/or communicate with additional software and/or systems provided by third party software and service suppliers. The additional software and services of third party origin, as well as associated media, printed materials, and “online” or electronic documentation (“THIRD PARTY SOFTWARE”) are protected by international intellectual property laws and treaties. The THIRD PARTY SOFTWARE is licensed, not sold. All rights reserved.
- The MS SOFTWARE, FORD SOFTWARE and THIRD PARTY SOFTWARE hereinafter collectively and individually will be referred to as “SOFTWARE.”

IF YOU DO NOT AGREE TO THIS END USER LICENSE AGREEMENT (“EULA”), DO NOT USE THE DEVICE OR COPY THE SOFTWARE. ANY USE OF THE SOFTWARE, INCLUDING BUT NOT LIMITED TO USE ON THE DEVICE, WILL CONSTITUTE YOUR AGREEMENT TO THIS EULA (OR RATIFICATION OF ANY PREVIOUS CONSENT).

GRANT OF SOFTWARE LICENSE: This EULA grants you the following license:

- You may use the SOFTWARE as installed on the DEVICE and as otherwise interfacing with systems and/or services provide by or through FORD MOTOR COMPANY or its third party software and service providers.

DESCRIPTION OF OTHER RIGHTS AND LIMITATIONS:

- **Speech Recognition:** If the SOFTWARE includes speech recognition component(s), you should understand that speech recognition is an inherently statistical process and that recognition errors are inherent in the process. Neither FORD MOTOR COMPANY nor its suppliers shall be liable for any damages arising out of errors in the speech recognition process.
- **Limitations on Reverse Engineering, Decompilation and Disassembly:** You may not reverse engineer, decompile, or disassemble nor permit others to reverse engineer, decompile or disassemble the SOFTWARE, except and only to the extent that such activity is expressly permitted by applicable law notwithstanding this limitation.
- **Limitations on Distributing, Copying, Modifying and Creating Derivative Works:** You may not distribute, copy, make modifications to or create derivative works based on the SOFTWARE, except and only to the extent that such activity is expressly permitted by applicable law notwithstanding this limitation.
- **Single EULA:** The end user documentation for the DEVICE and related systems and services may contain multiple EULAs, such as multiple translations and/or multiple media versions (e.g., in the user documentation and in the software). Even if you receive multiple EULAs, you are licensed to use only one (1) copy of the SOFTWARE.
- **SOFTWARE Transfer:** You may permanently transfer your rights under this EULA only as part of a sale or transfer of the DEVICE, provided you retain no copies, you transfer all of the SOFTWARE (including all component parts, the media and printed materials, any upgrades, and, if applicable, the Certificate(s) of Authenticity), and the recipient agrees to the terms of this EULA. If the SOFTWARE is an upgrade, any transfer must include all prior versions of the SOFTWARE.
- **Termination:** Without prejudice to any other rights, FORD MOTOR COMPANY or MS may terminate this EULA if you fail to comply with the terms and conditions of this EULA.

- **Security Updates/Digital Rights Management:** Content owners use the WMDRM technology included in your DEVICE to protect their intellectual property, included copyrighted content. Portions of the SOFTWARE on your DEVICE use WMDRM software to access WMDRM-protected content. If the WMDRM software fails to protect the content, content owners may ask Microsoft to revoke the SOFTWARE's ability to use WMDRM to play or copy protected content. This action does not affect unprotected content. When your DEVICE downloads licenses for protected content, you agree that Microsoft may include a revocation list with the licenses. Content owners may require you to upgrade the SOFTWARE on your DEVICE to access their content. If you decline an upgrade, you will not be able to access content that requires the upgrade.
- **Consent to Use of Data:** You agree that MS, Microsoft Corporation, FORD MOTOR COMPANY, third party software and systems suppliers, their affiliates and/or their designated agent may collect and use technical information gathered in any manner as part of product support services related to the SOFTWARE or related services. MS, Microsoft Corporation, FORD MOTOR COMPANY, third party software and services suppliers, their affiliates and/or their designated agent may use this information solely to improve their products or to provide customized services or technologies to you. MS, Microsoft Corporation, FORD MOTOR COMPANY, third party software and systems suppliers, their affiliates and/or their designated agent may disclose this information to others, but not in a form that personally identifies you.
- **Internet-Based Services Components:** The SOFTWARE may contain components that enable and facilitate the use of certain Internet-based services. You acknowledge and agree that MS, Microsoft Corporation, FORD MOTOR COMPANY, third party software and service suppliers, their affiliates and/or their designated agent may automatically check the version of the SOFTWARE and/or its components that you are utilizing and may provide upgrades or supplements to the SOFTWARE that may be automatically downloaded to your DEVICE.
- **Additional Software/Services:** The SOFTWARE may permit FORD MOTOR COMPANY, third party software and service suppliers, MS, Microsoft Corporation, their affiliates and/or their designated agent to provide or make available to you SOFTWARE updates, supplements, add-on components, or Internet-based services components of the SOFTWARE after the date you obtain your initial copy of the SOFTWARE ("Supplemental Components").

If FORD MOTOR COMPANY or third party software and services suppliers provide or make available to you Supplemental Components and no other EULA terms are provided along with the Supplemental Components, then the terms of this EULA shall apply.

If MS, Microsoft Corporation, their affiliates and/or their designated agent make available Supplemental Components, and no other EULA terms are provided, then the terms of this EULA shall apply, except that the MS, Microsoft Corporation or affiliate entity providing the Supplemental Component(s) shall be the licensor of the Supplemental Component(s).

FORD MOTOR COMPANY, MS, Microsoft Corporation, their affiliates and/or their designated agent reserve the right to discontinue without liability any Internet-based services provided to you or made available to you through the use of the SOFTWARE.

- **Links to Third Party Sites:** The MS SOFTWARE may provide you with the ability to link to third party sites through the use of the SOFTWARE. The third party sites are not under the control of MS, Microsoft Corporation, their affiliates and/or their designated agent. Neither MS nor Microsoft Corporation nor their affiliates nor their designated agent are responsible for (i) the contents of any third party sites, any links contained in third party sites, or any changes or updates to third party sites, or (ii) webcasting or any other form of transmission received from any third party sites. If the SOFTWARE provides links to third party sites, those links are provided to you only as a convenience, and the inclusion of any link does not imply an endorsement of the third party site by MS, Microsoft Corporation, their affiliates and/or their designated agent.
- **Obligation to Drive Responsibly:** You recognize your obligation to drive responsibly and keep attention on the road. You will read and abide with the DEVICE operating instructions particularly as they pertain to safety and assumes any risk associated with the use of the DEVICE.

UPGRADES AND RECOVERY MEDIA: If the SOFTWARE is provided by FORD MOTOR COMPANY separate from the DEVICE on media such as a ROM chip, CD ROM disk(s) or via web download or other means, and is labeled "For Upgrade Purposes Only" or "For Recovery Purposes Only" you may install one (1) copy of such SOFTWARE onto the DEVICE as a replacement copy for the existing SOFTWARE, and use it in accordance with this EULA, including any additional EULA terms accompanying the upgrade SOFTWARE.

INTELLECTUAL PROPERTY RIGHTS: All title and intellectual property rights in and to the SOFTWARE (including but not limited to any images, photographs, animations, video, audio, music, text and “applets,” incorporated into the SOFTWARE), the accompanying printed materials, and any copies of the SOFTWARE, are owned by MS, Microsoft Corporation, FORD MOTOR COMPANY, or their affiliates or suppliers. The SOFTWARE is licensed, not sold. You may not copy the printed materials accompanying the SOFTWARE. All title and intellectual property rights in and to the content which may be accessed through use of the SOFTWARE is the property of the respective content owner and may be protected by applicable copyright or other intellectual property laws and treaties. This EULA grants you no rights to use such content. All rights not specifically granted under this EULA are reserved by MS, Microsoft Corporation, FORD MOTOR COMPANY, third party software and service providers, their affiliates and suppliers. Use of any on-line services which may be accessed through the SOFTWARE may be governed by the respective terms of use relating to such services. If this SOFTWARE contains documentation that is provided only in electronic form, you may print one copy of such electronic documentation.

EXPORT RESTRICTIONS: You acknowledge that the SOFTWARE is subject to U.S. and European Union export jurisdiction. You agree to comply with all applicable international and national laws that apply to the SOFTWARE, including the U.S. Export Administration Regulations, as well as end-user, end-use and destination restrictions issued by U.S. and other governments. For additional information, see <http://www.microsoft.com/exporting/>.

TRADEMARKS: This EULA does not grant you any rights in connection with any trademarks or service marks of FORD MOTOR COMPANY, MS, Microsoft Corporation, third party software or service providers, their affiliates or suppliers.

PRODUCT SUPPORT: Product support for the SOFTWARE is not provided by MS, its parent corporation Microsoft Corporation, or their affiliates or subsidiaries. For product support, please refer to FORD MOTOR COMPANY instructions provided in the documentation for the DEVICE. Should you have any questions concerning this EULA, or if you desire to contact FORD MOTOR COMPANY for any other reason, please refer to the address provided in the documentation for the DEVICE.

No Liability for Certain Damages: EXCEPT AS PROHIBITED BY LAW, FORD MOTOR COMPANY, ANY THIRD PARTY SOFTWARE OR SERVICES SUPPLIERS, MS, MICROSOFT CORPORATION AND THEIR AFFILIATES SHALL HAVE NO LIABILITY FOR ANY INDIRECT, SPECIAL, CONSEQUENTIAL OR INCIDENTAL DAMAGES ARISING FROM OR IN CONNECTION WITH THE USE OR PERFORMANCE OF THE SOFTWARE. THIS LIMITATION SHALL APPLY EVEN IF ANY REMEDY FAILS OF ITS ESSENTIAL PURPOSE. IN NO EVENT SHALL MS, MICROSOFT CORPORATION AND/OR THEIR AFFILIATES BE LIABLE FOR ANY AMOUNT IN EXCESS OF U.S. TWO HUNDRED FIFTY DOLLARS (U.S.\$250.00).

- THERE ARE NO WARRANTIES OTHER THAN THOSE THAT MAY EXPRESSLY BE PROVIDED FOR YOUR NEW VEHICLE.

Adobe

Contains Adobe® [Flash® Player] or [AIR®] technology by Adobe Systems Incorporated. This [Licensee Product] contains [Adobe® Flash® Player] [Adobe® AIR®] software under license from Adobe Systems Incorporated, Copyright © 1995-2009 Adobe Macromedia Software LLC. All rights reserved. Adobe, Flash and AIR are trademarks of Adobe Systems Incorporated.

End user notice**Microsoft® Windows® Mobile for Automotive Important Safety Information**

This system Ford SYNC™ contains software that is licensed to Manufacturer FORD MOTOR COMPANY by an affiliate of Microsoft Corporation pursuant to a license agreement. Any removal, reproduction, reverse engineering or other unauthorized use of the software from this system in violation of the license agreement is strictly prohibited and may subject you to legal action.

Read and follow instructions

Before using your Windows Automotive-based system, read and follow all instructions and safety information provided in this end user manual (“User’s Guide”). Not following precautions found in this User’s Guide can lead to an accident or other serious consequences.

Keep User's Guide in Vehicle

When kept in the vehicle, the User's Guide will be a ready reference for you and other users unfamiliar with the Windows Automotive-based system. Please make certain that before using the system for the first time, all persons have access to the User's Guide and read its instructions and safety information carefully.



WARNING: Operating certain parts of this system while driving can distract your attention away from the road, and possibly cause an accident or other serious consequences. Do not change system settings or enter data non-verbally (using your hands) while driving. Stop the vehicle in a safe and legal manner before attempting these operations. This is important since while setting up or changing some functions you might be required to distract your attention away from the road and remove your hands from the wheel.

General operation**Voice Command Control**

Functions within the Windows Automotive-based system may be accomplished using only voice commands. Using voice commands while driving allows you to operate the system without removing your hands from the wheel.

Prolonged Views of Screen

Do not access any function requiring a prolonged view of the screen while you are driving. Pull over in a safe and legal manner before attempting to access a function of the system requiring prolonged attention. Even occasional short scans to the screen may be hazardous if your attention has been diverted away from your driving task at a critical time.

Volume Setting

Do not raise the volume excessively. Keep the volume at a level where you can still hear outside traffic and emergency signals while driving. Driving while unable to hear these sounds could cause an accident.

Use of Speech Recognition Functions

Speech recognition software is inherently a statistical process which is subject to errors. It is your responsibility to monitor any speech recognition functions included in the system and address any errors.

Navigation Features

Any navigation features included in the system are intended to provide turn by turn instructions to get you to a desired destination. Please make certain all persons using this system carefully read and follow instructions and safety information fully.

Distraction Hazard

Any navigation features may require manual (non-verbal) setup. Attempting to perform such set-up or insert data while driving can seriously distract your attention and could cause an accident or other serious consequences. Stop the vehicle in a safe and legal manner before attempting these operations.

Let Your Judgment Prevail

Any navigation features are provided only as an aid. Make your driving decisions based on your observations of local conditions and existing traffic regulations. Any such feature is not a substitute for your personal judgment. Any route suggestions made by this system should never replace any local traffic regulations or your personal judgment or knowledge of safe driving practices.

Route Safety

Do not follow the route suggestions if doing so would result in an unsafe or illegal maneuver, if you would be placed in an unsafe situation, or if you would be directed into an area that you consider unsafe. The driver is ultimately responsible for the safe operation of the vehicle and therefore, must evaluate whether it is safe to follow the suggested directions.

Potential Map Inaccuracy

Maps used by this system may be inaccurate because of changes in roads, traffic controls or driving conditions. Always use good judgment and common sense when following the suggested routes.

Emergency Services

Do not rely on any navigation features included in the system to route you to emergency services. Ask local authorities or an emergency services operator for these locations. Not all emergency services such as police, fire stations, hospitals and clinics are likely to be contained in the map database for such navigation features.

-
- 911 Assist™338
- A**
- ABS (see Brakes)148
- Accessing call history/phone
book during active call328
- Accessing your media menu
features350
- Accessing your phone menu
features329
- Active call menu options328
- Advanced menu options ...336, 357
- Advanced menu options
(prompts, languages, defaults,
master reset, installing
applications)336
- Air cleaner filter236, 280
- Air conditioning88
 manual heating and air
 conditioning system88
- Air filter236, 280
- Air suspension171
- Antifreeze (see Engine
coolant)219
- Anti-lock brake system
(see Brakes)148
- AppLink™346
- Audio system
 Single CD79–80
- Audio system (see Radio) ...79–80
- Automatic transmission136–137
 fluid, adding223
 fluid, checking223
 fluid, refill capacities277
 fluid, specification264
- Auxiliary input jack (Line in)82
- Auxiliary powerpoint101
- Axle143, 207, 226
 lubricant specifications264
 refill capacities277
- B**
- Battery233
 acid, treating emergencies185
 jumping a disabled battery185
 maintenance-free233
 replacement, specifications ...280
 servicing233
- Booster seats31
- Brakelamp
 bulb replacement239
- Brakes147–148, 208
 adjustment211
 anti-lock148
 anti-lock brake system (ABS)
 warning light148
 brake warning light148
 fluid, checking and adding ...229
 fluid, specifications264
 parking158, 161, 211
 shift interlock136
 trailer176
- Bulbs241
- C**
- Catalytic converter
(see Emission control)213
- CD79–80
- CD player77
- Cell phone use12
- Child safety seats
 attaching with tether straps36
 LATCH36

Child safety seats - booster seats	31	Defrost	88
Cleaning your vehicle	242	Diesel exhaust fluid (DEF)	120
engine compartment	245	Diesel Particulate Filter (DPF)	106
exterior	242	Dipstick	
instrument panel	247	automatic transmission fluid ...	223
interior	246	engine oil	217
plastic parts	244	Doors	
washing	242	lubricant specifications	264
waxing	244	Drivebelt	263
wheels	248	Driving under special conditions	
wiper blades	245	through water	183
Climate control (see Air conditioning or Heating)	88	E	
Clock	79–80	Electronic message center	74
Clutch	133, 229	Emergencies, roadside	
adjusting	230	jump-starting	185
fluid	229	running out of fuel	116
specifications	264	Emergency Flashers	185
Coolant	219	Emission control system ..130, 288	
checking and adding	219	catalytic converter	213
refill capacities	277	End user license agreement	364
specifications	264	Engine	263
Cruise control	166	cleaning	245
Customer Assistance	184	coolant	219
Getting assistance outside the U.S. and Canada	191	fail-safe cooling	222
Getting roadside assistance ...	184	lubrication specifications	264
Getting the service you need	189, 204	Engine block heater	111
Ordering additional owner's literature	192	Engine fan	219
Utilizing the Mediation/Arbitration Program	191	Engine oil	
D		checking and adding	217–218
Daytime running lamps (see Lamps)	57	dipstick	217
		filter, specifications	280
		refill capacities	277
		specifications	264

-
- Exhaust fumes104
- F**
- Fail safe cooling222
- Fan, Engine Cooling219
- Filter
fuel232
- Fuel
cap118
capacity277
filler funnel116
filling your vehicle with fuel ..118
octane rating116, 263
quality114
running out of fuel116
safety information relating to
automotive fuels113
- Fuses194–195, 203
- G**
- Gas cap (see Fuel cap)118
- Gauges64, 66
- H**
- Hazard flashers185
- Headlamps56
aiming239
bulb specifications241
daytime running lights57
flash to pass56
replacing bulbs239
turning on and off56
- Head restraints92
- Heating88
- Hood215
- I**
- Ignition103, 263
- Information displays74
- Instrument panel
cleaning247
cluster68
lighting up panel and
interior57
- J**
- Joining two calls
(multiparty/conference call)328
- Jump-starting your vehicle185
- K**
- Keys
positions of the ignition103
- L**
- Lamps56
bulb replacement
specifications chart241
daytime running light57
headlamps56
headlamps, flash to pass56
instrument panel, dimming57
interior lamps58–59
replacing bulbs239
- Lane change indicator
(see Turn signal)58
- LATCH anchors36
- Lights, warning and indicator68
- Load limits174
- Locks
childproof40
doors53

-
- Lubricant specifications264
- Lumbar support, seats95
- M**
- Manual transmission132
 lubricant specifications264
- Media Bluetooth menu options
 (adding, connecting, deleting,
 turning on/off)356
- Message center74
 warning messages76
- Mirrors60
 fold away62–63
 side view mirrors (power)61
- Motorcraft® parts242, 280
- O**
- Octane rating116
- P**
- Pairing other phones325
- Pairing your phone for the first
 time324
- Parking brake158, 161
- Parts
 (see Motorcraft® parts)280
- Phone Bluetooth menu options
 (adding, connecting, deleting,
 turning on/off)335
- Phone redial329
- Playing music (by artist,
 album, genre, playlist, tracks,
 similar)353
- Power distribution box
 (see Fuses)195
- Power door locks53
- Power mirrors61
- Powerpoint101
- Power steering170, 212
 fluid, checking and adding231
 fluid, refill capacity277
 fluid, specifications264
- Power Windows59
- Privacy information321
- Putting a call on/off hold328
- R**
- Radio79–80
 Single CD79–80
- Radio reception77
- Rear window defroster88
- Receiving a text message331
- Recommendations for
 attaching safety restraints for
 children33
- Relays194–195, 199
- Remote entry system
 locking/unlocking doors52
- Roadside assistance184
- S**
- Safety Belt Maintenance51
- Safety belts (see Safety
 restraints)42, 47
- Safety defects, reporting193
- Safety information320
- Safety restraints42–45, 47
 Belt-Minder®48
 extension assembly47

- for adults42–43, 45, 47
 - for children28, 33
 - safety belt maintenance51
 - seat belt maintenance51
 - warning light and chime48
 - Safety restraints - LATCH
 - anchors36
 - Safety seats for children28, 33
 - Safety Compliance Certification Label281
 - Seat belts (see Safety restraints)42
 - Seats
 - child safety seats28, 33
 - front seats96
 - heated99
 - Selecting your media source (USB, Line in, BT audio)350
 - Setting the clock79–80
 - Spark plugs, specifications263, 280
 - Specification chart, lubricants ..264
 - Starting your vehicle103, 105
 - jump starting185
 - Steering212
 - Steering wheel54
 - controls54
 - tilting54
 - Suspension171, 214
 - SYNC® AppLink™346
 - SYNC® customer support320
 - SYNC® Services343
- T**
- Tail lamps
 - bulb replacement239
 - Temperature control (see Climate control)88
 - Text messaging331
 - Text messaging (sending, downloading, deleting)331, 333
 - Tilt steering wheel54
 - Tires252
 - Towing175
 - trailer towing175
 - wrecker179
 - Traction control164
 - Traffic, Directions and Information343
 - Transmission132, 136
 - automatic operation136
 - brake-shift interlock (BSI)136
 - fluid, checking and adding (automatic)223
 - fluid, checking and adding (manual)225
 - fluid, refill capacities277
 - lubricant specifications264
 - manual operation132
 - Turn signal58
- U**
- Upfitter controls172
 - UREA120
 - USB port84
 - Using privacy mode328
- V**
- Vehicle health report341
 - Vehicle Identification Number (VIN)281–282
 - Vehicle loading174

Index

377

Ventilating your vehicle	104	Water, Driving through	183
Voice commands in media mode	348	Wheels	258
Voice commands in phone mode	325	Windows	
W		power	59
Warning lights (see Lights)	68	Windshield washer fluid and wipers	55
Washer fluid	232	checking and adding fluid	232
		replacing wiper blades	236
		Wrecker towing	179