



## Table of Contents

<b>Introduction</b>	<b>2</b>
Welcome	2
Breaking-in your vehicle	4
<b>Focus ST Unique Features</b>	<b>5</b>
Gauges	6
<b>Driving Your Focus ST</b>	<b>10</b>
Transmission operation	10
AdvanceTrac®	11
Engine over-rev	13
<b>Wheels and Tires</b>	<b>14</b>
Wheels	14
Wheel lug nut torque	14
Tire information	15
<b>Roadside Emergencies</b>	<b>18</b>
Wrecker towing	18
<b>Maintenance</b>	<b>19</b>
Under hood overview	19
<b>Capacities and Specifications</b>	<b>21</b>
Engine specifications	21
Technical specifications	26
Transmission code designation	27
<b>Warranty Coverage</b>	<b>28</b>

The information contained in this publication was correct at the time of going to print. In the interest of continuous development, we reserve the right to change specifications, design or equipment at any time without notice or obligation. No part of this publication may be reproduced, transmitted, stored in a retrieval system or translated into any language in any form by any means without our written permission. Errors and omissions excepted.

© Ford Motor Company 2013

## Introduction

### WELCOME

Congratulations on your decision to purchase or lease the latest from the Ford Global Performance Vehicle team – the Focus ST. If you've owned or leased an SVT product in the past, we're glad you're back. If this is your first Ford performance vehicle, welcome to the family! We are confident that our dedication to performance, quality, craftsmanship and customer service will provide many miles of exhilarating, safe and comfortable driving in your new Focus ST.



Your choice of an ST product is an intelligent and informed one. We strive to build engaging vehicles that involve the driver in every aspect of the driving experience. Although performance is at the heart of every ST vehicle, we go much further. Our goal is to deliver a comprehensive, complete vehicle, sweating the details such as the sound of the exhaust, the quality of the interior materials, and the functionality and the comfort of the seats, to make sure that the driver enjoys not only exceptional performance but an outstanding driving environment as well. In the Focus ST, that philosophy is expressed by a sophisticated powertrain, outstanding chassis dynamics and significant interior and exterior enhancements.

## Introduction

This supplement complements your *Focus Owner's Manual* and provides information specific to the Focus ST. By referring to the pages listed in this supplement, you can identify those features, recommendations and specifications unique to your new Focus ST. If there are any discrepancies between this supplement and the *Focus Owner's Manual*, this supplement shall supersede the information found in the *Focus Owner's Manual*.

If you have any questions or concerns regarding your Focus ST, please call the Ford Performance Info Center at 1-800-FORD-SVT (367-3788).

### SVT HISTORY

The Ford Special Vehicle Team (SVT) was established in 1991 to polish the Ford Oval by creating low-volume, factory-produced vehicles designed for those select few whose idea of driving is a high-powered, passionate experience — not just a means of getting from point A to point B.

In a move to support this spirited enthusiasm, Ford Motor Company carefully integrated the wide array of talent in the company into a small, cross-functional group of engineers and product planners, housed together under one roof with a common mission: to create vehicles specifically designed to meet the unique needs and desires of the knowledgeable driving enthusiast.

More than 200000 SVT vehicles have been produced since the 1993 model year. These include the SVT Mustang Cobra and the Cobra R, the SVT F-150 Lightning, the SVT Contour, the SVT Focus, Ford GT, Shelby GT500, GT500KR and the F-150 SVT Raptor.

### TEAM RS HISTORY

TeamRS traces its' roots back nearly 60 years from the Lotus Ford Cortina and Twin Cam Escorts of the mid 1960's, through the first RS branded Escorts of the 1970's to the founding of Special Vehicle Engineering (SVE) in 1980. Through the 1980s and 90s, SVE delivered a breadth of vehicles from exciting XR and RS branded road going performance cars through homologation specials such as the iconic Sierra Cosworth RS500. The first ST (Sport Technology) vehicle appeared in 1996 as the ST24 Mondeo. The first collaboration between Ford's European and North American performance teams appeared in 2002 as the ST170 in Europe and SVT Focus in North America. In 2003, TeamRS replaced SVE in Europe as performance car and motorsport personnel were brought together as one team. TeamRS subsequently created the 2004 Fiesta ST, 2005 Focus ST and 2009 Focus RS.

## **Introduction**

### **GLOBAL PERFORMANCE VEHICLES**

The Global Performance Vehicle group was formally established in 2009, joining the performance product development excellence and heritage of SVT in North America and TeamRS in Europe. The Focus ST is the first vehicle to emerge from this group and represents the best of what Ford performance has to offer from around the globe. Your Focus ST has been designed and developed with the four hallmarks of the Ford Global Performance Group in mind: Performance, Substance, Exclusivity and Value. We are proud and passionate about what we do, and we're glad you have made us your choice.

### **BREAKING-IN YOUR VEHICLE**

Your vehicle does not need an extensive break-in. Try not to drive continuously at the same speed for the first 1000 miles (1600 kilometers) of new vehicle operation. Vary your speed frequently in order to give the moving parts a chance to break in.

Do not add friction modifier compounds or special break-in oils since these additives may prevent piston ring seating.

## Focus ST Unique Features



- 2.0L GTDI EcoBoost I4 engine
- Overboost function for increased torque
- Electronic over-rev function with 6800 RPM redline
- ST-tuned 2.5 inch center exit exhaust system
- Getrag-Ford MMT6 6-speed manual transaxle
- Active sound symposer
- Variable ratio steering
- Modified front suspension knuckle for improved wheel end geometry
- Cast rear knuckle (improved stiffness) and alternative anti-roll-bar mounting for improved efficiency
- ST-tuned springs and dampers
- Increased diameter (320 millimeter) front brake rotors and unique calipers with ST tuned pad formulation front and rear
- Enhanced torque vectoring control with cornering understeer control
- ST-tuned electric power assisted steering with torque steer compensation
- AdvanceTrac® stability enhancement system with three modes: Normal, Sport and Disabled
- 18 inch x 8 inch, 55 millimeter offset aluminum ST wheels
- P235/40-18 directional Goodyear Eagle F1 tires
- ST-engineered front and rear fascias and rear wing

## Focus ST Unique Features

- Optional Recaro front seats with increased lateral support and matching rear seat covers
- Leather wrapped ST sport steering wheel with improved grip contour
- ST-unique instrument panel appliques, shift knob, shift boot and pedal pads

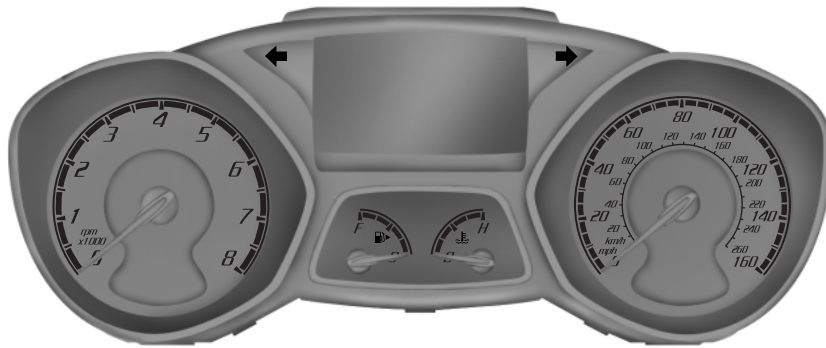

- ST high-speed instrument cluster and auxiliary cluster with oil temperature, oil pressure and boost gauges

### GAUGES

- A. Oil temperature gauge
- B. Turbocharger boost gauge
- C. Oil pressure gauge

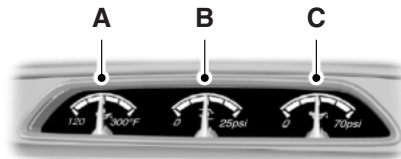

#### Oil temperature gauge

Indicates the temperature of the engine oil.

If it enters the red section, the engine is overheating. Reduce engine speed as soon as safely possible to allow the engine to cool. If the engine is continued to be driven at high engine speeds with the needle in the red section, the engine speed will be reduced automatically to prevent engine damage.

#### Turbocharger boost gauge

Indicates the added intake pressure provided by the turbocharger.

6

## Focus ST Unique Features

### Oil pressure gauge

Indicates engine oil pressure.

During normal driving the indicated oil pressure will vary with engine speed, the pressure rising as engine speed rises and dropping as engine speed drops.

If the engine oil pressure drops below the normal range, the oil pressure gauge pointer will drop into the red section of the gauge scale and the engine oil pressure warning lamp in the main instrument cluster will illuminate. Stop the vehicle as soon as safely possible and switch off the engine immediately. Check the oil level and add oil if needed.

### Vehicle Specifications



Item	Description		
<b>Transmission</b>	GFT MMT6 6-speed manual with 240 mm clutch and dual mass flywheel		
<b>Gear ratios</b>	<i>Gear</i>	<i>Ratio</i>	<i>Final Drive</i>
	1st	3.231	4.063
	2nd	1.952	4.063
	3rd	1.321	4.063
	4th	1.029	4.063
	5th	1.129	2.955
	6th	0.943	2.955
	Reverse	4.600	2.955



## Focus ST Unique Features

### Engine Information

Item	Description
<b>Configuration</b>	Transverse mounted I4, cast aluminum cylinder block and cylinder heads
<b>Bore x Stroke</b>	87.5 mm bore x 83.1 mm stroke (3.44 in. x 3.27 in.)
<b>Displacement</b>	1999 cubic centimeters (122 cubic inches)
<b>Compression ratio</b>	9.3:1
<b>Horsepower</b>	252 hp @ 5500 RPM on 93 octane 243 hp @ 5500 RPM on 87 octane
<b>Torque</b>	270 lb-ft @ 2500 RPM on 93 octane 270 lb-ft @ 2500 RPM on 87 octane
<b>Redline</b>	6500 RPM continuous 6800 RPM 3-second overspeed
<b>Specific output</b>	126 horsepower per liter
<b>Valvetrain</b>	Twin independent variable cam timing
<b>Ignition</b>	Coil-on-plug
<b>Fuel system</b>	150 bar fuel pump
<b>Throttle body</b>	57 mm (2.2 in.)
<b>Pistons</b>	Cast aluminum
<b>Crankshaft</b>	Cast iron
<b>Connecting rods</b>	Forged steel
<b>Turbo</b>	Single scroll / 21 psi max boost*
<b>Exhaust system</b>	63 mm (2.5 in.) diameter

\* SAE Certified Performance ratings are achieved with 19.5 psi, but up to 21 psi can be delivered to maximize power depending on fuel quality and atmospheric conditions.

## Focus ST Unique Features

### SUSPENSION

Item	Description
<b>Front suspension</b>	MacPherson strut with L-arm front suspension
<b>Rear suspension</b>	Fully independent control blade SLA with revised stabar routing
<b>Front spring rate</b>	30 N/mm (171 lb/in.)
<b>Rear spring rate</b>	32 N/mm (183 lb/in.)
<b>Front stabilizer bar</b>	24 mm diameter x 4 mm thick hollow (.944 in x .157 in.)
<b>Rear stabilizer bar</b>	22 mm diameter (.866 in. )

## Driving Your Focus ST

### MANUAL 6-SPEED TRANSMISSION OPERATION



#### Using the Clutch

**Note:** During each shift, the clutch pedal must be fully pressed to the floor and the accelerator fully released. Failure to follow this may cause increased shift efforts, prematurely wear transmission components, or cause gear clash or damage to the transmission. Make sure the floor mat is properly positioned so it does not interfere with the full extension of the clutch pedal.

**Note:** If you attempt to shift when the drive wheels are spinning with a loss of traction, it is possible to cause damage to the transmission. Do not attempt to shift when the drive wheels do not have traction.

**Note:** Do not drive with your foot resting on the clutch pedal or use the clutch pedal to hold your vehicle at a standstill while waiting on a hill. These actions will reduce the life of the clutch and could nullify a clutch warranty claim.

Your vehicle is equipped with a twin disc clutch. Due to the high performance of the powertrain, a certain amount of noise from the transmission is normal.

The manual transmission has a starter interlock that prevents cranking the engine unless the clutch pedal is fully pressed.

To start the vehicle:

1. Make sure the parking brake is fully set.
2. Press the clutch pedal to the floor, then put the transmission selector lever in position **N**.
3. Start the engine, then press the brake pedal and release the parking brake.
4. Move the transmission selector lever to position **1**, then slowly release the clutch pedal while slowly pressing on the accelerator.

10

## Driving Your Focus ST

5. To engage reverse, lift up on the reverse lockout ring located under the shift knob and move the transmission selector lever fully to the left and forward.

### Recommended Shift Speeds for Maximum Fuel Economy

When accelerating, upshift according to the following chart:

Shift from:	
1 - 2	12 mph (19 km/h)
2 - 3	23 mph (37 km/h)
3 - 4	32 mph (51 km/h)
4 - 5	41 mph (66 km/h)
5 - 6	42 mph (67 km/h)

### Operating at High Speeds

Your ST vehicle is capable of high speeds and is equipped with tires rated for the vehicle's maximum speed. Remember to drive safely, obey all traffic laws and only operate your ST vehicle at high speeds at locations equipped and designed to do so safely. Before operating your vehicle at high speeds:

- Verify correct tire pressures (see *Tires* in this supplement).
- Inspect wheels and tires for wear and damage. Replace any damaged wheels or tires.
- Do not operate your vehicle at high speeds with more than two passengers or while carrying cargo.

### ADVANCETRAC® STABILITY ENHANCEMENT SYSTEM

The AdvanceTrac® system includes traction control and electronic stability control. See the *Traction Control* and *Stability Control* chapters of the *Owner's Manual* for more information.

AdvanceTrac® provides three modes of operation specially calibrated for the Focus ST. These are controlled through the AdvanceTrac® button on the center console.



## Driving Your Focus ST

<b>AdvanceTrac® Modes</b>			
Mode	Description	Button Operation	Display
Normal	Daily usage with all driver aids engaged	None	None
Sport	Spirited driving. Thresholds altered on traction control and electronic stability control to allow more tire spin and vehicle slip	Single press	<ul style="list-style-type: none"> <li>• Message center displays Sport Mode</li> <li>• Amber light in cluster illuminates</li> </ul>
Off	Track Use Only Traction control and electronic stability control are disabled	Press and hold for 5 seconds	<ul style="list-style-type: none"> <li>• Message center displays Hold to switch electronic stability control off, then</li> <li>• Electronic Stability Control off</li> <li>• Amber light in cluster illuminates</li> </ul>

### ENHANCED TORQUE VECTORING CONTROL

Enhanced torque vectoring control is comprised of two elements:

- Torque vectoring control which applies brake torque on the inner wheel in a curve for better traction and less understeer
- Cornering understeer control which controls the yaw response of the vehicle under braking and acceleration on high and low friction surfaces.

Unlike electronic stability control, enhanced torque vectoring control does not slow the vehicle but does help control excessive wheel slip and gives the vehicle cornering agility. The system only increases performance. Because of this, enhanced torque vectoring control is not disabled when the AdvanceTrac® system is off.

## Driving Your Focus ST

### ENGINE OVER-REV

**Note:** Always wait until the engine is properly warmed up before running high engine speeds.

Your vehicle is equipped with an over-rev feature to increase the performance range of your Focus ST. The standard maximum engine speed of 6500 RPM is indicated by a narrow redline on the tachometer face. The redline becomes thicker at the over-rev engine speed of 6800 RPM.

This feature allows three seconds of over-rev above 6500 RPM. Once the three second limit has been reached, the electronically controlled rev limit ramps down to 6500 RPM and holds there. Once engine speed has dropped below 6300 RPM, the over-rev timer is reset and three seconds of over-rev up to a maximum of 6800 RPM is enabled.

Do not operate the engine at high RPM and low load for sustained periods of time, as damage may occur.

### OVERBOOST

The Focus ST offers a period of additional torque delivery referred to as overboost or overtorque. This feature of the engine calibration broadens the RPM range of the peak torque curve. This gives improved performance during maneuvers such as passing and vehicle launch.

**Note:** The overboost feature controls a variety of engine parameters to deliver additional torque. Overboost is built into the engine calibration on the Focus ST and no action is required by the driver to engage.

## Wheels and Tires

### WHEELS

Wheel Specifications	
Diameter and width	18 inches x 8.0 inches
Offset	55 mm
Backspacing	6.673 inches
Center bore	63.3 mm
Weight	25 lbs (11 kg)

Your ST vehicle is equipped with unique wheels matched to the tires. These wheels are more susceptible to damage due to their diameter, width and low profile tires. To avoid damage to your wheels:

- Maintain proper tire pressure.
- Exercise caution when using automated, commercial car washes. Hand washing or using touchless commercial car washes without mechanical tracks is the best way to avoid potential damage.
- When installing wheels, always torque lug nuts to specification with a torque wrench.
- Inspect your wheels for damage on a regular basis. If a wheel is damaged, replace it immediately.
- If you encounter an abnormally harsh impact, inspect the outer diameter of your wheels, both inside and out, for damage.

### WHEEL LUG NUT TORQUE SPECIFICATIONS



**WARNING:** When a wheel is installed, always remove any corrosion, dirt or foreign materials present on the mounting surfaces of the wheel or the surface of the wheel hub, brake drum or brake disc that contacts the wheel. Make sure that any fasteners that attach the rotor to the hub are secured so they do not interfere with the mounting surfaces of the wheel. Installing wheels without correct metal-to-metal contact at the wheel mounting surfaces can cause the wheel nuts to loosen and the wheel to come off while the vehicle is in motion, resulting in loss of control.

## Wheels and Tires

Retighten the lug nuts to the specified torque at 500 miles (800 kilometers) after any wheel disturbance (for example, tire rotation, changing a flat tire, wheel removal).

Bolt size	Wheel lug nut torque*	
	ft-lb	N•m
M12 x 1.5 mm	100	135

\* Torque specifications are for nut and bolt threads free of dirt and rust. Use only Ford recommended replacement fasteners.

### TIRE INFORMATION

Tires	Goodyear Eagle F1
Size	235/40-18
Speed rating	Y
Load rating	95
Usage	Summer only
Wheels	18 in. x 8.0 in., 55 mm offset aluminum wheels

Your ST vehicle is equipped with low profile, high performance tires that are designed to optimize the driving dynamics you expect in a ST vehicle. These tires are not optimized for off-road or winter (snow or cold weather) performance, and their ride, noise and wear characteristics are different than non-performance tires. Also, because of their lower profile, the tires are more susceptible to damage due to potholes and rough roads. To make sure that your tires perform as intended, it is important that you maintain your tires properly:

- **Note:** Do not use tire chains on the original wheels and tires of your vehicle. The use of any type of tire chain on these tires may damage your vehicle.
- Do not overload your vehicle. Maximum vehicle and axle weights are listed on the tire information placard.
- Extra caution should be taken when operating the vehicle near its maximum load, including assuring proper tire pressure and reducing speeds.
- Extra caution should be taken when operating on rough roads to avoid impacts that could cause tire damage.
- In the event that you encounter an abnormally harsh impact, inspect your tires for damage.



## Wheels and Tires

- Inspect your tires for damage on a regular basis. If a tire is damaged, replace it immediately.
- Proper suspension alignment is critical for maximum performance and optimal tire wear. If you notice uneven tire wear, have your alignment checked.
- When replacing tires, the only way to maintain original performance is to use the original equipment tire. If a different summer tire is used, it should be the same size, speed rating and load rating as the originally equipped tire. Tires should be replaced as a set of four. Never mix tire brands or models.

### TIRE PRESSURE

- For tire pressures, see the placard located on the B-pillar inside the driver's door.
- Always maintain your tire pressures according to the tire information placard on the driver's door jamb, using an accurate gauge.
- Tire pressures are specified cold and should be checked after the vehicle has been parked for at least three hours. Do not reduce pressure of warm tires.
- Check your tire pressure often to maintain it properly. Tire pressure can diminish over time and fluctuate with temperature.

### WINTER DRIVING

The original equipment tires on your ST vehicle are designed for maximum performance in dry and wet summer conditions. They are not designed for winter use on ice or snow and cannot be used with snow chains. Ford does not recommend using the original equipment tires when temperatures drop to approximately 40°F (5°C) or below (depending on tire wear and environmental conditions) or in snow/ice conditions. If you will be operating your vehicle in these conditions, winter or all-season tires must be used.

- Even with clear, dry driving conditions do not operate your vehicle above posted speed limits or perform high speed maneuvers with winter tires.
- Do not use tire chains on the original wheels and tires of your vehicle. The use of any type of tire chain on these tires may damage your vehicle.

## Wheels and Tires

The following table lists acceptable tire sizes for winter tires. Tire speed and load ratings should match those of the originally equipped tires as closely as possible. If it is required to fit winter tires with a speed rating less than the original equipment tires (to fit snow chains, for example), be aware of the maximum speed rating for the tire and never exceed.

Compatible Snow Tire/Wheel Packages	
Tire size	Required wheel
235/40-18	Original equipment ST wheel or equivalent
235/45-17	Owner supplied. See your Ford dealer for suitable wheels from the Focus lineup
215/50-17	
215/55-16*	
*Required size to prevent vehicle damage if snow chain use is required.	

Please call the Ford Performance Info Center at 1-800-FORD-SVT (367-3788) for specific winter tire recommendations.

### FULL SIZE SPARE

Your Focus ST is equipped with a full size, dissimilar spare tire assembly. Although the spare is a traditional, full size tire (as opposed to a mini spare), it is different in both size and handling characteristics from the standard Focus ST performance tire. Should you need to install the spare tire, the following precautions must be adhered to:

- Because of the different performance characteristics of the spare tire, avoid aggressive steering, braking, acceleration or high speeds when the spare tire is installed.
- Never enable electronic stability control sport mode or fully disable electronic stability control when the spare tire is installed
- Replace the spare tire with the correct original equipment specified tire as soon as possible

The following table lists the specifications for the full size spare tire and wheel assembly. Tire speed and load ratings should match those of the originally equipped tires as closely as possible.

Spare tire	Continental ContiPro Contact
Size	215/55-16
Speed rating	H
Load rating	93
Usage	All season
Wheel	16 in. x 6.5 in. 50 mm offset steel wheels

## Roadside Emergencies

### WRECKER TOWING

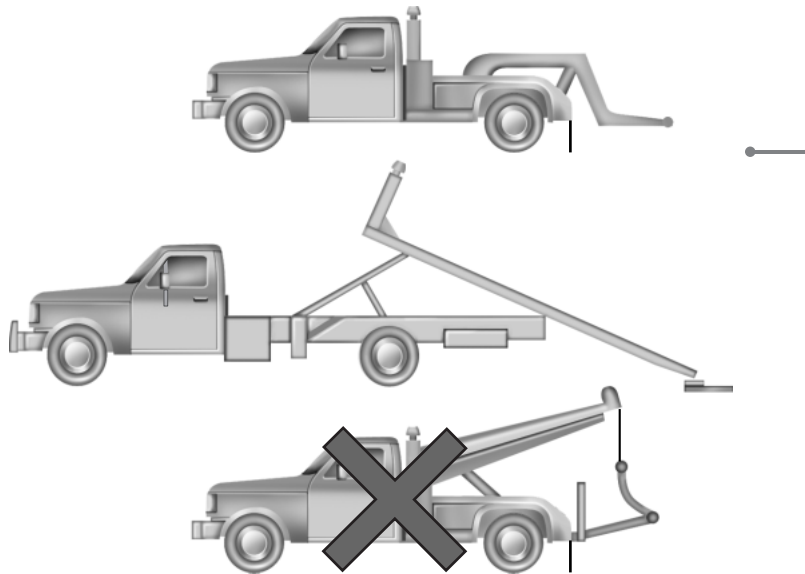

If you need to have your vehicle towed, contact your roadside assistance center or a professional towing service.

It is recommended that your vehicle be towed with a wheel lift and dollies or with flatbed equipment. When towing with a flatbed, 4 x 4 blocks may help prevent damage when loading or unloading your vehicle. Do not tow with a slingbelt. Ford Motor Company has not approved a slingbelt towing procedure.

**Note:** If the vehicle is towed by other means or incorrectly, vehicle damage may occur.

## Maintenance

### UNDER HOOD OVERVIEW

2.0L EcoBoost® Engine

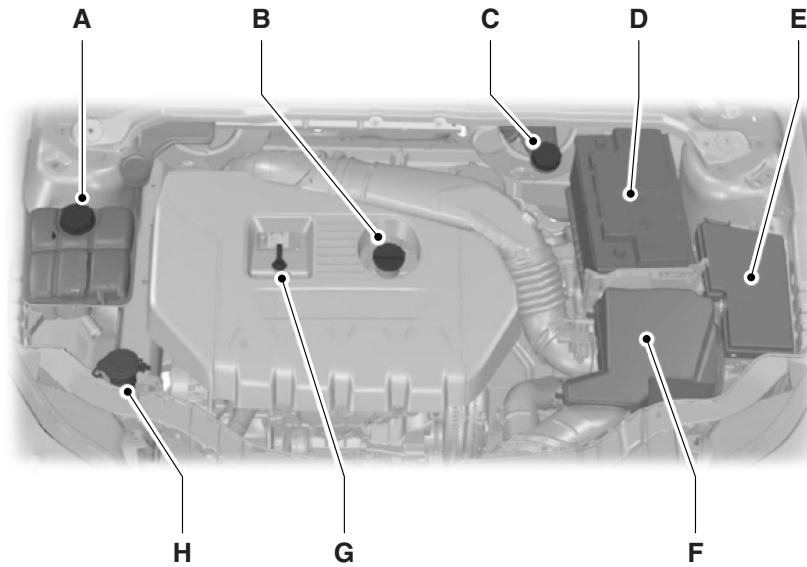

- A. Engine coolant reservoir
- B. Engine oil filler cap
- C. Brake and clutch fluid reservoir
- D. Battery
- E. Power distribution box
- F. Air filter assembly
- G. Engine oil dipstick
- H. Windshield washer fluid reservoir

## Maintenance

### OCTANE RECOMMENDATIONS

Regular unleaded gasoline with a pump (R+M)/2 octane rating of 87 is recommended. Some stations offer fuels posted as Regular with an octane rating below 87, particularly in high altitude areas. Fuels with octane levels below 87 are not recommended. Premium fuel will provide improved performance and is recommended for severe duty usage such as trailer tow.

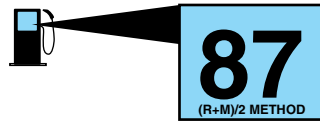

### Towing a Trailer

**Note:** The Focus ST was not designed for towing a trailer. It is not recommended that a trailer of any size or weight be towed.

## Capacities and Specifications

### ENGINE SPECIFICATIONS

Engine	2.0L EcoBoost engine
Cubic inches	122
Required fuel	Minimum 87 octane
Firing order	1-3-4-2
Ignition system	Coil on plug
Compression ratio	9.3:1
Spark plug gap	0.027-0.031 in. (0.70-0.80 mm)

### Drivebelt Routing

2.0L EcoBoost

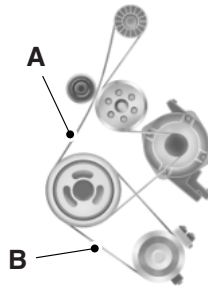

- A. The long drivebelt is on the first pulley groove closest to the engine.
- B. The short drivebelt is on the second pulley groove farthest from the engine.

### CHECKING THE ENGINE OIL

See the *scheduled maintenance information* for the appropriate intervals for checking the engine oil.

1. Make sure the vehicle is on level ground.
2. Turn the engine off and wait 15 minutes for the oil to drain into the oil pan.

**Note:** The oil dipstick on the Focus ST is integrated into the oil drain back system. The oil reading on the dipstick will be influenced by oil draining back into the sump from the cylinder head if the oil level is checked without waiting 15 minutes after shutdown.

## Capacities and Specifications

3. Set the parking brake and make sure the transmission selector lever is securely latched in first gear.
4. Open the hood. Protect yourself from engine heat.
5. Locate and carefully remove the engine oil level dipstick.
6. Wipe the dipstick clean. Insert the dipstick fully, then remove it again.

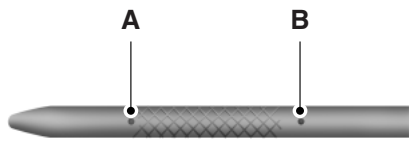

- A. MIN
- B. MAX

- If the oil level is between the MIN and MAX marks, the oil level is acceptable. DO NOT ADD OIL.
  - If the oil level is below the MIN mark, add enough oil to raise the level within the MIN and MAX marks
  - The maximum oil level is between the upper hash mark and the MAX mark. Oil levels above this range may cause engine damage. Some oil must be removed from the engine by an authorized dealer.
7. Put the dipstick back in and make sure it is fully seated.

### ENGINE COOLANT

The concentration and level of engine coolant should be checked at the mileage intervals listed in the *scheduled maintenance information*.

**Note:** Make sure that the level is between the MIN and MAX marks on the engine coolant reservoirs.

**Note:** For best results, coolant concentration should be tested with a refractometer such as Rotunda tool 300-ROB75240E available from your dealer. Ford does not recommend the use of hydrometers or coolant test strips for measuring coolant concentrations.

**Note:** Coolant expands when it is hot. The level may extend beyond the MAX mark. If the level is at the MIN mark, add coolant immediately.

## Capacities and Specifications

Be sure to read and understand *Precautions* in your *Owner's Manual*. If the coolant has not been checked at the recommended interval, the engine or intercooler coolant reservoir may become low or empty. If the reservoir is low or empty, add coolant to the reservoir. See *Adding coolant* in this chapter.

**Note:** Automotive fluids are not interchangeable. Do not use engine coolant, antifreeze or windshield washer fluid outside of its specified function and vehicle location. For more information about engine coolant, see the *Maintenance* chapter of the *Owner's Manual*.

### Adding Engine Coolant



**WARNING:** Do not add coolant when the engine is hot. Steam and scalding liquids released from a hot cooling system can burn you badly. Also, you can be burned if you spill coolant on hot engine parts.



**WARNING:** Do not put coolant in the windshield washer fluid container. If sprayed on the windshield, coolant could make it difficult to see through the windshield.



**WARNING:** To reduce the risk of personal injury, make sure the engine is cool before unscrewing the coolant pressure relief cap. The cooling system is under pressure; steam and hot liquid can come out forcefully when the cap is loosened slightly.



**WARNING:** Do not add coolant further than the MAX mark.

**Note:** Do not use stop leak pellets, cooling system sealants, or additives as they can cause damage to the engine cooling or heating systems. This damage would not be covered under your vehicle's warranty.

**Note:** During normal vehicle operation, the engine coolant may change color from orange to pink or light red. As long as the engine coolant is clear and uncontaminated, this color change does not indicate the engine coolant has degraded nor does it require the engine coolant to be drained, the system to be flushed, or the engine coolant to be replaced.

- Do not mix different colors or types of coolant in your vehicle. Make sure the correct coolant is used. Mixing of engine coolants may harm your engine's cooling system. The use of an improper coolant may harm engine and cooling system components and may void the warranty.



## Capacities and Specifications

A large amount of water without engine coolant may be added, in case of emergency, to reach a vehicle service location. In this instance, the cooling system must be drained, chemically cleaned with Motorcraft® Premium Cooling System Flush, and refilled with prediluted coolant as soon as possible. Water alone (without engine coolant) can cause engine damage from corrosion, overheating or freezing.

- **Note:** Do not use alcohol, methanol or brine or any engine coolants mixed with alcohol or methanol antifreeze (coolant). Alcohol and other liquids can cause engine damage from overheating or freezing.
- **Note:** Do not add extra inhibitors or additives to the coolant. These can be harmful and compromise the corrosion protection of the engine coolant.

Unscrew the cap slowly. Any pressure will escape as you unscrew the cap.

Add prediluted engine coolant meeting the Ford specification. See *Capacities and Specifications* for more information. Whenever coolant has been added, the coolant level in the coolant reservoir should be checked the next few times you drive the vehicle. If necessary, add enough prediluted coolant to bring the coolant level to the proper level and concentration.

### Coolant Refill Procedure

The following procedure should be used when refilling the cooling system after it has been drained or become extremely low.

1. Remove the pressure relief cap from the coolant reservoir as previously outlined.
2. Slowly add prediluted coolant to the coolant reservoir until the coolant level is between the MIN and MAX marks on the reservoir.
3. Reinstall the pressure relief cap.
4. Start and idle the engine until the upper radiator hose is warm (this indicates that the thermostat is open and coolant is flowing through the entire system).
5. Shut the engine off and let it cool.
6. Remove the pressure relief cap from the coolant reservoir as previously outlined.

## Capacities and Specifications

7. Add prediluted coolant to the coolant reservoir until the coolant level is between the MIN and MAX marks on the reservoir.
8. Reinstall the pressure relief cap.
9. Check the coolant level in the reservoir before you drive your vehicle the next few times (with the engine cool).
10. If necessary, add prediluted coolant to the coolant reservoir until the coolant level is between the MIN and MAX marks on the reservoir.

Whenever coolant has been added, the coolant level in the coolant reservoir should be checked the next few times you drive the vehicle. If necessary, add prediluted coolant to bring the coolant to the proper level.

If you have to add more than 1.0 quart (1.0 liter) of coolant per month, have your dealer check the cooling system. Your cooling system may have a leak. Operating an engine with a low level of coolant can result in engine overheating and possible engine damage.

## Capacities and Specifications

### TECHNICAL SPECIFICATIONS

Item	Capacity	Ford Part Name or Equivalent	Ford Part Number / Ford Specification
Brake fluid <sup>1</sup>	Between MAX and MIN on reservoir	Motorcraft® DOT 4 LV High Performance Motor Vehicle Brake Fluid	PM-20 / WSS-M6C65-A2 and ISO 4925 Class 6
Engine oil <sup>2</sup>	5.7 quarts (5.4L)	<ul style="list-style-type: none"> <li>• Motorcraft® SAE 5W-30 Premium Synthetic Blend Motor Oil</li> <li>• Motorcraft® SAE 5W-30 Full Synthetic Motor Oil</li> </ul>	<ul style="list-style-type: none"> <li>• XO-5W30-QSP (US)</li> <li>• CXO-5W30-LSP12 (Canada)</li> <li>• XO-5W30-QFS (US)</li> <li>• CXO-5W30-LFS12 (Canada) / WSS-M2C946-A with API Certification Mark</li> </ul>
Engine coolant <sup>3</sup>	5.3 quarts (5.0L)	Motorcraft® Orange Antifreeze/Coolant Prediluted	VC-3DIL-B (US) CVC-3DIL-B (Canada) / WSS-M97B44-D2
Transmission fluid	1.8 quarts (1.7L)	Motorcraft® Dual Clutch Transmission Fluid	XT-11-QDC WSS-M2C200-D2

<sup>1</sup>Use only Motorcraft® DOT 4 LV High Performance Brake Fluid or equivalent meeting WSS-M6C65-A2 and ISO 4925 Class 6. Use of any fluid other than the recommended fluid may cause brake system damage.

<sup>2</sup>Your engine has been designed to use engine oil that meets Ford specification or an equivalent engine oil of the recommended viscosity grade that displays the API Certification Mark for gasoline engines. Do not use supplemental engine oil additives, cleaners or other engine treatments. They are unnecessary and could lead to engine damage that is not covered by Ford warranty.

<sup>3</sup>Add the coolant type originally equipped in your vehicle.

## Capacities and Specifications

### MOTORCRAFT PART NUMBERS

Component	2.0L GTDI EcoBoost engine
Engine oil filter*	FL-910-S
Engine air filter	FA-1908
Engine fuel filter	Service for life
Spark plug	CYFS12Y2 (100,000 mile service)

\*Only use the specified replacement engine oil filter. The use of a non-specified oil filter can result in engine damage.

### TRANSMISSION CODE DESIGNATION

Description	Code
Getrag-Ford Transmission (GFT) Six-speed manual transaxle (MMT6)	V

## Warranty Coverage

### WARRANTY COVERAGE

The Focus ST carries the same warranty as other Ford Focus models. This information is covered in its entirety in the warranty information.

Warranty service for the Focus ST or any ST vehicle can be obtained at any Ford dealer nationwide.

Ford Global Performance does not recommend modifying or racing ST, SVT or RS vehicles, as they are designed and built to be driven as delivered from the factory. The warranty information discusses vehicle usage and the installation of aftermarket parts and their effect on warranty coverage.

In the event the vehicle is intended for track use, and the loss of warranty coverage is not of concern, the following vehicle durability actions are required:

- Perform multi-point inspection and the maintenance outlined in the 150000 mile (240000 kilometer) normal maintenance schedule of the scheduled maintenance before and after track use. See the vehicle service manual for removal and installation procedures.
- Replace with Genuine Ford and Motorcraft® service parts as needed.

These actions may not necessarily protect your vehicle from damage in competition conditions. Subjecting your vehicle to competition conditions even with this recommended action may render repairs non-reimbursable under the warranty.