



ESCORT

Your satisfaction is our #1 goal. If you have questions or concerns with your vehicle, we suggest you follow these steps:

1. Contact your Sales Representative or Service Advisor at your selling/servicing dealership.
2. If the inquiry or concern remains unresolved, contact the Sales Manager or Service Manager at the dealership.
3. If the inquiry or concern cannot be resolved at the dealership level, please contact the Ford Customer Assistance Center.

In the United States:

**Ford Motor Company
Customer Assistance Center
300 Renaissance Center
P.O. Box 43360
Detroit, MI 48243
1-800-392-3673 (FORD)
TDD for the hearing impaired: 1-800-232-5952**

In Canada:

**Customer Assistance Centre
Ford Motor Company of Canada, Limited
P.O. Box 2000
Oakville, Ontario L6J 5E4
1-800-565-3673 (FORD)**

Outside the U.S. or Canada:

**FORD MOTOR COMPANY
NAAO EXPORT SALES
1555 Fairlane Drive
Fairlane Business Park #3
Allen Park, Michigan 48101
Telephone: (313) 317-4282
Fax: (313) 390-0804**

All rights reserved. Reproduction by any means, electronic or mechanical, including photocopying, recording, or by any information storage and retrieval system or translation in whole or part is not permitted without written authorization from Ford Motor Company.

Copyright © 1995 Ford Motor Company

Table of Contents

Introductory Information	1
Safety Restraints	9
Starting Your Escort	105
Warning Lights and Gauges	117
Instrument Panel Controls	135
Steering Column Controls	159
Features	169
Electronic Sound Systems	197
Driving Your Escort	223
Roadside Emergencies	243
Customer Assistance	259
Reporting Safety Defects	266
Accessories	271
Servicing Your Escort	279
Quick Index	353
Index	371
Service Station Information	388

Introductory Information

Ford's Commitment to You

At Ford Motor Company, excellence is the continuous commitment to achieve the best result possible. It is dedication to learning what you want, determination to develop the right concept, and execution of that concept with care, precision, and attention to detail. In short, excellence means being the standard by which others are judged.

Our Guiding Principles

- Quality comes first.** For your satisfaction, the quality of our products and services must be our number one priority.
- You are the focus of everything we do.** Our work must be done with you in mind, providing better products and services than our competition.
- Continuous improvement is essential to our success.** We must strive for excellence in everything we do: in our products — in their safety and value — and in our services, our human relations, our competitiveness, and our profitability.
- Employee involvement is our way of life.** We are a team. We must treat one another with trust and respect.
- Dealers and suppliers are our partners.** We must maintain mutually beneficial relationships with dealers, suppliers, and our other business associates.

- **Integrity is never compromised.** Our conduct worldwide must be pursued in a manner that is socially responsible and commands respect for its integrity and for its positive contributions to society.

Things to Know About Using This Guide

Congratulations on the purchase of your new vehicle. This guide has information about the equipment and the options for your new vehicle. You may not have bought all of the options available to you. If you do not know which information applies to your vehicle, talk to your dealer.

This guide describes equipment and gives specifications for equipment that was in effect when this guide was approved for printing. Ford may discontinue models or change specifications or design without any notice and without incurring obligation.

Finding Information in This Guide

After you have read this guide once, you will probably return to it when you have a specific question or need additional information. To help you find specific information quickly, you can use the Quick Index, Table of Contents, or the Index.

The **Quick Index** at the end of the book provides a page number following each item which indicates where detailed information can be found.

Your vehicle may not look exactly like the vehicles shown in the Quick Index illustrations. Some features and components shown in the illustrations may not apply to your particular vehicle. Your vehicle may also have equipment that is not illustrated or mentioned in the Quick Index. If you do not know which illustrated features and components apply to your vehicle, talk to your dealer.

This guide has a **table of contents** at the beginning of the book to show chapter titles.

To use the **Index**, turn to the back of the book and search in the alphabetical listing for the word that best describes the information you need. If the word you chose is not listed, think of other related words and look them up. We have designed the Index so that you can find information under a technical term.

Canadian Owners — French Version

French Owner Guides can be obtained from your dealer or by writing to Ford Motor Company of Canada, Limited, Service Publications, P.O. Box 1580, Station B, Mississauga, Ontario L4Y 4G3.

Your Maintenance Schedule and Record Booklet

The *Maintenance Schedule and Record* booklet lists the services that are most important for keeping your vehicle in good condition. A record log is also provided to help you keep track of all services performed.

About the Warranties

Your vehicle is covered by three types of warranties: **Basic Vehicle Warranty**, **Extended Warranties** on certain parts, and **Emissions Warranties**.

Read your *Warranty Information Booklet* carefully to find out about your vehicle's warranties and your basic rights and responsibilities.

If you lose your *Warranty Information Booklet*, you can get a new one free of charge. Contact any Ford or Lincoln-Mercury dealer, or refer to the addresses and phone numbers on the first page of this owner guide.

Your vehicle is equipped with an Electronic Powertrain Control Module that limits engine and/or vehicle speeds with a cut-out mode to promote durability.

Buying a Ford Extended Service Plan

If you bought your vehicle in the U.S., you can buy a Ford Extended Service Plan for your vehicle. This optional contract provides service protection for a longer period of time than the basic warranty that comes with your vehicle.

You do not have to buy this option when you buy your vehicle. However, your option to purchase the Ford Extended Service Plan runs out after 18 months or 18,000 miles. See your dealer for more details about the Ford Extended Service Plan.

If you purchased a Canadian vehicle and did not take advantage of the Ford Extended Service Plan at the time of purchase, you may still be eligible. See your dealer for the details.

Breaking Your Vehicle In

Your new vehicle goes through an adjustment or break-in period during the first 1,000 miles (1,600 km) that you drive it. During the break-in period, you need to pay careful attention to how you drive your vehicle.

Avoid sudden stops. Because your vehicle has new brake linings, you should take these steps:

- Watch traffic carefully so that you can anticipate when to stop.
- Begin braking well in advance.
- Apply the brakes gradually.

The break-in period for new brake linings lasts for 100 miles (160 km) of city driving or 1,000 miles (1,600 km) of highway driving.

Use only the type of engine oil that Ford recommends. See *Engine oil recommendations* in the Index. Do not use special “break-in” oils.

Cleaning the Outside of Your Vehicle

Washing and Polishing Your Vehicle

Wash the outside of your vehicle, including the underside, with a mild detergent.

DO NOT:

- Wash your vehicle with hot water
- Wash your vehicle while it sits in direct sunlight
- Wash your vehicle while the body is hot

Pollen, bird droppings and tree sap can damage the paint, especially in hot weather. Wash your vehicle as often as necessary to keep it clean.

Take similar precautions if your vehicle is exposed to chemical industrial fallout.

Paint damage resulting from fallout is not related to a defect in paint materials or workmanship and therefore is not covered by warranty. Ford, however, believes that continual improvement in customer satisfaction is a high priority. For this reason, Ford has authorized its dealers to repair, at no charge to the owner, the surfaces of new vehicles damaged by environmental fallout within 12 months or 12,000 miles (20,000 km) of purchase, whichever comes first. Customers may be required to bring their vehicle in for inspection by a Ford representative.

Polish your vehicle to remove harmful deposits and protect the finish.

Cleaning Chrome and Aluminum Parts

Wash chrome and aluminum parts with a mild detergent. Do not use steel wool, abrasive cleaners, fuel, or strong detergents.

Cleaning Plastic Parts

Some of your vehicle's exterior trim parts are plastic. Clean with a tar and road oil remover if necessary. Use a vinyl cleaner for routine cleaning.

Do not clean plastic parts with thinners, solvents or petroleum-based cleaners.

If you have your vehicle rustproofed, remove oversprayed rustproofing with a tar and road oil remover. If rustproofing is not removed from plastic and rubber parts, it can cause deterioration.

Safety Restraints

Important Safety Belt Information

The use of safety belts helps to restrain you and your passengers in case of a collision. In most states and in Canada the law requires their use.

Safety belts provide best restraint when:

- the seatback is upright
- the occupant is sitting upright (not slouched)
- the lap belt is snug and low on the hips
- the shoulder belt is snug against the chest
- the knees are straight forward

To help you remember to fasten your safety belt, a warning light may come on and a chime may sound. See *Safety belt warning light/chime* in the *Warning Lights and Gauges* chapter.

See the following sections in this chapter for directions on how to properly use these safety belts. Also see *Safety Restraints for Children* in this chapter for special instructions about using safety belts for children.

 WARNING
Make sure that you and your passengers wear safety belts. Always drive and ride with your seatback upright and the lap belt snug and low across the hips.

⚠️ WARNING

Passengers should not be allowed to ride in the cargo area. Persons not riding in a seat with a fastened seat belt are much more likely to suffer serious injury in a collision. Cargo should always be secured to prevent it from shifting and causing damage to the vehicle or harm to passengers.

⚠️ WARNING

Never wear the shoulder belt under the arm. Never swing it around the neck over the inside shoulder. Never use a single belt for more than one person or across more than one seating position. Each seating position in your vehicle has a specific safety belt assembly which is made up of one buckle and one tongue that are designed to be used as a pair. Failure to follow these precautions could increase the risk and/or severity of injury in a collision.

⚠️ WARNING

Never drive or ride with a twisted or jammed safety belt. If you cannot untwist or unjam the safety belt, see the nearest qualified technician immediately.

⚠️ WARNING

Children should always ride with the seatback in the fully upright position. When the seatback is not fully upright, there is a greater risk that the child will slide under the safety belt and be seriously injured in a collision.

⚠️ WARNING

Never let a passenger hold a child on his or her lap while the vehicle is moving. The passenger cannot protect the child from injury in a collision.

⚠️ WARNING

Lock the doors of your vehicle before driving to lessen the risk of the door coming open in a collision.

Motorized Shoulder Belt Passive Restraint System (Not available on Canadian vehicles)

The front seat shoulder belts automatically adjust and together with the manual lap belt, help to provide added restraint in the event of a collision.

While you drive, the shoulder belt adjusts to your movement. However, if you brake hard, turn hard, or if your car receives an impact of 5 mph (8 km/h) or more, the shoulder belt locks and helps reduce your forward movement.

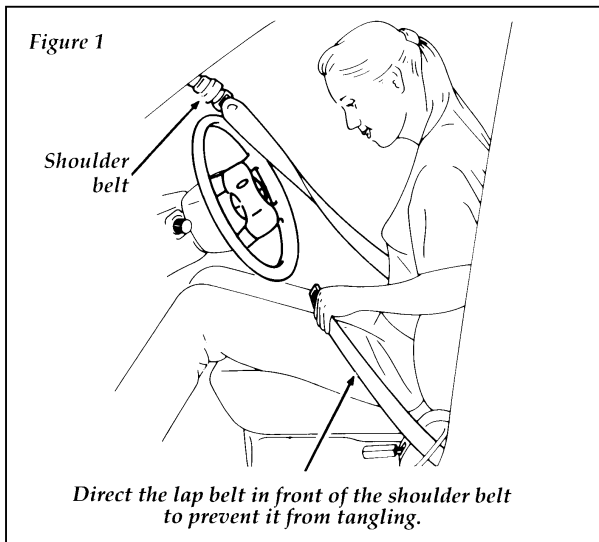

The proper position of the front lap safety belt

⚠ WARNING

The lap belts should fit snugly and as low as possible around the hips, not around the waist.

To operate the motorized shoulder belt:

1. Get into your vehicle and close the door. Check to be sure the shoulder belt is latched to the emergency release buckle.
2. If it is not latched, pull the shoulder belt from the retractor and buckle it to the emergency release buckle. Note the twist in the shoulder belt as in Figures 1 and 2.
3. Turn the ignition key to the ON position.

A motor causes the shoulder belt to slide along its track from the A-pillar to the B-pillar until it locks in place.

If the belt does not lie flat against you, or the belt has a twist in it at the retractor, unlatch the belt at the buckle, remove twist, and relatch the belt into the buckle.

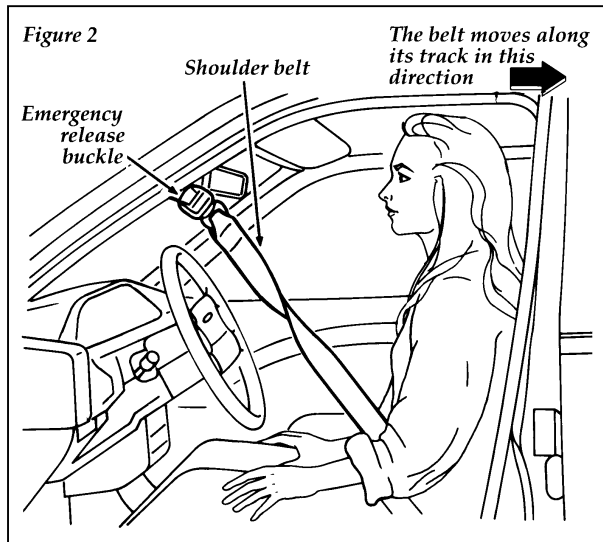

The shoulder belt sliding along its track

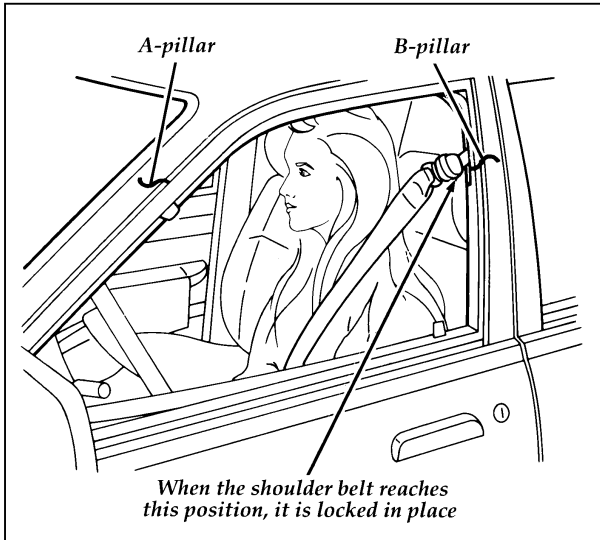

The shoulder belt in the locked position

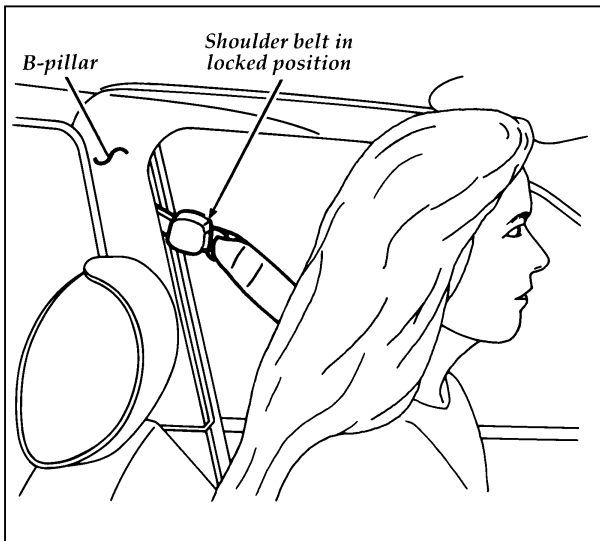

The shoulder belt in the locked position

If the driver does not fasten the lap belt before the ignition key is turned to ON, the chime will sound for four (4) to eight (8) seconds. The safety belt warning indicator lamp in the instrument cluster will also illuminate for one to two minutes. In the unlikely event the shoulder belt should stall before it reaches the B-pillar, the indicator light will flash continuously until the shoulder belt is in its locked position at the B-pillar. If the indicator lamp remains illuminated for more than one minute, check to be sure that both shoulder belts are latched to the emergency release buckle. If the indicator lamp remains illuminated with both front seat shoulder belts latched to the emergency release buckles, refer to the section titled *What To Do If Your Shoulder Belt Does Not Engage Properly* before driving the vehicle.

Use the shoulder belt on the outside shoulder only. Never wear the shoulder belt under the arm. Never swing it around your neck over the inside shoulder. Never use a single belt for more than one person. Failure to follow these precautions could increase the risk and/or severity of injury in a collision.

When the ignition is in any position and the door is opened, the shoulder belt will move forward to the A-pillar. This will allow ample room for the driver or passenger to exit from the vehicle. DO NOT use the belt as an assist handle when entering or exiting the vehicle. The door should not be opened while the vehicle is in motion.

NOTE: Be sure to read and understand *Important Safety Belt Information* at the beginning of this chapter.

⚠ WARNING

To reduce the risk of serious injury in a collision, always drive and ride with your seatback upright and the lap belt snug and low across the hips.

Important For Your Safety

Before driving your vehicle, read the label on the back of the sun visor or on the headliner above the driver's seat (Canadian vehicles). See the following figures.

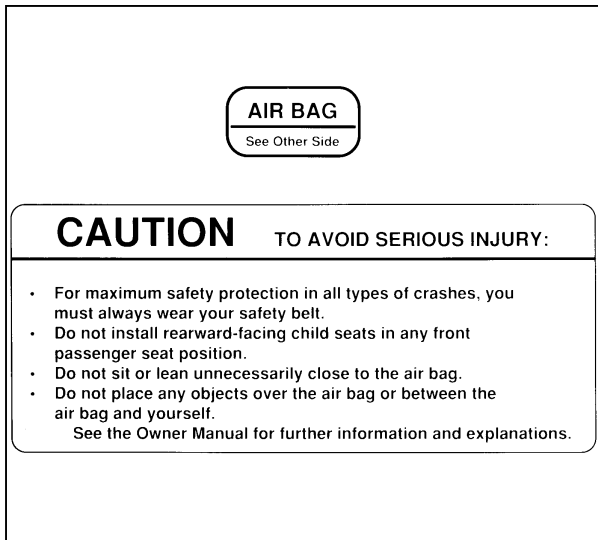

Driver and passenger sun visor labels



Label located on headliner (U.S. vehicles only)

An additional warning label is located on the headliner (U.S. vehicles only). On vehicles equipped with a moon roof, the label is located on the manual override access panel.

What To Do If Your Shoulder Belt Does Not Engage Properly

If your shoulder belt does not move all the way across to the locked position on the B-pillar, follow these steps:

1. Make sure the ignition switch is in the LOCK position.
2. Make sure your door is fully closed. The shoulder belt does not work if your door is open and will remain in the forward position at the A-pillar.

⚠ WARNING

The vehicle should not be driven unless the doors are fully closed and the shoulder belts are in the locked position.

3. Unbuckle the shoulder belt by pressing the red emergency release button on the buckle. Then, reinsert the shoulder belt tongue into the buckle until you hear a snap and feel the latch engage.
4. Turn the key to the ON position.
5. If the shoulder belt doesn't move across you, turn the ignition switch to the LOCK position and then release the shoulder belt from the buckle.
6. Remove the access cap located in the lower portion of the trim panel, rearward of the front door opening.
7. Pull the electrical wiring harness out through the access hole and disconnect the connector. The electrical wiring harness is located near the internal hex nut. To disconnect the connector, pull the left and right sides apart. You may have to loosen the tape to disconnect the electrical connector.
8. Then, insert the emergency handle into the hex nut inside the access hole. The emergency handle is stored in the owner portfolio in the glove compartment.

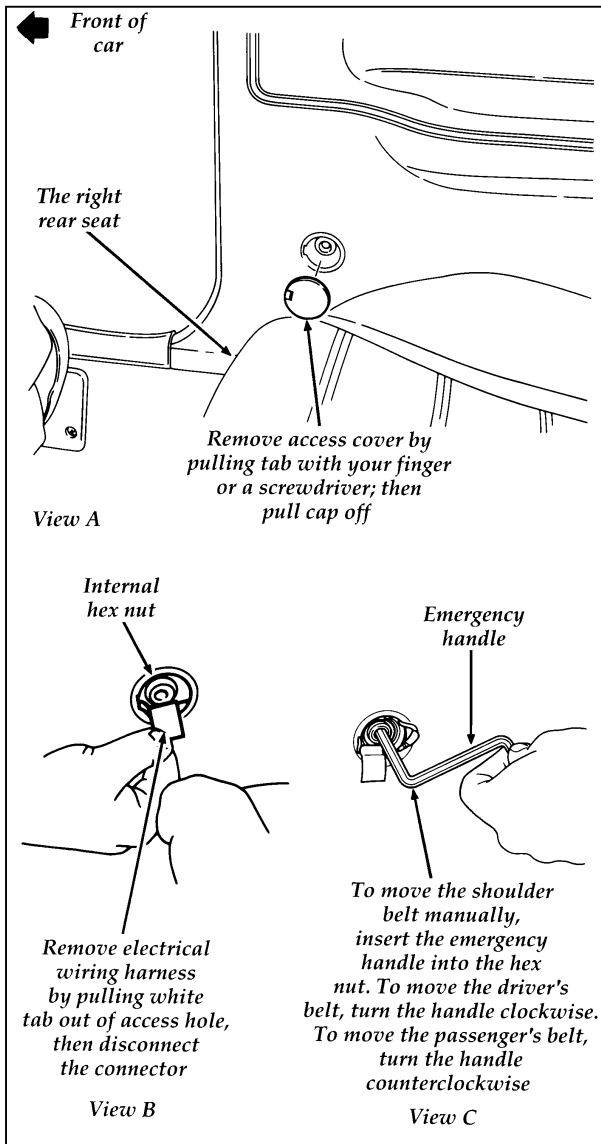

Moving the shoulder belt manually — 2-door model

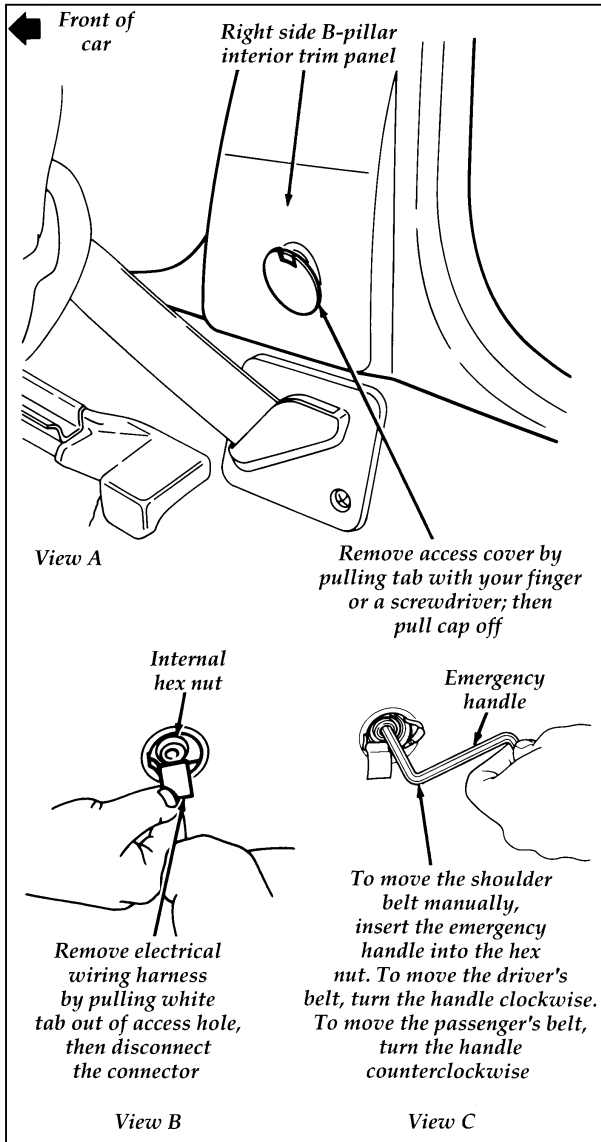

Moving the shoulder belt manually — 4-door model

9. Turn the emergency handle to move the buckle rearward until you hear a click. To move the driver's buckle, turn the handle clockwise. To move the passenger's buckle, turn the handle counterclockwise.
10. Reinsert the shoulder belt tongue into the buckle.

⚠ WARNING

If it is necessary to use the emergency handle to put the shoulder belt in position, have the system serviced by a qualified technician as soon as possible.

Manual Front Lap Belts (U.S. vehicles equipped with motorized passive restraint)

You should always wear the lap belt in addition to the shoulder belt.

⚠ WARNING

The lap belts should fit snugly and as low as possible around the hips, not around the waist.

⚠ WARNING

Front and rear seat occupants, including pregnant women, should wear both lap and shoulder belts for optimum protection in a collision.

To fasten the lap belt: Pull the belt out of the retractor and bring it across your lap. Insert the tongue into the buckle until it snaps and locks in place.

The lap belt retractor will allow the occupant freedom of movement, locking tight only on hard braking, hard cornering or impacts of approximately 5 mph (8 km/h) or more. The retractor can be made to lock by jerking on the belt.

Front passenger safety belts with dual locking mode retractors can also be locked to tightly secure a child safety seat.

Refer to the section *Front Passenger Lap Belt Retractor (U.S. vehicles equipped with motorized passive restraint)* or *Front Passenger Lap/Shoulder Belt Retractor (Canadian 2-door vehicles only)* in this chapter for complete information on vehicle sensitive and automatic locking modes.

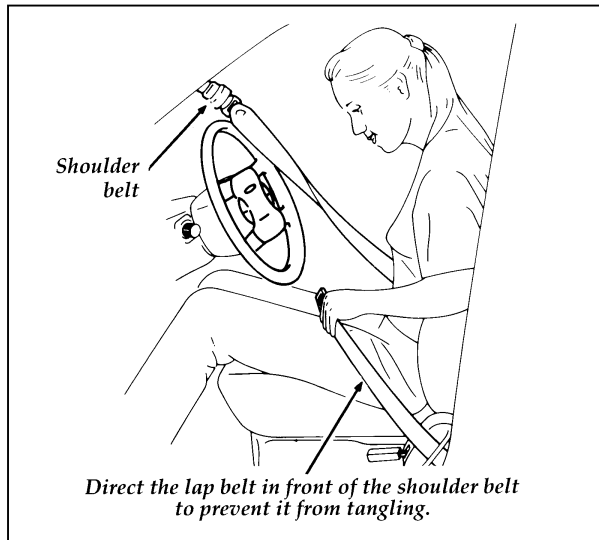

Buckling the lap belt

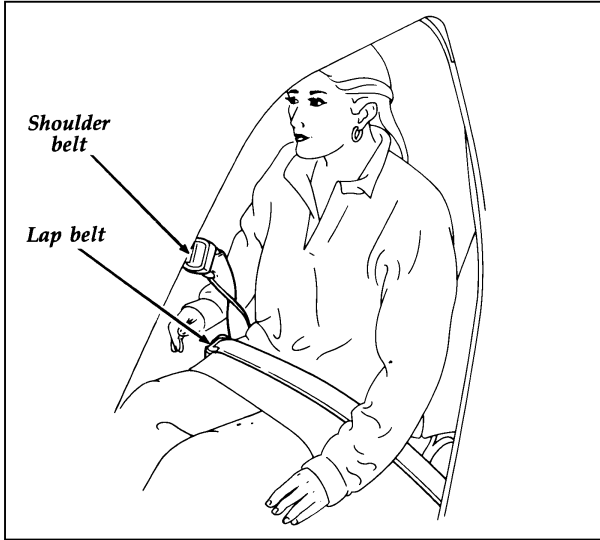

The lap belt fastened

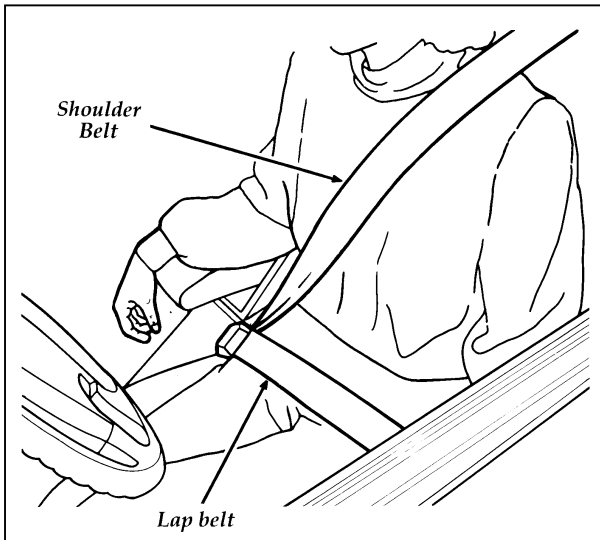

The lap and shoulder belts in place

Front Passenger Lap Belt Retractor (U.S. vehicles equipped with motorized passive restraint)

Your vehicle is equipped with a dual locking mode retractor for the front seat passenger, and the lap belt has the following label:



Seat belt label

The retractor modes function as follows:

Vehicle sensitive (emergency) locking mode

In this operating mode, the lap belt retractor will allow the occupant freedom of movement, locking tight only on hard braking, hard cornering or impacts of approximately 5 mph (8 km/h) or more. The retractor can be made to lock by jerking on the belt.

Automatic locking mode

In this operating mode, the lap belt retractor will remain locked and does not allow the occupant freedom of movement. This mode provides the following:

- A tight lap belt on the hips.
- Forward-facing child seat installation.

 WARNING
--

Rear-facing infant seats should never be placed in the front seat.

This mode **must be used** when installing a forward-facing child seat on the front passenger seat. To switch the retractor from the emergency locking mode, perform the following steps:

1. Buckle the lap belt.
2. Grasp the lap belt below the child seat label. Pull upward until all of the belt is extracted and a click is heard. At this time, the lap belt retractor is in the automatic locking mode (child restraint mode).
3. A clicking sound will continue to be heard as the belt is allowed to retract.
4. Pull down on the belt to remove slack in the belt.

NOTE: When the lap belt is unbuckled and allowed to retract completely, the retractor will switch to the vehicle sensitive (emergency) locking mode. See the detailed instructions under *Safety Seats for Children* in this chapter.

Shoulder Belt Emergency Release Buttons

If the shoulder belt locks up in a collision, it may stay locked. To unlock the belt, press the emergency release button on the shoulder belt buckle. This allows the tongue to unlatch from the buckle. If the shoulder belt is unlatched and partially retracted, a warning light in the instrument panel lights up and remains on; the warning chime sounds for about five (5) seconds.

To insert the tongue back into the shoulder belt buckle, push it in until you hear a click.

If the belt does not lie flat against you, or the belt has a twist in it at the retractor, unlatch the belt at the buckle, remove twist, and relatch the belt into the buckle.

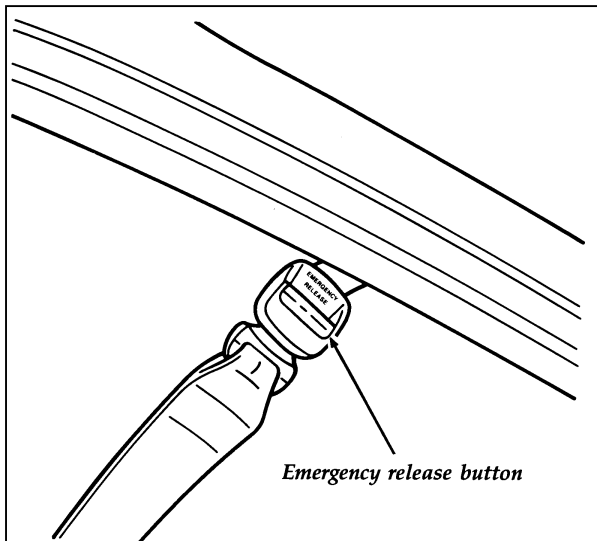

The emergency release button for the shoulder belt

After a collision, refer to *Safety Belt Maintenance* in this section.

If your shoulder belts stop working after a collision, the fuel pump shut-off switch may have been triggered. Minor parking lot bumping and severe road impacts (such as potholes) may trigger the switch even when there is no apparent body damage. In many instances, you might not even know that the switch has been triggered. The shut-off switch cuts power to the motors that move the shoulder belts in addition to stopping the flow of fuel to the engine. To reset the switch, see *Engine, starting after a collision* in the Index.

If your shoulder belts are not working properly, get your vehicle serviced as soon as possible.

If the fuel pump shut-off switch is not the cause for the shoulder belt not moving, have the system serviced by a qualified technician as soon as possible.

 **WARNING**

If the shoulder belt is released from the emergency release buckle, store the tongue end away from the seat tracks. Failure to do this may result in the seat belt being cut or torn when the seat is adjusted forward or back. Any damaged shoulder belt must be replaced.

Manual Front Lap and Shoulder Belt (Available only on Canadian vehicles)

While in motion, the combination lap and shoulder belt adjusts to your movement. However, if you brake hard, turn hard, or if your vehicle receives an impact of 5 mph (8 km/h) or more, the lap and shoulder belt locks and helps reduce your forward movement. The retractor can be made to lock by jerking on the belt.

Front passenger safety belts with dual locking mode retractors can also be locked to tightly secure a child safety seat.

After you get into your vehicle, close the door and lock it. Then adjust the driver or passenger seat to the position that suits you best.

To fasten the belt, find the long strap of the belt, pull it across your shoulder and chest, and insert the tongue into the proper buckle on your seat until you hear a snap and feel it lock. Be sure to use the correct buckle and check to make sure the tongue is securely fastened to the buckle.

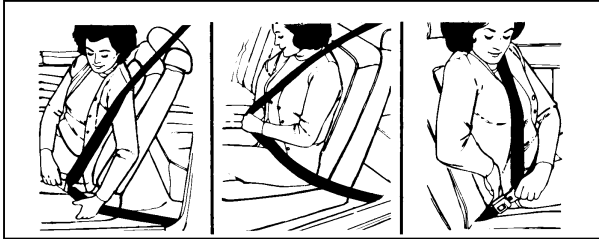

Fastening the front seat lap and shoulder belt

⚠ WARNING

The lap belts should fit snugly and as low as possible around the hips, not around the waist.

⚠ WARNING

Front and rear seat occupants, including pregnant women, should wear both lap and shoulder belts for optimum protection in a collision.

⚠ WARNING

Use the shoulder belt on the outside shoulder only. Never wear the shoulder belt under the arm. Never swing it around the neck over the inside shoulder. Never use a single belt for more than one person. Failure to follow these precautions could increase the risk and/or severity of injury in a collision.

Front Passenger Lap/Shoulder Belt Retractor (Canadian 2-door vehicles only)

Your vehicle is equipped with one of two front passenger lap belts depending upon when your vehicle was built.

If your vehicle is equipped with a dual locking mode retractor for the front seat passenger, the lap belt will have the following label:

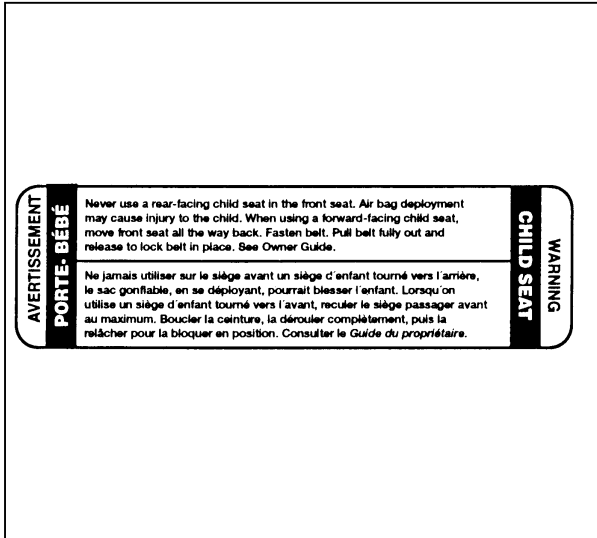

Seat belt label

For vehicles equipped with a dual locking mode retractor for the front seat passenger, the retractor modes function as follows:

Vehicle sensitive (emergency) locking mode retractors

The lap/shoulder belt retractor will allow the occupant freedom of movement, locking tight only on hard braking, hard cornering or impacts of approximately 5 mph (8 km/h) or more. The retractor can be made to lock by jerking on the belt.

Adjust the lap part of the belt by pulling up on the shoulder belt until the lap belt fits snugly and as low as possible around your hips.

Automatic locking mode

In this operating mode, the shoulder belt retractor will be automatically locked and remain locked when the combination lap/shoulder safety belt is buckled, and does not allow the occupant freedom of movement. This mode provides the following:

- A tight lap/shoulder belt fit on the occupant.
- Child seat or infant carrier installation restraint.

 WARNING
Rear-facing infant seats should never be placed in the front seats.

This mode must be used when installing a forward-facing child safety seat on the front passenger seat. To switch the retractor from the emergency locking mode to the automatic locking mode, perform the following steps:

1. Buckle the lap/shoulder combination belt.
2. Grasp the shoulder portion of the belt and pull downward until all of the belt is extracted, and when allowed to retract, a clicking sound will be heard. At this time, the belt retractor is in the automatic locking mode (child restraint mode).
3. A clicking sound will continue to be heard as the belt is allowed to retract. This indicates that the retractor is in the automatic locking mode.

NOTE: When the combination lap/shoulder belt is unbuckled and allowed to retract completely, the retractor will switch back to the vehicle sensitive (emergency) locking mode. See the detailed instructions under *Safety Seats for Children* in this chapter.

If your vehicle is not equipped with a dual locking mode retractor for the front seat passenger, the lap belt will have the following label:

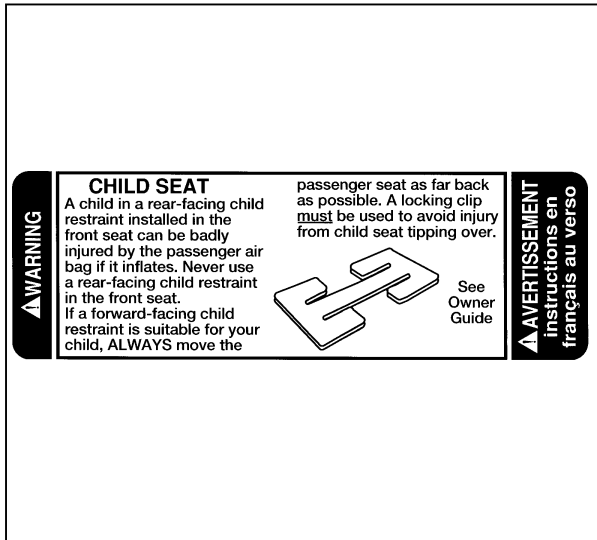

Seat belt label

Instructions for using a locking clip to secure child safety seats with manual lap and shoulder safety belts are provided later in this chapter.

Front Passenger Lap/Shoulder Belt Retractor (Canadian vehicles — 4-door sedan, 4-door hatchback and wagon only)

Your vehicle is equipped with a dual locking mode retractor for the front seat passenger, and the lap belt has the following label:



Seat belt label

Dual locking mode passenger seat lap belt retractor

Your vehicle is equipped with a dual locking mode retractor on the **lap belt** part of the lap/shoulder belt for the front seat passenger. The retractor modes function as follows:

Vehicle sensitive (emergency) locking mode

In this operating mode, the lap belt retractor will allow the occupant freedom of movement, locking tight only on hard braking, hard cornering or impacts of approximately 5 mph (8 km/h) or more. The retractor can be made to lock by jerking on the belt.

Automatic locking mode

In this operating mode, the lap belt retractor will remain locked and does not allow the occupant freedom of movement. This mode provides the following:

- A tight lap belt on the hips
- Forward-facing child seat installation.

 WARNING
--

Rear-facing infant seats should never be placed in the front seat.

This mode **must be used** when installing a forward-facing child seat on the front passenger seat. To switch the retractor from the emergency locking mode to the automatic locking mode, perform the following steps:

1. Buckle the lap/shoulder combination belt.
2. Grasp the lap portion of the belt below the child seat label. Pull upward until all of the belt is extracted and a click is heard. At this time, the lap belt retractor is in the automatic locking mode (child restraint mode).
3. A clicking sound will continue to be heard as the belt is allowed to retract.
4. Push down on the child seat while you pull down on the belt to remove slack in the belt.

NOTE: When the combination lap/shoulder belt is unbuckled and allowed to retract completely, the retractor will switch to the vehicle sensitive (emergency) locking mode. See the detailed instructions under *Safety Seats for Children* in this chapter.

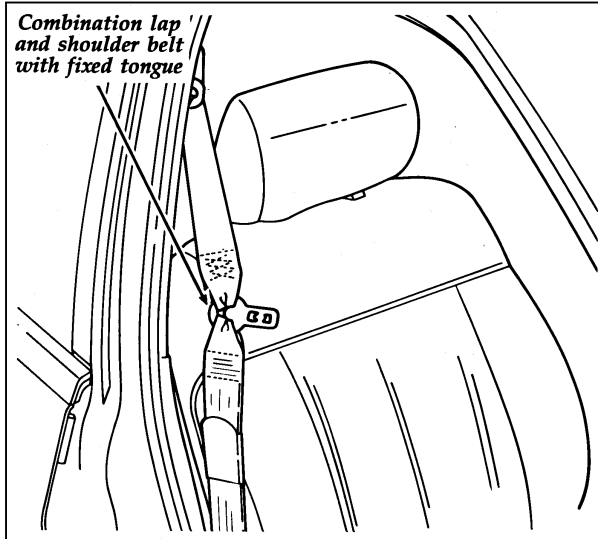

**Combination lap and shoulder belt with a fixed tongue
(available only on Canadian vehicles)**

Rear Seat Entry (Canadian 2-door hatchback models)

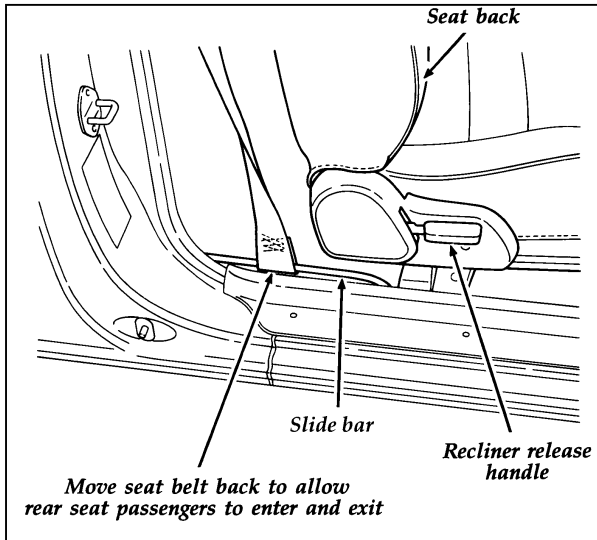

Rear seat entry

The slide bar on the safety belt system is designed to make it easier to enter and exit from the rear seat and to help front seat passengers reach the belt. To enter the rear seat:

- Move the safety belt out of the way with the slide bar. (The belt should be at the front end of the slide bar when the belt is in use.)
- Enter the rear seat in front of the safety belt.

Rear Lap and Shoulder Belts

Your vehicle is equipped with rear seat safety belts containing a cinch tongue, and the rear outboard seat safety belts will have the following label:



Rear seat belt label

Before you fasten a combination lap and shoulder belt having a cinch tongue, you may have to lengthen the lap belt portion of it. To lengthen the lap belt, pull some webbing out of the retractor. While holding the webbing below the tongue, grasp the tip (metal portion) of the tongue parallel to the webbing and slide the tongue upward.

NOTE: If you grasp the tongue by the tongue cover to lengthen the belt, the tongue cover will grab the webbing, making it difficult to slide.

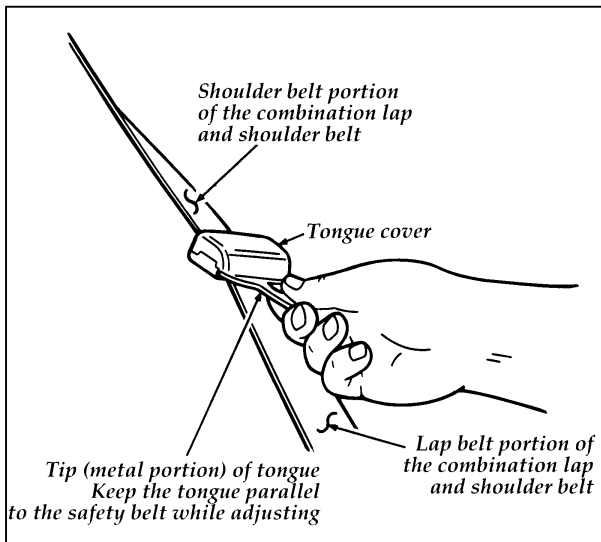

Adjusting the cinch tongue rear combination lap and shoulder belt

While in motion, the combination lap and shoulder belt adjusts to your movement. However, if you brake hard, turn hard, or if your vehicle receives an impact of 5 mph (8 km/h) or more, the lap and shoulder belt locks and helps reduce your forward movement.

To fasten a rear outboard belt, pull the combination lap and shoulder belt from the retractor so that the shoulder belt portion of the safety belt crosses your shoulder and chest. Be sure the belt is not twisted. If the belt is twisted, remove the twist. (For instructions on how to remove a twist, see the *How to Untwist or Unjam a Safety Belt Retractor* section in this chapter.) Insert the belt tongue into the proper buckle for your seating position until you hear a snap and

feel it latch. Make sure the tongue is securely fastened to the buckle. Adjust the lap belt portion of the safety belt by pulling up on the shoulder belt until the lap belt fits snugly and as low as possible around your hips.



The rear lap and shoulder belt fastened

⚠ WARNING

Front and rear seat occupants, including pregnant women, should wear safety belts for optimum protection in an accident.

⚠ WARNING

Use the shoulder belt on the outside shoulder only. Never wear the shoulder belt under the arm. Never swing it around the neck over the inside shoulder. Never use a single belt for more than one person. Failure to follow these precautions could increase the risk and/or severity of injury in a collision.

Due to folding rear seats, sometimes the buckles and tongues toward the center of the vehicle may be hidden by the rear edge of the seat cushion. Pull them out so they will be accessible.

To unfasten the belt

1. Push the release button on the buckle. This allows the tongue to unlatch from the buckle.

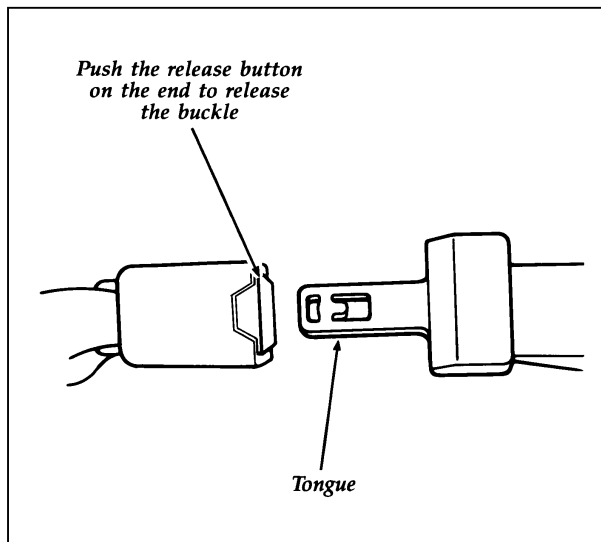

Unfastening the safety belts for the center seating position

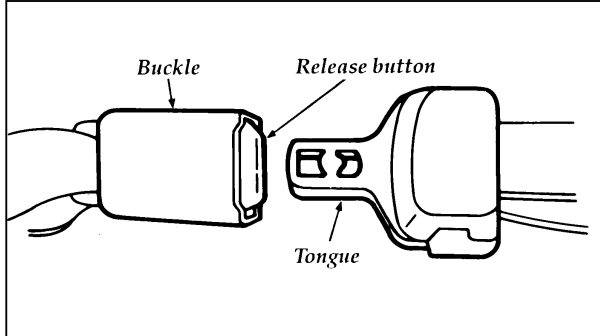

Unfastening the outboard rear lap/shoulder belt

2. While the belt retracts, guide the tongue to its original position to prevent it from striking you or the vehicle.

Instructions for securing child safety seats with rear manual lap and shoulder safety belts with cinch tongues are provided later in this chapter also.

How to Untwist or Unjam a Safety Belt Retractor

If you should jam the lap belt retractor by allowing the belt to retract when it is twisted, you can free the webbing with this procedure.

1. Pull on the belt with both hands to tighten it on the retractor spool.
2. Feed the belt back into the retractor until it is completely retracted. Repeat previous step if necessary.
3. Pull the belt out of its holder as far as it will go and untwist the belt or remove the object that is jamming the belt. Let the belt retract.
4. Then, pull the belt out and let it retract several times to make sure that the belt works properly.

Procedure to Correct a Twisted Safety Belt at the “D” Ring (if so equipped) Front and/or Rear Outboard Seating Positions

NOTE: The restraint system shown in the following figures may be different than the restraint system in your vehicle. However, use these figures and this procedure to correct a twisted safety belt at any outboard seating position that has a “D” ring.

NOTE: The following illustrations show the front driver’s seat safety belt. Your vehicle may not have a “D” ring at the indicated position.

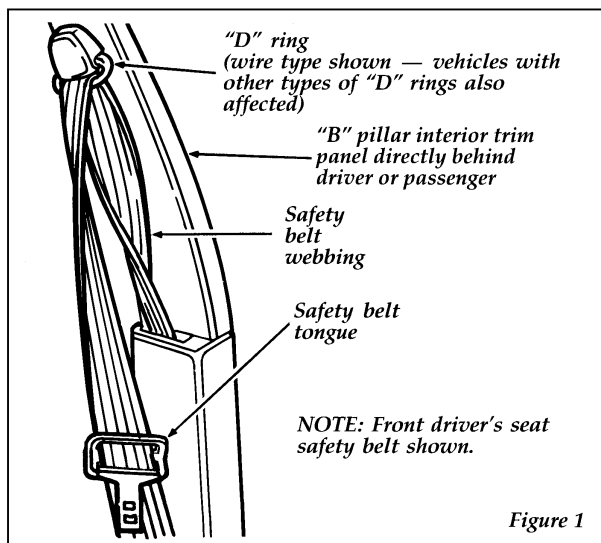

1. Grasp the belt webbing at the "D" ring. See Figure 2.

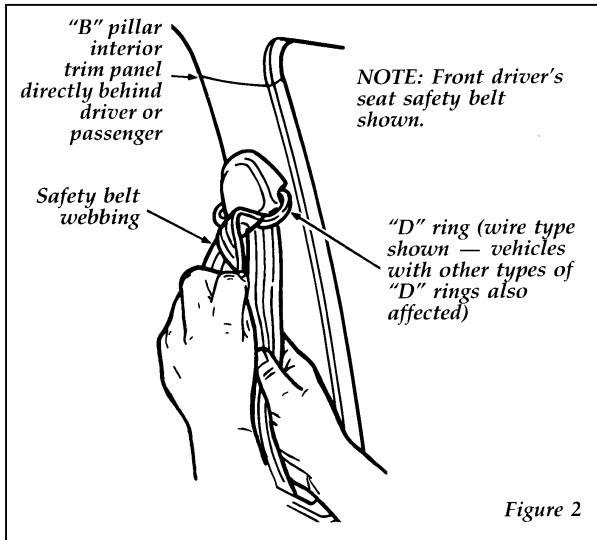

2. Rotate and fold the belt webbing over itself as required to remove the twist.
3. Feed the folded portion of the belt through the "D" ring.

4. When completed, the safety belt should look like Figure 3.

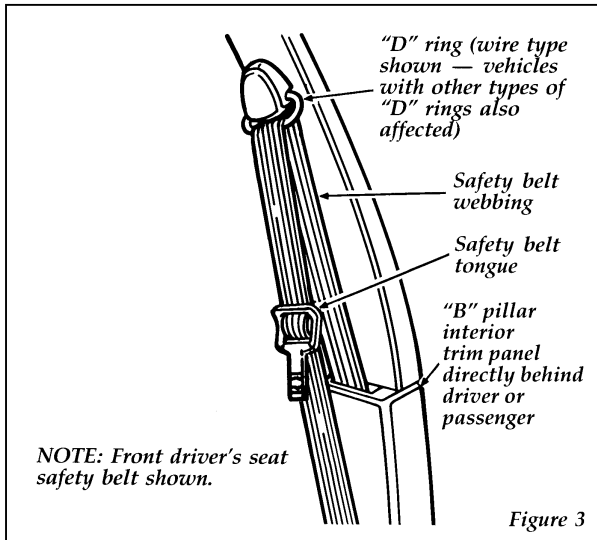

Procedure to Correct a Rotated Tongue on the Safety Belt (Front and/or rear outboard seating positions)

NOTE: The restraint system shown in the following figures may be different than the restraint system in your vehicle. However, use these figures and this procedure to correct a rotated tongue on the safety belt at any seating position that has a "D" ring.

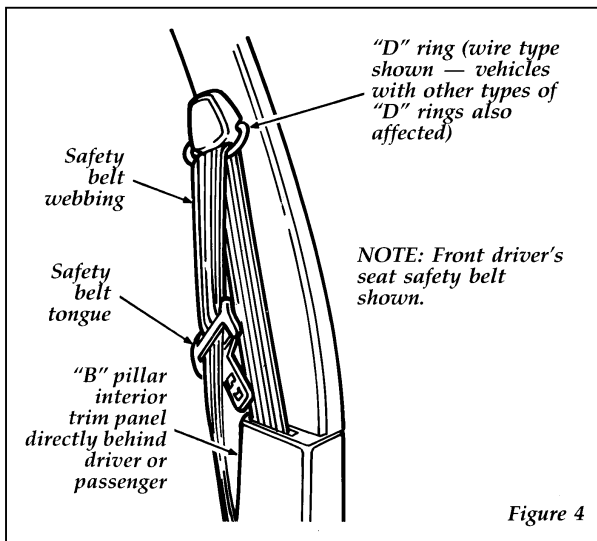

1. Grasp the belt tongue and pull down on the belt webbing closest to you to form a loop through the upper (narrow and longer) slot in the tongue. See Figure 5.

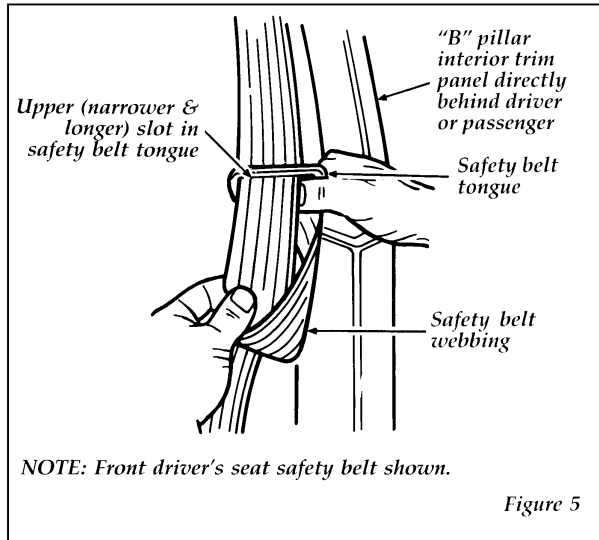

2. Working within the upper slot, rotate and fold the belt webbing over itself as required to remove the twist.
3. Pull the excess belt webbing back through the upper slot in the tongue.

- Repeat the above steps to complete the removal of the twist at the lower (wider and shorter) slot in the tongue. See Figure 6.

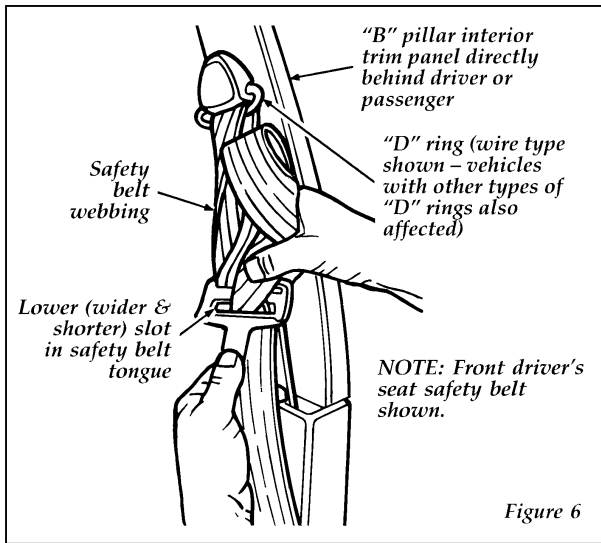

- When completed, the safety belt should look like Figure 3.

Rear Lap Belt

⚠ WARNING

The lap belts should fit snugly and as low as possible around the hips, not around the waist.

⚠ WARNING

Be sure the lap belt is fitted snugly and as low as possible around the hips, not around the waist. Failure to do so may increase the risk of injury in the event of a collision.

Before you fasten your lap belt, you may need to lengthen it.

To lengthen the belt, position the belt tongue at a right angle to the belt. Pull the belt tongue over your lap until it reaches the buckle.

To fasten the belt, pull the belt across your hips and insert the tongue into the correct buckle on your seat until you hear a snap and feel it lock. Make sure the buckle is securely fastened.

Adjust the belt so that it fits snugly around your hips, as low as possible.

If you need to lengthen the belt, unfasten it and repeat the procedure above. If you need to shorten the belt, pull on the loose end of the webbing.

To unfasten the belt, push the release button on the end of the buckle. This allows the tongue to unlatch from the buckle. Because the center lap belt does not have a retractor, it should be shortened and fastened when not in use.

Safety Belt Extension Assembly

For some people, the safety belt may be too short even when it is fully extended. You can add about eight inches (20 cm) to the belt length with a safety belt extension assembly. Safety belt extensions are available from your dealer.

Use only extensions manufactured by the same supplier as the safety belt. Manufacturer identification is located at the end of the webbing on the label. Also, use the safety belt extension only if the safety belt is too short for you when fully extended. Do not use extension to change the fit of the shoulder belt across the torso.

 WARNING
--

Failure to follow these instructions will affect the performance of the safety belts and increase the risk of personal injury.

Safety Belt Maintenance

Check the safety belt systems periodically to make sure that they work properly and are not damaged.

All safety belt assemblies, including retractors, buckles, front seat belt buckle support assemblies (slide bar) (if equipped), child safety seat tether bracket assemblies (if equipped), and attaching hardware, should be inspected after any collision. Ford recommends that all safety belt assemblies used in vehicles involved in a collision be replaced. However, if the collision was minor and a qualified technician finds that the belts do not show damage and continue to operate properly, they do not need to be replaced. Safety belt assemblies not in use during a collision should also be inspected and replaced if either damage or improper operation is noted.

Cleaning the Safety Belts

Clean the safety belts with any mild soap solution that is recommended for cleaning upholstery or carpets. Do not bleach or dye the belt webbing because this may weaken it.

Air Bag Supplemental Restraint System (SRS)

The driver and right front passenger air bag are Supplemental Restraint Systems (SRS), provided at these seating positions in addition to the lap/shoulder belt and are designed to supplement the protection provided to properly belted occupants in moderate to severe frontal collisions. The supplemental air bag system does not provide restraint to the lower body.

The Importance of Wearing Safety Belts

 WARNING
Safety belts must be worn by all vehicle occupants to be properly restrained and help reduce the risk of injury in a collision.

 WARNING
All occupants of the vehicle, including the driver, should always wear their safety belts, even when an air bag Supplemental Restraint System is provided.

There are four very important reasons to use safety belts even with an air bag system. Use your safety belts to:

- help keep you in the proper position (away from the air bag) when it inflates
- reduce the risk of harm in rollover, side or rear impact collisions, because an air bag is not designed to inflate in such situations
- reduce the risk of harm in frontal collisions that are not severe enough to activate the supplemental air bag
- reduce the risk of being thrown from your vehicle

The Importance of Being Properly Seated

In a collision, the air bag must inflate extremely fast to help provide additional protection for you. In order to do this, the air bag must inflate with considerable force. If you are not seated in a normal riding position with your back against the seatback, the air bag may not protect you properly and could possibly hurt you as it inflates.

⚠ WARNING
If a passenger is not properly seated and restrained, an inflating air bag could cause serious injury.

⚠ WARNING
Rear-facing infant seats should never be placed in the front seat.

In rear-facing infant seats, the infant's head is closer to the air bag. The force of the rapidly inflating air bag could push the top of the rear-facing seat against the vehicle seatback or center armrests (if so equipped), or center console (if so equipped). **REAR-FACING INFANT CARRIERS MUST ALWAYS BE SECURED IN THE REAR SEAT**, and other child safety seats and infant seats should be secured in the rear seat whenever possible.

Your vehicle is equipped with a right front passenger air bag. Air bags deploy with great force, faster than the blink of an eye. Front passengers, especially children and small adults, must never sit on the front edge of the seat, stand near the glove compartment of the instrument panel, or lean over near the air bag cover when the vehicle is moving. All occupants should sit with their backs against the seatback, move the seat to the most rearward position if possible and use the safety belts. Children weighing less than 40 lbs. (18 kg) always should use child or infant seats.

 **WARNING**

When using forward-facing child seats move the passenger seat as far back from the instrument panel as possible. NEVER SECURE REAR-FACING INFANT SEATS IN THE FRONT SEAT.

The force of the rapidly inflating passenger air bag could push the top of the rear-facing seat against the vehicle seatback, armrests or console. Rear-facing infant seats must always be secured in the rear seat.

⚠️ WARNING

Do not place objects or mount equipment on or near the air bag cover on the steering wheel or in front seat areas that may come in contact with a deploying air bag. Failure to follow this instruction may increase the risk of personal injury in the event of a collision.

How the Air Bag Supplemental Restraint System Operates

The Air Bag Supplemental Restraint System consists of the Driver and Passenger air bags, impact sensors, a system diagnostic module, a readiness light and tone, and the electrical wiring which connects the components. The diagnostic module monitors its own internal circuits and the supplemental air bag electrical system readiness, including crash sensors, the system wiring, the air bag readiness light, air bag backup power, and the supplemental air bag ignitors.

The driver air bag is in the center of the steering wheel. The front passenger seat air bag is located in the center section of the instrument panel ledge above the glove compartment. Both air bags are designed to stay out of sight until they are activated.

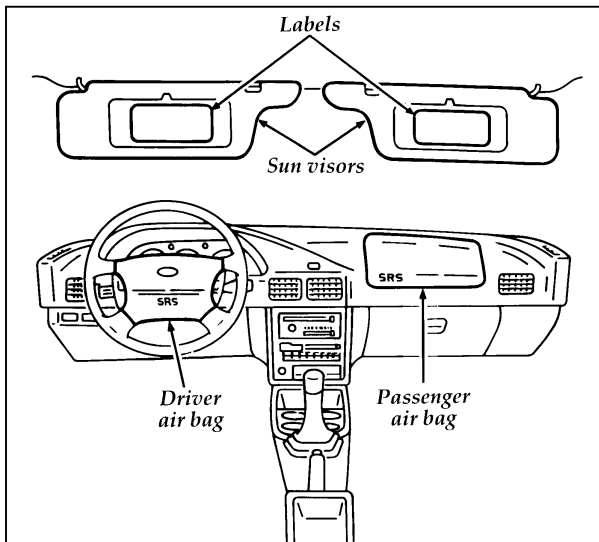

The location of the air bag and warning labels

If a collision occurs, the sensors sense the severity of the impact and activate the air bags if necessary. The air bag system is designed to deploy in frontal and front-angled collisions more severe than hitting a parked vehicle (of similar size and weight) head-on at about 28 mph (45 km/h). Because the system senses the crash severity rather than vehicle speed, some frontal collisions at speeds above 28 mph (45 km/h) will not inflate the air bag.

When the sensors activate the system, the air bags inflate rapidly, filling with non-toxic nitrogen gas in a fraction of a second. Immediately after inflation, the air bags deflate by releasing the nitrogen gas through vent holes. The whole process takes place in a matter of seconds.

⚠ WARNING

Air bag system components get hot after inflation. Do not touch them after inflation.



Inflated driver side air bag

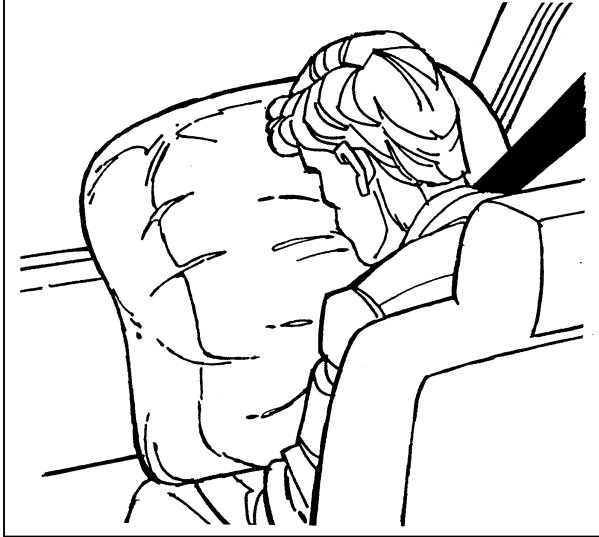

Inflated passenger side air bag

⚠ WARNING

If the air bag is inflated, THE AIR BAG WILL NOT FUNCTION AGAIN AND MUST BE REPLACED IMMEDIATELY. If the air bag is not replaced, the unrepaired area will increase the risk of injury in a collision.

To ensure that the air bag system will operate as intended in a crash, the system is equipped with a diagnostic module, which controls a readiness lamp and a warning tone. The diagnostic module monitors its own circuits, the air bag electrical system, the air bag readiness light, the air bag power, and the air bag inflators.

The air bag system uses a readiness light on the instrument cluster or a tone to indicate the condition of the system. When you turn the ignition to the ON position, this light will

illuminate for approximately six (6) seconds and then turn off. This indicates that the system is operating normally. **NOTE:** Maintenance of the air bag system is not required.

A problem with the system is indicated by one or more of the following:

- the readiness light will either flash or stay lit,
- or it will not light immediately after ignition is turned on,
- or a group of five beeps will be heard. The tone pattern will repeat periodically until the problem and light are repaired.

If any of these things happen, have the air bag system serviced at your Ford or Lincoln-Mercury dealer immediately. Unless serviced, the air bag Supplemental Restraint System may not function properly in the event of a collision.

 **WARNING**

Do not attempt to service, repair, or modify the Air Bag Supplemental Restraint System or its fuses. See your Ford or Lincoln-Mercury dealer.

Disposal of air bags or air bag equipped vehicles

For disposal of air bags or air bag equipped vehicles, see your local Ford or Lincoln-Mercury dealer. Air bags **MUST** be disposed of by qualified personnel.

Service and information labels

Service and information labels are attached to the sun visor, on the headliner above the driver's sun visor (Canadian vehicles), and near the radiator support in the engine compartment.

Safety Restraints for Children

In the U.S. and Canada, you are required by law to use safety restraints for children. If small children ride in your vehicle — this generally includes children who are four years old or younger and who weigh 40 pounds (18 kg) or less — you must put them in safety seats that are made specially for children. Safety belts alone do not provide maximum protection for these children. Check your local and state laws for specific requirements.

⚠ WARNING

Never let a passenger hold a child on his or her lap while the vehicle is moving. The passenger cannot protect the child from injury in a collision.

⚠ WARNING

To prevent the risk of injury, make sure children sit where they can be properly restrained.

⚠ WARNING

Do not allow people to ride in any area of your vehicle that is not equipped with seats and safety belts.

⚠ WARNING

Be sure everyone in your vehicle is in a seat and using a safety belt properly.

⚠️ WARNING

It is extremely dangerous to ride in a cargo area, inside or outside of a vehicle. In a collision, people riding in these areas are more likely to be seriously injured or killed.

When possible, put children in the rear seat of your vehicle. Accident statistics suggest that children are safer when properly restrained in the rear seating positions than in the front seating positions.

⚠️ WARNING

Carefully follow all of the manufacturer's instructions included with the safety seat you put in your vehicle. If you do not install and use the safety seat properly, the child may be injured in a sudden stop or collision.

⚠️ WARNING

Never leave a child unattended in your vehicle.

⚠️ WARNING

Safety belts and seats can become hot in a vehicle that has been closed up in sunny weather; they could burn a small child. Check seat covers and buckles before you place a child anywhere near them.

Safety Seats for Children

Use a safety seat that is recommended for the size and weight of the child. Always follow the safety seat manufacturer's instructions when installing and using the safety seat.

Ford recommends the use of a child safety seat having a top tether strap. Install the child safety seat in a seating position which is capable of providing a tether anchorage. For more information on top tether straps see *Attaching Safety Seats With Tether Straps* in this chapter.

When installing a child safety seat, be sure to use the correct safety belt buckle for that seating position, and make sure the tongue is securely fastened in the buckle.

Your vehicle is equipped with a right front passenger air bag. Air bags deploy with great force, faster than the blink of an eye. Front passengers, especially children and small adults, must never sit on the front edge of the seat, stand near the glove compartment of the instrument panel, or lean over near the air bag cover when the vehicle is moving. All occupants should sit with their backs against the seatback, move the seat to the most rearward position if possible and use the safety belts. Children weighing less than 40 lbs. (18 kg) always should use child or infant seats.

 **WARNING**

When using forward-facing child seats move the passenger seat as far back from the instrument panel as possible. NEVER SECURE REAR-FACING INFANT SEATS IN THE FRONT SEAT.

The force of the rapidly inflating passenger air bag could push the top of the rear-facing seat against the vehicle seatback, armrests or console. Rear-facing infant seats must always be secured in the rear seat.

All child restraint systems are designed to be secured in vehicle seats by lap belts or by the lap portion of a lap-shoulder belt.

⚠ WARNING

If you do not properly secure the safety seat, the child occupying the seat may be injured during a collision or sudden stop. An unsecured safety seat could also injure other passengers.

⚠ WARNING

Carefully follow all of the manufacturer's instructions included with the safety seat you put in your vehicle. If you do not install and use the safety seat properly, the child may be injured in a sudden stop or collision.

⚠ WARNING

Always keep the buckle release button pointing upward and away from the child seat, with the tongue between the child seat and the release button as shown in the following illustration. Failure to follow these instructions could result in accidental unbuckling of the safety belt if the child safety seat hits the release button. Release of the safety belt could result in serious injuries.

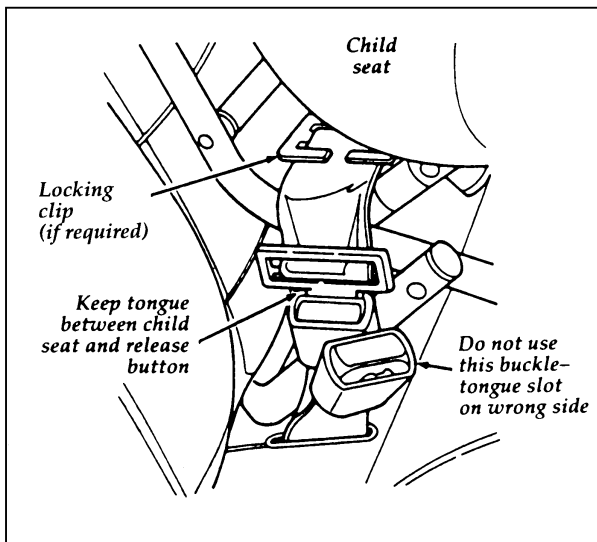

Safety belt buckle placement for child seats

Installing the Child Safety Seat in the Front Seat with a Locking Clip (Canadian 2-door vehicles only)

If your vehicle is not equipped with a dual locking mode retractor for the front passenger, the lap belt will have the following label:

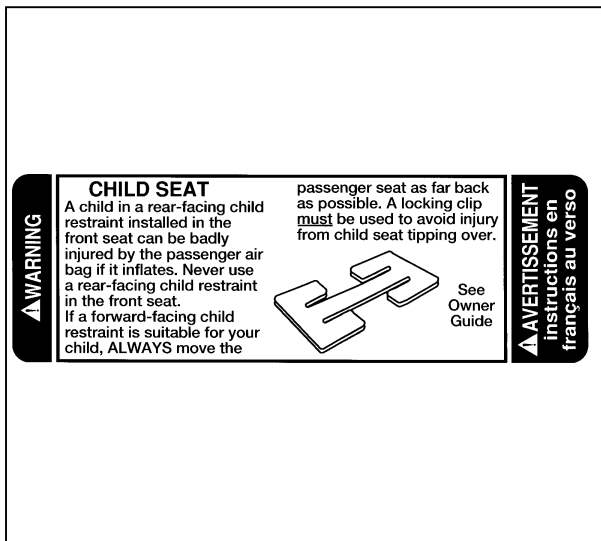
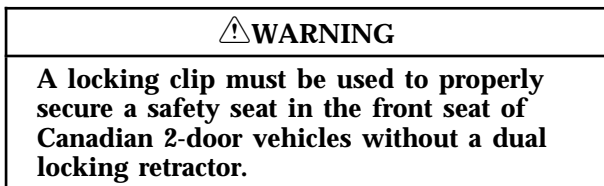

Figure 1: Locking clip label

A locking clip must be used to properly secure a child seat in a front seat not equipped with a dual locking mode retractor.



⚠ WARNING

If you do not use a locking clip, injuries could result from the child seat tipping over during normal braking or turning.

To install the locking clip

1. Thread the belt webbing through the child seat according to the child seat's manufacturer's instructions.
2. Buckle the safety belt.

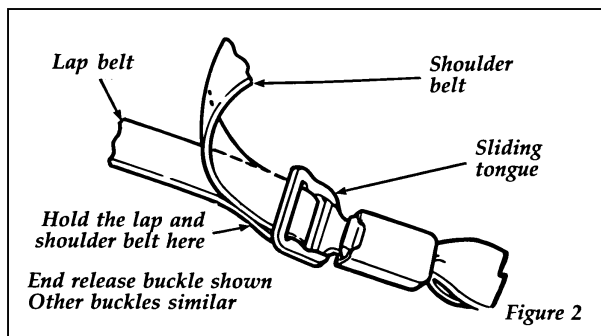

3. Pull on the shoulder portion of the belt to make the lap portion fit snugly. Keeping the lap belt snug, hold the lap and shoulder belt portions of the webbing together next to the sliding tongue and unbuckle the seat belt. See Figure 2.

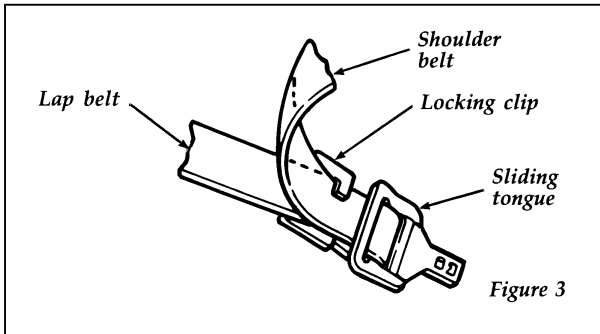

4. Slide either corner of the locking clip slot closest to the tongue over both layers of webbing. See Figure 3.

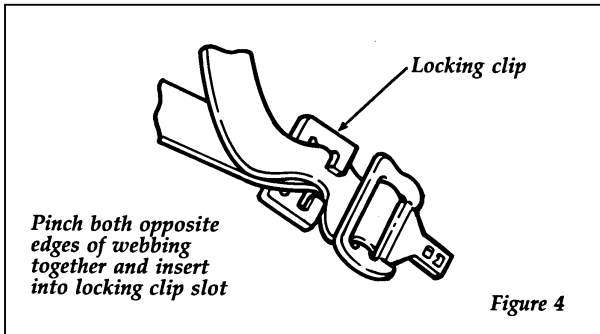

5. Pinch both opposite edges of webbing together and insert them into the locking clip slot. See Figure 4.

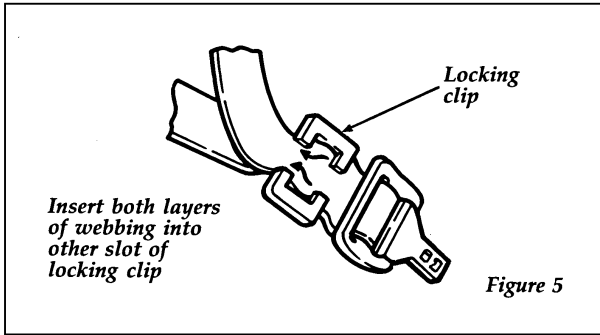

6. Pinch both layers of webbing together and insert into other slot of locking clip. See Figure 5.

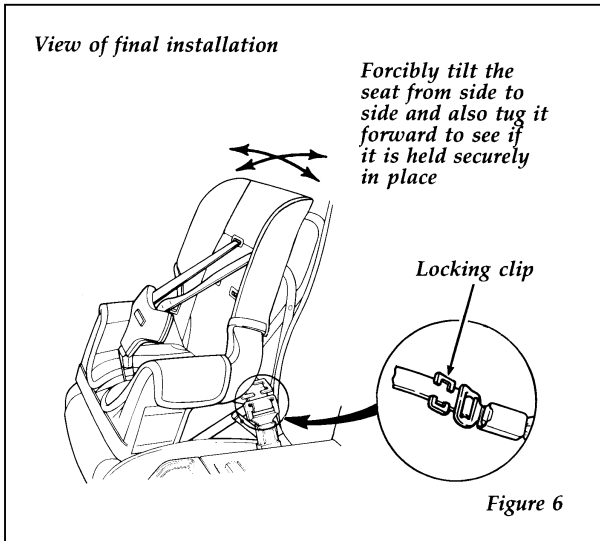

7. Re-buckle belt. Forcibly tilt the child seat from side to side and also tug it forward to see if it is held securely in place. See Figure 6. If excessive movement occurs, repeat steps 2 through 7 or properly install child seat in a different seating position in the vehicle.

⚠ WARNING

Once you have attached the safety seat, test the seat before you place the child in it. Tilt the seat from side to side. Also try to tug the seat forward. Check to see if the belt holds the seat in place. If the lap belt is too loose, tighten it by moving the locking clip, or put the safety seat in another seat and test it again. If the safety seat is not anchored properly, the risk of a child being injured in a collision or sudden stop greatly increases. Reclining seatbacks should be in the most upright position for use with child safety seats.

Installing Safety Seats in the Front Seat (U.S. vehicles and Canadian 4-door sedan, 4-door hatchback and wagon vehicles)

Your vehicle is equipped with a dual locking mode retractor on the front lap belt (U.S. vehicles) or the lap belt portion of the front lap/shoulder belt (Canadian vehicles). The lap belt will have the following label:

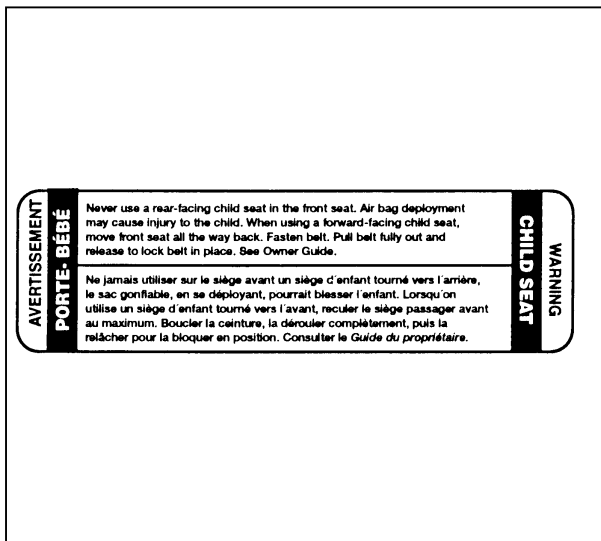

The automatic locking mode **must be used** when installing a child seat in the front passenger seat.

If you choose to install a forward-facing child safety seat in a front seat with a dual locking mode retractor:

1. Move the front passenger seat as far back as possible.
2. Position the child seat in the front passenger seat of the vehicle.

3. Follow the child seat manufacturer's instructions. Route the lap or lap/shoulder belt through the child seat and insert the belt tongue into the buckle until you hear and feel the latch engage.

Be sure to follow the manufacturer's instructions for belt routing.

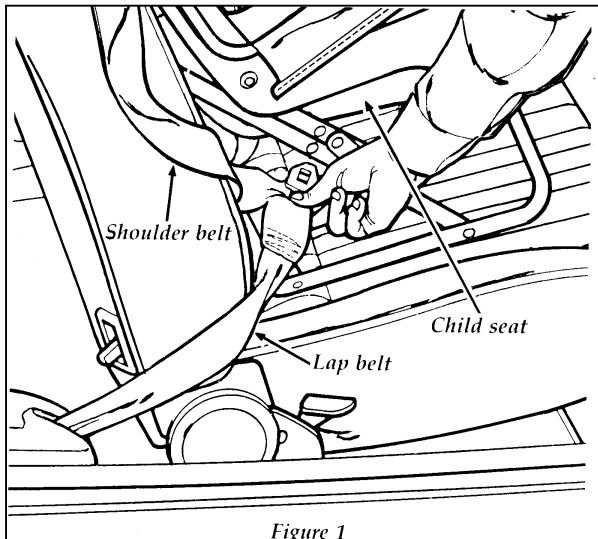
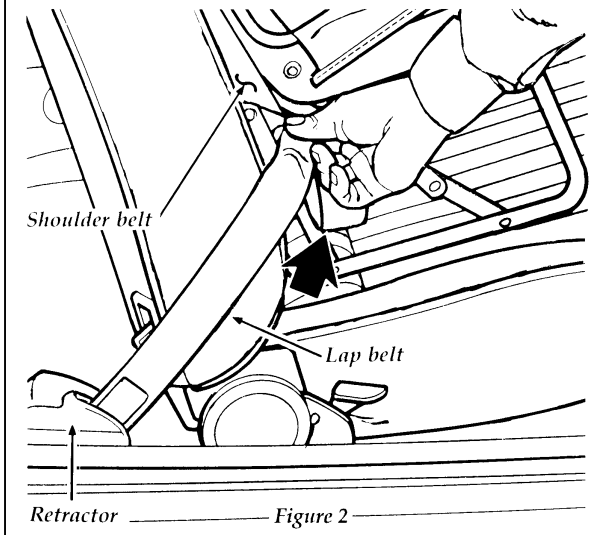

Figure 1

Routing the lap or lap/shoulder belt

4. Grasp the lap portion of the belt below the child seat label. Pull upward until all of the belt is extracted and a click is heard. At this time, the lap belt retractor is in the automatic locking mode (child seat restraint mode).



Setting the automatic locking mode

5. Allow the belt to retract. A clicking sound will be heard as the belt retracts. This indicates the retractor is in the automatic locking mode. Push down on the child seat while you pull down on the belt to remove any slack in the belt.

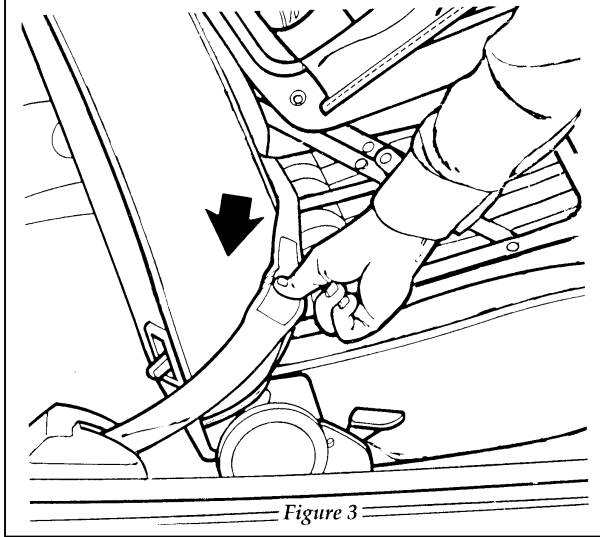

Removing slack from the belt

6. Before placing the child in the child seat, forcibly tilt the seat from side to side, and also tug it forward to make sure that the seat is securely held in place.

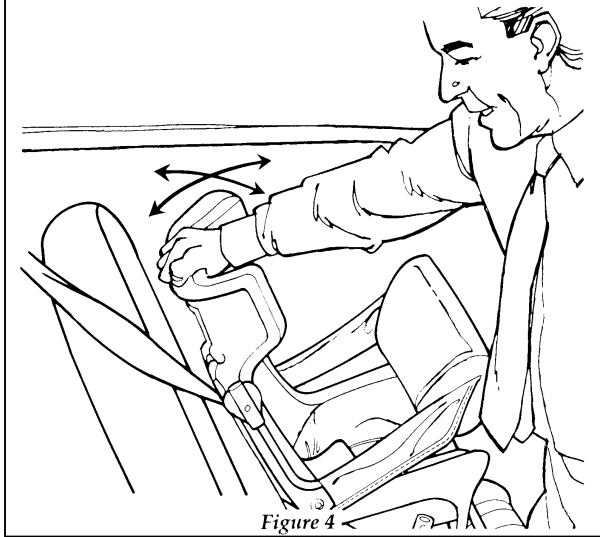

Figure 4

Checking that the seat is secure

7. Double check that the retractor is in the automatic locking mode. Try to pull more belt out of the retractor, if you cannot, the belt is in the automatic locking mode.
8. Check to make sure that the child seat is properly secured prior to each use. If the lap belt is not locked, repeat steps 4 through 7.

NOTE: When the safety belt is unbuckled and allowed to retract completely, the retractor will switch to the vehicle sensitive (emergency) locking mode. See the detailed instructions under *Front Passenger Lap Belt Retractor* in this chapter.

Installing Child Safety Seats in the Front Passenger Seating Position (Canadian 2-door Hatchback vehicles)

For vehicles equipped with a dual locking mode retractor, use the following procedure.

If you choose to install a child safety seat or infant carrier in the front seating positions, move vehicle seat as far back as possible.

1. Position the child seat in the center of the passenger seat.
2. Pull down on shoulder belt, then grasp shoulder belt and lap belt together. See Figure 1.

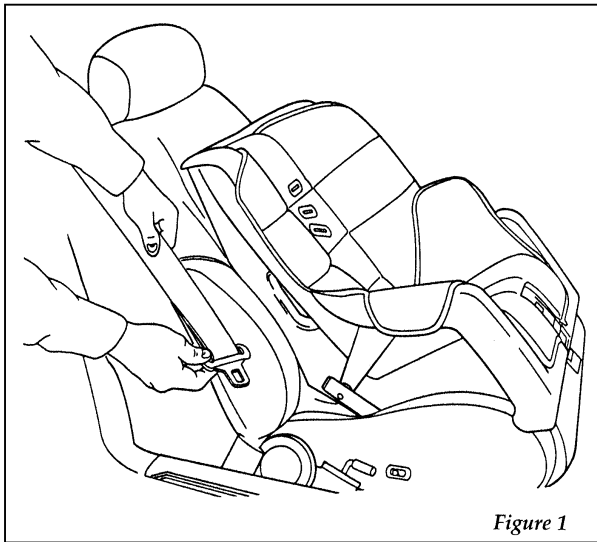

Pulling out belt webbing

3. While holding the shoulder and lap belt portions together, route the tongue through the child seat according to the child seat manufacturer's instructions. See Figure 2. Be sure that the belt webbing is not twisted.

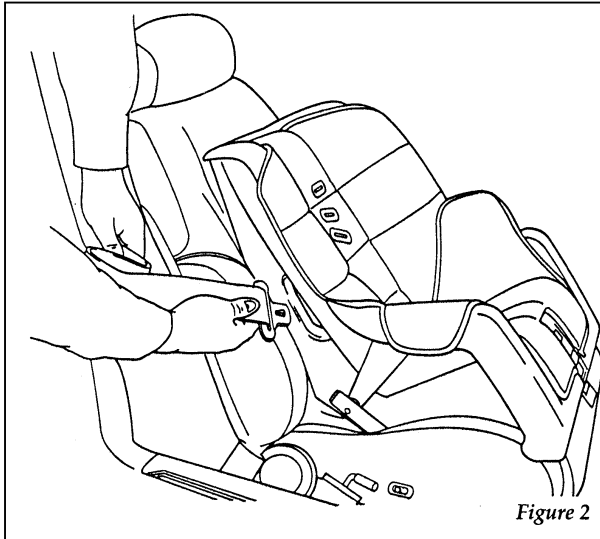

Routing the lap/shoulder belt

4. Insert the belt tongue into the buckle for that seating position until you hear and feel the latch engage. See Figure 3. Make sure tongue is latched securely to buckle by pulling on tongue.

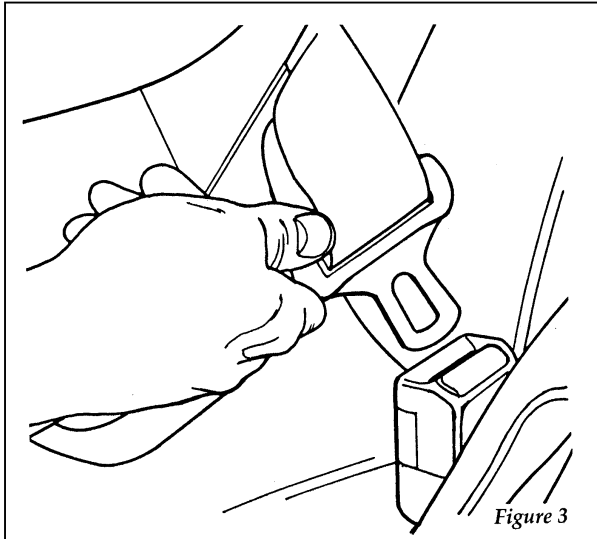

Buckling the belt

5. Grasp the shoulder portion of the belt and pull downward until all of the belt is extracted and a click is heard. At this time, the retractor is in the automatic locking mode (child seat restraint mode). See Figure 4.

NOTE: The dual-locking mode retractor must be in the automatic locking mode to properly restrain a child.

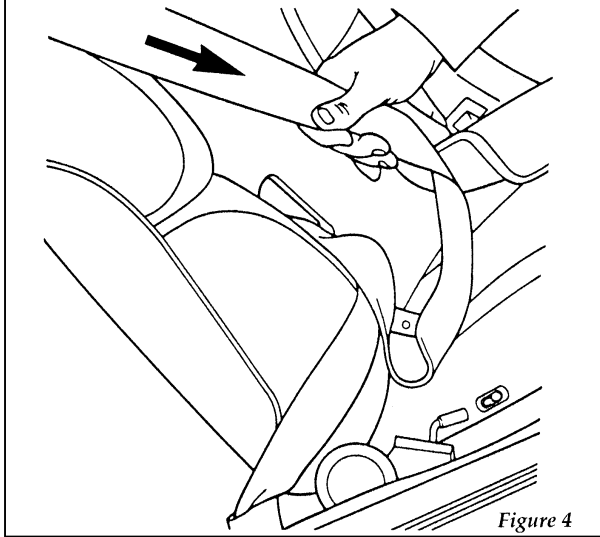

Figure 4

Setting the retractor to automatic locking mode

6. Allow the belt to retract. Pull up on the shoulder webbing. A clicking sound will be heard as the belt retracts. This indicates the retractor is in the automatic locking mode. Push down on the child seat while you pull up on the belt to remove any slack in the belt. See Figures 5 and 6.

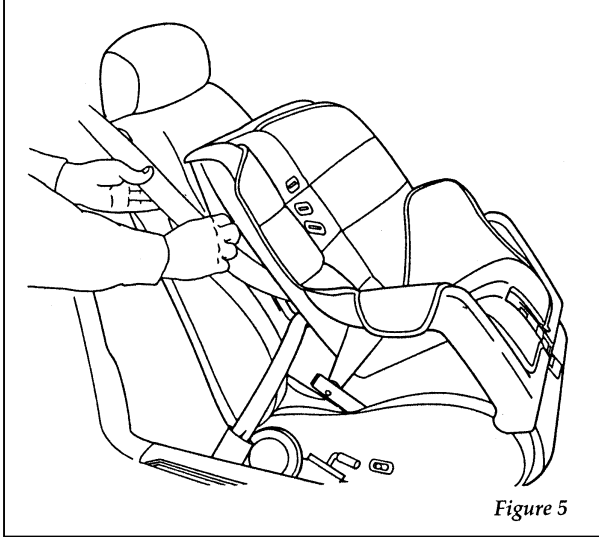

Figure 5

Allowing shoulder belt to retract

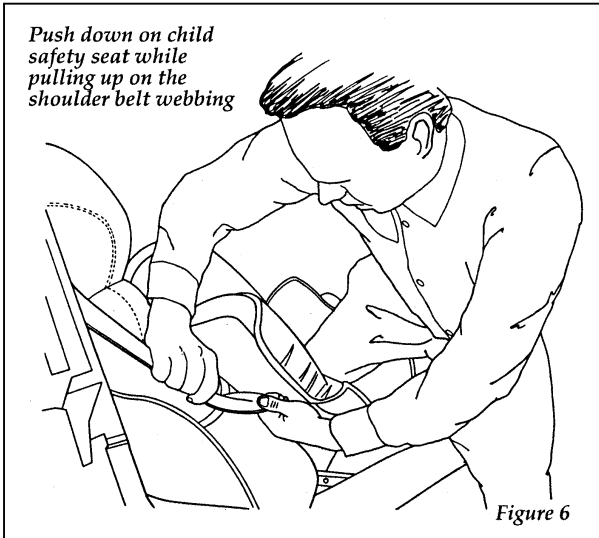
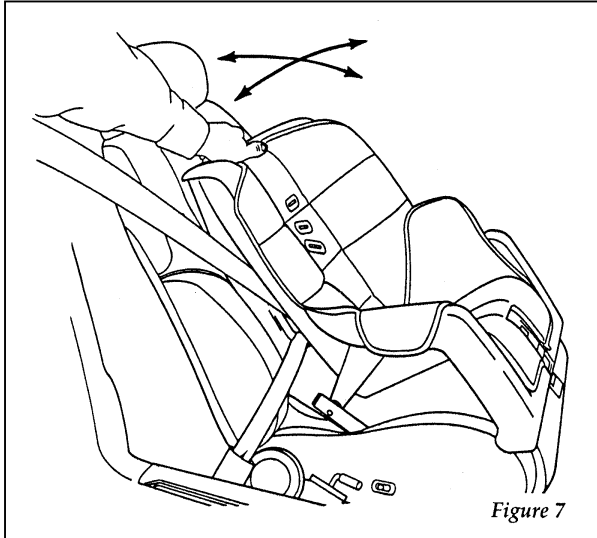

Figure 6

Removing slack from belt

7. Before placing the child in the child seat, forcibly tilt the seat from side to side, and tug it forward to make sure that the seat is securely held in place. See Figure 7.



Checking that the seat is secure

8. Double check that the retractor is in the automatic locking mode. Try to pull more belt out of the retractor. If you cannot, the belt is in the automatic locking mode. See Figure 8.

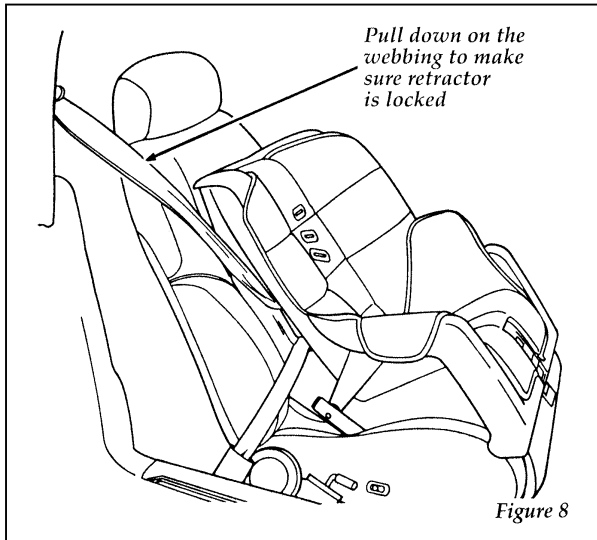

Checking the retractor

9. Check to make sure that the child seat is properly secured prior to each use. If the retractor is not locked, repeat steps 4 through 7.

To remove the retractor from automatic lock mode, allow webbing to retract fully to its stowed position and the retractor will automatically switch back to the vehicle sensitive locking mode for normal adult usage.

Installing Child Safety Seats at the Rear Outboard Seating Positions (For lap and shoulder belts with cinch tongues)

If you install a child safety seat in a rear outboard seating position with a combination lap and shoulder belt with cinch tongue, use the following procedure:

1. Grasp the belt webbing below the tongue and pull as much of the belt out of the retractor as possible. Hold the belt out. See Figure 1.

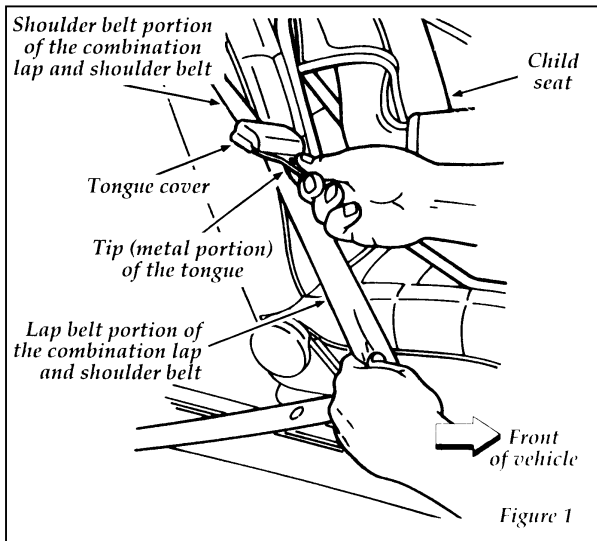

Pulling out belt webbing

NOTE: The belt webbing below the tongue is the lap belt portion of the combination lap and shoulder belt, and the belt webbing above the tongue is the shoulder belt portion of the combination lap and shoulder belt.

2. With your other hand, grasp the tip (metal portion) of the tongue (not the cover) and slide the tongue up the webbing as far as it will go. See Figure 1. Release the tongue, but do not let go of the lap belt webbing.
3. While holding the lap belt webbing in one hand, use your other hand to pinch the tip (metal portion) of the tongue and belt webbing together and again pull out as much of the belt as possible. Then, let go of the lap belt webbing.
4. Route the tongue and webbing through the child seat according to the child seat manufacturer's instructions. See Figure 2. Be sure that the belt webbing is not twisted. If so, remove the twist. (For instructions on how to remove a twist, see the *Procedure to Correct a Rotated Tongue on the Safety Belt* section in this chapter.)

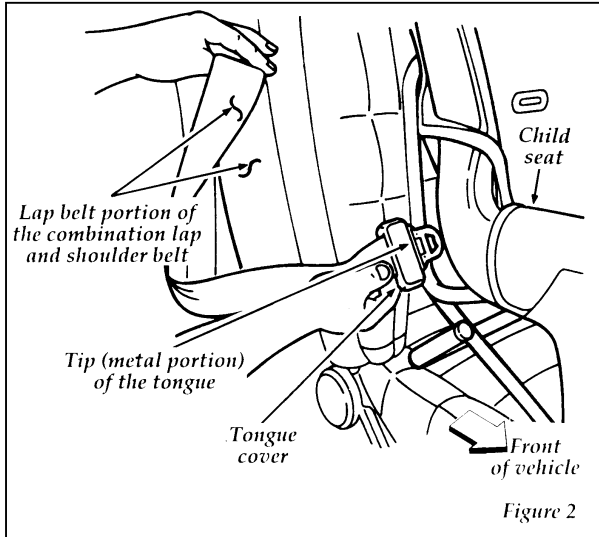

Routing the lap/shoulder belt

5. Insert the belt tongue into the proper buckle for the seating position until you hear a snap and feel it latch. Make sure the tongue is securely fastened to the buckle. Let go of the belt webbing. See Figure 3.

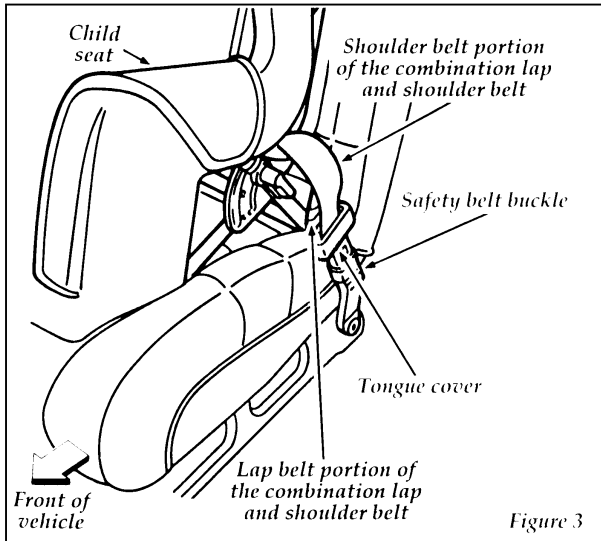
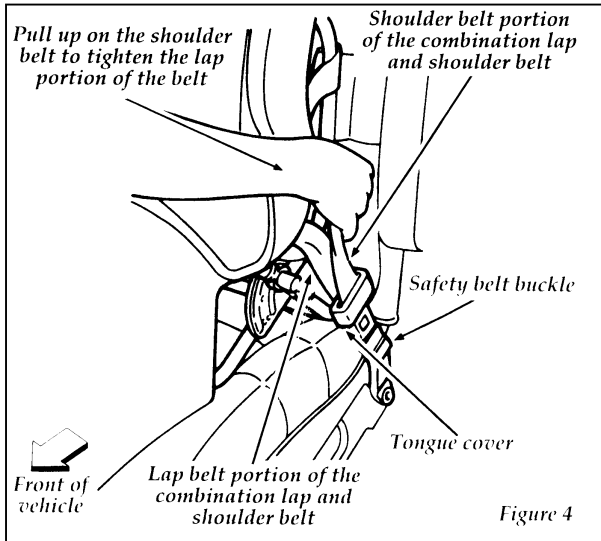

Figure 3

Buckling the belt

6. Push down on the child seat and, at the buckle, pull up on the shoulder belt to tighten the lap belt portion of the combination lap and shoulder belt. See Figure 4.



Tightening lap portion of belt

7. From outside the vehicle, grasp and pull on the shoulder belt portion of the combination lap and shoulder belt that secures the child safety seat in the vehicle. See Figure 5.

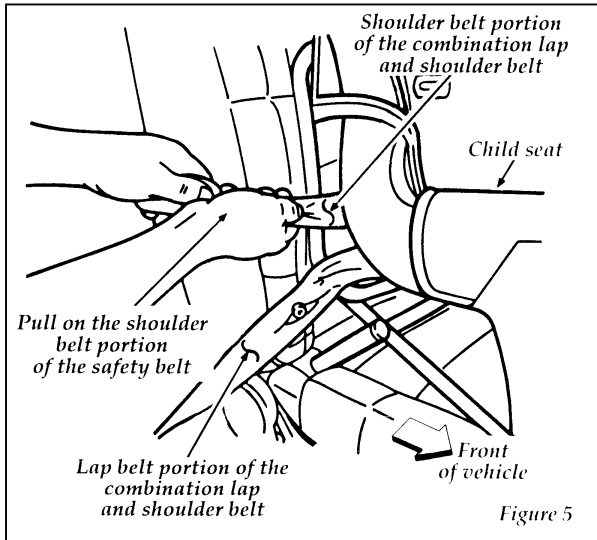

Tightening shoulder portion of belt

8. Forcibly tilt the child seat from side to side and tug the seat forward to ensure that the seat is held securely in place. See Figures 6 and 7. If the child seat moves excessively, repeat steps 6 through 8 or properly install the child seat in a different seating position.

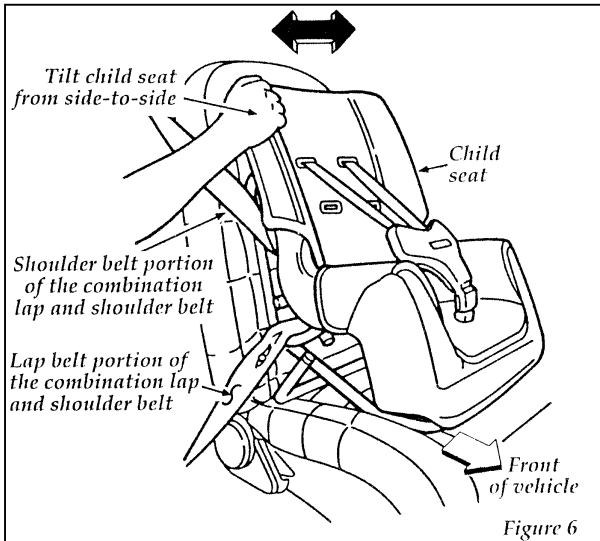

Checking that the seat is secure

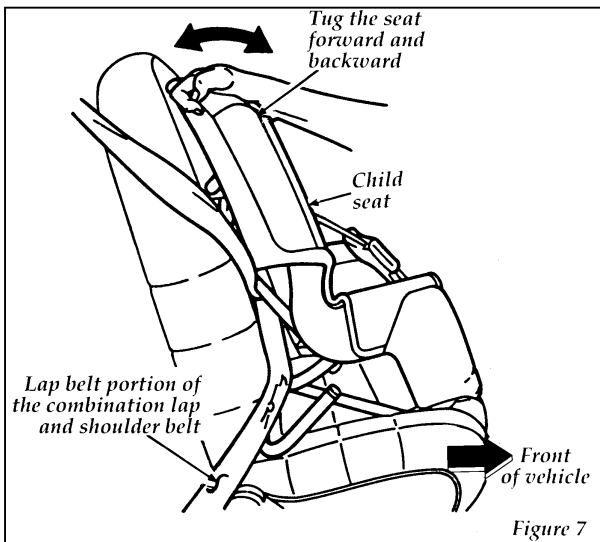

Checking that the seat is secure

9. Check from time to time to be sure that there is no slack in the lap/shoulder belt. The shoulder belt must be snug to keep the lap belt tight during a collision.

Installing a Child Safety Seat at the Rear Center Seating Position (For all vehicles)

1. Lengthen the lap belt. To lengthen the belt, hold the belt tongue at a right angle to the belt webbing. Slide the tongue up the webbing.
2. Place the child safety seat in the center seating position.
3. Route the tongue and webbing through the child seat according to the child seat manufacturer's instructions.
4. Insert the belt tongue into the proper buckle for the center seating position until you hear a snap and feel it latch. Make sure the tongue is securely fastened to the buckle.
5. Push down on the child seat while pulling on the loose end of the lap belt webbing to tighten the belt.
6. Forcibly tilt the child seat from side to side and tug the seat forward to ensure that the seat is held securely in place. If the child seat moves excessively, repeat steps 5 through 6 or properly install the child seat in a different seating position.

Attaching Child Safety Seats with Tether Straps (For all vehicles)

Some manufacturers make safety seats that include a tether strap that goes over the back of the vehicle seat and attaches to an anchoring point. Other manufacturers offer the tether strap as an accessory. Contact the manufacturer of your child safety seat for information about ordering a tether strap.

If you use a tethered safety seat on one of the rear seats, you can anchor the strap to the appropriate tether anchor directly behind that seat position.

Front Seats

To install a tether from a child safety seat in the front seat:

1. Buckle the lap/shoulder belt (in the seat directly behind the front passenger seat in which the child safety seat will be installed).
2. Pull at the stored belt out of the rear seat retractor to switch the retractor to automatic locking mode.
3. Let the retractor wind up the slack from the lap/shoulder belt.
4. Install the child safety seat in the front seat. Refer to the previous section on *Installing Safety Seats*. Hook the tether strap hook around the webbing near the center of the shoulder portion of the locked lap/shoulder belt.
5. Tighten the tether strap.

Rear Seats

If you use a tethered safety seat on one of the rear seats, you can anchor the strap to the appropriate tether anchor directly behind that seat position.

Tether anchorage hardware (Canadian vehicles only)

All vehicles built for sale in Canada include a tether anchor hardware kit for use with Canadian child safety seats. Attachment holes (at each rear seating position) have been provided in your vehicle to attach the anchor hardware, if required. Additional kits can be obtained at no charge from any Ford or Lincoln-Mercury dealer.

Tether anchorage hardware (U.S. vehicles only)

Vehicles built for sale in the USA do not include a tether anchor hardware kit for use with child safety seats. However, attachment holes (at each rear seating position) have been provided in your vehicle to attach the tether anchor hardware. Tether anchor hardware kits can be obtained at no charge from any Ford or Lincoln-Mercury dealer.

Be sure to follow the child safety seat manufacturer's instructions.

 WARNING
Tighten the anchor according to specifications. Otherwise the safety seat may not be properly secured and the child may be injured in a sudden stop or collision.

Tether anchorage hardware

The 2-door hatchback, 4-door hatchback, and wagon models have tether anchors at the locations shown.

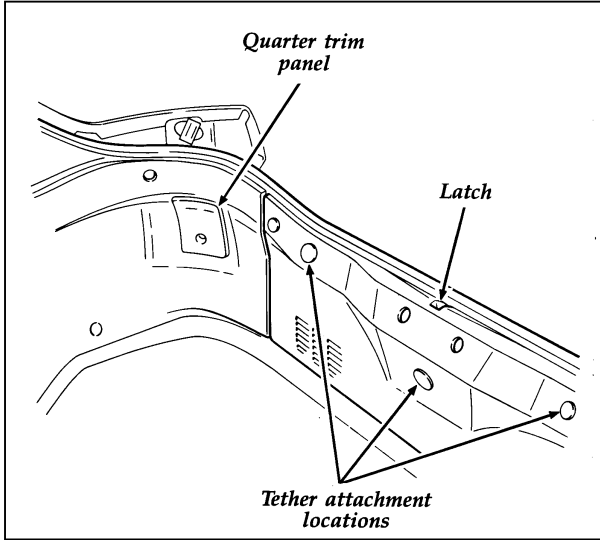

Tether attachment locations in the 2-door hatchback and 4-door hatchback models

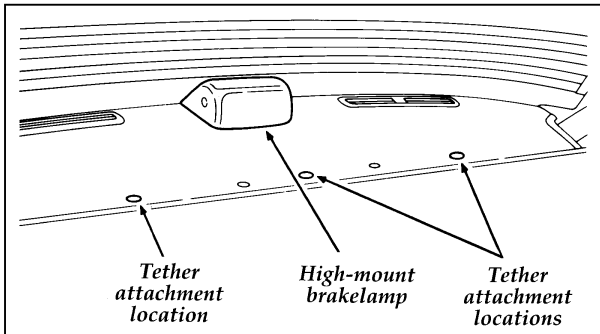

Tether attachment locations in the 4-door LX model

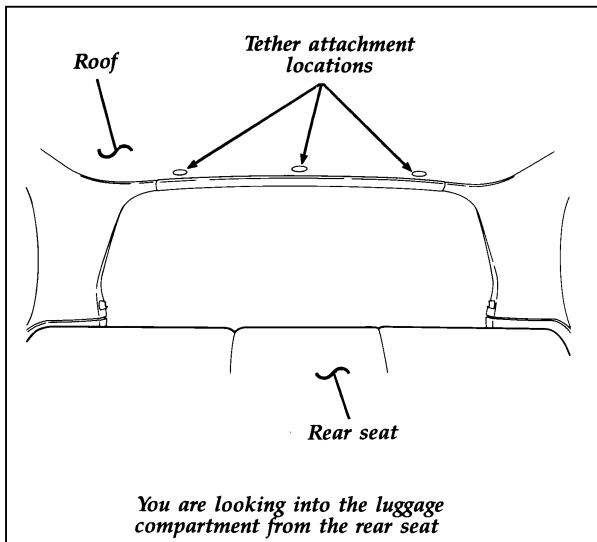

Tether attachment locations in the 4-door model

1. Find the plastic snap on covers for the tether anchors in the locations shown.
2. Use a screwdriver or coin to snap the covers off the anchor in a rearward and upward direction. Remove the covers completely.

NOTE: On the 4-door sedan model, holes have to be cut through the package tray (at the locations shown) to attach the tether anchors. The package tray trim panel has visible markings at these locations showing where to cut the holes (see the appropriate illustration). A sharp knife is recommended for cutting through the panel.

3. Snap the tether strap hook onto the tether anchor.

Built-In Child Seat (If Equipped)

The optional rear seat may include a built-in child seat. This child restraint is to be used **only** by children who are at least one year old, weigh between 20 and 60 pounds (9 and 27 kilograms) and whose shoulders (top) are below the shoulder harness slots. See Figure 1.

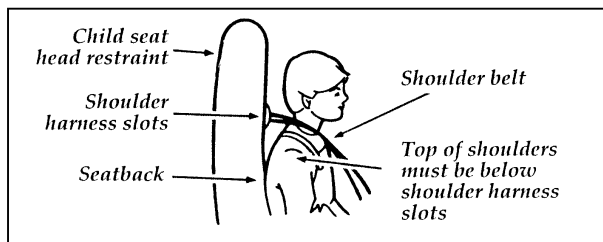

Figure 1: Proper child shoulder height

If your child is less than one year old or weighs less than 20 pounds (9 kilograms), **always** use a rear facing infant or convertible seat because a child of that size is not sufficiently developed to withstand crash forces in a front facing position. Follow the specific manufacturer's instructions for weight and height restrictions.

Children must be properly buckled before riding in the vehicle. It is the law in every state and province. This child seat conforms to all Federal/Canadian motor vehicle safety standards.

WARNING

The rear seatback must be fully locked before operating the child restraint system.

Ensure that the latch release buttons are in the full up (locked) positions on both sides of the seat.

When the latch release buttons are in the full up position (locked) and the built-in child seat is open, the rear seatback cannot be unlocked and folded down. See Figure 2.

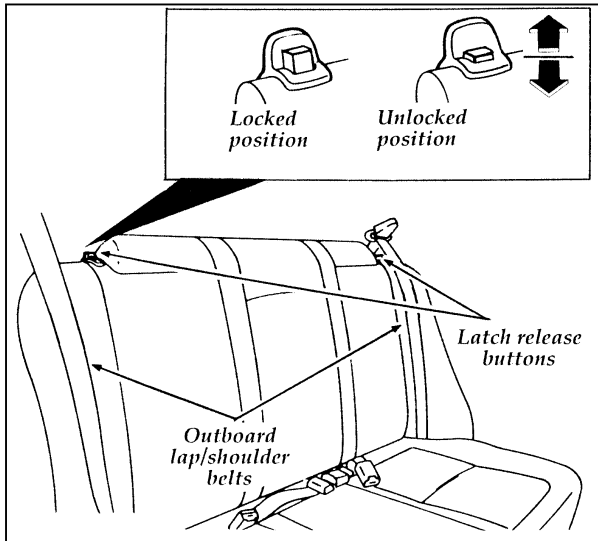

Figure 2: Latch release buttons

Built-In Child Seat Belt Retractors

The belts on the built-in child seat are equipped with a dual locking mode retractor. The child seat belts can be used with the retractor in either the emergency locking mode or the automatic locking mode. In the emergency locking mode, the retractor allows freedom of movement, locking only on hard braking, hard cornering, or collisions. In the automatic locking mode, the retractor will remain locked and does not allow the child freedom of movement.

The retractor will switch from the emergency locking mode to the automatic locking mode when the shoulder belts are pulled all the way out. The retractor will switch back to emergency locking mode when the belts are unbuckled and the shoulder belts retract completely.

The automatic locking mode must be used to hold small children in position, particularly sleeping children and those who may try to squirm out of the belts.

⚠ WARNING

Never leave a child unattended in your vehicle.

⚠ WARNING

Safety belts and seats can become hot in a vehicle that has been closed up in sunny weather; they could burn a small child. Check seat covers and buckles before you place a child anywhere near them.

⚠ WARNING

Failure to follow all of the instructions on the use of this child restraint system can result in your child striking the vehicle's interior during a sudden stop or crash.

How to use the Built-In Child Seat

Read the following procedures and all of the labels on the built-in child seat before using the seat.

⚠ WARNING

Never use the Built-In Child Seat as a booster cushion with the adult safety belts. A child using the adult belts could slide forward and out from under the safety belts.

1. Slide hand under the flap and pull down the top portion of the child seat. See Figure 3.

NOTE: The child seat cannot be opened unless the seatback is latched in the upright position.

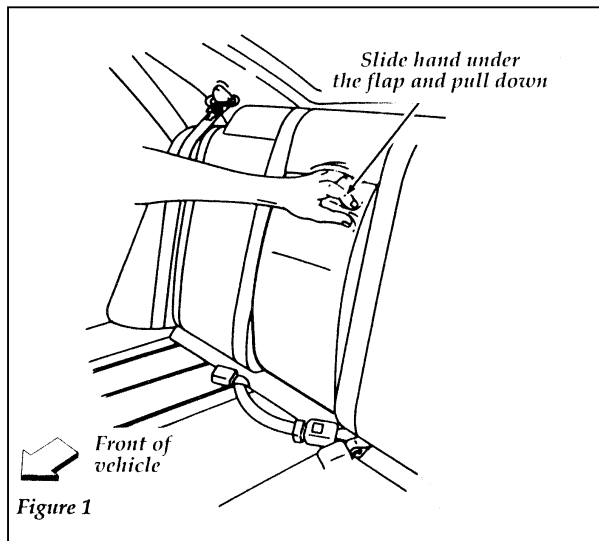

Figure 3: Unfolding built-in child seat

2. Release the cushion retention clip. See Figure 4.

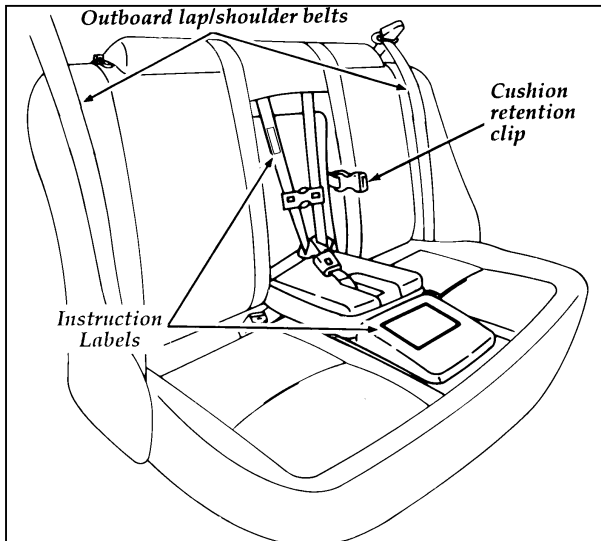

Figure 4: Location of cushion retention clip and warning/instruction labels

3. Lower the child seat cushion. If the child seat cannot be opened, return to the dealer for repair.
4. Read the information and warnings on the top half of the child seat flap and shoulder belt. Refer to Figure 4. Check the child's size, weight and age to be sure the child is not too small or too large for the child seat.

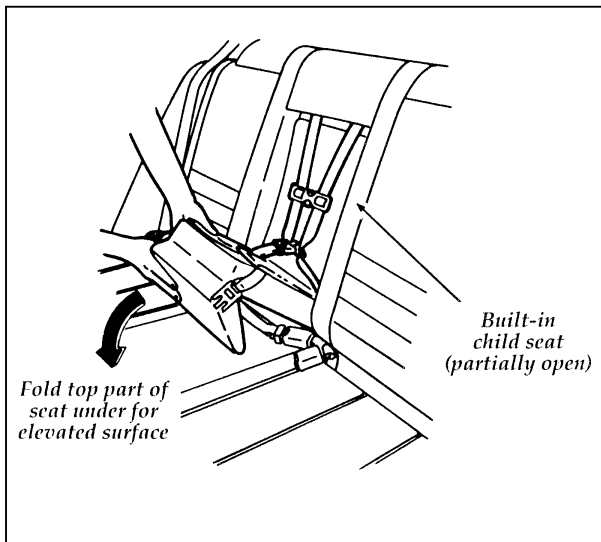

Figure 5: Unfolding built-in child seat

5. Fold the top half of the child seat under the child seat cushion to provide an elevated seating surface as shown in Figure 5.
6. If the chest clip is connected, squeeze the top and the bottom of the right half of the chest clip and pull to separate both halves.

7. Place the child on the child seat and position the shoulder belts over each shoulder. Refer to Figure 6.

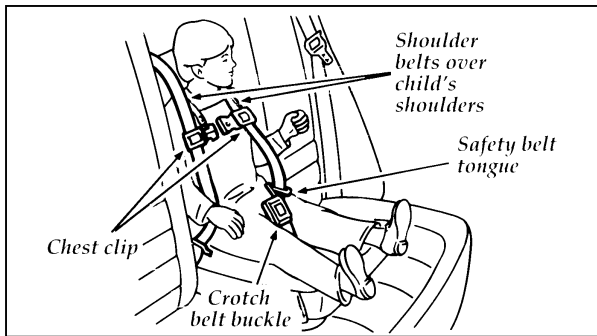

Figure 6: Shoulder safety belt placement on the child

NOTE: Read the following steps carefully to become familiar with the indicator windows located on the crotch safety belt buckle and the chest clip. When either of the tongues or the chest clip is unbuckled, the color red appears in the window. When the tongues or chest clip are securely buckled, the color green appears. See Figures 7 and 9.

8. Insert the left safety belt tongue into the single opening of the crotch safety belt buckle as shown in Figure 6, then insert the right tongue as shown in Figure 7. The indicator window on each tongue must appear green when buckled.

! WARNING

If both tongues do not latch in the buckle, do not use the child seat. See your dealer for repairs.

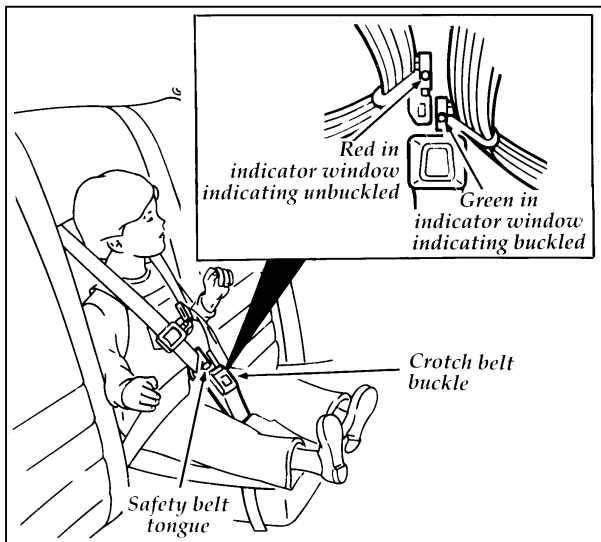

Figure 7: Fastening the crotch safety belt buckle

9. Fasten both halves of the chest clip below the child's shoulders and adjust it to comfortably hold the child's shoulders and adjust it to comfortably hold the shoulder belts in place on the child's chest. The color green must show in the indicator when fastened. The purpose of this clip is to position the shoulder belts correctly on the child's shoulders. The clip can be easily pulled apart and is designed to pull apart during a collision. The clip helps keep the belts on the shoulders of a sleeping or squirming child. Refer to Figures 8 and 9.

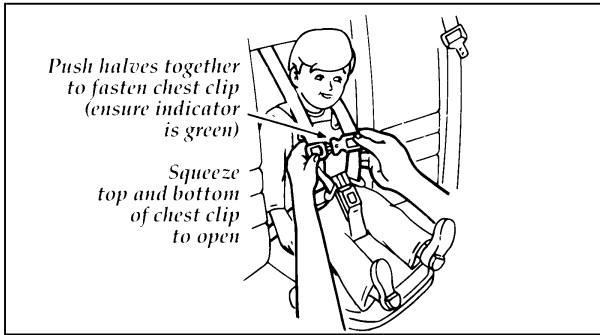

Figure 8: Securing the chest clip

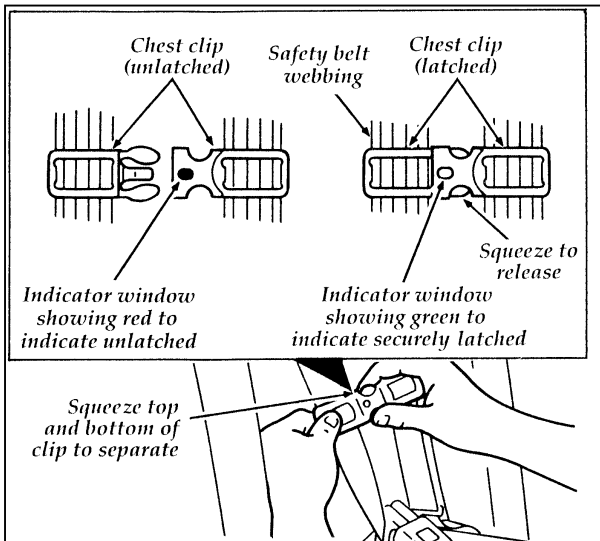

Figure 9: Chest clip indicator window

10. Pull on the safety belt tongues to be sure that they are both latched. See Figure 10.



Figure 10: Checking for securely latched buckle and locked retractor

11. If the child sleeps or tries to get out of the child seat, pull shoulder out fully to put the retractor into automatic lock mode. Allow belts to tighten snugly against the child's shoulders. See Figure 10.

Automatic lock mode keeps a sleeping child in position and prevents the child from getting out of the seat while the vehicle is in motion. Older children who do not fall asleep in the child seat may be secured with the retractor in the emergency locking mode. The belts will lock automatically during a collision or hard braking.

To remove the child from the built-in child seat:

1. Squeeze the tabs on the top and bottom of the chest clip and pull the halves apart to open the chest clip. Refer back to Figure 8.
2. Press the release button on the crotch safety belt buckle.
3. Slide the shoulder belts off the child's shoulders and remove the child. Refer back to Figure 6.

To stow the built-in child seat:

When the built-in child seat is not in use, it can be stowed so that an adult may use the center of the rear seat or the rear seatback can be folded down.

1. Return the child seat cushion to the upright position.
2. Make sure shoulder belts are in the center of the back of the child seat. Attach the cushion retention clip. Fold the child seat up into the seatback while tucking the top edge of the child seat under the flap. See Figure 11.
3. Press firmly in the center of the child seat to keep in the stowed position. You will not be able to unlock the rear seatback if the built-in child seat is not stowed properly.

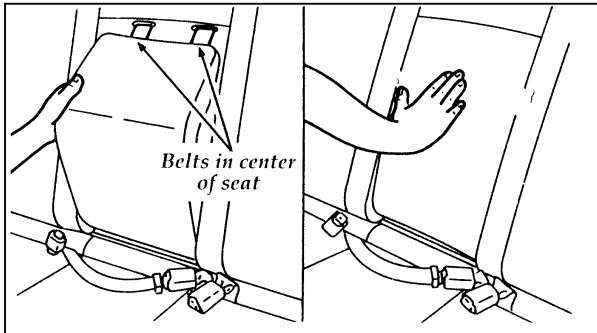

Figure 11: Stowing the built-in child seat

Inspection after a collision:

⚠ WARNING

All built-in child restraints, including seats, buckles, retractors, seat latches, interlocks, and attaching hardware should be inspected by a qualified Dealer technician after any collision. If the child seat was in use during a collision, Ford recommends replacing it. However, if the collision was minor and a qualified technician finds that the child restraints do not show damage and continue to operate properly, they do not need to be replaced. Built-in child seats not in use during a collision should also be inspected and replaced if either damage or improper operation is noted.

Built-in child seat maintenance

Regularly inspect the lap and shoulder belts system of your child seat. See your Ford dealer if the shoulder belt webbing is frayed, or if the buckle and tongue are damaged and/or do not function properly.

Cleaning the built-in child seat

Your built-in child seat may be cleaned with mild soap and water. Do not use household cleaners as they may weaken the webbing or damage the plastic parts. For your convenience, the liner is removable and can be machine-washed and air-dried. See Figure 12.

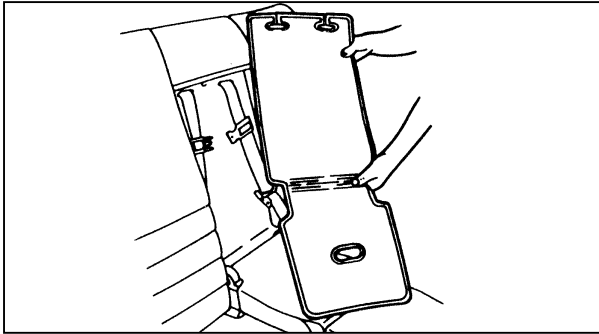

Figure 12: Removing the washable liner

Starting Your Escort

Ignition

Understanding the Positions of the Ignition

Your vehicle may have one of the following lock cylinders depending on when it was built:

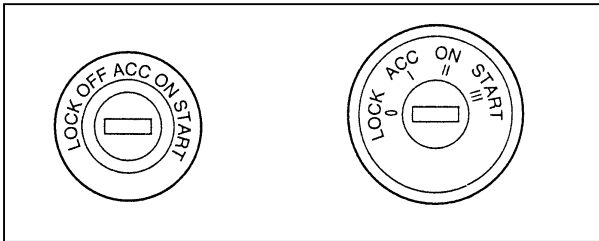

The ignition lock cylinders

LOCK locks the steering wheel when the key is removed. It also locks the console-mounted gearshift on vehicles with automatic transaxles. To turn the key to this position on an automatic transaxle vehicle, the shift control lever must be in P (Park).

WARNING

LOCK position does not lock the gearshift on floor-mounted manual transaxle gearshifts. If the parking brake is not set and the gearshift is moved out of gear, your vehicle may move unexpectedly and injure someone.

The automatic transaxle console-mounted gearshift will lock only when you turn the key to LOCK. When the gearshift is in any gear position but P (Park), the ignition key cannot be turned to LOCK or be removed from the steering column.

If you have a manual transaxle, you must push the key in while turning to the LOCK position in order to remove the key.

LOCK is the only position that allows you to remove the key. The LOCK feature helps to protect your vehicle from theft.

OFF (if equipped) allows you to shut off the engine and all accessories without locking the steering wheel.

ACC (accessory) allows some of your vehicle's electrical accessories such as the radio and the windshield wipers to operate while the engine is not running.

ON allows you to test your vehicle's warning lights (except the brake system warning light) to make sure they work before you start the engine. (The brake system warning light will remain lit if the parking brake is set or if there is a problem with the brake system.) The key returns to the ON position once the engine is started and remains in this position while the engine runs.

START cranks the engine. Release the key once the engine starts so that you do not damage the starter. The key should return to ON when you release it. The START position also allows you to test the brake system warning light.

Removing the Key From the Ignition

Procedures for removing your key from the ignition vary, depending on whether your vehicle has an automatic or manual transaxle.

If your vehicle has an automatic transaxle:

1. Put the gearshift lever in P (Park).
2. Set the parking brake fully.
3. Turn the ignition key to LOCK.
4. Remove the key.

If your vehicle has a manual transaxle:

1. Put the gearshift lever in 1 (First).
2. Set the parking brake fully.
3. Turn the ignition key counterclockwise to ACC. Push the key in while turning to LOCK.
4. Remove the key.

If the key is stuck in the LOCK position, move the steering wheel left or right until the key turns freely.

 WARNING
--

<p>Always set the parking brake fully and make sure that the gearshift is securely latched in P (Park) (automatic transaxle) or in 1 (First) (manual transaxle).</p>

⚠ WARNING

Do not leave children, unreliable adults, or pets alone in your vehicle. They could accidentally injure themselves or others through inadvertent operation of the vehicle. Further, on hot, sunny days, temperatures in a closed vehicle could quickly become high enough to cause severe and possibly fatal injuries to people as well as animals.

Fuel-Injected Engines

When starting a fuel-injected engine, **the most important thing to remember is to avoid pressing down on the accelerator before or during starting.** Only use the accelerator when you have problems getting your vehicle started. See *Starting Your Engine* in this chapter for details about when to use the accelerator while you start your vehicle.

Starting Your Vehicle

Preparing to Start Your Vehicle

⚠ WARNING

Do not start your vehicle in a closed garage or other enclosed area. Never sit in a stopped vehicle for more than a short period of time with the engine running. Exhaust fumes are toxic. See *Guarding Against Exhaust Fumes* in this chapter for more instructions.

Before you start your vehicle, do the following:

1. Make sure all occupants in the vehicle buckle their safety belts. See *Safety Restraints* in the Index for more details.
2. Make sure the headlamps and other accessories are turned off when starting.
3. **If you have an automatic transaxle**, make sure that the gearshift is in P (Park) and the parking brake is set before you turn the key.

If you have an automatic transaxle, your vehicle has a special shift-lock safety feature. It prevents you from moving the gearshift lever out of the P (Park) position unless the ignition is in the ON position and your foot is on the brake. To move the gearshift lever, you must also depress the thumb button.

If you have a manual transaxle, make sure that the parking brake is fully set, push the clutch pedal to the floor, and put the gearshift into Neutral before you turn the key. **(Remember, the starter will operate only if the clutch pedal is pushed all the way to the floor.)**

4. Before you start your vehicle, you should check the warning lights on the instrument panel to make sure that they work. Refer to the *Warning Lights and Gauges* chapter.

Starting Your Engine

To start your engine:

1. Follow the steps under *Preparing to Start Your Vehicle* at the beginning of this section.
2. Turn the ignition key to the ON position.
3. DO NOT depress the accelerator pedal when starting your engine. DO NOT use the accelerator while the vehicle is parked.

4. Turn the key to the START position (cranking) until the engine starts. Allow the key to return to the ON position after the engine has started.

If you have difficulty in turning the key, rotate the steering wheel slightly because it may be binding.

For a cold engine:

- At temperatures **10°F (-12°C) and below:** If the engine does not start in **fifteen (15) seconds** on the first try, turn the key to OFF, wait approximately ten (10) seconds so you do not flood the engine, then try again.
- At temperatures **above 10°F (-12°C):** If the engine does not start in **five (5) seconds** on the first try, turn the key to OFF, wait approximately ten (10) seconds so you do not flood the engine, then try again.

For a warm engine:

- Do not hold the key in the START position for more than **five (5) seconds** at a time. If the engine does not start within five (5) seconds on the first try, turn the key to the OFF position. Wait a few seconds after the starter stops, then try again.

Whenever you start your vehicle, release the key as soon as the engine starts. Excessive cranking could damage the starter.

After starting, allow the engine to idle for a few seconds before driving away.

NOTE: If your vehicle is equipped with an automatic transaxle, your vehicle has an interlock that prevents you from shifting out of P (Park) unless your foot is on the brake pedal.

If the engine does not start after two attempts:

1. Turn the key to the OFF position and wait about two minutes.
2. Press the accelerator all the way to the floor and hold it.
3. Turn the ignition key to the START position.
4. Release the ignition key when the engine starts.
5. Release the accelerator gradually as the engine speeds up. Then drive away in the normal manner.

If the engine still does not start, the fuel pump shut-off switch may have been triggered. For directions on how to reset the switch see *Fuel Pump Shut-Off Switch* later in this chapter.

A computer system controls the engine's idle RPM. When you start your vehicle, the engine's idling RPM normally runs higher than when warm. The engine idle control system should only be serviced by a qualified technician.

If the engine idle speed does not slow down automatically, do not allow your vehicle to idle for more than 10 minutes. Have the vehicle checked.

⚠️ WARNING

Extended idling at high engine speeds can produce very high temperatures in the engine and exhaust system, creating the risk of fire or other damage.

⚠️ WARNING

Do not park, idle, or drive your vehicle in dry grass or other dry ground cover. The emission system heats up the engine compartment and exhaust system, which can start a fire.

Using the Engine Block Heater (If equipped)

Engine block heaters are strongly recommended if you live in a region where temperatures reach -20°F (-29°C) or below consistently during the winter months. An engine block heater warms the engine coolant, which improves starting, warms up the engine faster, and allows the heater-defrost system to respond quickly.

To turn the heater on, simply plug it into a grounded 110-volt outlet. Ford recommends that you use a 110-volt circuit that is protected by a ground fault circuit interrupter.

⚠️ WARNING

To prevent electrical shock, do not use your heater with ungrounded electrical systems or two-pronged (cheater) adapters.

For best results, plug the heater in at least three hours before you start your vehicle. Using the heater for longer than three hours will not damage the engine, so you can plug it in at night to start your vehicle the following morning.

If the Engine Cranks but Does Not Start or Does Not Start After a Collision

The Fuel Pump Shut-off Switch

If the engine cranks but does not start or does not start after a collision, the fuel pump shut-off switch may have been triggered. The shut-off switch is a device intended to stop the fuel pump when your vehicle has been involved in a substantial jolt.

Once the shut-off switch is triggered, you must reset the switch by hand before you can start your vehicle. The fuel pump shut-off switch is located behind the right rear trim panel in the trunk. You can reach the switch to reset it through the access hole.

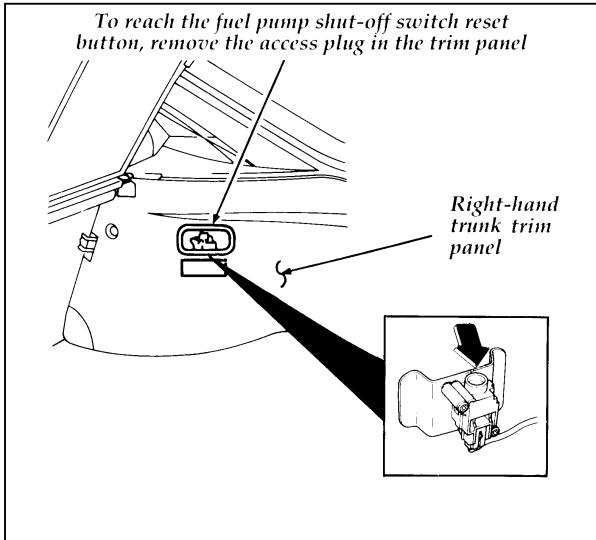

Location of the fuel pump shut-off switch (location on wagon similar)

⚠ WARNING

If you see or smell fuel, do not reset the switch or try to start your vehicle. Have all the passengers get out of the vehicle and call the local fire department or a towing service.

If your engine cranks but does not start after a collision or substantial jolt:

1. Turn the key in the ignition to LOCK.
2. Check under the vehicle for leaking fuel.
3. If you do not see or smell fuel, push the red reset button down. If the button is already set, you may have a different mechanical problem.

4. Turn the ignition key ON for a few seconds, then turn it to LOCK.
5. Check under the vehicle again for leaking fuel. **If you see or smell fuel, do not start your vehicle again.** If you do not see or smell fuel, you can try to start your vehicle again.

Guarding Against Exhaust Fumes

Carbon monoxide, although colorless and odorless, is present in exhaust fumes. Take precautions to avoid its dangerous effects.

 WARNING

Do not start your vehicle in a closed garage or other enclosed area. Never sit in a stopped vehicle for more than a short period of time with the engine running. Exhaust fumes are toxic. See *Guarding Against Exhaust Fumes* in this chapter for more instructions.

 WARNING

If you smell exhaust fumes inside your vehicle, have your dealer inspect your vehicle immediately. Do not drive if you smell exhaust fumes.

Have the exhaust and body ventilation systems checked whenever:

- your vehicle is raised for service
- the sound of the exhaust system changes
- your vehicle has been damaged in a collision

Improve your ventilation by keeping all air inlet vents clear of snow, leaves, and other debris.

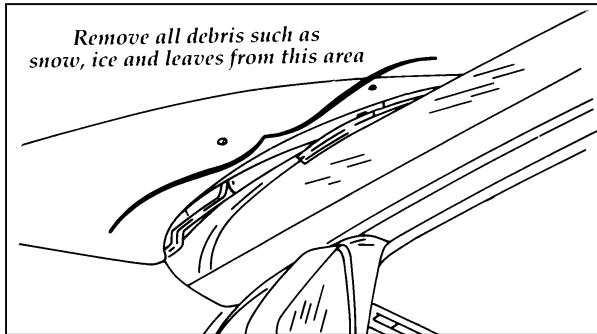

If the engine is idling while you are stopped in an open area for long periods of time, open the windows at least one inch (2.5 cm). Also, adjust the heating or air conditioning system to bring in outside air.

Warning Lights and Gauges

Your vehicle has one of the following clusters:

Standard Cluster

Sport Cluster

If you are not sure which cluster your vehicle has, check the diagrams on the following pages.

Standard Cluster

The following warning lights and gauges are on the standard cluster. All of the warning lights and gauges alert you to possible problems with your vehicle. The following sections detail what each of these indicators means.

The standard cluster

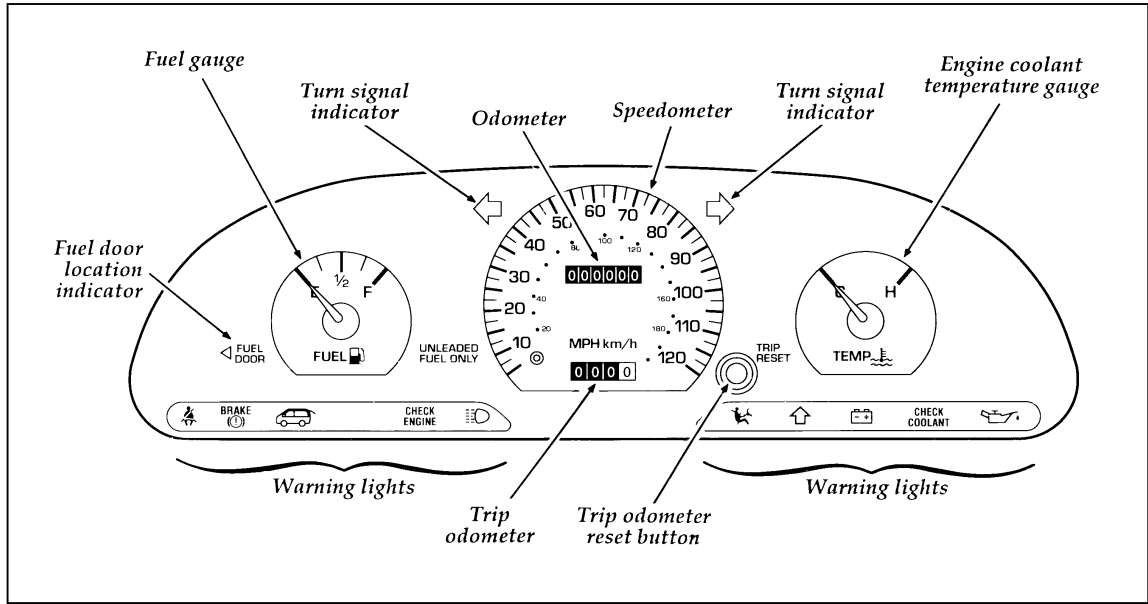

Indicator Lights and Chimes

Safety Belt Warning Light/Chime (U.S. vehicles equipped with motorized passive restraint)

The safety belt warning light/chime reminds you to fasten your safety belt. One of the following will take place:

- If the lap belt is not buckled when the key is turned to the ON position, the light will come on for one to two minutes and the chime will sound for four to eight seconds.
- If the lap belt is buckled while the light is on and the chime is sounding, both the light and chime will turn off.
- If the lap belt is buckled before the key is turned to the ON position, neither the light nor chime will activate.

If the warning light remains illuminated for more than one minute, check to be sure that both shoulder belts are latched to the emergency release buckle. If the warning light remains illuminated with both front seat shoulder belts latched to the emergency release buckles, refer to the section titled *What to Do If Your Shoulder Belt Does Not Engage Properly* before driving the vehicle.

Safety Belt Warning Light/Chime (Canadian vehicles equipped with combination lap and shoulder belts)

This warning light and chime remind you in two ways to fasten your safety belt. If you do not fasten the safety belt before you turn the ignition key to ON, the chime sounds for four (4) to eight (8) seconds. Also, each time you turn the ignition key to ON, the warning light comes on for one to two minutes to remind you to fasten your combination lap and shoulder belt.



The safety belt light

Brake Warning Light

The warning light for the brakes can show two things — that the parking brake is not fully released, or that the brake fluid level is low in the master cylinder reservoir. If the fluid level is low, the brake system should be checked by your dealer or a qualified service technician.

This light comes on when you turn the ignition key to START, but it normally goes off shortly after the engine starts and you release the parking brake. If the light stays on or comes on after you have released the parking brake fully, have the hydraulic brake system serviced.

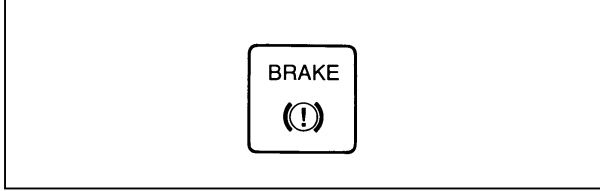

The brake system and parking brake light

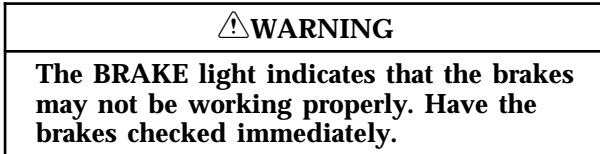

Charging System Light

This light indicates that your battery is not being charged and that you need to have the electrical system checked.

This light comes on every time you turn the ignition to the ON or START position (engine off). The light should go off when the engine starts and the alternator begins to charge.

If the light stays on or comes on when the engine is running, have the electrical system checked as soon as possible.

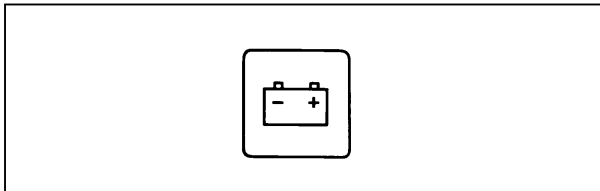

The charging system light

Upshift Indicator Light (If equipped)

This light comes on to indicate when you should shift your manual transaxle to the next higher gear. This light will help you get better fuel economy by lighting when you should shift. (If you have a 1.8L engine you will not have an upshift indicator light.)

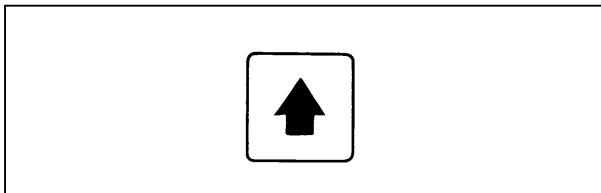

The upshift indicator light

High Beam Light

This light comes on when the headlamps are turned to high beam or when you flash the lights.

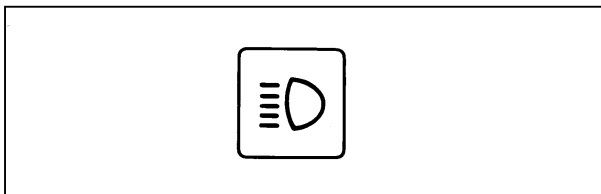

The high beam light

Liftgate Ajar Light (Wagons only)

This light comes on when you turn the ignition key to ON if the liftgate is not fully closed.

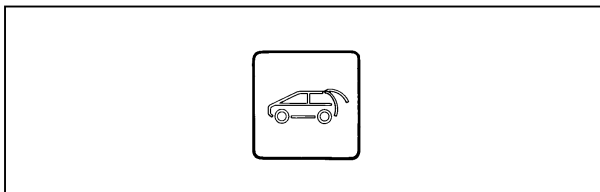

The liftgate ajar light

Chime for Headlamps On

This chime sounds if the driver or any passenger door is open when the parking lamps or headlamps are on. The chime sounds until you close the door, turn off the lamps or turn the ignition to the ON position.

Air Bag Readiness Light

A problem with the system is indicated by one or more of the following: the readiness light will either flash or stay lit, or it will not light, or a group of five beeps will be heard.

WARNING

If any of these things happen, even intermittently, have the air bag system serviced at your Ford or Lincoln-Mercury dealer immediately.

This light illuminates for approximately six seconds when the ignition is turned to the ON position. If the light fails to illuminate, continues to flash, or remains on, have the system serviced as soon as possible.



Air bag readiness light

Check Engine Warning Light

The Powertrain On-Board Diagnostic II (OBD II) system consists of the hardware and software necessary to monitor the operation of the powertrain. The OBD II system is designed to check the function of the vehicle's powertrain control system during normal operation. If an emission problem is detected, the Check Engine Warning Light is turned on.

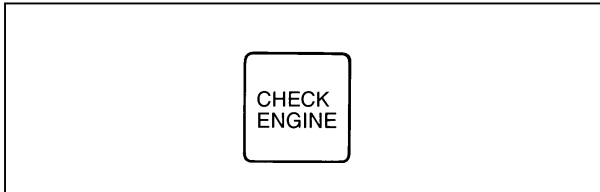

The check engine light

Modification or additions to the vehicle may cause incorrect operation of the OBD II system. Additions such as burglar alarms, cellular phones, and CB radios must be carefully installed. Do not install these devices by tapping into or running wires close to powertrain control system wires or components.

The light comes on briefly when you turn the ignition key to ON, but it should turn off when the engine starts. If the light does not come on when you are driving, have your vehicle

serviced as soon as possible. This indicates a possible problem with one of the vehicle's emission control systems. You do not need to have your vehicle towed in.

If the light turns on and off at one (1) second intervals while you are driving the vehicle, it means that the engine is misfiring. If this condition persists, damage could occur to the engine or catalytic converter. Have your vehicle serviced at the first opportunity. You do not need to have your vehicle towed in.

If the light turns on and off on rare occasions while you are driving, it means that a malfunction occurred and the condition corrected itself.

An example of a condition which corrects itself occurs when an engine running out of fuel begins to misfire. In this case, the Check Engine Warning Light may turn on and will then set a Diagnostic Trouble Code indicating that the engine was misfiring while the last of the fuel was being consumed. After refueling, the Check Engine Warning light will turn off after the vehicle has completed three consecutive warm up cycles without a misfire condition occurring. A warm up cycle consists of engine start from a cold condition (engine at ambient temperature) and running until the engine reaches normal operating temperature.

On the fourth engine start up, the Check Engine Warning Light will turn off as soon as the engine begins to crank. It is not necessary to have the engine serviced.

Under certain conditions, the Check Engine Warning Light may come on if the fuel cap is not properly installed. If the Check Engine Warning Light comes on and you suspect that the fuel cap is not properly installed, pull off the road as soon as it is safely possible and turn off the engine. Remove and replace the fuel cap, making sure it is properly seated.

After completing three (3) consecutive warm up cycles and on the fourth engine start up, the Check Engine Warning light should turn off. If the light does not go off after the fourth engine restart, have your vehicle serviced by your dealer or a qualified technician.

Check Coolant Light

This light indicates that the level of the engine coolant is low and that you should add more coolant. This light comes on when you turn the ignition key to START and remains on for a few seconds after the engine starts, then normally goes out. See *Engine coolant* in the Index.

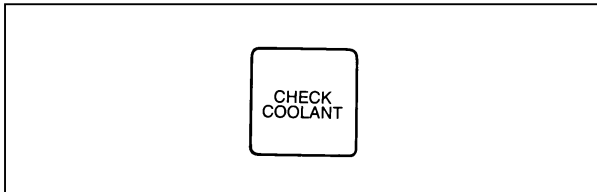

The check coolant light

If the CHECK COOLANT warning light stays on, turn the ignition key to OFF and fill the recovery bottle to the FULL HOT mark. If the CHECK COOLANT warning light comes on and stays on after the recovery bottle has been filled, have your vehicle serviced as soon as possible.

Turn Signal Indicator Lights

When you push the turn signal lever up before making a right turn, the right side arrow on the instrument panel flashes.

When you push the turn signal lever down before making a left turn, the left side arrow on the instrument panel flashes.

Usually, the turn signals turn off automatically after you turn your vehicle. If the turn signal continues to flash after you have made the turn, pull the lever back to OFF.

Anti-lock Brake System Warning Light (If equipped)

Your vehicle may have an Anti-lock Brake System (ABS) feature. If it does, check the Anti-lock Brake System (ABS) light each time you start the engine. If it stays on longer than six seconds, shut off the engine and restart. If it stays on, that means the Anti-lock Brake feature isn't working and should be serviced immediately to restore the benefits of the anti-lock brake feature. Normal braking is not affected unless the brake warning light is also lit.

The Anti-lock Brake System has self-check capabilities. As described above, the system turns on the anti-lock light each time you start your engine. After the engine is started and the anti-lock light turns off, the system performs another test the first time the vehicle reaches 7 mph (11 km/h). The system turns on the ABS pump motor for approximately 1/2 second. At this time, a mechanical noise may be heard. This is a normal part of the self-check feature. If a malfunction is found during this check the anti-lock light will come on.

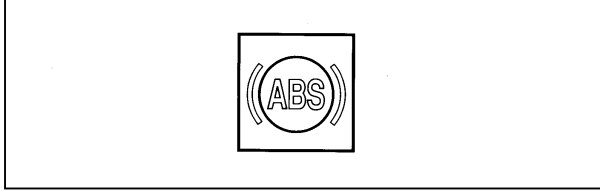

The anti-lock brake system light

Engine Oil Pressure Warning Light

This light indicates low oil pressure, **not low oil level**. However, if your engine's oil level is low, it could affect the oil pressure. This light comes on every time your ignition key is turned to ON or START. The light should turn off after a few seconds. If the light stays on when the engine is running, you have lost oil pressure and continued operation will cause severe engine damage.

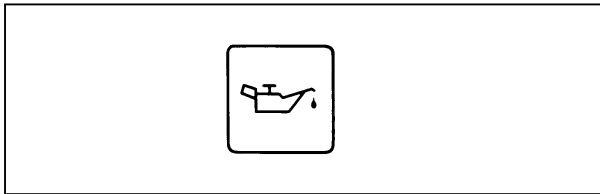

The engine oil pressure light

1. Pull off the road as soon as safely possible.
2. Shut off the engine immediately. If you do not stop the engine as soon as safely possible, severe engine damage could result.
3. Check the engine's oil level, following the instructions on checking and adding engine oil in this Owner Guide. (See *Engine oil* in the Index.) If you do not follow these instructions, you or others could be injured. To ensure an accurate reading, your vehicle should be on level ground.

4. If the oil level is low, add as much oil as necessary before you drive your vehicle again. Do not overfill. Do not operate the engine when the oil pressure light is on, even if the oil level is correct. For more information about adding oil, see *Adding engine oil* in the Index.

Fuel Gauge

The fuel gauge displays approximately how much fuel is in the fuel tank only when the ignition switch is ON.

For proper fuel gauge indication after adding fuel, the ignition switch should be in the OFF position while the vehicle is being refueled.

The fuel gauge indicator may vary slightly when the vehicle is in motion.

With the ignition switch OFF, the fuel gauge indicator may drift from the ignition switch ON position.

Speedometer

The speedometer tells you how many miles (kilometers) per hour your vehicle is moving.

Odometer

The odometer tells you the total number of miles (kilometers) your vehicle has been driven.

Trip Odometer

The trip odometer tells you how many miles (kilometers) your vehicle has been driven since the last reset. Press the reset button to return the trip odometer to zero.

Engine Coolant Temperature Gauge

This gauge indicates the temperature of the engine coolant, not the coolant level. If the coolant is not at its proper level or mixture, the gauge indication will not be accurate.

The pointer moves from C (Cold) into the normal band as your vehicle warms up. Under most driving conditions, the pointer should stay in the normal band. If you are driving in heavy traffic or uphill in hot weather, the pointer may reach to the top of the normal band.

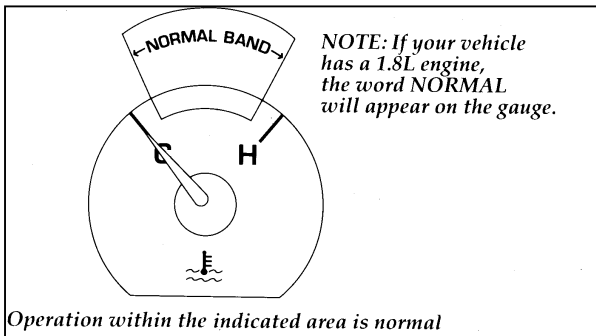

Under any circumstances, if the pointer moves past the upper limit of the normal band, the engine is overheating and may result in engine damage.

If your engine coolant overheats:

1. Pull off the road as soon as it is safely possible.
2. Turn off the engine.
3. Let the engine cool.
4. Check the coolant level following the instructions on checking and adding coolant to your engine. (See *Engine coolant* in the Index.) If you do not follow these instructions, you or others could be injured.
5. Add as much coolant as your engine needs. If the engine continues to overheat, have the coolant system serviced.

The Sport Cluster

The sport cluster has basically the same standard warning lights and gauges as the standard cluster, with the following additional features:

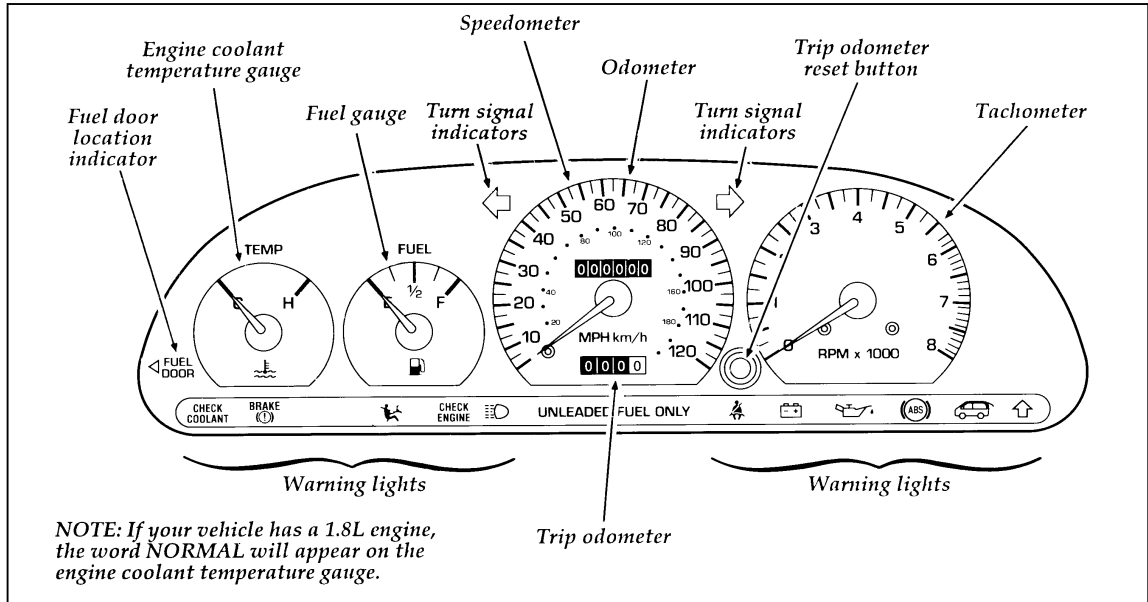

Tachometer

The tachometer tells you the approximate engine revolutions per minute (how fast the engine is running). The tachometer is on the right side of the instrument cluster.

Driving with the pointer in the red zone may cause engine damage.

Instrument Panel Controls

The instrument panel (dashboard) on your vehicle is divided into several different sections. The illustrations on the following pages show the major parts of the instrument panel that are described in this chapter. Some items shown may not be on all vehicles.

The main controls for the climate control system, lamps, clock, and radio are on the instrument panel.

Instrument panel — typical equipment shown

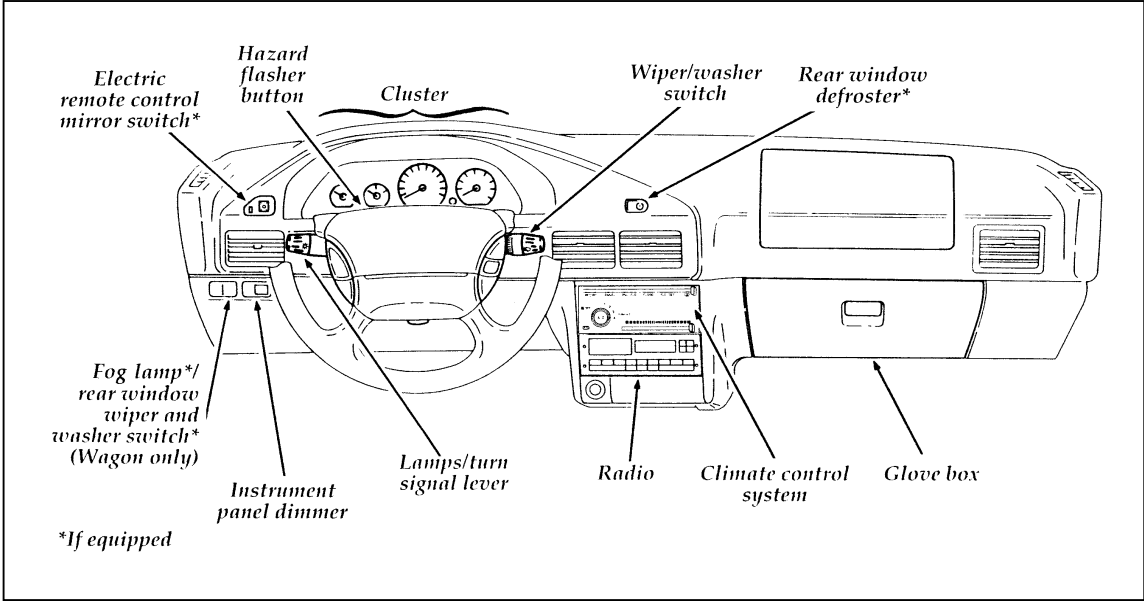

If you have radio transmitting equipment in your vehicle, be aware that it can interfere with your vehicle's electrical system and may cause the instrumentation and/or convenience products to have temporary, abnormal operation.

NOTE: Any cleaner or polish that increases the gloss (shine) of the upper part of the instrument panel should be avoided. The dull finish in this area is to help protect the driver from undesirable windshield reflection.

The Climate Control Systems

Your vehicle has one of the following climate control systems:

- Heating Only System
- Heating and Air Conditioning System

If you are not sure which system your vehicle has, see the diagrams on the following pages.

The Controls

The fan speed knob controls the volume of air circulated in the vehicle. There are four fan settings numbered 1 (low) through 4 (high) and on OFF position.

Pushing the A/C button (in the center of the fan speed knob) turns on the air conditioning system, if equipped. The fan must be on for the air conditioning compressor to operate. The indicator light, to the left of the fan speed knob, will glow when the A/C system is on.

The temperature control lever may be adjusted from cool air in the blue range to warm air in the red range.

The A/C system provides maximum cooling, dehumidifying and better fueling efficiency when the function selector lever is set to the MAX A/C position.

The function selector lever controls how the air is circulated.

- RECIRC position (heating system only) or MAX A/C (heating and air conditioning system only) circulates the air from inside the vehicle through the instrument panel vents. This position prevents outside air from entering the vehicle.
- PANEL position directs air through the instrument panel registers.
- PNL/FLR position directs air through both the instrument panel registers.
- FLOOR position directs air mainly through the floor ducts.
- FLR/DEF position directs air through both the floor ducts and the windshield defroster outlets.
-  (Defrost) position directs air to the windshield through the defroster outlets.

Comfort Tips

- For maximum cooling, push the A/C button to turn on the system (if equipped) and turn the fan knob to 4 (indicator light will glow). Set the function selector lever to the recirculated position (MAX A/C), and the temperature control lever all the way to the left in the blue (cool) range.
- If the inside of your vehicle is very warm, drive for a few minutes with the windows down. This forces most of the hot, stale air out of the vehicle and helps the air conditioning (if equipped) to cool the vehicle faster.
- For the best ventilation, move the function selector lever to PANEL and select the desired temperature and fan speed.

For maximum heating, set the function selector lever to FLOOR, PANEL, PNL/FLR or FLR/DEF, the temperature control lever all the way to the right in the red (warm) range and the fan speed knob to 4.

Defrosting/Defogging Tips

For maximum defrosting
in cold weather

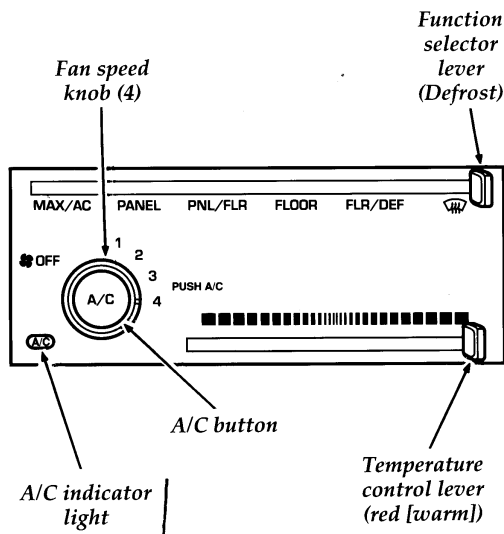

NOTE: Heating and air conditioning system shown. If equipped with a heating only system, use the same fan speed knob, function selector lever, and temperature control lever settings as shown above.

Setting the climate controls for cold weather defrosting

For maximum defogging at warm temperatures (45°F [7°C] or above)

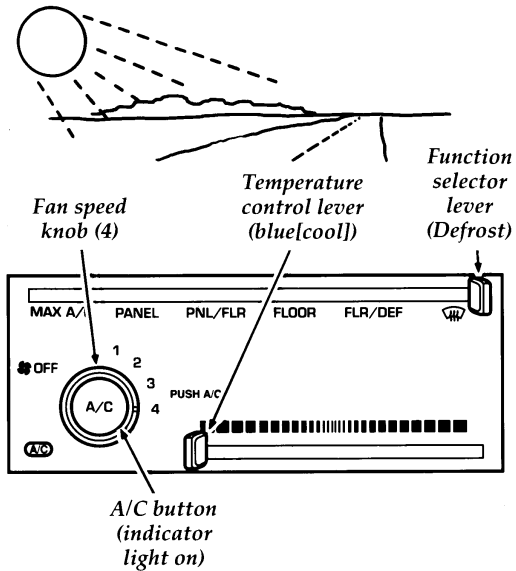

NOTE: Heating and air conditioning system shown. If equipped with a heating only system, use the same fan speed knob, function selector lever, and temperature control lever settings as shown above.

Setting the climate controls for warm weather defogging

- Under normal conditions, when the vehicle is parked, the climate control system should be left with the function selector lever in any position other than RECIRC (heating) or MAX A/C (heating and air conditioning system). This allows the vehicle to “breathe” through the air vents.

Heating Only System (Without air conditioning)

You can heat the inside of your vehicle, defrost the windshield, or use the outside air vents by using the climate controls on the center of the instrument panel.

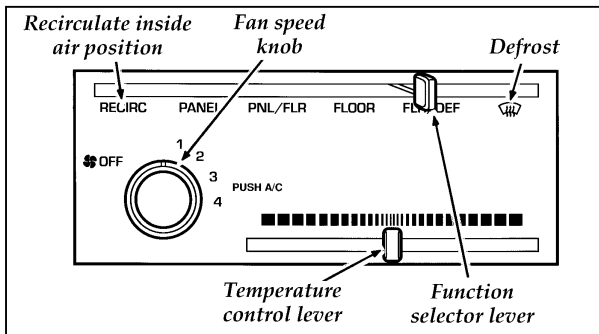

The levers that control the standard heating system

Turning on the heat

To heat the inside of your vehicle

1. Move the function selector lever to PANEL, PNL/FLR, FLOOR, FLR/DEF or  (Defrost).

When PANEL is selected, air is directed out of the panel registers.

When PNL/FLR is selected, air is directed out of the panel registers and the floor ducts.

When FLOOR is selected, most of the air is directed through the floor ducts, and a little air is also directed at the windshield and side windows to help prevent fogging.

When FLR/DEF is selected, air is directed through the floor ducts and the defroster outlets.

When  (Defrost) is selected, air is directed out of the defroster outlets.

2. Move the temperature control lever to the red (warm) area or to the desired temperature.
3. Set the fan at the desired speed.

To defrost the windshield and the side windows:

1. Move the function selector lever to the defrost symbol.

When the defrost symbol is selected, most of the air is directed to the windshield and a small amount is directed toward the side windows. The defrost mode also helps defog interior window surfaces.

2. Move the temperature control lever to the red (warm) area or to the desired temperature.
3. Set the fan speed at 4.

Heating and defrosting at the same time

To heat the inside of your vehicle and defrost the windshield at the same time:

1. Position the function selector lever at FLR/DEF.

When the function selector lever is in this position, air is split between the floor, windshield, and the side window demisters.

2. Move the temperature lever to the red (warm) area or to the desired temperature.
3. Set the fan speed at 4.

Ventilating your vehicle with outside air

On mild days, you may want to ventilate your vehicle with outside air. To open the vents:

1. Move the function selector lever to PANEL.
2. Move the temperature control lever to the blue (cool) area or to the desired temperature.
3. Set the fan at the desired speed.

Bi-level operation:

1. Move the function selector lever to the PNL/FLR position.
2. Move the temperature control lever to the desired temperature.

NOTE: The temperature of the air coming from the panel vents will be cooler than the temperature of the air coming from the floor vents. The difference in temperatures can be controlled by adjusting the temperature control lever. The maximum difference in temperatures will occur when the temperature control lever is in the center range (between the red [warm] and blue [cool] positions). This feature is especially useful on cool yet sunny days, when the vehicle is warmed by the sun yet you desire warmer air at your feet.

3. Set the fan at the desired speed.

Tips for Controlling the Temperature in Your Vehicle

- To adjust the temperature inside your vehicle, use the temperature control lever. Move the control between red (warm) and blue (cool) for comfort.
- Do not drive with the air inlet selector lever in the “recirculate” position (MAX A/C on heating and air conditioning systems or RECIRC on heating only systems). Driving with the climate control system in this mode may cause severe window fogging.
- Remove any snow, ice, or leaves from the area below the windshield on the outside of your vehicle. They could block the air intake.

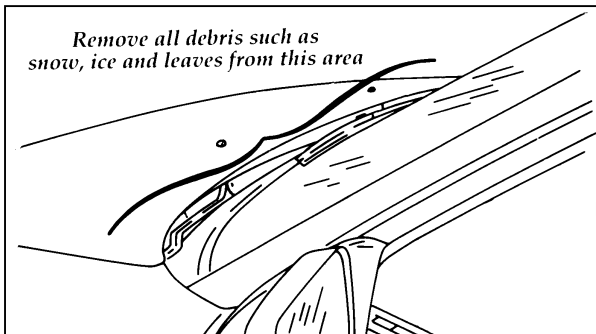

- Under normal conditions, the system should be left in PANEL, PNL/FLR, FLOOR, FLR/DEF, or the defrost position. This allows the vehicle to “breathe” through the air vents.
- To prevent fogging of the windshield in cool and humid weather, set the function selector lever to the defrost position before starting the engine.

Heating and Air Conditioning System (If equipped)

You can heat the inside of your vehicle, defrost the windshield, and turn on the air conditioning by using the climate controls on the center of the instrument panel.

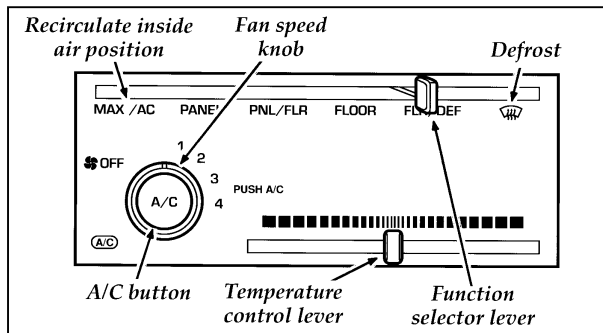

The heating and air conditioning controls

Refer to *Tips for Controlling the Temperature in Your Vehicle* in the previous section for hints on temperature control.

Turning on the heat

To heat the inside of your vehicle:

1. Move the function selector lever to PANEL, PNL/FLR, FLOOR, FLR/DEF, or  (Defrost). See *The controls* earlier in this chapter for a description of these positions.
2. Move the temperature control lever to the red (warm) area or to the desired temperature.
3. Set the fan at the desired speed.

Heating and defrosting at the same time

1. Position the function selector lever to FLR/DEF.
2. Move the temperature lever to the red (warm) area or to the desired temperature.
3. Set the fan speed at 4.

To defrost the windshield and side windows:

1. Move the function selector lever to the  (defrost) symbol.

When the defrost symbol is selected, most of the air is directed to the windshield and a small amount is directed toward the side windows. The defrost mode also helps defog interior window surfaces.

2. Move the temperature control lever to the red (warm) area or to the desired temperature.

NOTE: In temperatures greater than 45°F (7°C), press the A/C button on in order to dehumidify the incoming air and enhance defogging performance.

3. Set the fan speed at 4.

Turning on the air conditioning

To cool your vehicle quickly in warm weather:

1. Press the A/C button.
2. Move the temperature control lever to the blue (cool) area.

3. Move the function selector lever to the MAX A/C position.

When the function selector lever is in the MAX A/C position, cooled interior air is recirculated through the system. This position is more economical than continually cooling outside air.

4. Set the fan at the desired speed.

If the inside of your vehicle is very warm, drive for a few minutes with the windows down. This forces most of the hot, stale air out of the vehicle and helps the air conditioning cool the vehicle faster.

Cooling your vehicle with outside air

Use any function selector lever position except for MAX A/C to cool your vehicle with outside air. Cooling your vehicle in this way brings in outside air and is quieter but less economical than using recirculated air.

To cool your vehicle using outside air:

1. Press the A/C button.
2. Move the function control lever to PANEL or to the desired position.
3. Move the temperature control lever to the blue (cool) area.
4. Set the fan at the desired speed.

To ventilate your vehicle with outside air

In mild weather, use the outside, cooler air to ventilate the vehicle. You will get better fuel economy by not using the air conditioning.

To ventilate your vehicle using the vents:

1. Be sure that the A/C is off.
2. Move the function selector lever to PANEL.
When PANEL is selected, outside air is directed out the instrument panel registers.
3. Move the temperature control lever to the blue (cool) area or to the desired temperature.
4. Set the fan at the desired speed.

Bi-level operation:

1. Move the function selector lever to the PNL/FLR position.
2. Turn on the air conditioning, if desired.
3. Move the temperature control lever to the desired temperature.

NOTE: The temperature of the air coming from the panel vents will be cooler than the temperature of the air coming from the floor vents. The difference in temperatures can be controlled by adjusting the temperature control lever. The maximum difference in temperatures will occur when the temperature control lever is in the center range (between the red [warm] and blue [cool] positions). This feature is especially useful on cool yet sunny days, when the vehicle is warmed by the sun yet you desire warmer air at your feet.

4. Set the fan at the desired speed.

Rear Window Defroster (If equipped)

The defroster for the rear window clears frost, fog, and thin ice from the inside and outside rear window.

The button for the rear window defroster is on the instrument panel to the right of the steering column.

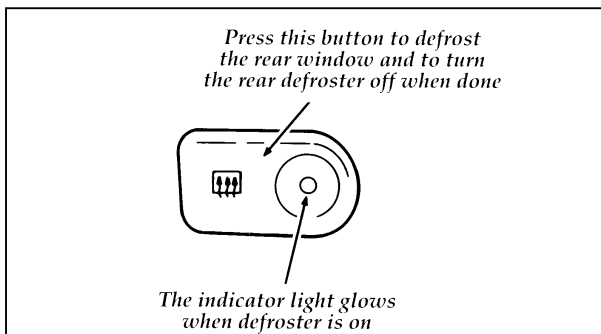

The button that controls the rear window defroster

To defrost the rear window:

1. Clear any snow from the rear window.
2. Get in your vehicle and start the engine.
3. Press the rear window defrost button. The ON indicator will illuminate.
4. When the rear window is clear, push the button again to turn off the defroster.

NOTE: Do not use sharp objects to scrape the inside of the rear window or use abrasive cleaners to clean the inside of the rear window surface. You could damage the heating elements, which are bonded to the inside surface of the rear window.

The Interior and Exterior Lights

Turning On the Exterior Lights

To turn on your headlamps, parking lamps, side markers, license lamps, instrument panel lamps, and tail lamps, twist the knob at the end of the turn signal lever located to the left of the steering wheel.

To turn on the parking lamps, side marker lamps, instrument panel lamps, license lamps, and tail lamps, rotate the knob to the first position.

To turn on the headlamps in addition to the other lamps, rotate the knob to the second position.

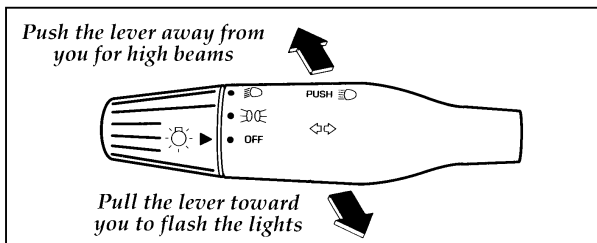

The lever for the headlamps, parking lamps and tail lamps

To change your headlamps from low to high beam, push the turn signal lever away from you until it latches, and release.

For more information about how the high beam headlamps work, see *Steering column controls* in the Index.

Daytime Running Light System

(Canadian vehicles only)

The Daytime Running Light (DRL) system turns the high beam headlamps on, with a reduced light output, when:

- The headlamp system is in the OFF position, and
- The vehicle is running, and
- The vehicle has a fully released parking brake.

The high beam indicator light on the instrument cluster will not be on.

 WARNING
--

<p>The Daytime Running Light (DRL) system will not illuminate the tail lamps and parking lamps. Turn on your headlamps at dusk. Failure to do so may result in a collision.</p>
--

Fog Lamps (If equipped)

The fog lamps switch is located to the left of the steering wheel on the instrument panel. The fog lamps will operate only when the low beam headlamps are on.

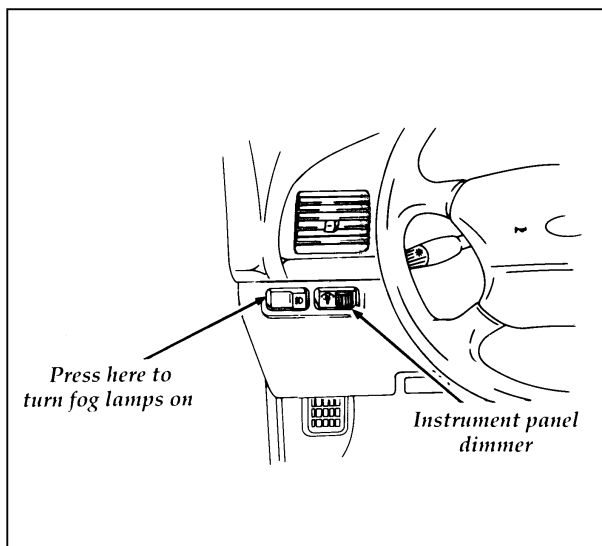

Fog lamp switch

Cleaning the Exterior Lamps

Do not use dry paper towel, chemical solvents or abrasive cleaners to clean the lamps, as these may cause scratches or crack the lamps.

Lighting Up the Interior and Instrument Panel

You can brighten or dim the lights in the instrument panel.

To do this, turn the instrument panel dimmer thumbwheel located on the instrument panel to the left of the turn signal lever.

Interior Lamps

Your vehicle has an interior lamp for your convenience. You can set it to automatically turn on whenever a door is open, or you can set it to stay on or off.

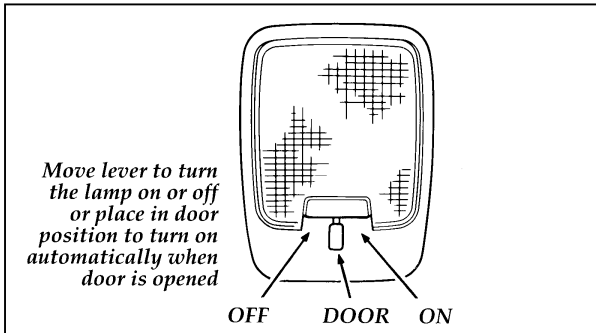

The courtesy lamps on the overhead lamp dome

Dome/Map/Reading Lamps (If equipped)

Your vehicle may have a map lamp for the passenger and one for the driver.

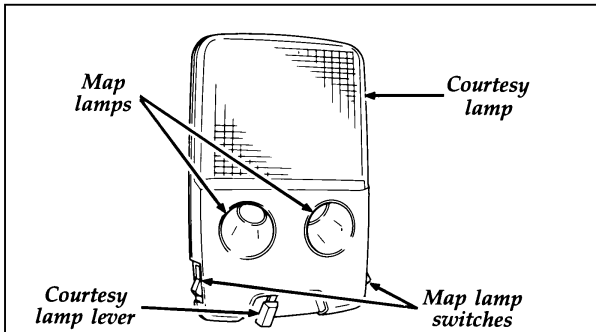

The courtesy and map lamps

To turn on the map lamps, push the switches next to each lamp. If your vehicle is equipped with a moon roof, you will have a different style of map lamps. Refer to *Moon roof* in the Index.

Cleaning the Interior Lamps

Your interior dome lamps and map lamps are plastic and should be cleaned with a mild detergent diluted in water. Rinse them with clear water.

High-Mount Brakelamp

Your vehicle is equipped with a high-mount brakelamp. The high-mount brakelamp illuminates whenever you apply the brakes.

On 4-door hatchback, 2-door hatchback and wagon models, the high-mount brakelamp is mounted on the liftgate at the base of the rear window.

On the 4-door LX model, the high-mount brakelamp is mounted on the base of the rear window.

On the Sport and GT, the high-mount brakelamp is located between the spoiler and the trunk lid.

Rear Window Wiper and Washer (Available on wagons only)

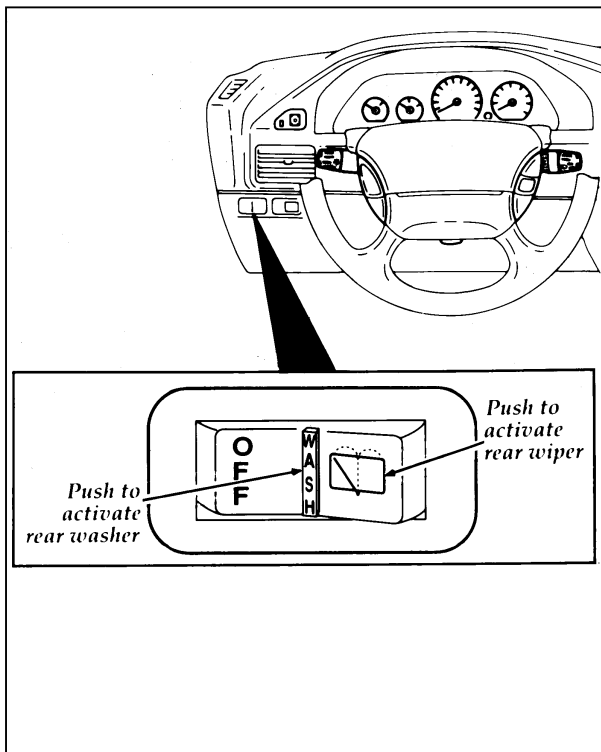

To use the rear window wiper, push the right side of the rear window wiper and washer switch. Push the left side of the switch to turn the rear window wiper off. To wash the rear window, push in the button marked WASH. Windshield washer fluid will stream onto the rear window.

Clock Controls on Electronic Radios

Electronic radios have built-in clocks. For complete operating instructions, refer to the *Electronic Sound Systems* chapter in this Owner Guide.

Radio

For information about the radio in your vehicle, refer to the *Electronic Sound Systems* chapter in this Owner Guide.

Radio Antenna

Your vehicle's radio antenna is mounted on the top of the windshield on the left (driver) side of the vehicle.

If your vehicle's radio antenna is mounted near the top of the windshield on the left (driver) side of the vehicle, the antenna can be extended by pulling it upward away from its mounting base. To retract the antenna push it in toward its mounting base.

NOTE: To receive the best reception, the antenna must be fully extended. Some wind noise is normal with the antenna in the fully extended position. If the antenna is not fully extended, the result may be weak or noisy radio reception.

NOTE: The retractable radio antenna must be pushed in prior to entering a car wash. Failure to retract the antenna could result in damage to the antenna, antenna base, or vehicle.

Cleaning the Instrument Panel Lens

Clean the instrument panel lens with a soft cloth and a glass cleaner, such as Ford Ultra-Clear Spray Glass Cleaner, or equivalent. Do not use paper towel or an abrasive cleaner to clean the lens as these may cause scratches.

Steering Column Controls

The controls on the steering column and wheel are designed to give you easy access to the controls while you are driving.

The Turn Signal Lever

You can use the turn signal lever on the left side of the steering column to:

- operate the turn signals
- turn the high beams on/off
- flash the lamps

Turn Signals

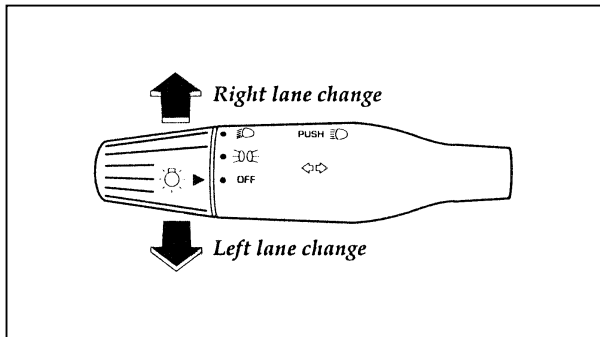

Turn signal operation

If the turn indicator light in the instrument panel does not illuminate or remains on (doesn't flash) when you signal a turn, the turn signaling system is malfunctioning. Have this condition corrected as soon as possible, but make sure that you use the accepted hand signals in the meantime.

High Beams and Flashing the Lamps

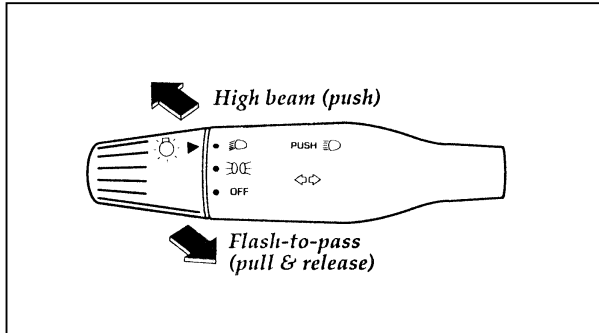

High beams and flashing the lamps

Windshield Wipers and Washer

To turn on the windshield wipers, the ignition key must be turned to the ON or ACC position.

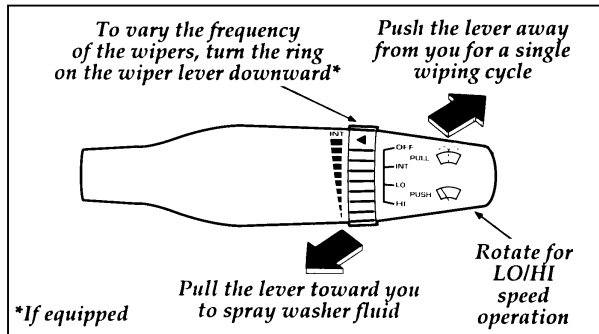

Windshield wipers and washer

To set the interval wipers, rotate the knob at the end of the turn signal lever toward or away from the instrument panel to the interval operation you desire.

To clean the windshield, push in the end of the wiper knob. For a constant spray, keep the knob pushed in. After you release the knob, the wipers operate for two or three cycles before turning off (if wipers were off) or returning to the interval setting selected.

Do not try to clean the windshield when the washer fluid container is empty or activate the washers at any time for more than 15 seconds continuously. This could damage the washer pump system.

 **WARNING**

In freezing weather, warm up the windshield with the defroster before you use the washer fluid. If you do not do this, the washer solution may freeze on the windshield and obscure your vision. This may result in a collision, possibly injuring you and others.

For information about refilling the washer fluid or replacing your windshield wiper blades, see *Windshield washer fluid and wipers* in the Index.

Hazard Flasher

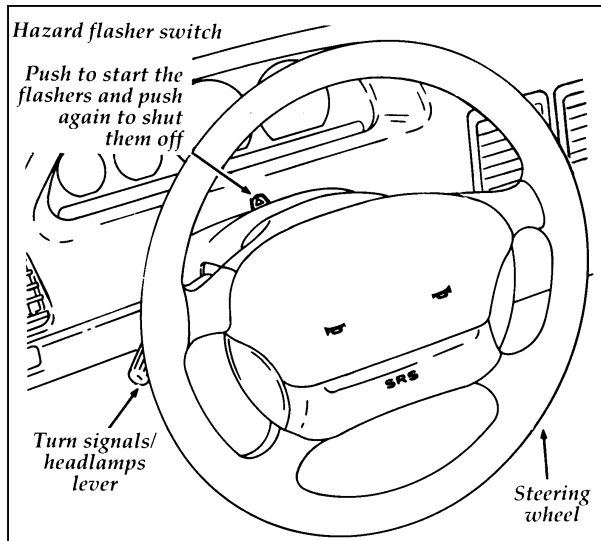

Using the hazard flasher switch

The hazard flasher serves as a warning to other drivers to be careful when approaching or passing your vehicle.

The flashers work whether your vehicle is running or not. The flashers work for up to two hours when the battery is fully charged and in good condition without draining the battery excessively. If the flashers run for longer than two hours or if the battery is not fully charged, the battery power can be drained.

Horn

To sound the horn, push the pad in the center of the steering wheel. Check the horn regularly to be sure it operates properly.

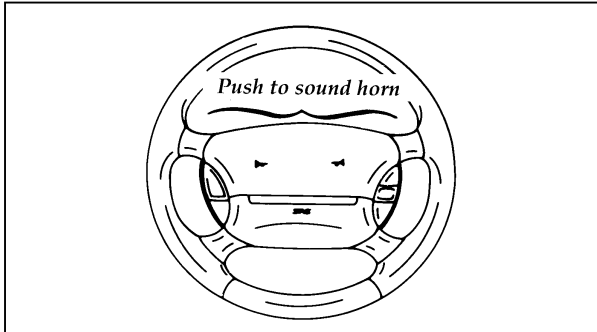

The horn located on the steering wheel

Tilt Steering Column (If equipped)

WARNING

Never adjust the steering wheel when the vehicle is moving. You could lose control of the vehicle and injure someone.

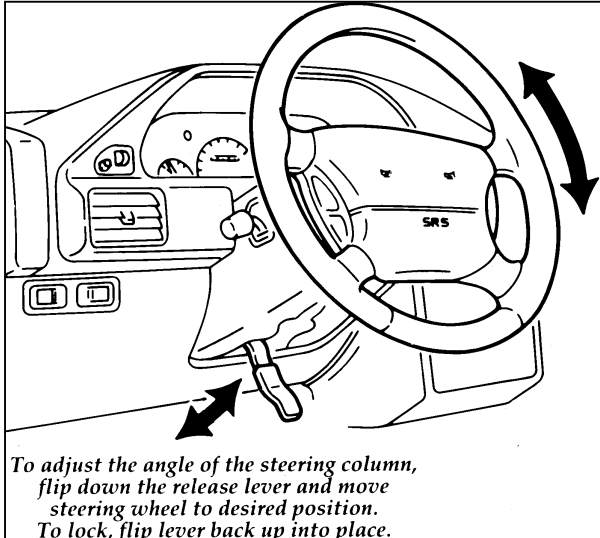

The lever to tilt the steering column

To change the position of the steering wheel, push the release lever under the steering column away from you. Tip the steering wheel to the desired position. Pull the lever back into place to lock the steering wheel.

Speed Control (If equipped)

If your vehicle has speed control, you can automatically maintain a constant speed at or above 30 mph (50 km/h).

Use of radio transmitting equipment that is not Federal Communications Commission (FCC) or in Canada the Canadian Radio and Telecommunications Commission (CRTC) approved may cause the speed control to malfunction. Therefore, use only properly installed FCC (CRTC in Canada) approved radio transmitting equipment in your vehicle.

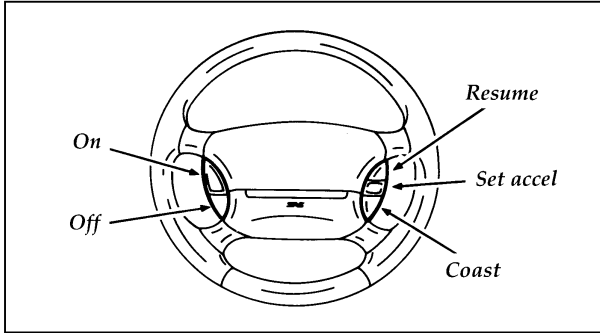

The speed control switches on the steering wheel

To set the speed control

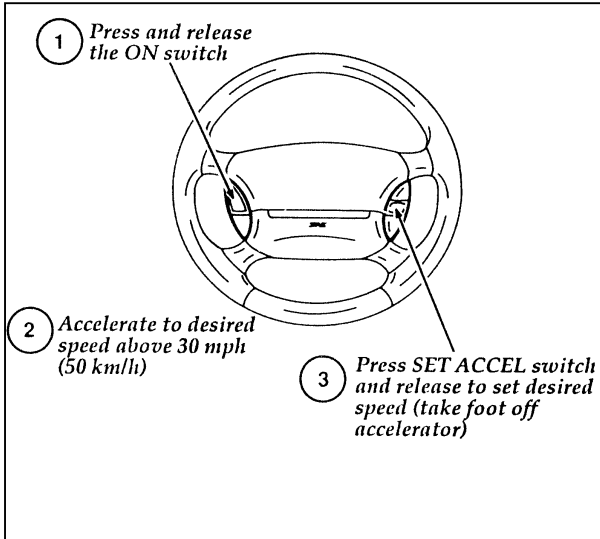

NOTE: If your vehicle is equipped with an automatic transaxle, and if your speed increases above your set speed while driving in **D** (Overdrive) on a downhill grade, you may want to shift to **D** (Drive). This will reduce vehicle speed. Speed control cannot reduce the vehicle speed if it goes above your set speed on a downhill grade.

NOTE: If your vehicle is equipped with a 5-speed manual transaxle, and if your speed increases above your set speed while driving in 5 (fifth) gear on a downhill grade, you may want to shift to 4 (Fourth) gear to reduce vehicle speed. Depressing the clutch pedal cancels speed control, therefore speed control must be reset by pressing the **SET ACCEL** or **RESUME** switches. Speed control cannot reduce the vehicle speed if it goes above your set speed on a downhill grade.

⚠ WARNING

To keep control of your vehicle, do not use the speed control in heavy traffic or on roads that are winding, slippery, or unpaved.

If you want to speed up momentarily or regain preset speed on hills when the speed control is operating, accelerate using the accelerator pedal. Manually accelerating to a higher speed does not interfere with the speed control; when you take your foot off the accelerator, the vehicle returns to the set speed.

NOTE: Do not shift to N (Neutral) when using the speed control. This will cause the engine to overspeed.

When driving uphill, especially with a heavy load, significant speed drops may occur. If the speed drops more than 8 to 14 mph (13-23 km/h) the automatic speed control will cancel. You may need to control your speed manually while driving up steep grades in order to maintain the selected speed.

To turn off the speed control or to reset speed:

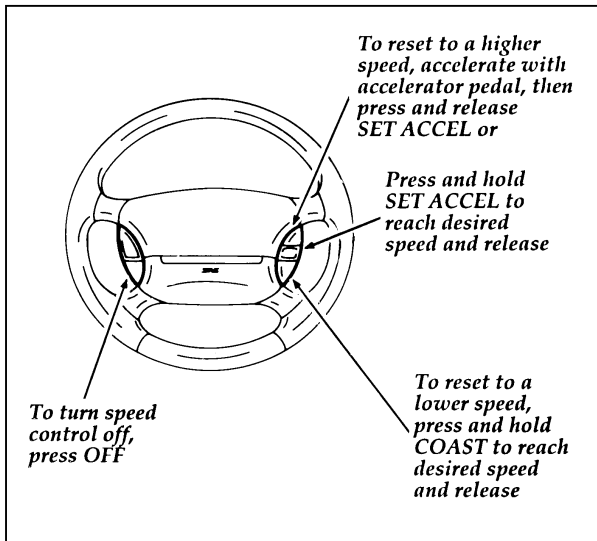

The speed control is turned off each time you turn off the vehicle.

To cancel speed control and then resume a set speed

- 1 Press the brake or clutch pedal to cancel
- 2 Accelerate to at least 30 mph (50 km/h) to resume set speed
- 3 Press RESUME and release

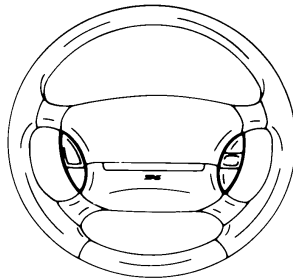

NOTE: Use of radio transmitting equipment that is not Federal Communications Commission (FCC) or in Canada the Canadian Radio Telecommunications Commission (CRTC) approved may cause the speed control to malfunction. Therefore, use only properly installed FCC approved radio transmitting equipment in your vehicle.

Features

Your vehicle has a variety of features designed for your comfort, convenience and safety. Read this chapter to find out about standard and optional features.

Doors

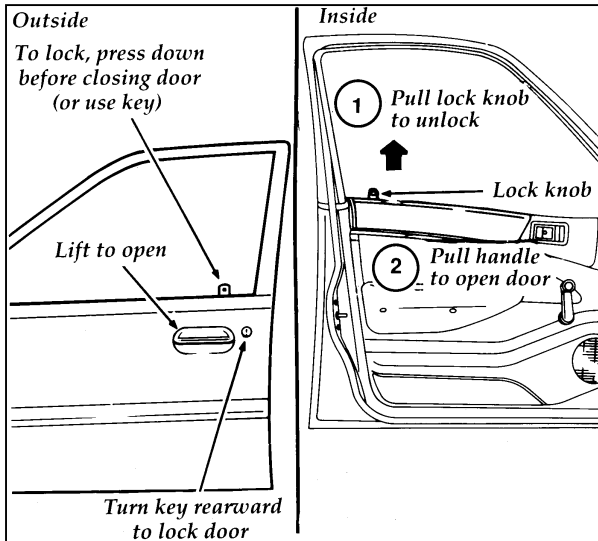

The outside and inside of doors (driver's side shown)

Power Door Locks (If equipped)

When you close the doors after you lock them with the power door locks, the doors remain locked. If the power mechanism ever fails, the manual door locks will override the power locks.

NOTE: Vehicles equipped with power locks have a safety feature which allows you to unlock one or both front doors from either door lock key cylinder.

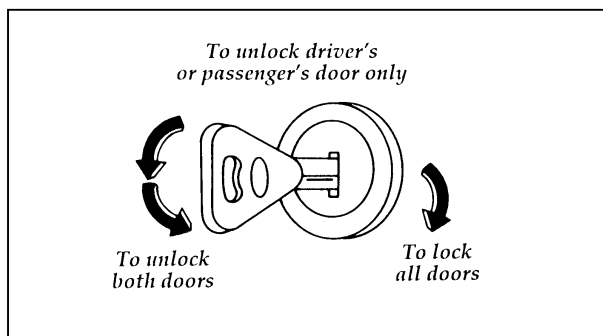

Locking and unlocking doors with the key

Childproof Locks for the Rear Doors (4-door and wagon models)

In addition to standard or power locks, your vehicle has childproof locks for the rear doors. If you set these locks, the rear doors cannot be opened from the inside of the vehicle. The doors can still be opened from the outside when the lock knobs are raised.

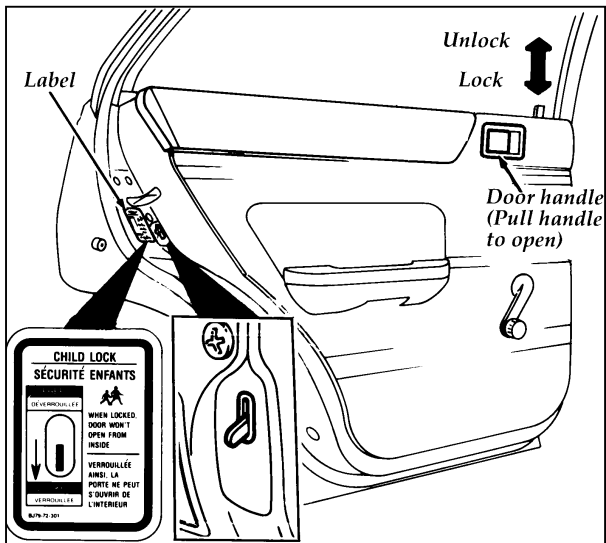

The child lock lever

To set the childproof lock on each rear door, open the rear door.

Find the lever with the word LOCKED in green letters. Move the lever down.

To release the childproof lock, open the rear door from the outside.

Move the lever up.

Windows

Operating the Windows Manually

To manually open and close the side windows, turn the hand crank.

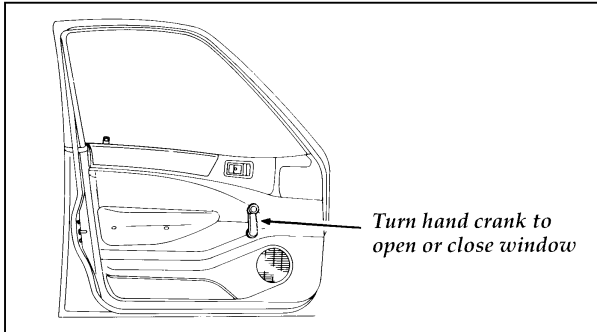

The inside of the door

Using the Power Windows (If equipped)

To use your power windows, the ignition switch must be in the ON position.

WARNING

Do not let children play with the power windows. They may seriously hurt themselves.

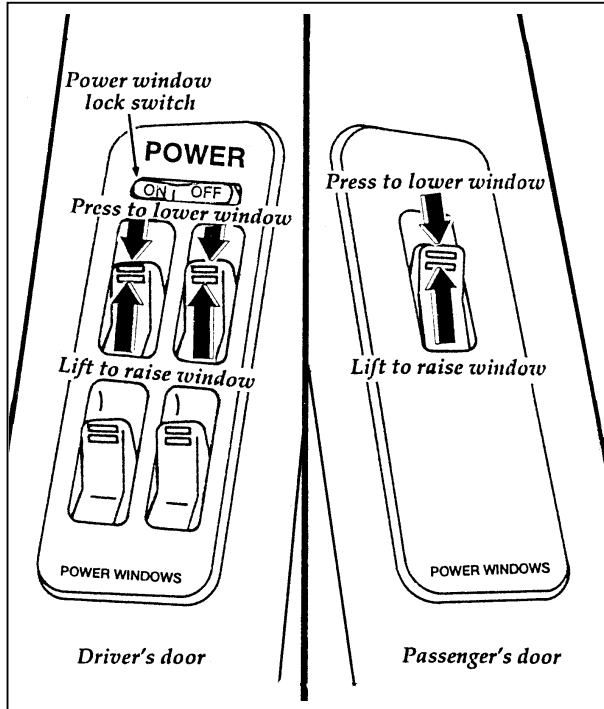

Rear Quarter Swing-out Windows (2-door hatchback models only)

The rear quarter swing-out windows may be opened or closed by releasing the window latch.

To open the window, pull the latch toward you and push the window outward until the latch snaps into the opened position.

To close the window, pull the latch toward you, then push it toward the rear of the car until it snaps shut. Make sure the window is securely closed.

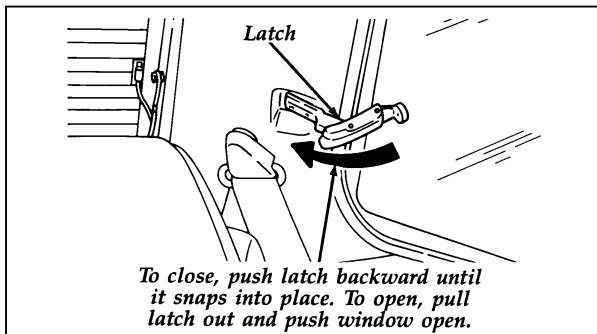

The rear quarter swing-out window

Moon Roof (If equipped)

You can move the moon roof back to open the glass panel, or you can tilt it up to ventilate the vehicle.

The roof console SLIDE switch is used to open and close the moon roof. Press and hold the switch until the desired position is reached. At the fully closed position, the motor automatically turns off.

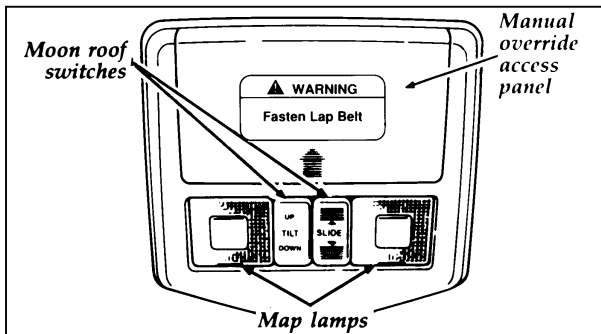

The moon roof controls

To open the moon roof, press and hold the rear portion of the switch marked SLIDE.

To close the moon roof, press and hold the front portion of the switch marked SLIDE.

To move the moon roof into the vent position when the glass panel is closed, press and hold the UP portion of the switch marked TILT.

To close the moon roof from the vent position, press and hold the DOWN portion of the switch marked TILT.

Occasionally wiping the outside guide rail covers of the moon roof with a clean cloth will help keep the moon roof working properly.

⚠ WARNING
Do not let children play with the moon roof. They may seriously hurt themselves.

To turn on a map lamp, press the map lamp switch. Press the switch again to turn the map lamp off.

What to do if the moon roof will not operate

If your moon roof becomes stuck in the open position, you may close it manually. To move the moon roof manually:

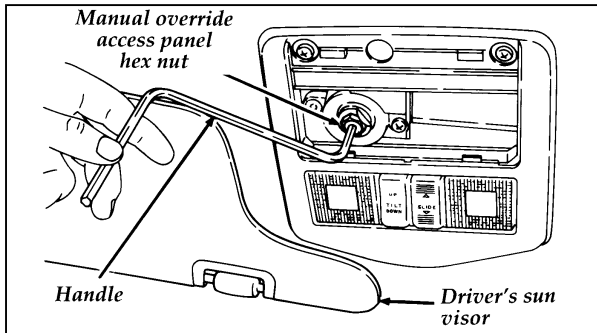

Manually operating the moon roof with the handle

1. Remove the manual override access panel from the moon roof console by sliding it rearward.
2. Find the manual override handle in the owner portfolio in the glove compartment and fit it into the hex nut in the overhead moon roof control panel.
3. Turn the handle counterclockwise to close the moon roof.

Have your moon roof serviced by a qualified technician as soon as possible.

Seats

Head Restraints

If you use them properly, head restraints are intended to help protect your head and neck in a collision.

You can adjust the front seat head restraints for your comfort and protection. The rear seat head rests do not adjust.

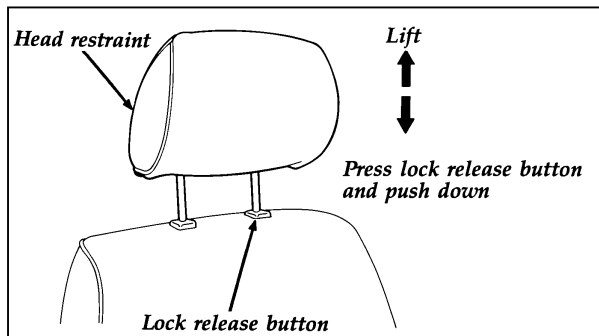

The adjusting head restraint

A head restraint helps protect you best if you position it behind your head and not behind your neck.

You can move the front seats forward or backward or tilt the backs of the seats forward or backward.

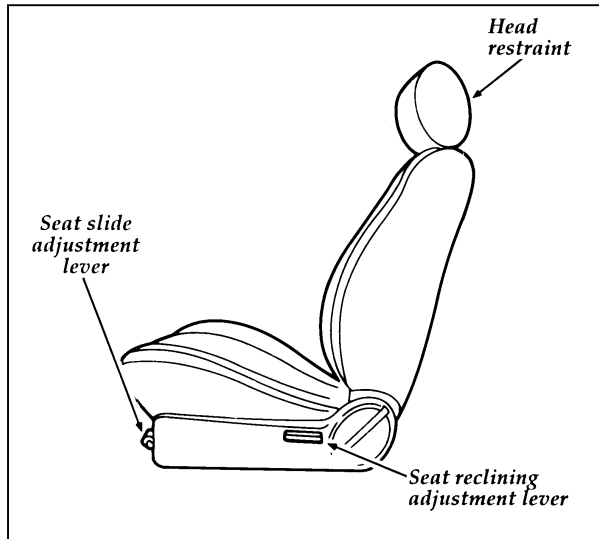

To move the seat forward or backward:

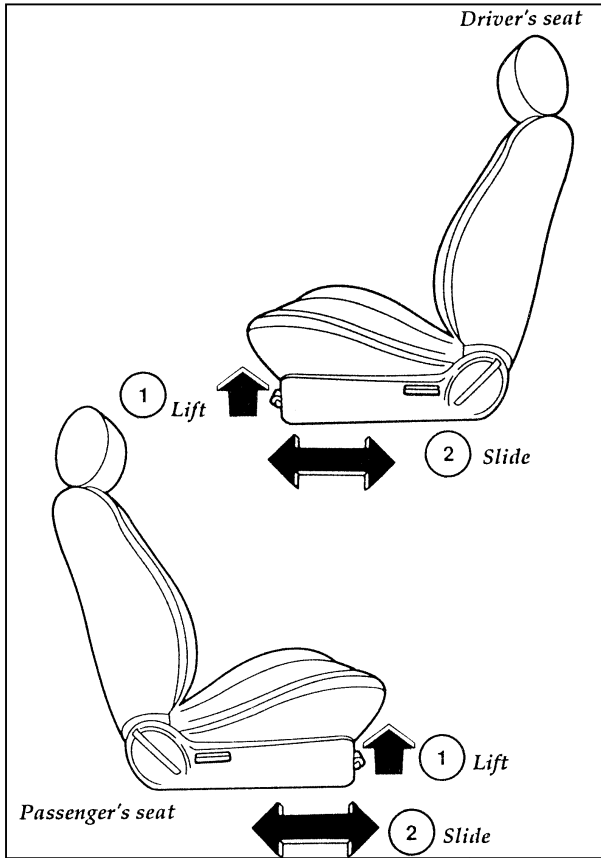

To recline the seatback:

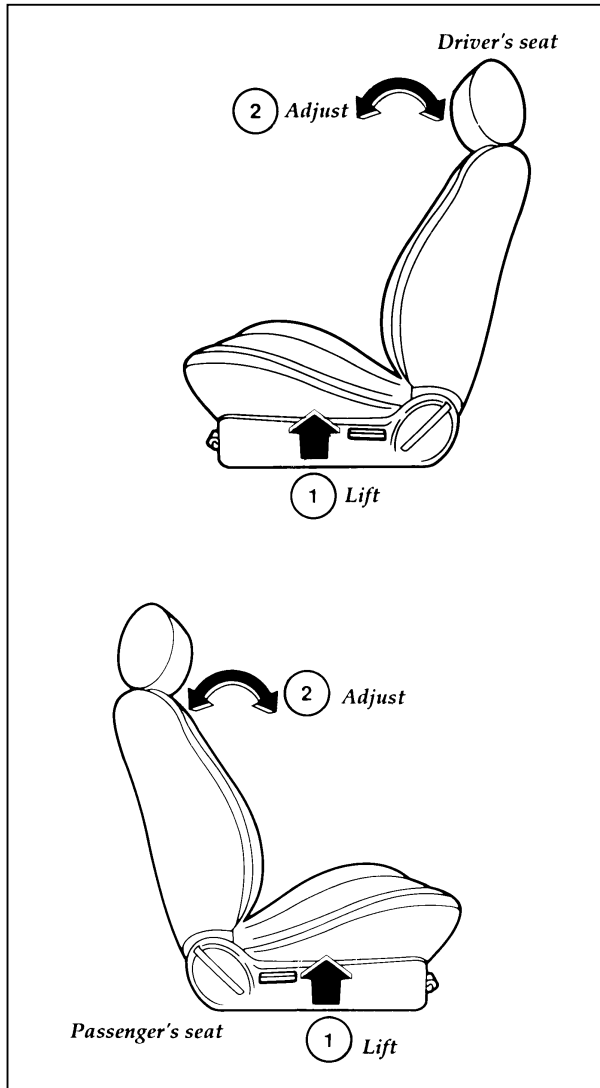

To gain access to the rear seat on the driver or passenger side (2-door version only).

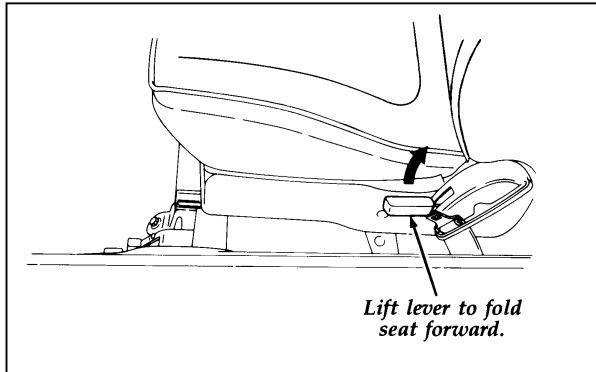

The seatback will return to its set reclined position when pushed back.

⚠ WARNING

Rear seat passengers should not lean on the front seatback while the vehicle is in motion. A seatback which is folded forward even a small degree may not lock properly in the event of a sudden stop or collision. Do not allow packages or other objects to interfere with the normal positions of the seatback or the emergency seatback release. This may prevent the seatback from locking in the event of a sudden stop or collision and could cause personal injury.

Fold-Down Rear Seats

Your vehicle is equipped with either a one-piece or split folding rear seat. The rear seatback can be folded down to provide additional cargo space.

NOTE: When folding down the rear seatback, the safety belt tongue should be disengaged.

To lower the rear seatback:

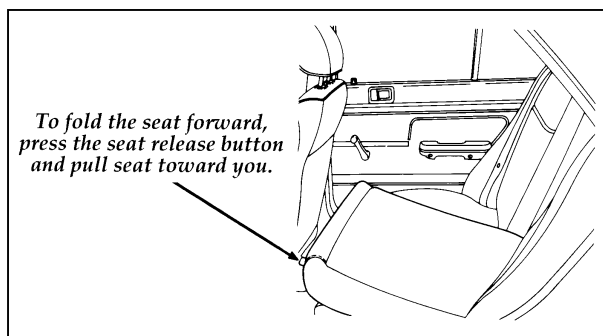

To raise the seatback, lift the seatback rearward until it latches. Make sure the seatback is locked in position by pushing it forward and backward.

⚠ WARNING

If you do not securely latch the seatback in the upright position, the seatback or objects could be thrown forward during a sudden stop or collision, possibly injuring you or other passengers.

⚠ WARNING

Luggage or other cargo should not be piled higher than the seatbacks. This will help keep items from being thrown about and injuring people in a collision or sudden stop.

⚠ WARNING

To avoid the possibility of burn injuries, do not remove the floor carpet in the cargo area. Emission controls cause high exhaust temperatures under the floor.

NOTE: When returning the folding seats to the upright position, remember to return the shoulder belts to their proper position.

Cleaning the Seats

Leather and vinyl

For routine cleaning, wipe the surface with a soft, damp cloth. For more thorough cleaning, wipe the surface with a leather cleaner or a mild soap.

Fabric

Remove dust and loose dirt with a whisk broom or a vacuum cleaner. Remove fresh spots immediately. Follow the directions that come with the cleaner.

NOTE: Before using any cleaner, test it on a small, hidden area of fabric. If the fabric's color or texture is adversely affected by a particular cleaner, do not use it.

Mirrors

You can tilt the mirror from day to night position to reduce the glare from the headlamps of vehicles behind you. Move the tab toward you for the night position and away from you for the day position.

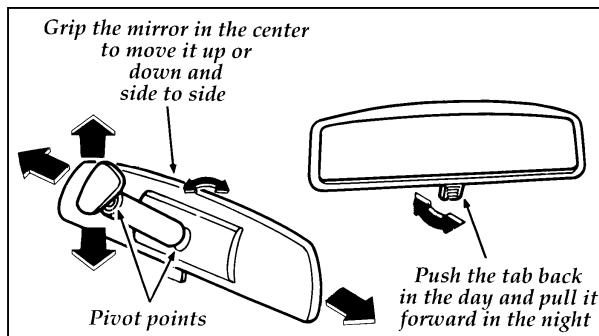

The rearview mirror

Side View Mirrors

The standard side mirror is manually adjusted by using the remote lever.

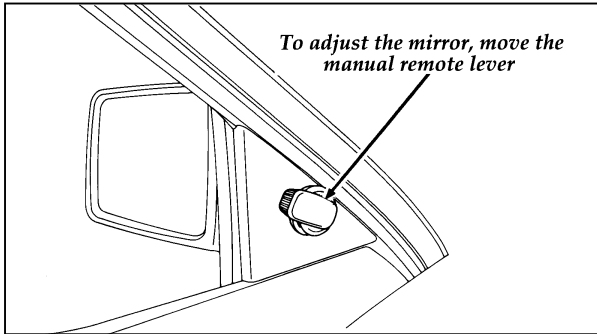

The side view mirror

Electric Remote Control Mirrors (If equipped)

If your vehicle has dual electric remote control mirrors, you can control both side view mirrors with one switch. The ignition key must be in the ACC or ON position to operate the electric remote control mirror switch.

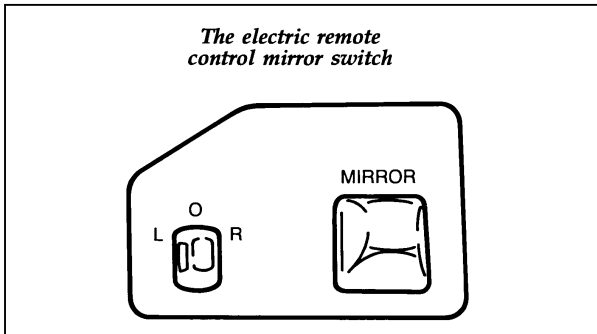

The electric remote control mirror switch

To adjust the driver-side mirror, set the mirror selection switch to the L position. To adjust the passenger-side mirror, set the selection switch to the R position.

After you choose the mirror you want to adjust, you can move the mirror in any of four directions. Move the knob in the direction you would like the mirror to move. After completing adjustment, move the switch to the center position to avoid moving the mirror by mistake.

 **WARNING**

The side view mirror on the right makes objects appear smaller and farther away than they actually are.

Do not clean the plastic housing of any rearview mirror with fuel or other petroleum-based cleaning products.

Cupholder and Tray (If equipped)

Your vehicle may have a removable cupholder and storage tray for your convenience.

If you have the removable cupholders and storage tray, they can be washed in a dishwasher.

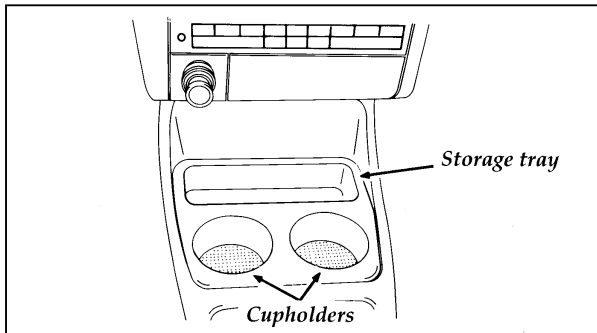

The cupholder and tray

⚠ WARNING

Use only soft cups in the cupholder. Hard objects can injure you in a collision.

Hatchback or Trunk

Using the Remote Control for the Trunk or Hatchback (If equipped)

Your vehicle may have a remote control release that allows you to open the trunk or hatchback from inside your vehicle. To release the trunk or hatchback, pull up on the release lever located on the floor between the driver's seat and the door.

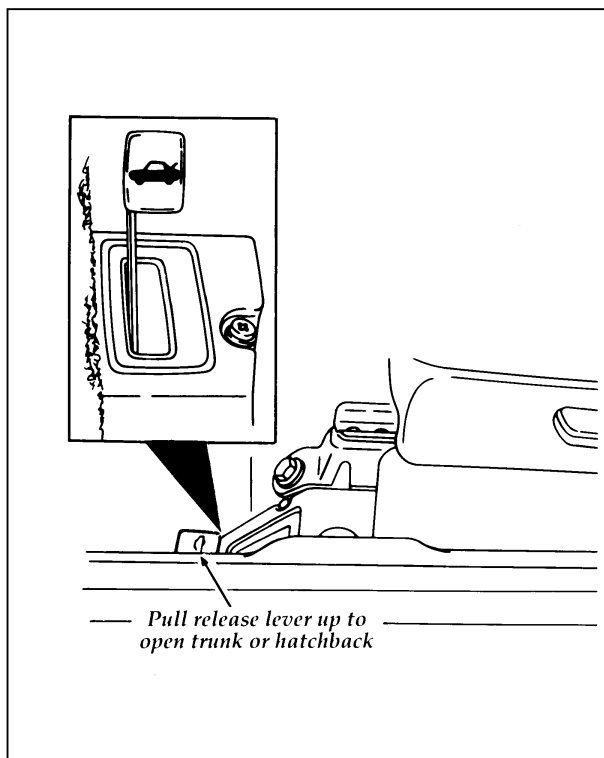

The remote control trunk release

Cargo Area Cover

This removable cover hides cargo in the luggage compartment. The cover lifts automatically when you open the hatchback.

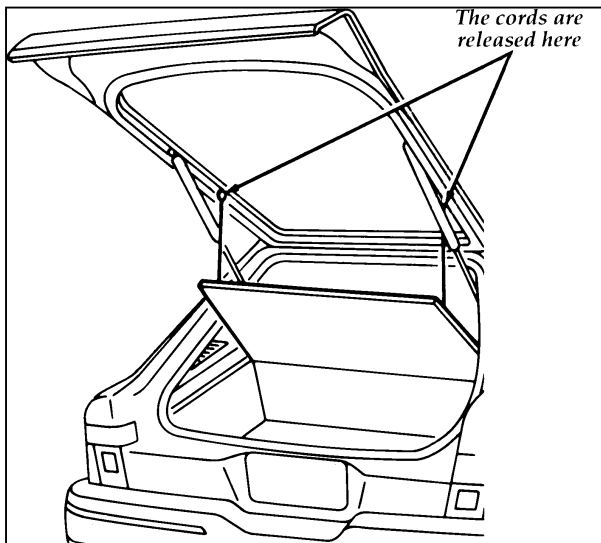

The lift cords on the hatchback

WARNING

Do not place any items on the cargo area cover. They may make it difficult to see out the window, or they could be dangerous if they strike any occupants of the vehicle in the case of a sudden stop or collision.

To remove the luggage compartment cover:

1. Raise the hatchback to the fully open position.
2. From the outside of your vehicle, unhook the looped end of the nylon lift cords from the pins in the hatchback.
3. Grasp the rear of the cargo cover and hold the cover at a 30-degree angle before sliding it out of the mounting clips.

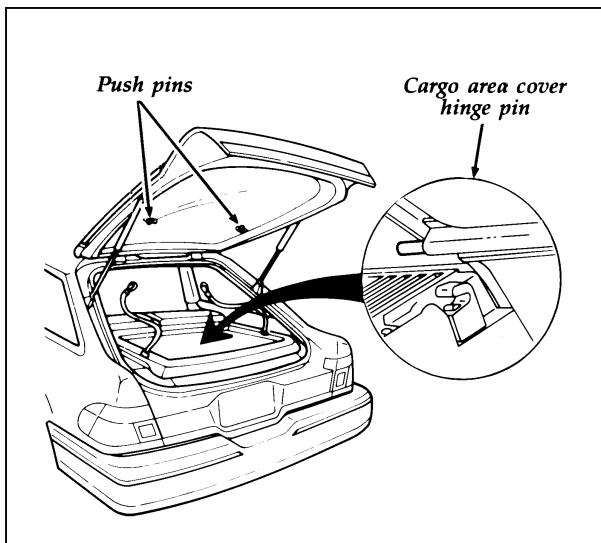

The cargo cover push pins and hinge pins

4. Remove the cargo cover from your vehicle.

⚠ WARNING

The cover may cause injury in a sudden stop or accident if it is not securely installed. Therefore, the cover should either be securely installed or removed from the vehicle. To be securely installed, the cover must be attached to the brackets and the two cords must be fastened.

To install the luggage compartment cover:

1. Raise the hatchback to the fully open position.
2. Place the cargo cover on the rear trim panels so that the hinge pins rest in front of the mounting clips behind the seatback.
3. Push the hinge pins into the mounting clips on the rear trim panel.
4. Connect the cord loops to the pins in the sides of the hatchback.
5. Close the hatchback.

⚠ WARNING

To prevent the possibility of injuries, the fasteners for the cargo area cover must be properly attached to the mounting clips on the rear trim panels.

Wagon

Sliding Shade

If you have a wagon, you have a sliding shade that you can use to hide any cargo you have in the rear storage area.

To install the shade:

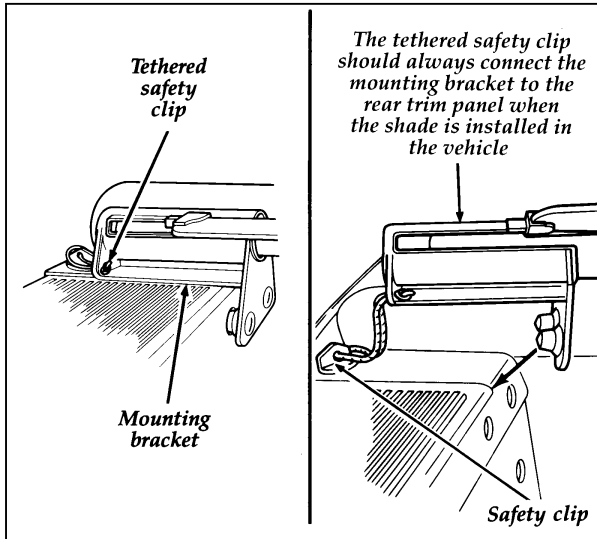

The location of the mounting brackets

1. Position the shade in the mounting brackets located behind the rear seat on each rear trim panel.

Connect the tethered safety clips as in the previous illustration. The tongue end of the shade should face the rear of your vehicle.

2. Grasp the end of the shade and pull it toward you.

- Hook the sides of the outstretched shade to notch in the rear trim panels near the liftgate opening.

⚠ WARNING

The cover may cause injury in a sudden stop or accident if it is left lying loose in the vehicle or if it is not securely installed. Therefore, the cover should either be securely installed or removed from the vehicle. To be securely installed, the cover must be attached to the brackets and to the tethered safety clips.

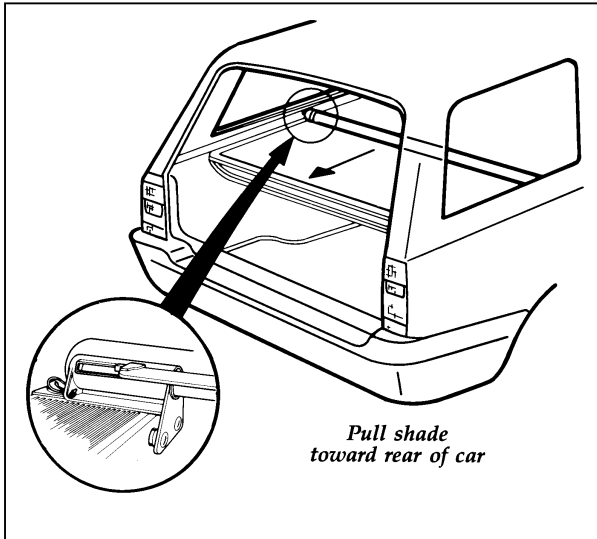

The shade

The shade is a wind-up type, just like a window shade. Over time the shade may lose its spring tension. If this happens, you can easily rewind the shade with the help of another person.

To rewind the shade:

1. Remove the shade from its side mounting brackets and take it out of your vehicle.

To remove it from your vehicle, detach the tethered mounting screws from the trim panels and push one end of the tension rod toward the opposite side of the vehicle until the shade can be removed from the mounting clips.

2. Extend the shade fully. Make sure the smooth grain side is facing you (see Figure 1).
3. Wrap the vinyl around the roller tube two times in the direction shown in Figure 1.
4. Tuck the edges of the vinyl inside the end cap with each wrap.
5. Fold the edges of the vinyl toward the center. Make sure the edges of the vinyl clear the end cap slots (see Figure 2). Use masking tape or a rubber band to hold the vinyl on the left side of the roller tube.
6. While holding the vinyl and roller tube as shown in Figure 2, push the right end cap (marked with an "R") about 1/4 inch to disengage the clutch.
7. Wind the shade 14 revolutions in the direction shown in Figure 2. (The wind direction is also marked on the end cap.)

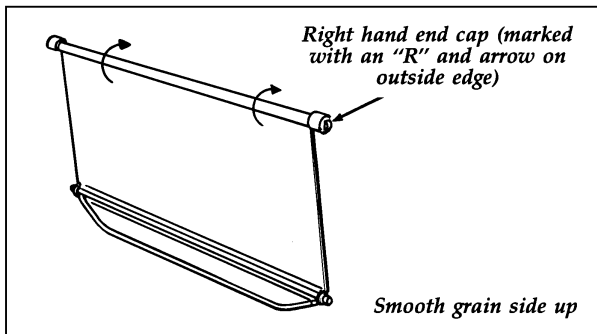

Figure 1

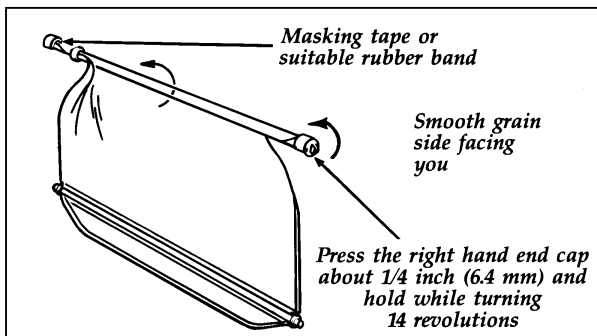

Figure 2

8. Let go of the right end cap. The clutch should now engage and stop the shade from losing its spring tension.
9. Unfold the vinyl and place it into the end cap slots.
10. With the vinyl fully wound around the roller tube, insert the shade into the side mounting brackets. **NOTE:** The opening for the right mounting bracket is narrower than the left.
11. Check to see that the shade operates properly.

Loading the Luggage Rack (If equipped - wagon model only)

If your vehicle is equipped with the optional luggage rack, load your luggage as far back as it will safely go on the rack. Do not carry more than 120 pounds (54 kg) or it may cause the vehicle to exceed the gross vehicle weight rating (GVWR) or its gross axle weight rating (GAWR front and rear), which are shown on the Safety Compliance Certification Label.

Electronic Sound Systems

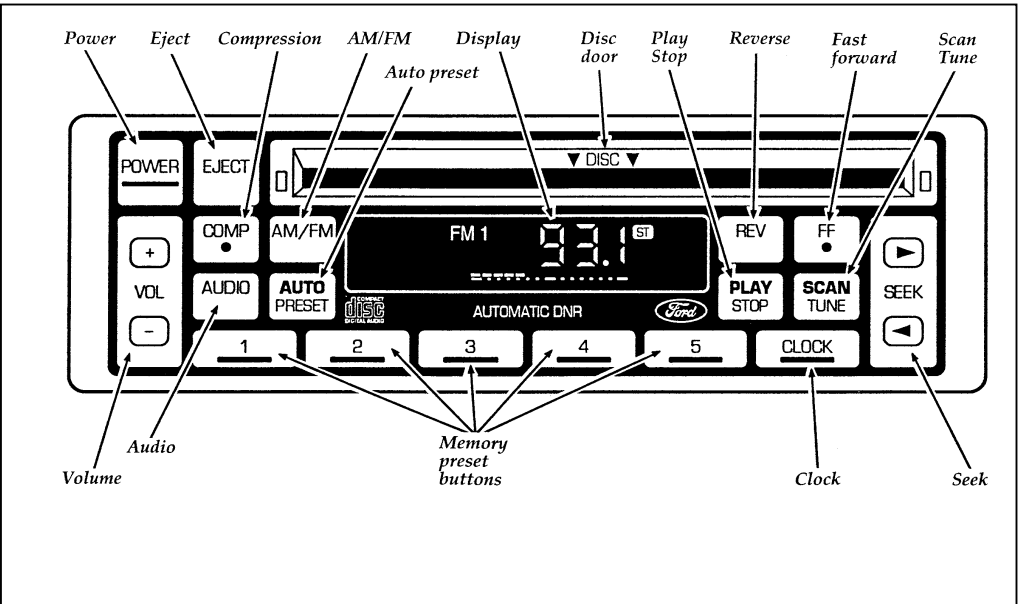

Compact Disc Radio

Compact Disc Radio

The Compact Disc Radio combines the Electronic Stereo Radio with the Ford Compact Disc Player.

Using the Controls on Your New Radio/CD Player

Most of the features of this unit work for both radio and CD operation. Also, some of the knobs and buttons control several different functions, so be sure to read all of the operating instructions carefully.

How to turn the radio on and off

Press the “POWER” button to turn the radio on. Press it again to turn it off.

How to adjust the volume

Press the +/– side of the “VOL” button to increase/decrease the volume. Bars illuminate in the display to show the relative volume level.

NOTE: If the volume level is set above a certain listening level when the ignition switch is turned off, when the ignition switch is turned back on, the volume will come back to a “nominal” listening level. However, if the radio power is turned off, the volume will remain in the position it was set at when radio power was switched off.

Selecting the AM or FM frequency band

Push the “AM/FM” button to select the desired frequency band. When in the radio mode, pushing the button more than once will alternate between AM, FM1 and FM2. These functions are used with the station memory buttons described under *How to tune radio stations*.

How to tune radio stations

There are four ways for you to tune in a particular station. You can manually locate the station using the “SCAN/TUNE” button, “SEEK” the station, “SCAN” to the station or select the station by using the memory buttons, which you can set to any desired frequency. These four methods are described below.

- Using the “SCAN/TUNE” button to manually tune

You can change the frequency up or down one increment at a time (FM changes in increments of 200kHz; AM changes in increments of 10kHz) by first pressing the “SCAN/TUNE” button twice (display shows “TUNE”), then — **within approximately five seconds** —pressing and releasing either the top ► or bottom ◀ half of the “SEEK” button. To change frequencies quickly, press and **hold down** either the top or bottom half of the “SEEK” button. While you are manually tuning, the display will show a blinking “M”.

Manual tuning adjusts your radio to any allowable broadcast frequency, whether or not a station is present on that frequency. (See *All About Radio Frequencies* in this section.)

- Using the “SEEK” function

This feature on your radio allows you to automatically select listenable stations up or down the frequency band. Press the top ► half of the “SEEK” button to select the next listenable station up the frequency band. Press the bottom ◀ half of the button to select the next listenable station down the frequency band. By pressing and holding the button, listenable stations can be passed over to reach the desired station.

- Using the “SCAN/TUNE” button to scan radio stations

Pressing the “SCAN/TUNE” button once enters the scan mode (display will indicate “SCN”). Pushing the top ► half of the “SEEK” button will begin the scan mode up the frequency band, stopping on each listenable station for approximately five seconds. Pushing the bottom ◀ half of the “SEEK” button will begin the scan mode down the frequency band, again stopping on each listenable station for approximately five seconds.

To stop the scan mode on the presently sampled station press the “SCAN/TUNE” button again.

- Setting the Station Memory Preset buttons

Your radio is equipped with 5 station memory buttons. These buttons can be used to select up to 5 preset AM stations and 10 FM stations (5 in FM1 and 5 in FM2). Follow the easy steps below to set these buttons to the desired frequencies.

1. Select a band, then select a frequency.
2. Press one of the memory preset buttons and hold the button until the sound returns. That station is now held in memory on that button.
3. Follow the two steps above for each station memory preset button you want to set.

□ Using the Automatic Memory Load feature

If no stations are in memory preset, you can activate the **Auto Memory Load** feature by pressing and holding the “AUTO PRESET” button **for approximately three seconds**.

Auto Memory Load sets all memory buttons in AM, FM1 and FM2 sequentially by seeking out the first six strong stations for the respective band and storing them in memory buttons 1-5. (FM2 will store the second set of strong stations from the FM band.)

With Auto Memory Store, you can continually set strong stations into your memory buttons without losing your existing memory presets, which is especially handy while traveling. Your radio will automatically set your memory buttons to the strong local stations so you don't have to continually manually tune to existing stations.

Activate Auto Memory Store by pushing the “AUTO PRESET” button once. Your radio will set the first five strong stations of the band you are in (AM, FM1 or FM2) into the memory buttons. The display will show “AUTO,” then run through the frequencies, stopping momentarily on the stations being set into the memory buttons. The radio is now in the “AUTO” mode and the display will show “AUTO” each time a preset is activated.

NOTE: If there are fewer than five strong stations in the frequency band, the remaining unfilled buttons will store the last strong station detected on the band.

After all stations have been filled, the radio will begin playing the station stored on memory button 1.

To deactivate the Auto Memory Store mode and return to the manually-set memory button stations (or those stations set using Auto Memory Load), simply push the “AUTO PRESET” button. Display will show “AUTO” then “OFF.” The next time Auto Memory Store is activated on that band, the radio will store the next set of five strong stations.

Using the “AUDIO” button to adjust the tone balance and speaker output

Increasing or decreasing bass response

Push the “AUDIO” button repeatedly until the display reads “BASS.” Push the “+” side of the “VOL” button to increase bass (more “lows”), and push the “-” side to decrease bass (less “lows”).

Increasing or decreasing treble response

Push the “AUDIO” button repeatedly until the display reads “TREB.” Push the “+” side of the “VOL” button to increase treble (more “highs”), and push the “-” side to decrease treble (less “highs”).

Adjusting speaker balance

Balance control allows you to adjust the sound distribution between the right and left speakers. Push the “AUDIO” button repeatedly until the display reads “BAL.” Push the “+” side of the “VOL” button to shift the sound to the right speakers, and push the “-” side to shift the sound to the left speakers.

□ Adjusting speaker fader

Fade control allows you to adjust the sound distribution between the front and rear speakers. Push the “AUDIO” button repeatedly until the display reads “FADE.” Push the “+” side of the “VOL” button to shift the sound to the front speakers, and push the “-” side to shift the sound to the rear speakers.

NOTE: Illuminated bars in the display show relative levels of bass and treble and positions of speaker balance and fader functions after adjustments are made, then revert to volume level set.

Clock Operation

When in the radio mode, push the “CLOCK” button to switch from radio frequency to clock. Only the clock numerals will be displayed in the clock mode — there is no A.M./P.M. indication. When in the clock mode, the time will be displayed until the button is pushed again. However, if you retune the radio while it is in the clock mode, the new radio frequency will be displayed for approximately ten seconds and then change back to clock.

When in the CD mode, push the “CLOCK” button to change the display from elapsed time mode to track number mode to clock mode. If the CD track selection is changed when you are in the clock or elapsed time mode, the new track number will be displayed for approximately ten seconds and then revert back to the previous mode.

The clock can also be viewed with the ignition off. Push the “CLOCK” button and the time will be displayed momentarily.

To set the clock, simultaneously press the “CLOCK” button and either the bottom (◀) half of the “SEEK” button to set hours, or the top (▶) half of the “SEEK” button to set minutes.

NOTE: The clock can be set with the radio and/or ignition on or off.

Using the Controls on Your New Compact Disc Player

Your new Ford Compact Disc Player is capable of playing 12 cm *or* 8 cm discs, without an adapter. The Player operates when the power is on and a disc is inserted (**label side up**). Handle the disc by its edge only. (Be sure to read and follow all of the care and cleaning instructions under *How To Take Care of and Clean Your CD Player and Discs*.)

NOTE: If after you insert a disc, the disc is ejected and “ERROR” begins scrolling in the display, remove the disc and reinsert it right side up (label side up).

The digital display on your CD player will either show the track (selection) number or the elapsed time. (The display mode can be selected by pressing the “CLOCK” button.) Indicators for play (▶), stop (■) and compression on (“C”) are also in the display. (These features are described later.)

Once a disc is inserted, operation of the CD player will override that of the radio.

NOTE: The volume, bass, treble, balance and fader controls on the radio are also used with the CD player. Refer to earlier operating instructions on these controls.

How to insert a disc and begin play

Insert one disc, **label side up** into the disc opening. When inserted, the disc automatically loads into the unit and play starts at the beginning of the first track (selection).

When the disc reaches the end, the disc player automatically returns to the beginning of the disc and resumes playing.

NOTE: Once a disc is inserted, the disc opening is secured to prevent the accidental insertion of a second disc.

NOTE: The CD player has heat protection circuitry to protect the laser diode. If the temperature of the player reaches 167°F (75°C), the heat detection circuit will shut off the player and “TOO HOT” will scroll in the display for approximately five seconds (radio will resume playing). When the temperature returns to normal operating range, the CD player will again be operational.

How to stop and restart the CD player

When a disc is loaded, the unit automatically enters the play mode and the play indicator ► illuminates. To stop temporarily, press the “PLAY/STOP” button or the “AM/FM” button. The stop indicator ■ in the display illuminates and operation returns to the radio mode. To resume CD play, press the “PLAY/STOP” button once again.

NOTE: If the ignition key is turned OFF during play and then is set to the ON or ACCESSORY position, the CD player will resume playing in the mode it was in when ignition was turned off.

How to fast forward or reverse your CD player

To quickly search for a particular point in a selection, press the “FF” button (to fast forward) or the “REV” button (to reverse). While either button is pressed, the disc goes forward or backward at two different speeds depending on how long the button is held down. (Pressing either button for more than three seconds will speed up the process.) Release the button at the desired point (found by watching the elapsed playing time in the display or by listening to the sound during fast forward or reverse). When you have reached the beginning of track 1, the CD player will begin playing.

When you have reached the end of the disc by keeping the fast forward button pressed, the display will show “END” and the player will go into pause mode. Push the “PLAY/STOP” button to begin playing the first track of the disc, press the “REV” button to back up from the end of the disc, or use the “SEEK” function to locate a desired track.

Using the “SEEK” feature

The “SEEK” feature allows you to quickly find a particular selection on the disc.

Press the bottom (◀) half of the “SEEK” button once to repeat the current playing selection. Press the top (▶) half of the “SEEK” button to advance to the next selection.

Pressing and holding the bottom (◀) or top (▶) half of the “SEEK” button will scroll backward and forward respectively through the tracks.

Using the “SCAN” function

Press the “SCAN/TUNE” button to enter the scan mode. Once in the scan mode, press the top (▶) or bottom (◀) half of the “SEEK” button to scan forward or reverse, respectively. The CD player will begin scanning the disc, stopping on each listenable track for approximately eight seconds. This continues until you press the “SCAN/TUNE” button a second time. While in the scan mode, the display shows the current sampled track number.

Special features of your CD player

Compression

The compression feature will bring soft and loud passages closer together for a more consistent listening level.

To turn the compression on, press the “COMP” button. When on, the compression indicator (“C”) will appear in the display. Press the button again to turn off.

Automatic Disc Storage

If the disc is ejected from the CD player but is not removed from the disc opening within approximately 10 seconds, the player will automatically reload the disc for storage, unless the disc is automatically ejected due to a “focus error” (disc inserted upside down). In this case, the disc will not be automatically reloaded.

How to eject the disc

Push the "EJECT" button to stop play, eject the disc and resume radio operation of your audio system.

NOTE: You can eject the disc while the radio power and/or ignition is on or off.

How To Take Care of and Clean Your CD Player and Discs

To ensure the continued performance of your Ford Compact Disc Player, carefully read the following precautions:

- Always handle the disc by its edge. Never touch the playing surface.
- Before playing, inspect the disc for any contamination. If needed, clean the disc with an approved disc cleaner, such as the Discwasher® Compact Disc Cleaner or the Allsop 3® Compact Disc Cleaner, by wiping from the center out to the edges. **Do not use a circular motion to clean.**
- Do not clean discs with solvents such as benzene, thinner, commercially available cleaners or antistatic spray intended for analog records.
- Do not expose the disc to direct sunlight or heat sources such as defroster and floor heating ducts. Do not leave any discs in a parked car in direct sunlight where there may be a considerable rise in temperature or damage may result.

- After playing, store the disc in its case.
- If a disc has already been inserted, do not try to insert another disc. Doing so may damage the disc player.
- Do not insert anything other than a disc into the disc player.

CAUTION: The use of optical instruments with this product will increase eye hazard as the laser beam used in this compact disc player is harmful to the eyes. Do not attempt to disassemble the case. Refer servicing to qualified personnel only.

Common Operating Conditions of Your CD Player

The following information is designed to help you recognize typical situations that could be mistakenly interpreted as mechanical malfunctions of the disc player.

- A disc is already loaded.
- The disc is inserted with the label surface downward.
- The disc is dusty or defective.
- The player's internal temperature is above 140°F (60°C). Allow the player to cool off before operating.

- Different manufacturers of compact discs may produce discs with different dimensions or tolerances, some of which may not be within industry standards or in accordance with the CD format. Because of this, a new disc that is free of dust and scratches could be defective and may not play on your Ford Compact Disc Player.

If play does not begin after the CD button is pushed:

- The radio is not on.
- The unit is in the stop mode.
- Moisture may have condensed on the lenses within the unit. If this occurs, remove the disc and wait approximately an hour until the moisture evaporates.

If the sound skips:

- Badly scratched discs or extremely rough roads will cause the sound to skip. Skipping will not damage the disc player or scratch the discs.

Electronic Stereo Radio

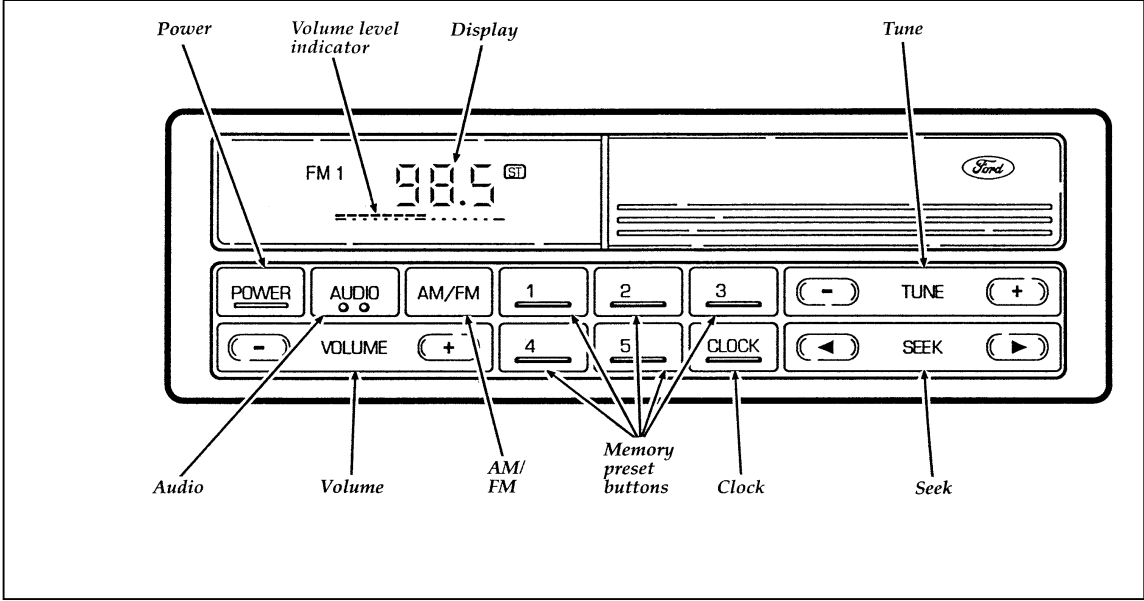

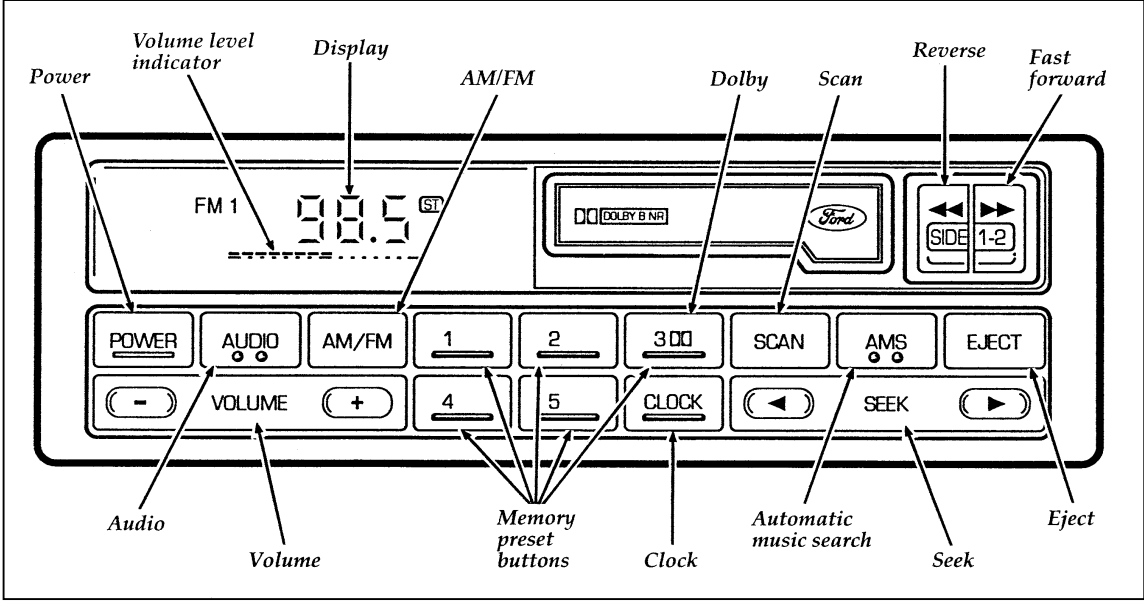

Electronic Stereo Radio with Cassette

Electronic Stereo and Stereo Cassette Radios

Using the Controls on Your New Radio

How to turn the radio on and adjust the volume

Press the “POWER” button to turn the radio on. Press it again to turn it off.

Press the right (+) side of the “VOLUME” button to increase the volume. Press the left (-) side of the button to decrease the volume. Illuminated bars in the display show the relative volume level.

Selecting the AM or FM frequency band

Push the “AM/FM” button to select the desired frequency band. Pushing the button more than once will alternate between AM, FM1 and FM2. These functions are used with the station memory buttons described under *How to tune radio stations*.

How to tune radio stations (Stereo Radio)

There are three ways for you to tune in to a particular station. You can manually locate the station by using the “TUNE” button, “SEEK” the station or select the station by using the memory preset buttons, which you can set to any desired frequency.

How to tune radio stations (Stereo Cassette Radio)

There are four ways for you to tune in to a particular station. You can manually locate the station by using Automatic Music Search (“AMS”), “SEEK” the station, “SCAN” to the station or select the station by using the memory buttons, which you can set to any desired frequency.

Using the “TUNE” function (Stereo Radio)

You can change the frequency up or down one increment at a time by pressing and releasing either the right (+) or left (–) side of the “TUNE” button. To change frequencies quickly, press and hold down either the right or left side of the “TUNE” button.

Using the “AMS” function to manually tune your radio (Stereo Cassette Radio)

You can change the frequency up or down one increment at a time by first pressing the “AMS” button (display shows “TUNE”) then within approximately five seconds pressing and releasing either the right ► or left ◀ side of the “SEEK” button. To change frequencies quickly, press and **hold down** either the right or left side of the “SEEK” button.

Manual tuning adjusts your radio to any allowable broadcast frequency, whether or not a station is present on that frequency. (See *All About Radio Frequencies* in this section.)

Using the “SEEK” function

This feature on your radio allows you to automatically select listenable stations up or down the frequency band. Press the right ► side of the “SEEK” button to select the next listenable station up the frequency band. Press the left ◀ side of the button to select the next listenable station down the frequency band. By holding the button down, listenable stations can be passed over to reach the desired station.

Using the “SCAN” function (Stereo Cassette Radio)

Press the “SCAN” button to enter the scan mode. The radio will begin scanning up the frequency band, stopping on each listenable station for approximately a five-second sampling. This continues until you press the “SCAN” button a second time.

Setting the Station Memory Preset buttons

Your radio is equipped with 5 station memory buttons. These buttons can be used to select up to 5 preset AM stations and 10 preset FM stations (5 in FM1 and 5 in FM2).

Follow the easy steps below to set these buttons to the desired frequencies:

1. Select a band, then select a frequency.
2. Press one of the memory preset buttons and hold the button until the sound returns. That station is now held in memory on that button.
3. Follow the two steps above for each station memory preset button you want to set.

NOTE: If the vehicle's battery is disconnected, the clock and station memory preset buttons will need to be reset.

Adjusting the tone balance and speaker output of your radio

- Increasing or decreasing bass response

Push the "AUDIO" button repeatedly until the display reads "BASS." Push the "+" side of the "VOLUME" button to increase bass (more "lows"), and push the "-" side to decrease bass (less "lows").

- Increasing or decreasing treble response

Push the "AUDIO" button repeatedly until the display reads "TREB." Push the "+" side of the "VOLUME" button to increase treble (more "highs"), and push the "-" side to decrease treble (less "highs").

Speaker features and operation

- Adjusting speaker balance

Balance control allows you to adjust the sound distribution between the right and left speakers. Push the "AUDIO" button repeatedly until the display reads "BAL." Push the "+" side of the "VOLUME" button to shift the sound to the right speakers, and push the "-" side to shift the sound to the left speakers.

- Adjusting speaker fader

Fade control allows you to adjust the sound distribution between the front and rear speakers. Push the "AUDIO" button repeatedly until the display reads "FADE." Push the "+" side of the "VOLUME" button to shift the sound to the front speakers, and push the "-" side to shift the sound to the rear speakers.

Using the Controls of Your Cassette Tape Player

How to insert a tape

Insert a cassette (with the open edge to the right) firmly into the tape door opening, making sure the cassette is completely in and “seated.”

How to locate a desired track on the tape

NOTE: The tape track or side number indicated in the display does not necessarily correspond to the tape track or side number on the cassette label. It is used only to indicate when the tape mechanism reverses tracks.

- Using the Automatic Music Search (“AMS”) function with cassette tape player

Press and hold the “AMS” button (“AMS” will appear in the display). Then, push the left ◀◀ button to rewind to the beginning of the current selection or press the right ▶▶ button to fast forward to the beginning of the next selection.

- Fast forwarding the tape

Push the right ▶▶ button to fast forward the tape.

- Rewinding the tape

Push the left ◀◀ button to rewind the tape.

- How to change the side of the tape being played

The alternate track (other side) of the tape can be selected at any time by pushing both fast-wind buttons (◀◀ and ▶▶) at the same time. The number in the display will alternate between 1 and 2.

How to eject the tape

To stop the tape and eject the cassette, press the “EJECT” button. The radio will resume playing.

Using the Dolby® B noise reduction feature

NOTE: Noise reduction system manufactured under license from Dolby Labs Licensing Corporation. “Dolby” and double-D symbol are trademarks of Dolby Laboratories Licensing Corporation.

Push the /memory preset #3 button to activate. Push again to deactivate.

Clock Operation

How to view the clock mode

Press the “CLOCK” button to alternate the frequency and time in the display. In the clock mode, pressing any radio function will automatically display the radio frequency for approximately ten seconds before changing back to the clock mode.

How to set the clock

1. Turn the radio on.
2. Press and hold in the “CLOCK” button, press the “SEEK” button left (◀) to advance the hours and right (▶) to advance the minutes.

NOTE: The clock displays 12-hour time with no AM/PM indications.

Tips on Caring for the Cassette Player and Tapes

In order to keep your cassette tape player performing the way it was meant to, read and follow these simple precautions:

- Only cassettes that are 90 minutes long or less should be used. Tapes longer than 90 minutes are thinner and subject to breakage or may jam the tape player mechanism.
- Protect cassettes from exposure to direct sunlight, high humidity and extreme heat or cold. If they are exposed to extreme conditions, allow them to reach a moderate temperature before playing.
- Loose labels on cassette tapes can become lodged in the mechanism. Remove any loose label material before inserting a cassette.
- If a tape is loose inside the cassette, tighten it before playing by putting your finger or a pencil into one of the holes and turning the hub until the tape is tight.
- Do not leave a tape in the cassette tape player when not in use. High heat in the vehicle can cause the cassette to warp.
- Using a Ford Cassette Cleaning Cartridge to clean the tape player head after 10-12 hours of play will help maintain the best playback sound and proper tape operation.

Common Radio Reception Conditions

Several conditions prevent FM reception from being completely clear and noise-free, such as the following:

1. Distance/Strength

The strength of the FM signal is directly related to the distance the signal must travel. The listenable range of an average FM signal is approximately 25 miles (40 kilometers). Beyond this distance, the radio is operating in a fringe area and the signal becomes weaker.

2. Terrain

The terrain (hilly, mountainous, tall buildings) of the area over which the signal travels may prevent the FM signal from being noise-free.

If there is a building or large structure between the antenna and station, some of the signal “bends” around the building, but certain spots receive almost no signal. Moving out of the “shadow” of the structure will allow the station to return to normal.

When the radio waves are reflected off objects or structures, the reflected signal cancels the normal signal, causing the antenna to pick up noise and distortion. Cancellation effects are most prominent in metropolitan areas, but also can become quite severe in hilly terrain and depressed roadways.

To minimize these conditions, a stereo/mono blend circuit has been incorporated into this system. This feature automatically switches a weak stereo signal to a clearer monaural signal, which improves the quality of reception.

Several sources of static are normal conditions on AM frequencies. These can be caused by power lines, electric fences, traffic lights and thunderstorms.

Another reception phenomenon is **Strong Signal Capture and Overload**. This can occur when listening to a weak station and when passing another broadcast tower. The close station may capture the more distant station, although the displayed frequency does not change. While passing the tower, the station may switch back and forth a few times before returning to the original station.

When several broadcast towers are present (common in metropolitan areas) several stations may overload the receiver, resulting in considerable station changing, mixing and distortion.

Automatic gain control circuitry for both AM and FM bands has been incorporated into this system to reduce strong signal capture and overload.

All About Radio Frequencies

Not all frequencies will be assigned to a given area. This radio will tune to each of these frequencies using manual tune and no fine tuning is necessary as radio stations may not use other frequencies.

Some FM radio stations advertise a “rounded-off” frequency which is not the frequency they actually broadcast on. For example, a radio station that is assigned a frequency of 98.7 MHz may call itself “Radio 99” even though 99.0 MHz is not an allowable FM broadcast frequency.

Important Warranty and Service Information

Your sound system is warranted for three years or 36,000 miles (60,000 kilometers), whichever comes first. Consult your vehicle warranty booklet for further information. Ask your dealer for a copy of this limited warranty.

At Ford Electronics, we stand behind our audio systems with a comprehensive service and repair program. If anything should go wrong with your Ford audio system, return to your dealer for service. There is a nationwide network of qualified Ford authorized repair centers to assist you.

Driving Your Escort

Procedures for driving your vehicle will vary depending on which type of *transaxle* your vehicle has. You may be familiar with the term “transmission.” We use *transaxle* because it is a more accurate term for vehicles that have front-wheel drive.

Your vehicle will have one of the following types of transaxles:

- an automatic overdrive transaxle, or
- a manual transaxle.

Your vehicle is equipped with an Electronic Engine Control Module that limits engine speeds with a cut-out mode to promote durability.

Driving with an Automatic Overdrive Transaxle

Your automatic overdrive transaxle provides fully automatic operation in either **D** (Overdrive) or **D** (Drive). Driving with the shift selector in **D** (Overdrive) gives the best fuel economy for normal driving conditions. For manual control, start in **L** (Low) and then shift manually.

Putting Your Vehicle in Gear

WARNING

Hold the brake pedal down while you move the gearshift lever from position to position. If you do not hold the brake pedal down, your vehicle may move unexpectedly and injure someone.

Using a Console-Mounted Gearshift

Since your vehicle has a console-mounted gearshift, you must depress the brake pedal, then push in the thumb button to move the gearshift to the position you choose.

Once the gearshift is secure in the desired position, release the brake pedal and use the accelerator as necessary.

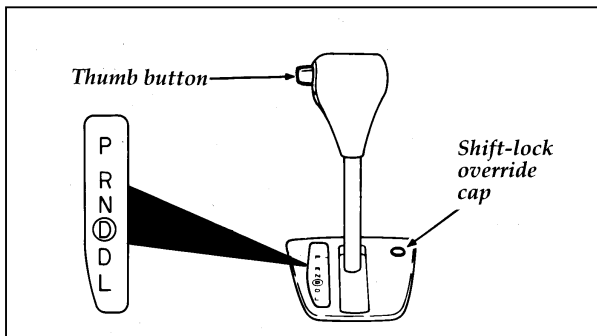

The automatic console-mounted gearshift lever

To move the gearshift out of P (Park), the ignition must be turned to the ON position and the brake pedal must be depressed. When the gearshift is in any other position except P (Park), the ignition key cannot be turned to LOCK or be removed from the steering column. To remove the key, the gearshift **must** be in P (Park).

Your vehicle has a special shift-lock safety feature which prevents you from shifting out of P (Park) without the brake pedal depressed. To shift the transaxle out of the P (Park) position, the ignition must be in the ON position, the battery must be supplying electrical power, and your foot must be pressing on the brake pedal.

In the unlikely event that you cannot move the selector lever from the P (Park) position with the brake pedal depressed, continue depressing the brake. Then:

1. Remove the shift-lock override cap with a 1" or longer screwdriver.

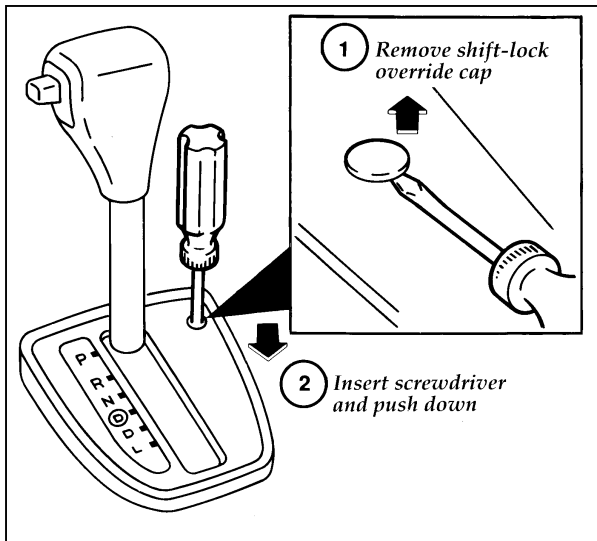

Shift-lock override

2. Insert the screwdriver into the shift-lock override opening and push the screwdriver handle down.

NOTE: You may use the override handle provided in your Owner Guide portfolio in place of a screwdriver.

3. Push and hold the thumb button.
4. Move the gearshift lever.

If you need to shift out of P (Park) by using the alternate procedure described above, it is possible that a fuse has blown and that your brakelamps may also not be functional. Please refer to the chapter titled *Servicing Your Escort* in this Owner Guide for instructions on checking and replacing fuses.

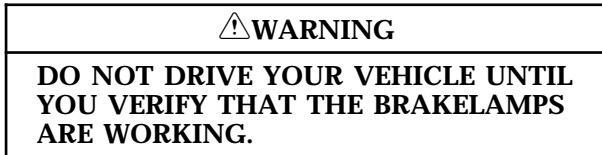

Driving

When to use **D** **(Overdrive)**

D (Overdrive) is the usual driving position for an automatic overdrive transaxle. It works the same way D (Drive) works, automatically upshifting or downshifting as the vehicle speeds or slows.

However, **D** (Overdrive) also shifts into a fourth gear — an overdrive gear — when your vehicle cruises at a consistent speed for any length of time. This fourth gear will increase your fuel economy when you travel at cruising speeds.

D (Overdrive) may not be appropriate for certain terrain. If the transaxle shifts back and forth between third and fourth gears while you are driving on hilly roads or if your vehicle requires additional power for climbing hills, shift to D (Drive).

When to use D (Drive)

D (Drive) eliminates the excessive shifting between third and fourth gears that your vehicle sometimes does when you are traveling through hilly terrain in **D** Overdrive. It also gives more engine braking to slow your vehicle on downgrades than **D** Overdrive.

When to use L (Low)

Use L (Low) when more power is needed to drive up steep hills. It also gives more engine braking than Drive when driving on hilly roads.

Do not go faster than 38 mph (60 km/h) in this gear. You can upshift from L (Low) to Drive or from L (Low) to Overdrive at any speed.

Reverse

With the gearshift in the R (Reverse) position, the vehicle will move backward. You should always come to a complete stop before shifting into or out of R (Reverse).

Neutral

In N (Neutral), the wheels of the transaxle are not locked. Your vehicle will roll freely, even on the slightest incline, unless the parking brake or brakes are on.

Parking

Always come to a complete stop before you shift into P (Park). Make sure that the gearshift is securely latched in P (Park). This locks the transaxle and prevents the front wheels from rotating.

 WARNING
--

Always set the parking brake fully and make sure the gearshift is securely latched in P (Park).
--

 WARNING
--

Never leave your vehicle unattended while it is running.

You can tell the gearshift is securely latched when the thumb button has popped out. In this position the gearshift selector lever cannot be moved unless the button is pushed in.

 WARNING
--

Hold the brake pedal down while you move the gearshift lever from position to position. If you do not hold the brake pedal down, your vehicle may move unexpectedly and injure someone.
--

Driving with a Manual Transaxle

Using the Clutch

In order to start the vehicle, the clutch pedal must be fully depressed to the floor. Before starting the engine, make sure the vehicle is in Neutral and the parking brake is set.

Do not drive with your foot resting on the clutch pedal and do not use the clutch to hold your vehicle at a standstill while waiting on a hill. These actions will seriously reduce clutch life.

Shifting the Gears

The gearshift for a manual transaxle is mounted on the floor. The gearshift can be in one of seven possible positions, as shown.

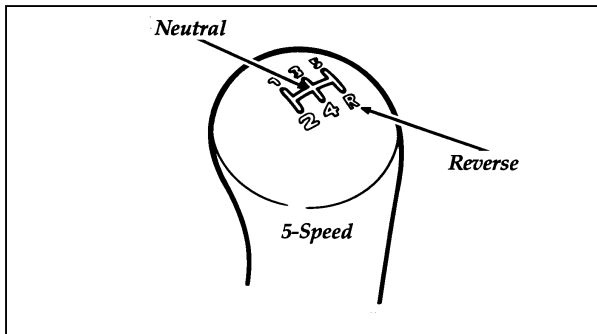

The positions of the floor-mounted gearshift

Backing up

To shift into R (Reverse):

1. Completely stop your vehicle.
2. Depress the clutch pedal to the floor and place the gearshift lever in the Neutral position. Do not release the clutch pedal.

3. Push the gearshift lever completely to the right and then pull rearward on the gearshift lever to engage the Reverse gear.
4. If the Reverse gear is engaged, slowly release the clutch pedal from the floor.
5. If the Reverse gear is not engaged, do not release the clutch pedal from the floor. Place the gearshift lever back in Neutral and then momentarily release the clutch pedal from the floor.
6. Repeat steps 2 through 4.

Upshifting

For normal acceleration, you should upshift at the following speeds:

	1.8 liter engine	1.9 liter engine
1 to 2	11 mph (18 km/h)	12 mph (19 km/h)
2 to 3	24 mph (39 km/h)	22 mph (35 km/h)
3 to 4	34 mph (55 km/h)	31 mph (50 km/h)
4 to 5	43 mph (69 km/h)	42 mph (68 km/h)

For cruising, you should upshift at the following speeds:

	1.8 liter engine	1.9 liter engine
1 to 2	10 mph (16 km/h)	11 mph (18 km/h)
2 to 3	17 mph (27 km/h)	17 mph (27 km/h)
3 to 4	29 mph (47 km/h)	25 mph (40 km/h)
4 to 5	39 mph (63 km/h)	35 mph (56 km/h)

Upshift indicator light (If equipped)

After the engine warms up, the upshift light will come on if you could get better fuel economy by shifting to the next higher gear. The vehicle will not be harmed if the transaxle is not shifted when the light comes on, but the vehicle will use more fuel.

The shift indicator light can be ignored when you are downshifting, on steep hills, using the engine to "brake" the vehicle, or need more power for a difficult acceleration.

Downshifting

When you slow down or climb a steep hill, always downshift before the engine starts to lose power. Downshifting reduces the chance of stalling and gives your vehicle better acceleration to increase speed again.

When you drive down steep hills, downshifting helps you keep a safe speed and helps prevent unnecessary wear on the brakes.

Do not attempt to shift into 1 (First) gear with the clutch pedal depressed at speeds higher than 10 mph (16 km/h). If you do, it could cause a complete clutch failure, making your vehicle inoperative.

Steering Your Vehicle

Your vehicle may be equipped with power steering. Power steering uses energy from the engine to help steer your vehicle.

If the amount of effort needed to steer your vehicle changes at a constant vehicle speed, have the power steering system checked. If the power steering system breaks down (or if the engine is turned off), you can steer the vehicle manually but it takes more effort.

Never hold the steering wheel to the extreme right or left for more than five seconds if the engine is running. This can damage the power steering pump.

Brakes

Applying the Brakes

Your vehicle has power-assisted brakes that adjust automatically as the brake pads or linings wear down.

Your vehicle may have four-wheel anti-lock disc brakes which adjust automatically through everyday use. Refer to section on anti-lock brakes later in this chapter.

Apply the brake pedal gradually. Use the "squeeze" technique — push on the brake pedal with a steadily increasing force. This allows the wheels to continue to roll while you are slowing down, which lets you steer properly.

If your vehicle does not have anti-lock brakes, extreme braking can make the wheels lock and slide, causing you to lose control of the steering. If the wheels lock, release the brake pedal and repeat the "squeeze" technique.

Do not drive with your foot resting on the brake pedal; you will wear out the linings and increase your vehicle's stopping distance. Brake rotor damage may also eventually occur.

 **WARNING**

If you are driving down a long or steep hill, shift to a lower gear. Do not apply your brakes continuously, as they may overheat and become less effective.

Occasional brake squeal during light to moderate stops does not affect the function of the brake system and is normal. However, if the squeal becomes annoyingly loud or increases significantly in frequency of occurrence, return the vehicle to your dealer for inspection.

The high-mount brakelamp will light when you apply the brakes.

Anti-lock Brake System (If equipped)

Your vehicle may come with the optional anti-lock brake system. Whenever your wheels start to lock (which could result in a skid) the anti-lock brake system prevents the lock-up by automatically releasing and re-applying the brakes. The brake pedal will pulsate as a result of the automatic releasing and re-applying of the brakes. In spite of this improvement in braking performance, you should continue to be cautious in all hazardous driving situations, especially when driving on hazardous road surfaces. Even

with your anti-lock brake system, you may not have total control of your vehicle when braking on roads with loose surfaces such as snow or gravel, holes in the pavement, or alternating patches of slippery and dry surfaces.

Each time you turn the ignition key to the ON position, the anti-lock brake system will function through one test cycle. When this happens, the anti-lock light (ABS) will come on for up to six seconds. If the light stays on longer than six seconds, shut off the engine and restart. If it remains on, it means the anti-lock brake system is disabled and should be serviced immediately to restore the benefits of the anti-lock feature. Normal braking is not affected unless the red brake warning light is also lit.

The anti-lock brake system has self-check capabilities. As described above, the system turns on the anti-lock light each time you start your engine. After the engine is started and the anti-lock light turns off, the system performs another test the first time the vehicle reaches 7 mph (11 km/h). The system turns on the ABS pump motor for approximately 1/2 second. At this time, a mechanical noise may be heard. This is a normal part of the self-check feature. If a malfunction is found during this check the anti-lock light will come on.

Ford Motor Company has not found any negative effects of mobile radio transmitting equipment installed on vehicles with the ABS system providing that the radio is installed according to the radio manufacturer's instructions. However, if you have had a mobile radio transmitter installed and the ABS light comes on (at any time other than immediately

after turning the key to the ON position) have your mobile radio dealer inspect the radio installation. Also, if the ABS system is activated other than during maximum braking, have your mobile radio installation checked.

Parking Brake

The parking brake should be used whenever you park your vehicle.

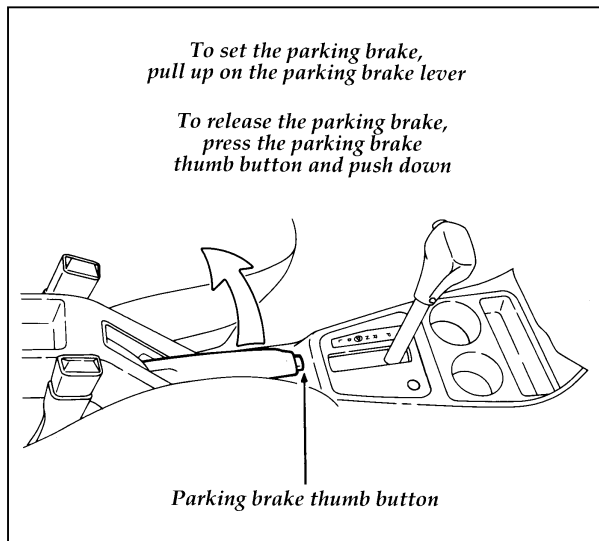

The parking brake lever (automatic transaxle shown)

The parking brake lever is located between the front seats. To set the parking brake, put your foot on the brake pedal while pulling the parking brake handle fully and firmly upward.

To release the parking brake, put your foot on the brake pedal, pull the handle upward and push the button. Then lower the handle to the released position while holding the button in.

⚠ WARNING

Always set the parking brake fully and make sure that the gearshift is securely latched in P (Park) (automatic transaxle) or in 1 (First) (manual transaxle).

⚠ WARNING

Never leave your vehicle unattended while it is running.

Always check the Brake Warning Light each time you start your engine. Driving with the parking brake on will cause the brakes to wear out quickly and will reduce the fuel economy.

⚠ WARNING

If the parking brake is fully released, but the Brake System light remains on, have the brakes checked immediately. They may not be working properly.

⚠ WARNING

To prevent personal injury, do not release the parking brake while outside the vehicle.

The parking brake is not designed to stop a moving vehicle, but you can use the parking brake to stop your vehicle in an emergency if the normal brakes fail. However, since the parking brake applies only the rear brakes, the stopping distance will increase greatly and the handling of your vehicle will be adversely affected.

Driving Under Special Conditions

Tips for Safe Driving

As with any new vehicle, yours may drive and handle differently from your previous vehicle. Use care until you become accustomed to its various features and driving characteristics.

Operate your vehicle within reasonable limits. Sudden acceleration, deceleration, turning, or combinations of these maneuvers can cause a vehicle to behave differently than anticipated.

- Extreme acceleration can cause the front wheels to spin, perhaps resulting in reduced steering control.
- If you do not have anti-lock brakes, extreme braking can cause wheels to lock and slide, making it difficult to control the direction of the vehicle. Use the "squeeze" technique by pushing on the brake pedal with steadily increasing force. This allows the wheels to brake yet continue to roll so that you may steer in the direction you want to travel. If you lock the wheels, release the brake pedal and repeat the squeeze technique.
- If you abruptly release the accelerator or brake hard while going too fast around a severe curve, your vehicle may change direction. Avoid application of the brakes, if possible. If braking is necessary, it should be done by using the "squeeze" technique described above.

Driving in Bad Weather

Slippery roads

On some slippery road surfaces, front-wheel drive may provide better acceleration than rear-wheel drive. However, this does not mean that your vehicle can stop any faster or any better than a vehicle with rear-wheel drive. Exercise the same caution while driving on slippery roads with your front-wheel drive vehicle as you would with a rear-wheel drive vehicle.

Drive cautiously on wet or snowy roads:

- Do not quickly move the steering wheel unless necessary.
- Drive slower than you normally would.
- Give your vehicle more distance to stop.
- Pump the brake pedal steadily and evenly to avoid locking your wheels. (Does not apply to vehicles with anti-lock brakes.)
- Consider using one of the lower gears.

 WARNING
To avoid losing control on slippery roads, do not downshift into 1 (First) with the automatic transaxle when moving faster than 20 mph (32 km/h). Do not downshift into 1 (First) with the manual transaxle when moving faster than 10 mph (16 km/h).

⚠️ WARNING

If your vehicle has speed control, do not use it on slippery roads. You could lose control of your vehicle and could injure someone.

If you have an automatic transaxle and your vehicle gets stuck (for example, in mud or snow), you may try to "rock" it out of the spot. Shift, in a steady rhythm, between forward and reverse gears. While in each gear, press lightly on the accelerator and release.

⚠️ WARNING

Do not spin the wheels at over 35 mph (55 km/h). The tires may fail and injure a passenger or bystander.

By moving the vehicle backward and forward, you may gain enough momentum to move out of the spot. Do not rock the vehicle for more than a few minutes. This may overheat the engine, damage the transaxle, or damage the tires. If you are still stuck after a minute or two of rocking, call for a tow truck.

High water

Do not drive through flooded areas unless you are sure that the water is below the bottom of the wheel rims.

If you must drive through high water, drive slowly. You may have limited traction or wet brakes, so allow extra stopping distance because your vehicle will not stop as quickly as usual.

After you drive through the standing water, apply your brakes gently several times as your vehicle moves slowly. This helps to dry the brakes.

Driving With a Heavy Load

There are limits to the amount of weight your vehicle can carry. The total weight of your vehicle, plus the weight of the passengers and cargo, should never be more than the Gross Vehicle Weight Rating (GVWR). Also, the weight that your vehicle carries over the front axle and rear axle should never be more than the Gross Axle Weight Rating (GAWR) for the respective axle.

You can find your vehicle's GVWR and GAWR on the Safety Compliance Certification Label on the left front door lock facing or on the door latch post pillar.

Usage of replacement tires with a higher weight limit than originals does not increase GVWR or GAWR. Usage of lower capacity replacement tires may lower GVWR and GAWR limitations and is not recommended.

 WARNING
--

<p>If the GVWR or the GAWR specified on the Safety Compliance Certification Label is exceeded, your vehicle may be damaged or you may lose control and injure someone.</p>

Towing Behind Another Vehicle — Recreational Vehicle

Towing an automatic transaxle vehicle behind another vehicle, such as a Recreational Vehicle (RV), is not recommended unless a front wheel dolly is used. Do not tow your automatic transaxle with the front wheels on the ground or transaxle damage may occur.

Towing a manual transaxle vehicle behind another vehicle, such as a Recreational Vehicle (RV), is allowed only if towed in a forward direction with the front wheels on the ground. This is the only way to tow behind an RV with the wheels on the ground without damage to the transaxle.

When towing a vehicle with a manual transaxle without a front wheel dolly, the gear selector should be in neutral.

⚠ WARNING

Never use a tow bar that attaches to the bumper when you tow your vehicle. This could damage the bumper and cause an accident.

Trailer Towing

We do not advise using your vehicle for towing a trailer.

Limiting Your Vehicle's Load

The load that you add to your vehicle must not exceed the maximum load stated on the tire information decal attached to the face of the right rear door pillar.

To figure the weight of your vehicle's load, add the weights of:

- the driver and passengers
- luggage and any other items that you put in your vehicle
- the weight of any equipment that has been added to your vehicle since it was delivered to your dealer

If you do not know the actual weights of these items, use the following procedure to figure the weight of a load:

1. Weigh your vehicle without the driver, passengers, and luggage. You might take your vehicle to a shipping company or an inspection station for trucks.
2. Then weigh your vehicle with the driver, passengers, and luggage.
3. Subtract the first reading from the second to figure the total weight of the load.

After determining this load, you must also make sure that the total weight of your vehicle, plus the load it carries, is less than its GVWR. Also, make sure that the weight your vehicle carries over each axle is less than the GAWR for the respective axle.

If your vehicle exceeds the GVWR, remove cargo from your vehicle accordingly. If your vehicle exceeds either GAWR, shift the load or remove cargo accordingly.

⚠ WARNING

Improper distribution of your vehicle's load or carrying weight in excess of the amount shown on the tire decal can cause rapid tire wear or loss of vehicle control.

⚠ WARNING

If the GVWR or the GAWR specified on the Safety Compliance Certification Label is exceeded, your vehicle may be damaged or you may lose control and injure someone.

Roadside Emergencies

Jump-Starting Your Vehicle

Your vehicle's battery may die if you leave the lights or any electrical equipment on after you turn the engine off. If this happens, you may be able to jump-start from a booster battery to start your vehicle.

⚠️ WARNING

The gases around the battery can explode if exposed to flames, sparks, or lit cigarettes. An explosion could result in injury or vehicle damage.

⚠️ WARNING

To protect yourself when charging a battery, always shield your face and eyes. Make sure that you can breathe fresh air.

⚠️ WARNING

Applying too much pressure on the ends when lifting a battery could cause acid to spill. Lift the battery with a carrier or with your hands on the opposite corners.

⚠️ WARNING

Batteries contain sulfuric acid which burns skin, eyes, and clothing.

If the acid touches someone's skin, eyes, or clothing, immediately flush the area with water for at least 15 minutes. If someone swallows the acid, have him or her drink lots of milk or water first, then Milk of Magnesia, a beaten egg, or vegetable oil. Call a doctor immediately.

 **WARNING**

To avoid damage or injury, follow these directions in the order they are given. If in doubt, call for road service.

Preparing Your Vehicle

1. Your vehicle has a 12-volt starting system, so you need to use a 12-volt jumper system. You will damage your starting motor, ignition system, and other electrical parts if you connect them to a 24-volt power supply (either two 12-volt batteries in series or a 24-volt generator set).
2. Do not disconnect the battery of the disabled vehicle. You could damage the vehicle's electrical system.
3. Park the booster vehicle close to the hood of the disabled vehicle. **Make sure the vehicles do not touch each other.** Set the parking brake on both vehicles and stay clear of the engine cooling fan and other moving parts.
4. Check all battery terminals and remove any excessive corrosion before you attach the jumper cables.
5. Turn on the heater fan in both vehicles. Turning on the fan helps protect the electrical system from voltage surges. Turn off all other switches and lights in both vehicles to prevent possible damage to either vehicle's electrical systems.

Connecting the jumper cables

1. Connect one end of the first jumper cable to the positive (+) terminal of the discharged battery. (You can connect either jumper cable to the positive (+) terminal, as long as you use the same cable for both positive terminals.) Most jumper cables have a red cable and a black cable. The red cable is generally used for the positive terminals and the black for the negative ones.
2. Connect the other end of the first cable to the positive (+) terminal of the booster battery.
3. Connect one end of the second cable to the negative (–) terminal of the booster battery — NOT to the discharged battery.
4. Connect the other end of the second cable to a good metallic surface on the engine or frame of the disabled vehicle.

 WARNING
--

<p>Do not connect the end of the second cable to the negative (–) terminal of the battery to be jumped. A spark may cause an explosion of the gases that surround the battery.</p>

*Make sure vehicles
do not touch*

*Make connections in numerical order
(disconnect in reverse order 4, 3, 2, 1)*

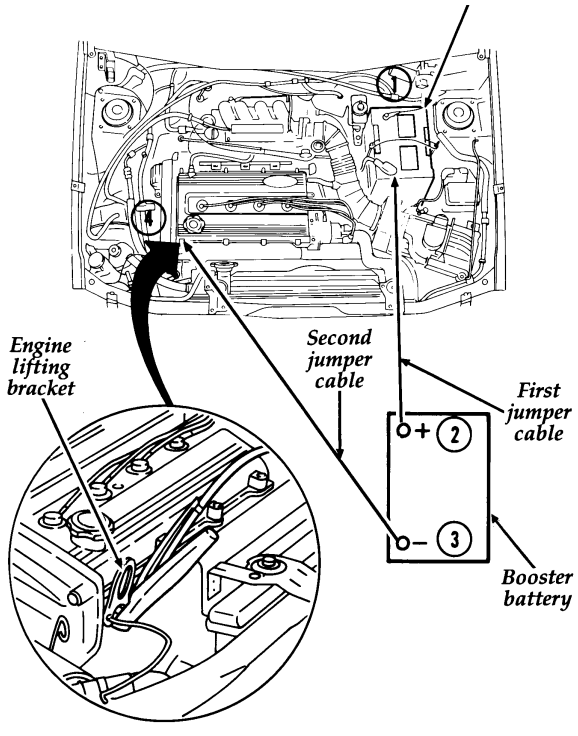

The battery with jumper cables (1.8L engine)

**Make sure vehicles
do not touch**

**Make connections in numerical order
(disconnect in reverse order 4, 3, 2, 1)**

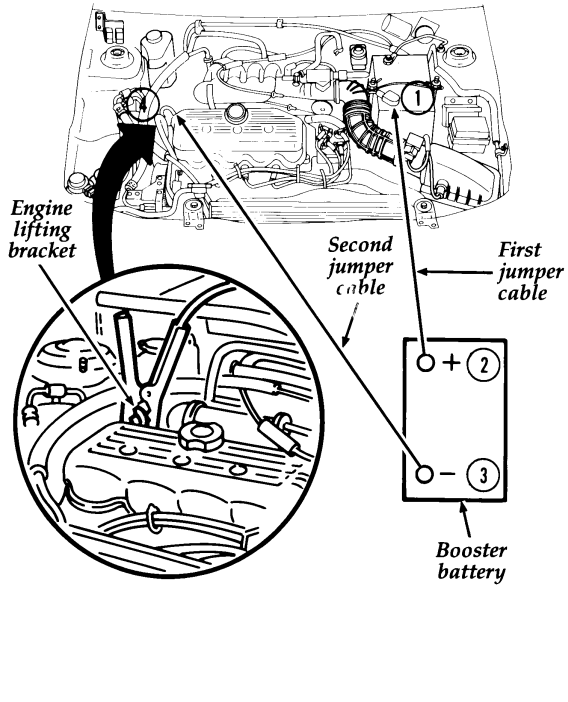

The battery with jumper cables (1.9L engine)

Jump-Starting

1. Make sure that the jumper cables are not in the way of moving engine parts, then start the booster vehicle. Run the engine at a moderate speed.
2. Let the discharged battery charge for a few minutes and then start the disabled vehicle. It may take a couple of tries before the vehicle starts. If the vehicle does not start after several attempts, there may be a different problem.
3. When both vehicles are running, let them idle for a few minutes to charge the discharged battery.

Removing jumper cables

1. **Always remove the jumper cables in the reverse order.** Remove the negative (–) end of the jumper cable from the metallic surface on the engine or frame of the disabled vehicle.
2. Remove the negative (–) cable from the booster battery.
3. Remove the positive (+) cable from the booster battery.
4. Remove the other end of the positive (+) cable from the discharged battery.

After the vehicle is started, let it idle for a while to let the engine “relearn” its idle conditions. Drive it around for a while with all electrical accessories turned off to let the battery recharge. **You may need to use a battery charger to fully recharge the battery.**

If you need to replace your battery, see *Battery* in the *Servicing Your Vehicle* chapter.

Changing a Tire

If you get a flat tire while you are driving, do not apply the brake heavily. Instead, gradually decrease the speed. Hold the steering wheel firmly and slowly move to a safe place on the side of the road. Park on a level spot, turn off the ignition, set the parking brake, and turn on the hazard flashers.

The Temporary Spare Tire

You may have a high pressure temporary spare tire. This spare tire is smaller than a regular tire and is designed for emergency use only. Use it only when you get a flat tire and replace it as soon as you can. This spare tire is marked with the words "TEMPORARY USE ONLY" so that you can easily identify it.

⚠ WARNING

If you use the temporary spare tire continuously or do not follow these precautions, the tire could fail, causing you to lose control of the vehicle, possibly injuring yourself or others.
--

When you drive with the temporary spare tire, DO NOT:

- exceed 50 mph (80 km/h) under any circumstances.
- load your vehicle so that it is heavier than the maximum vehicle load rating listed on the tire decal.
- use tire chains on this tire.

- try to repair the temporary spare tire or remove it from its wheel.
- use the wheel for any other type of vehicle.
- drive through an automatic car wash with this tire. Because the temporary spare tire is smaller than a conventional tire, it reduces the ground clearance. Your vehicle may get caught in the rails and it could be damaged.

Spare Tire Location

The spare tire is stored under the carpet and board in the luggage compartment.

You will find additional instructions for the spare tire on the wheel decal (located on the spare tire). The jack is stored on the right side of the trunk under the floor panel. Lift up the floor panel for access to the spare tire.

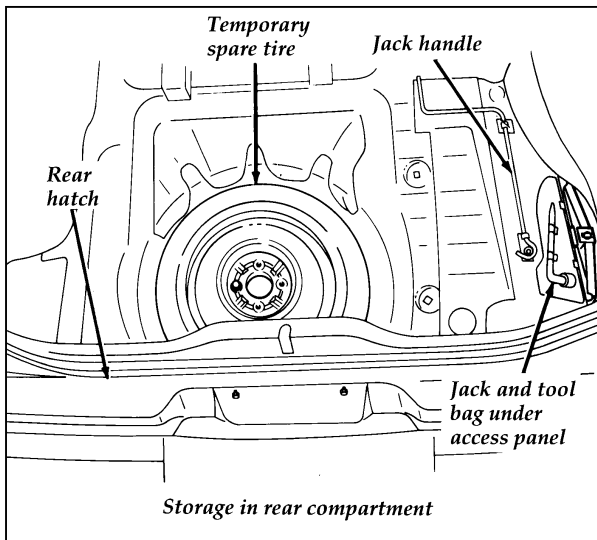

The location of the spare tire

Preparing to Change the Tire

1. Make sure that your vehicle will not move or roll. If you have an automatic transaxle, put the gearshift in P (Park). If you have a manual transaxle, put the gearshift in 1 (First). Set the parking brake and block the wheel that is diagonally opposite the tire that you are changing.

When one of the front wheels is off the ground, the transaxle alone will not prevent the vehicle from moving or slipping off the jack, even if the vehicle is in P (Automatic) or 1 (Manual). To prevent the vehicle from moving when you change one of the front tires, put a block behind the wheel that is diagonally opposite the tire.

 WARNING
--

If the vehicle slips off the jack, you or someone else could be seriously injured.

2. Get out the spare tire and jack.
3. Remove any optional wheel covers or center caps covering the lug nuts by gently prying with the tapered end of the lug wrench.
4. Loosen the wheel lug nuts one-half turn each, but do not remove them until the tire is raised off the ground. You should pull up on the handle rather than push to develop maximum force to loosen wheel lug nuts.

Removing and Replacing the Tire

1. Place the scissors-type jack under the side of the vehicle and adjust the jack height with the jack handle. The jack should fit under the side sill. There are small notches in the seam to indicate the proper position for the jack.

⚠ WARNING

To lessen the risk of personal injury, do not put any part of your body under the vehicle while changing a tire. Do not start the engine when your vehicle is on the jack. The jack is only meant for changing the tire.

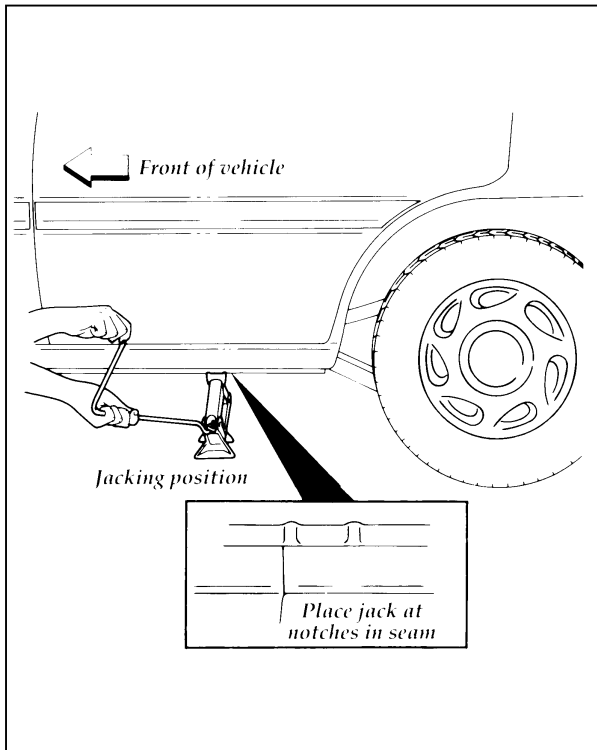

The location for the jack (left rear trim panel shown)

2. Insert the jack handle into the jack and turn it clockwise until the tire just clears the ground. Remove the wheel lug nuts.

Your vehicle has metric (12 mm) wheel studs and lug nuts. During wheel removal and replacement, make certain that you use the same lug nuts to reinstall the wheel or replace them with nuts of the same metric size and threading.

 **WARNING**

Installation of an English thread nut on a metric stud (or vice-versa) will not properly secure the wheel to the hub. Damaged studs may result in wheel separation and possible injury.

3. Replace the flat tire with the spare tire.
(*TEMP. USE ONLY* label facing outward.)
4. Reinstall the lug nuts, tightening until the wheel is snug against the hub. The beveled edges on the lug nuts face inward. Do not fully tighten the lug nuts until you lower the vehicle. If you do, you could force the vehicle off the jack.
5. Lower the vehicle by turning the jack handle counterclockwise.

6. Remove the jack and fully tighten the lug nuts in the order shown in the following illustration.

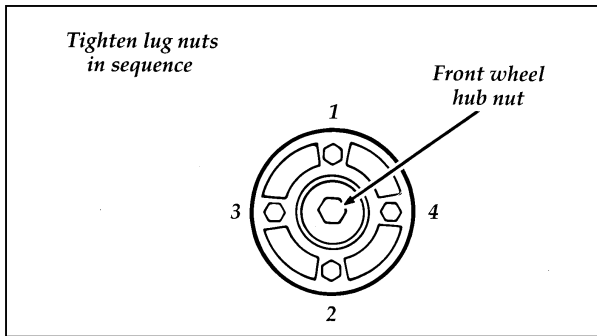

The lug nuts on the wheel

7. Replace any wheel covers, ornaments, or hub caps that your vehicle has. Line up the notch in the cover with the air valve on the tire and press on with the heel of your hand. (Some wheel covers have markings on the inside to point to the appropriate air valve notch.) Make sure that they are snapped into place.

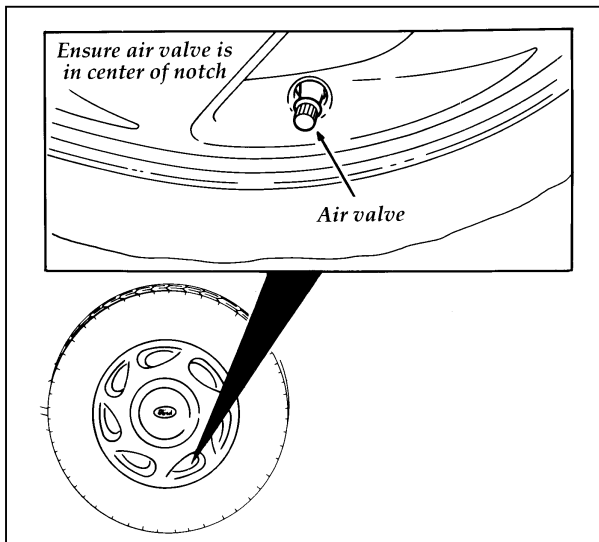

Replacing optional wheel covers

8. Put the tire, jack, and wrench away. Make sure the jack is securely fastened so it does not rattle when you drive.
9. Unblock the wheels.

Anti-Theft Wheel Lug Nuts (If equipped)

If your vehicle has “locking” lug nuts, one of the lug nuts on each wheel must be unlocked with a special key. The key and registration card are located in the tool bag with the lug wrench. If you lose the key, send the registration card to the manufacturer (not to the dealer) to get a replacement key.

NOTE: DO NOT USE A POWER IMPACT WRENCH ON THE LUG NUT KEY.

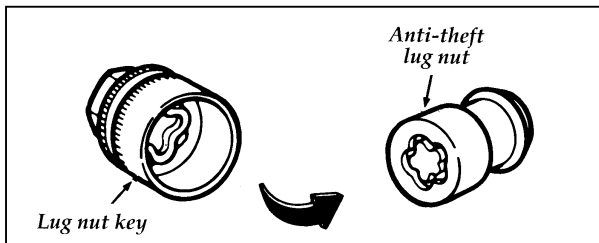

Anti-theft lug nut and key

Removing the anti-theft lug nut

Insert the key over the locking lug nut. Make sure that you hold the key square to the lug nut. If you hold the key on an angle, you may damage the key and the lug nut.

Place the lug nut wrench over the lug nut key and apply pressure on the key with the wrench. Turn the wrench in a counterclockwise direction to remove the lug nut.

Reinstalling the anti-theft lug nut

Insert the key over the locking lug nut. Place the lug nut wrench over the lug nut key and, while applying pressure on the key, install the lug nut.

If the Engine Cranks but Does Not Start or Starting After a Collision

The Fuel Pump Shut-off Switch

If the engine cranks but does not start or if you have had a collision, the fuel pump shut-off switch may have been triggered. The shut-off switch is a device that stops the fuel pump when your vehicle has been involved in a substantial jolt.

For information on how to check and reset the fuel pump shut-off switch, see *Fuel pump shut-off switch* in the Index.

Towing Your Vehicle

DO NOT TOW WITH SLINGBELT EQUIPMENT. Ford Motor Company has not developed or approved a T-hook or slingbelt towing procedure. It is recommended that your vehicle be towed with wheel lift or flatbed equipment.

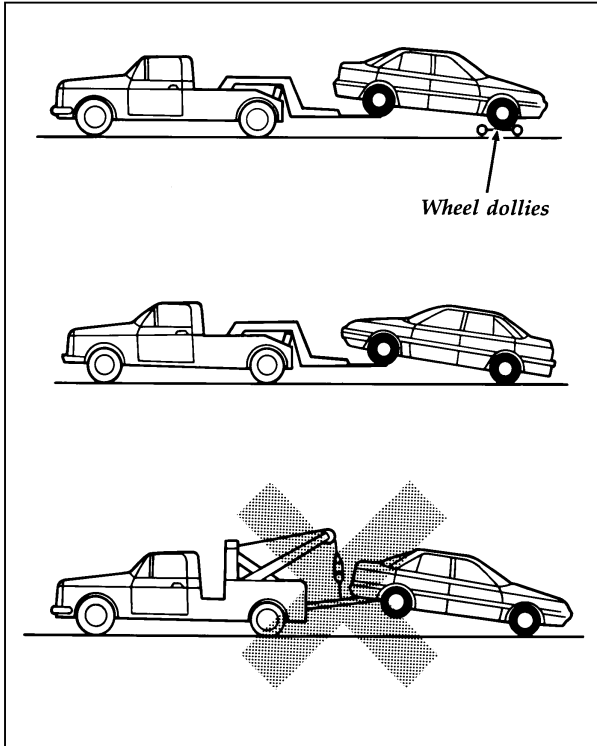

Towing your vehicle

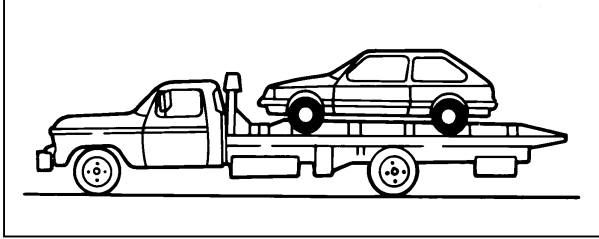

Towing your vehicle on a flatbed truck

Customer Assistance

Roadside Assistance

Ford Motor Company has set up a 24-hour, seven-day-a-week hotline with trained operators who put you in touch with the help you need if you experience a problem with your vehicle. This complimentary service is provided to you throughout your warranty period of 3 years or 36,000 miles (60,000 km), whichever comes first. To purchase Roadside Assistance coverages beyond this period (available through Ford Auto Club in the United States or Ford and Lincoln-Mercury dealers in Canada), contact your Ford or Lincoln-Mercury dealer.

Roadside Assistance will cover the following:

- Mount your spare if you have a flat tire.
- Jump-start your battery if it is dead.
- Unlock your vehicle if you are locked out.
- Bring you fuel if you run out.
- Tow your vehicle if you are stranded. Even non-warranty related tows, like accidents or getting stuck in mud or snow, are covered (some exclusions apply, such as impound towing and repossession).

How to use Roadside Assistance

Your Roadside Assistance identification card can be found in the Owner Guide portfolio in your glove compartment. Complete the card and place it in your wallet for quick reference.

To receive roadside assistance in the United States call 1-800-241-FORD (in Canada call 1-800-665-2006).

Should you need to arrange for roadside assistance yourself, Ford Motor Company will reimburse the reasonable cost. To obtain information about reimbursement call 1-800-241-FORD (in Canada call 1-800-665-2006).

If You Have a Service Problem

Ford Motor Company has authorized Ford and Lincoln-Mercury dealerships that can service your vehicle for you. This chapter tells you how to get service or maintenance for your vehicle.

Service/Maintenance Concerns (U.S. or Canada)

Ford recommends taking your vehicle to your selling dealer who wants to ensure your continued satisfaction. You may, however, take your vehicle to any authorized Ford or Lincoln-Mercury dealer. In most cases, your dealer will be able to resolve your concern.

If you are not satisfied with the service you received from your dealership's service department, talk to the service manager at the dealership, or if you still are not satisfied, talk to the owner or general manager of the dealership. In most cases, you will have your concern resolved at this level.

If you are away from home when your vehicle needs to be serviced, or if you need more help than the dealer gave you, contact the Ford Customer Assistance Center to find an authorized dealership that may be able to help.

To process your request, the Ford Customer Assistance Center needs the following information:

- your telephone number (both business and home)
- the name of the dealer and the city where the dealership is located
- the year and make of your vehicle
- the date purchased
- the current mileage on your vehicle
- your Vehicle Identification Number (VIN) (listed on your owner card)

If you have questions or concerns with your vehicle, please follow these steps:

1. Contact your Sales Representative or Service Advisor at your selling/servicing dealership.
2. If the inquiry or concern remains unresolved, contact the Sales Manager or Service Manager at your selling/servicing dealership.
3. If the inquiry or concern cannot be resolved at the dealership level, contact the Ford Customer Assistance Center.

In the United States, contact:

*Ford Motor Company
Customer Assistance Center
300 Renaissance Center
P.O. Box 43360
Detroit, Michigan 48243
1-800-392-3673 (FORD)
TDD for the hearing impaired: 1-800-232-5952*

If you live in Canada and have any questions or concerns that the dealership cannot answer, contact the Customer Assistance Centre.

*Customer Assistance Centre
Ford Motor Company of Canada, Limited
P.O. Box 2000
Oakville, Ontario L6J 5E4
1-800-565-3673 (FORD)*

If you still have a service or product complaint, you may wish to contact the Dispute Settlement Board (U.S. only) or the Canadian Motor Vehicle Arbitration Plan (CAMVAP) in Canada.

The Dispute Settlement Board (U.S. only)

The Dispute Settlement Board is a voluntary, independent dispute-settlement program available free to owners or lessees of qualifying Ford Motor Company vehicles.

The Dispute Settlement Board may not be available in all states. Ford Motor Company reserves the right to change eligibility limitations, modify procedures and/or to discontinue this process at any time without notice and without incurring obligations.

What Kind of Cases Does the Board Review?

The Board reviews unresolved warranty performance complaints on Ford, Mercury and Lincoln cars and Ford and Mercury Light Trucks under warranty that have not been resolved by a dealer or Ford Motor Company.

The Board does not review issues involving:

- A non-Ford product
- A non-Ford dealership
- A vehicle sales transaction
- A request for reimbursement of consequential expenses unless incidental to a service or product complaint being reviewed
- Items not covered by your warranty
- Alleged liability claims
- Property damage where such damage is significant when compared to the economic loss alleged under the warranty dispute
- Cases currently in litigation
- Vehicles not used primarily for personal, family, or household purposes

NOTE: Complaints involving vehicles on which applicable express written new vehicle warranties have expired at receipt of your application are not eligible. Eligibility may differ according to state law. For example, see the unique brochure for California purchasers/lessees.

How Does the Board Work?

The Board has four members:

- three consumer representatives
- a Ford or Lincoln-Mercury dealer

Consumer candidates for Board membership are recruited and trained by an independent consulting firm. Dealers are chosen because of their business leadership qualities.

If the involved vehicle is within 36 months and 36,000 miles of the date of delivery (warranty start date), you have a right to make an oral presentation before the Board by indicating your choice on the application. Also, oral presentations may be requested by the Board. A decision is made by the Board by simple majority vote.

Board members review all the materials related to each complaint and, based on the available information, arrive at a fair and impartial decision. Decisions are based on the written statements and any oral presentations made by each of the involved parties.

Because the Board usually meets only once a month, some cases will take longer than 30 days to be reviewed. The Board will make every effort to resolve each case within 40 days after it receives the customer application form.

After your case has been reviewed, the Board will mail you its decision in writing. It will also provide you with a form to indicate your acceptance or rejection of an award decision. The decisions of the Board are binding on the dealer and Ford, but customers may have other options available to them under state or federal law.

The decisions of the Board, however, may be introduced into evidence by any party in subsequent legal proceedings that may be initiated.

How Do You Contact the Board?

Write to the Board to request a brochure/application:

<p style="text-align: center;"><i>Dispute Settlement Board P.O. Box 5120 Southfield, MI 48086-5120</i></p>
--

You will be sent a brochure and a one-page customer application form. To begin the Board review process, the form should be completed and mailed to the special Board P.O. Box number shown above.

What is the Review Process?

Your application will be reviewed and if it is determined to be eligible, you will receive an acknowledgment indicating the file number assigned to your application and the local Board address. At the same time, your dealer and Ford Motor Company representative are asked to submit statements.

To review your case properly, the Board needs the following information:

- legible copies of all documents and maintenance or repair orders that relate to the case
- the year, make, model, and vehicle identification number (VIN)

- the date you bought your vehicle
- the date of repair and the mileage at the time of repair
- the current mileage
- the name of the dealer who sold you the vehicle or who serviced your vehicle
- a brief description of your unresolved complaint
- a brief summary of actions that were taken with the dealer and Ford Motor Company
- the names (if known) of all people you contacted at the dealership
- a description of the action you want done to resolve your concern.

Should your application NOT qualify for review, an explanation will be mailed to you.

Reporting Safety Defects (U.S. only)

If you believe that your vehicle has a defect which could cause a crash or could cause injury or death, you should immediately inform the National Highway Traffic Safety Administration (NHTSA) in addition to notifying Ford Motor Company.

If NHTSA receives similar complaints, it may open an investigation, and if it finds that a safety defect exists in a group of vehicles, it may order a recall and remedy campaign. However, NHTSA cannot become involved in individual problems between you, your dealer, or Ford Motor Company.

To contact NHTSA, you may either call the Auto Safety Hotline toll-free at 1-800-424-9393 (or 366-0123 in the Washington, D.C. area) or write to: NHTSA, U.S. Department of Transportation, 400 Seventh Street, Washington D.C. 20590. You can also obtain other information about motor vehicle safety from the Hotline.

Ford of Canada Customer Assistance

If you live in Canada and have any questions or concerns that the dealership cannot answer, contact the Customer Assistance Centre.

*Customer Assistance Centre
Ford Motor Company of Canada, Limited
P.O. Box 2000
Oakville, Ontario L6J 5E4
1-800-565-3673 (FORD)*

Please have the following information available when contacting the Lincoln Centre:

- your telephone number (both business and home)
- your Vehicle Identification Number (VIN) listed on your owner card and/or your vehicle ownership license
- the year and make of your vehicle
- the date purchased
- the name of the dealer and the city where the dealership is located
- the current mileage on your vehicle

Canadian Motor Vehicle Arbitration Plan (CAMVAP)

If a specific item of concern arises, where a solution cannot be reached between a vehicle owner, Ford of Canada, and/or one of its dealers (that all parties can agree upon), the owner may wish to use the services offered by the Canadian Motor Vehicle Arbitration Plan (CAMVAP).

CAMVAP uses the services of Provincial Administrators to assist consumers in scheduling and preparing for their arbitration hearings. However, before you can proceed with CAMVAP you must follow your manufacturer's dispute resolution process as outlined under *Service/Maintenance Concerns (U.S. or Canada)* earlier in this chapter.

Consumers wishing to obtain further information about the program can obtain an information booklet from your dealer or contact the Provincial Administrator, Canadian Motor Vehicle Arbitration Plan, at the address or telephone number shown below.

O & P Services
595 Bay Street — Suite 300
Toronto, Ontario
M5G 2C2
Telephone 1 (800) 207-0685

This plan is not available in the province of Quebec.

Getting Help Outside the U.S. and Canada

Before you export your vehicle to a foreign country, contact the appropriate foreign embassy or consulate to make sure local regulations do not prevent you from registering your vehicle. Officials at the embassy can also help you decide whether you should import your vehicle to that country.

Officials at the embassy or consulate can tell you where to get unleaded fuel. If you cannot get unleaded fuel or can get only fuel with an anti-knock index that is lower than your vehicle needs, contact a district or owner relations office before you leave the U.S. or Canada.

Use of leaded fuel in your vehicle without a proper conversion may damage the effectiveness of your emissions control system and may cause engine knocking or serious engine damage. Ford Motor Company is not responsible for any damage that is caused by use of improper fuel.

You may also have difficulty importing your vehicle back into the U.S. if you use leaded fuel.

If your vehicle must be serviced while you are traveling or living in Central or South America, the Caribbean, or the Middle East, contact the nearest Ford dealership. If the dealership cannot help you, write to:

*FORD MOTOR COMPANY
WORLDWIDE EXPORT OPERATIONS
1555 Fairlane Drive
Fairlane Business Park #3
Allen Park, Michigan 48101 U.S.A.
Telephone: (313) 594-4857
Fax: (313) 390-0804*

If you are in other foreign countries, contact the nearest Ford dealership. If the dealership cannot help you, they can direct you to the appropriate Ford affiliate office.

If you buy your vehicle in North America and then relocate outside of the U.S. or Canada, register your Vehicle Identification Number and new address with Ford Motor Company Export Operations.

Accessories

Ford Accessories for Your Vehicle

Ford has many fine products available from your dealer to clean your vehicle and protect its finishes. For best results, use the following, or products of equivalent quality.

- Ford Custom Clear Coat Polish
- Ford Custom Silicone Gloss Polish
- Ford Custom Vinyl Protectant
- Ford Deluxe Leather and Vinyl Cleaner
- Ford Extra Strength Spot and Stain Remover
- Ford Extra Strength Tar and Road Oil Remover
- Ford Extra Strength Upholstery Cleaner
- Ford Extra Strength Whitewall Tire Cleaner
- Ford Multi-Purpose Cleaner
- Ford Premium Car Wash Concentrate
- Ford Triple Clean
- Ford Ultra-Clear Spray Glass Cleaner

A wide selection of accessories is available through your local authorized dealer. These fine accessories have been engineered specifically to fulfill your automotive needs. They are custom designed to complement the style and aerodynamic appearance of your Ford-built vehicle. In addition, each accessory is made from high quality materials and meets or exceeds Ford's rigid engineering and safety specifications. That is why Ford brand accessories are warranted for up to 3 years or 36,000 miles (60,000 km), whichever comes first. See your dealer for complete warranty information and accessory availability.

NOTE: Not all accessories are available for all vehicle models.

Safety, Comfort, and Convenience

Comfort and Convenience

Air conditioner
Cargo liner (soft)
Cargo net
Engine block heater

Travel Equipment

Console
Door edge guards
Four seasons base rack
Four seasons rack adaptors

- Bike adaptor
- Ski adaptor (3 pair)

Heavy-duty battery
Multi-sport removable rack
Multi-sport rack adaptors

- Bike adaptor
- Ski/snowboard adaptor (4 pair)
- Ski/snowboard adaptor (6 pair)
- Water sport adaptor

Speed control
Trunk-mount luggage rack
Soft luggage cover

Protection and appearance equipment

Carpet floor mats
Flat splash guards
Molded splash guards
Styled wheel protector locks
Side window air deflectors
Cleaners, waxes and polishes
Front end covers
Lubricants and oils
Mini mask
Remote keyless entry
Super Seal Rustproofing (Not available in Canada)
Super Seal Fabric Protector (Not available in Canada)
Super Seal Undercoating (Not available in Canada)
Touch-up paint
Vehicle security system

NOTE: When adding accessories, equipment, passengers, and luggage to your vehicle, do not exceed the total weight capacity of the vehicle or of the front or rear axle (GVWR, GAWR as shown on the Safety Compliance Certification Label). Consult your dealer for specific weight information.

NOTE: The Federal Communications Commission (FCC) or the Canadian Radio Telecommunications Commission (CRTC) regulates the use of mobile communications systems — such as two-way radios, telephones, and theft alarms — that are equipped with radio transmitters. Any such equipment installed in your vehicle should comply with FCC or CRTC regulations and should be installed only by a qualified technician.

NOTE: Mobile communications systems may harm the operation of your vehicle, particularly if they are not properly designed for automotive use or are not properly installed. For example, when operated, such systems may cause the engine to stumble or stall. In addition, such systems may themselves be damaged or their operation affected by operating your vehicle. (Citizens band [CB] transceivers, garage door openers, and other transmitters whose power output is 5 watts or less will not ordinarily affect your vehicle's operation.)

NOTE: Because we have no control over the installation, design, or manufacture of such systems, Ford cannot assume responsibility for any adverse effects or damage that may result if you use this equipment.

1996 Escort Owner Manual Order Form

PUBLICATION FORM NO.	DESCRIPTION
FCS-12082-96	1996 Escort Service Manual
FCS-12106-96	1996 Powertrain Control/ Emission Diagnosis
FCS-12139-96	1996 Car Service Spec. (FWD/RWD)
FCS-12117-96	1996 Escort Electrical & Vacuum Troubleshooting Manual
93-VID-OM	Ford and the American Dream (50) Minutes of Historic/Nostalgic Videotape

- **NOTE:** For publications prior to year shown above, write for availability to the address shown below.
- Please allow ample time for postal service delivery.

U.S. RESIDENTS

Make checks payable to: HELM, INCORPORATED

MAIL ORDER TO:

HELM, INCORPORATED
P.O. Box 07150
Detroit, Michigan 48207

OR ORDER TOLL FREE:

1-800-782-4356

Monday - Friday 8:00 A.M. - 6:00 P.M. EST
For Credit Card Holder Orders Only

CANADIAN RESIDENTS

Make-cheques payable to: Ford Motor Company of Canada, Ltd.

MAIL ORDER TO:

Ford Motor Company of Canada, Ltd.
Service Publications
P.O. Box 1580, Station B
Mississauga, Ontario, Canada L4Y 4G3

OR ORDER TOLL FREE:

1-800-387-4966

Monday - Friday 8:30 A.M. - 6:00 P.M. EST
For Credit Card Holder Orders Only

U.S. RESIDENTS USE THIS PAGE

<p>ORDER TOLL FREE 1-800-782-4356</p>	<p>NOTE: For Credit Card Holder Orders Only Monday-Friday 8:00 A.M.-6:00 P.M. EST</p>
<p><i>If further information is needed, write to the address shown below or call 1-800-782-4356. Material cannot be returned for credit without receiving advance authorization within 14 days of delivery. On returns, a re-stocking fee may be applied against the original order.</i></p>	

1 9 9 6	PUBLICATION FORM NUMBER	1996 ESCORT PUBLICATION	QTY.	PRICE EACH	TOTAL PRICE
		FCS-12082-96	Escort SM		\$ 84.00
	FCS-12106-96	Powertrain Control/ED		160.00	
	FCS-12139-96	Car Service Spec. (FWD/RWD)		32.00	
	FCS-12117-96	Escort EVTM		30.00	
	93-VID-OM	Videotape		19.95	

P A Y M E N T	<input type="checkbox"/> Check or Money Order payable to Helm, Inc. (USA funds only - do not send cash.)		<table border="1" style="width: 100%; border-collapse: collapse;"> <tr><td>TOTAL MATERIAL</td><td></td></tr> <tr><td>Michigan Purchasers add 6% sales tax</td><td></td></tr> <tr><td>Handling Charge</td><td align="right">\$4.00</td></tr> <tr><td>GRAND TOTAL</td><td></td></tr> </table>	TOTAL MATERIAL		Michigan Purchasers add 6% sales tax		Handling Charge	\$4.00	GRAND TOTAL	
	TOTAL MATERIAL										
	Michigan Purchasers add 6% sales tax										
	Handling Charge	\$4.00									
	GRAND TOTAL										
<input type="checkbox"/> MasterCard											
<input type="checkbox"/> VISA <input type="checkbox"/> Discover											
Account Number <input style="width: 20px;" type="text"/> <input style="width: 20px;" type="text"/> <input style="width: 20px;" type="text"/> <input style="width: 20px;" type="text"/> <input style="width: 20px;" type="text"/> <input style="width: 20px;" type="text"/> <input style="width: 20px;" type="text"/> <input style="width: 20px;" type="text"/> <input style="width: 20px;" type="text"/> <input style="width: 20px;" type="text"/> <input style="width: 20px;" type="text"/> <input style="width: 20px;" type="text"/> <input style="width: 20px;" type="text"/> <input style="width: 20px;" type="text"/> <input style="width: 20px;" type="text"/> <input style="width: 20px;" type="text"/> <input style="width: 20px;" type="text"/> <input style="width: 20px;" type="text"/> <input style="width: 20px;" type="text"/> <input style="width: 20px;" type="text"/>											
Expiration Date mo/yr: <input style="width: 20px;" type="text"/> <input style="width: 20px;" type="text"/> <input style="width: 20px;" type="text"/> <input style="width: 20px;" type="text"/>	<input type="checkbox"/> Check here if billing address is different from shipping address shown.										
(CUSTOMER SIGNATURE)		(DATE)									

S H I P T O	<p>NOTE: Dealers and Companies please provide dealer or company name, along with the name of the person to whom the shipment should be sent. For purchases outside U.S.A. and Canada, please write to the following address for quotation. Mail completed order form to: HELM, INC • P.O. Box 07150 • Detroit, MI 48207. Please allow 6-8 weeks for delivery. Prices are subject to change without notice and without incurring obligation.</p>	
	(CUSTOMER NAME)	(ATTENTION)
	(STREET ADDRESS - NO P.O. BOX NUMBERS)	(APT.NO.)
	(CITY)	(STATE) (ZIP CODE)
	DAYTIME TELEPHONE	AREA CODE () _____

CANADIAN RESIDENTS USE THIS PAGE

ORDER TOLL FREE
1-800-387-4966

NOTE: For Credit Card Holder Orders Only
 Monday-Friday
 8:30 A.M.-6:00 P.M. EST

If further information is needed, write to the address shown below or call 1-800-387-4966. Material cannot be returned for credit without receiving advance authorization within 14 days of delivery. On returns, a re-stocking fee may be applied against the original order.

1 9 9 6	PUBLICATION FORM NUMBER	1996 ESCORT PUBLICATION	QTY.	PRICE EACH	TOTAL PRICE
		FCS-12082-96	Service Manual		\$ 84.00
	FCS-12106-96	Powertrain Control/ED		160.00	
	FCS-12139-96	Light Truck Service Spec.		39.00	
	FCS-12117-96	Electrical & Vacuum T.M.		43.00	

PAYMENT	<input type="checkbox"/> Cheques or Money Order payable to Ford Motor Company of Canada, Ltd. (Do not send cash.)	<table border="1"> <tr><th>TOTAL MATERIAL</th><td></td></tr> <tr><th>G.S.T. (7%)</th><td></td></tr> <tr><td>Handling/Shipping Charge Individual Item Order Except Service Manuals \$5.00 OR Service Manuals and Multiple Item Orders \$10.00 (French Owner Guide: No Charge)</td><td></td></tr> <tr><th>GRAND TOTAL</th><td></td></tr> </table>	TOTAL MATERIAL		G.S.T. (7%)		Handling/Shipping Charge Individual Item Order Except Service Manuals \$5.00 OR Service Manuals and Multiple Item Orders \$10.00 (French Owner Guide: No Charge)		GRAND TOTAL	
	TOTAL MATERIAL									
	G.S.T. (7%)									
	Handling/Shipping Charge Individual Item Order Except Service Manuals \$5.00 OR Service Manuals and Multiple Item Orders \$10.00 (French Owner Guide: No Charge)									
GRAND TOTAL										
<input type="checkbox"/> VISA Only										

Account Number:

Expiration Date mo/yr: Check here if billing address is different from shipping address shown.

(CUSTOMER SIGNATURE) _____ (DATE) _____

SHIP TO

NOTE: Dealers and Companies please provide dealer or company name, along with the name of the person to whom the shipment should be sent. Mail completed order form to: Ford Motor Company of Canada, Ltd. • Service Publications • P.O. Box 1580, Station B Mississauga, Ontario, Canada L4Y 4G3. Please allow 6-8 weeks for delivery. Prices are subject to change without notice and without incurring obligation.

 (CUSTOMER NAME) (ATTENTION)

 (STREET ADDRESS - NO P.O. BOX NUMBERS) (APT.NO.)

 (CITY) (PROVINCE) (POSTAL CODE)

DAYTIME TELEPHONE AREA CODE () _____

Servicing Your Escort

Service Made Easy

Ford has two goals for servicing your vehicle.

1. When we can, we design parts that do not need to be serviced.
2. We want to make servicing your vehicle as easy as possible. To help you:
 - We highlight do-it-yourself items in yellow in the engine compartment so that you can find them easily.
 - When possible, we design parts — such as the headlamp bulbs — that can be replaced without tools.
 - We give you a Maintenance Schedule that makes tracking routine service for your vehicle easy. The maintenance schedule is located in the *Maintenance Schedule and Record* booklet.

This chapter tells you about the basic parts that you need to check and service regularly.

If your vehicle needs professional servicing, your dealership can provide the parts and service required. Check your *Warranty Information Booklet* to find out which parts and services are covered. Also see the *Customer Assistance* chapter of this owner guide.

For more information concerning the maintenance and service of your vehicle, see *Understanding the Emission Control System* in this chapter.

Ford Motor Company recommends that the Owner Maintenance Checks listed in the *Maintenance Schedule and Record* booklet be performed for the proper operation of your vehicle. In addition to the conditions listed in the *Owner Maintenance Checklist*, be alert for any unusual noise, vibration, or other indication that your vehicle may need service. If you do notice something unusual, see that your vehicle is serviced promptly.

Use only recommended fuels, lubricants, fluids, and service parts conforming to Ford specifications. Motorcraft parts are designed and built to provide the best performance in your vehicle. Using these parts for replacement is your assurance that Ford-built quality stays in your vehicle.

NOTE: Always dispose of used automotive fluids in a responsible manner. Follow your community's standards for disposing of these types of fluids. Call your local recycling center to find out about recycling automotive fluids.

Precautions When Servicing Your Vehicle

Be especially careful when inspecting or servicing your vehicle. Here are some general precautions for your safety:

- Do not work on a hot engine. The engine cooling fan may come on unexpectedly. Always turn the engine off and let it cool.

⚠ WARNING
The cooling fan is automatic and may come on at any time. Always disconnect the negative terminal of the battery before working near the fan.

- If you must work with the engine running, avoid wearing loose clothing or jewelry that could get caught in moving parts. Take appropriate precautions with long hair.
- Do not work on a vehicle in an enclosed space with the engine running, unless you are sure you have enough ventilation.
- Never get under a vehicle while it is supported only by a jack. If you must work under a vehicle, use safety stands.
- Keep all lit cigarettes and other smoking materials away from the battery and all fuel-related parts.

If you disconnect the battery, the engine must “relearn” its idle conditions before your vehicle will drive properly. To find out how the engine does this, see *Starting your vehicle’s fuel-injected engine* in the Index.

Working with the engine off:

1. Set the parking brake fully and make sure that the gearshift is securely latched in Park (automatic transaxle) or First (manual transaxle).
2. Remove the key from the ignition after you turn the engine off.
3. Block the wheels. This will prevent your vehicle from moving unexpectedly.

Working with the engine on:

1. Set the parking brake fully and make sure the gearshift is securely latched in P (Park) (automatic transaxle) or Neutral (manual transaxle).
2. Block the wheels. This will prevent your vehicle from moving unexpectedly.

 WARNING
Do not start your engine with the air cleaner removed and do not remove it while the engine is running.

Opening the Hood

1. Inside the vehicle, pull the hood release handle located under the bottom left corner of the instrument panel.
2. Go to the front of the vehicle and release the auxiliary latch that is located under the hood at the center of the vehicle.
3. Lift the hood and secure it in the open position with the prop rod.

When you close the hood, make sure the prop rod is in its retainer and that the hood latches securely.

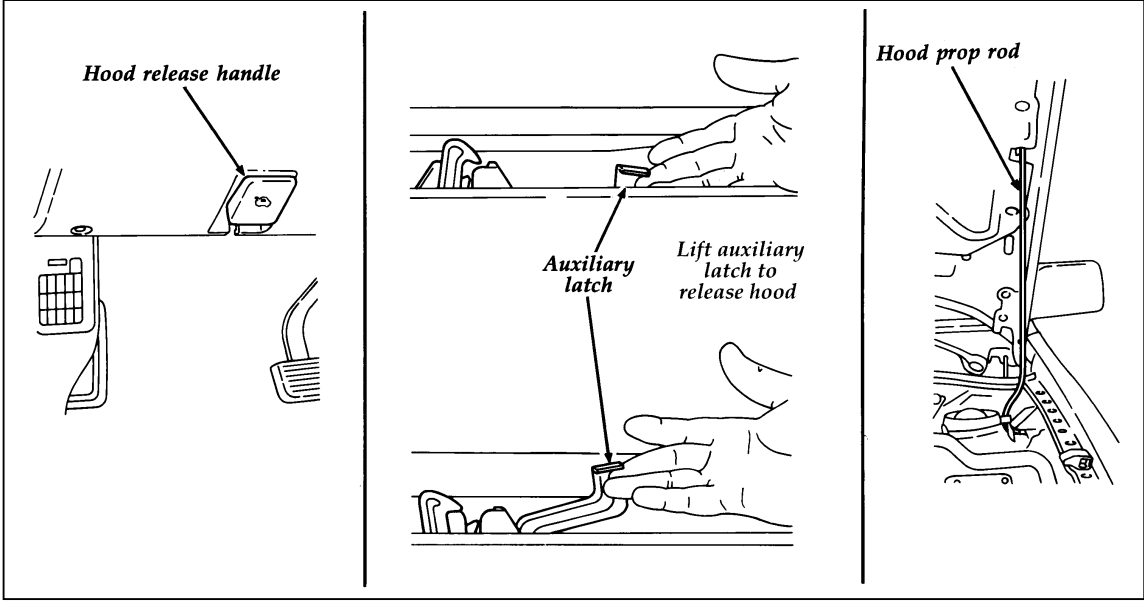

The hood release handle, auxiliary latch, and the hood prop rod.

⚠ WARNING

Read and understand *Precautions When Servicing Your Vehicle* at the beginning of this chapter before opening the hood.

Engine Compartment

Your vehicle has one of these types of engines:

- a 1.9L SFI engine
- a 1.8L DOHC MFI engine

The following pages show diagrams of each engine type and where to find items that you should regularly service. The items most frequently checked or serviced by the owner will be highlighted in yellow.

The 1.9L Engine

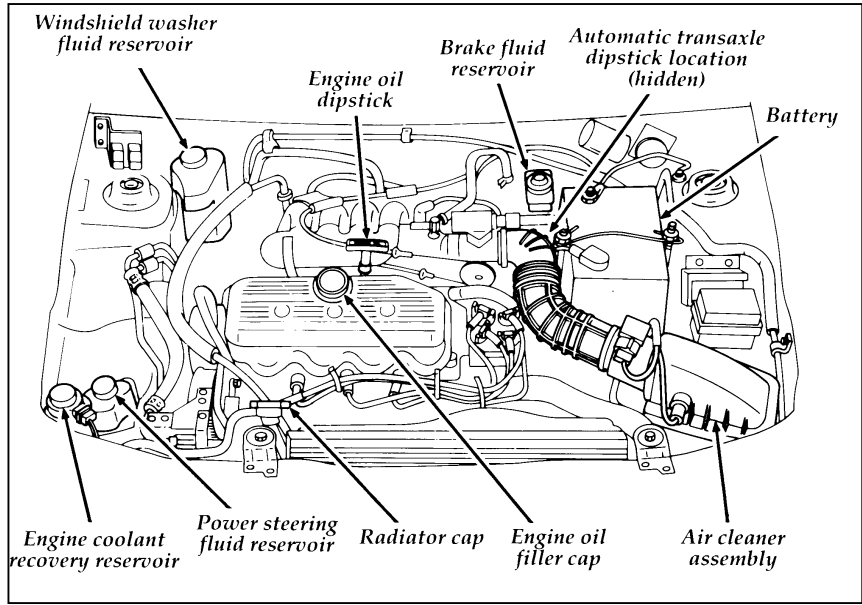

The 1.8L Engine

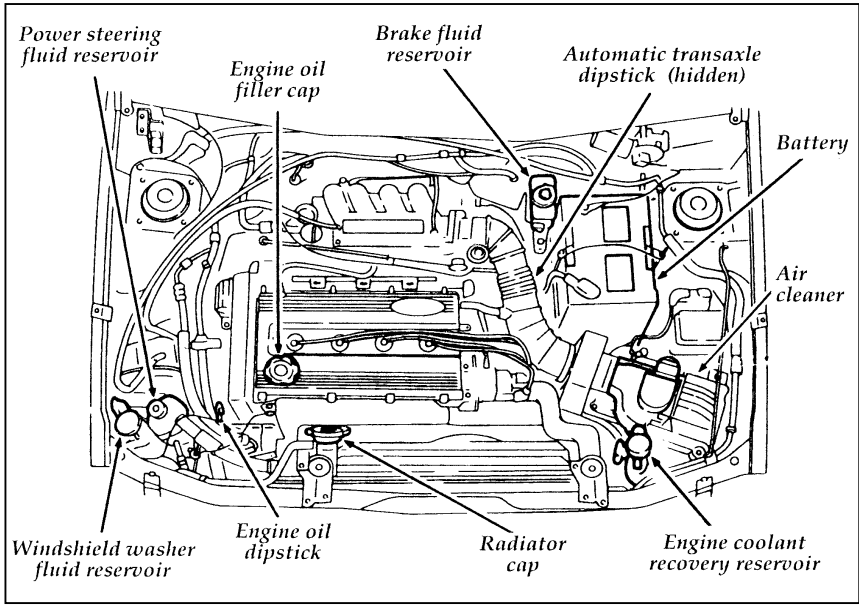

Cleaning the Engine

A clean engine is more efficient because a buildup of grease and dirt acts as an insulator, keeping the engine warmer than normal.

- Extreme care must be used if a power washer is used to clean the engine. The high pressure fluid could penetrate sealed parts and assemblies causing damage or malfunctions.
- In order to avoid possible cracking of the engine block or fuel injection pump, do not spray a hot engine or injection pump with cold water.
- The alternator, distributor and air intake must be covered. Covering these components will help prevent water damage.
- Never wash or rinse the engine while it is running. Water getting into the engine may cause internal damage.

Filling the Fuel Tank

The fuel filler door can be opened by pulling on the finger hold located on the rear edge of the fuel filler door.

For your convenience, a fuel filler door location indicator is included in your instrument cluster. It indicates which side of your vehicle contains the fuel filler door.

The fuel filler door is outside the vehicle on the driver side near the back.

1. Turn the ignition switch to the OFF position and remove the key. To remove the fuel cap, turn it counterclockwise.

⚠ WARNING

If the fuel cap is venting vapor or if you hear a hissing sound, wait until it stops before completely removing the cap.

2. Make sure that you pump unleaded fuel and put the nozzle all the way inside the fuel filler pipe.
3. If you spill any fuel on the body of your vehicle, clean it off immediately. The fuel may dull or soften the paint if you do not wash it off.
4. Replace the fuel cap tightly when you are finished. Turn it clockwise until you hear at least three clicks. The ratcheting mechanism allows the fuel cap to be sealed without overtightening.
5. Push the fuel door closed.

If you lose the fuel cap, replace it with an authorized Motorcraft or equivalent part.

⚠ WARNING

If you do not use the proper fuel cap, the pressure in the fuel tank can damage the fuel system or cause it to work improperly in a collision.

NOTE: If you replace your fuel cap with an aftermarket fuel filler cap, the customer warranty may be void for any damage to the tank and/or fuel system.

Choosing the Right Fuel

Use only UNLEADED FUEL in your vehicle. Using leaded fuel is prohibited by federal law. Your warranty may not apply if your vehicle is damaged because you used the wrong fuel.

Vehicle inspection programs may detect misfueling. Under these circumstances, you may be required by law to make costly repairs at your own expense.

Octane Recommendations

Your vehicle is designed to use regular fuel with an octane rating of 87. In most cases it is not necessary to use a fuel with an octane rating higher than 87. At service stations, the octane rating is displayed in a label on the pumps.

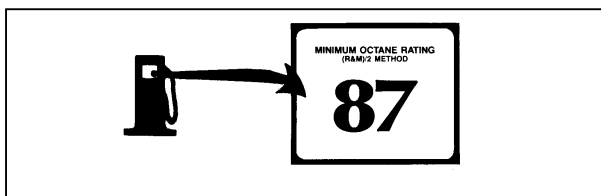

In some parts of the country, “regular” grade fuels are sold with octane ratings of 86 or even less, especially in high altitude areas. We recommend that you do not use these fuels. Always use a fuel with an octane rating of 87, even if it is sold as a “midgrade” or “premium.”

Do not be concerned if your vehicle sometimes knocks lightly when you drive up a hill or when you accelerate. However, if a fuel with the recommended rating knocks heavily under all driving conditions or knocks lightly driving at cruising speed on level roads, see your dealer or a qualified service technician. Persistent, heavy knocking can damage the engine.

Fuel Quality

If you are experiencing starting, rough idle or hesitation problems when the engine is cold, it may be caused by fuel with low volatility. Try a different brand of fuel. If the condition persists, see your dealer or a qualified service technician.

Using a high-quality fuel makes your vehicle more responsive and maintains its good fuel economy and emissions by:

- protecting your fuel system from rusting.
- protecting your fuel lines from freezing.
- improving vehicle starting and warm-up.
- protecting the fuel system from vapor lock in very hot weather, which causes the engine to hesitate or stall and makes restarts difficult.
- minimizing deposits in fuel injectors, combustion chambers and on intake valves.
- preventing the fuel system from “gumming up” when your vehicle is not used for long periods of time.

It should not be necessary to add any aftermarket products to your fuel tank if you continue to use a high-quality fuel.

Gasolines for Clean Air

Fuels in certain areas of the country are required to contain oxygenates to improve air quality. Common oxygenates are ethanol or grain alcohol (blended at no more than 10%), methanol or wood alcohol (blended at no more than 5% with cosolvents and additives) and MTBE or methyl tertiary butyl ether (blended at no more than 15%).

Reformulated fuel is also required in certain areas of the U.S. These fuels are designed to further reduce emissions from your vehicle.

Generally, you should not experience difficulties operating your vehicle on reformulated gasoline or on fuels containing oxygenates. We encourage you to use these fuels.

Safety Information Relating to Automotive Fuels

 WARNING
--

Automotive fuels can cause serious injury or death if misused or mishandled.

- Turn vehicle off when refueling
- Do not smoke when refueling. Fuels are extremely flammable.
- Do not siphon any fuel by mouth.

 WARNING
--

Gasoline or gasoline blended with methanol can cause blindness and possible death when swallowed. If any fuel is swallowed, call a physician or poison control center immediately.

- Avoid breathing vapors while refueling.
- If fuel is splashed on the skin, wash with soap and water.
- If fuel is splashed in the eyes, remove contact lenses (if worn), flush with water for 15 minutes, and seek medical attention.

Gasoline and gasoline blends may contain small amounts of carcinogens, such as benzene. Long-term exposure to unleaded gasoline vapors has caused cancer in laboratory animals.

If you are taking the medication “Antabuse” or other forms of disulfiram for the treatment of alcoholism, vapor or skin contact with a gasoline-methanol blend may cause the same kind of adverse reaction as drinking an alcoholic beverage. In sensitive individuals, serious personal injury or sickness could result. Consult a physician promptly if you experience an adverse reaction.

Running Out of Fuel

NOTE: Avoid running out of fuel because this situation may have an adverse effect on modern powertrain components.

If your vehicle runs out of fuel, try to stop on level ground away from traffic. The engine may be restarted by adding at least one (1) gallon (four liters) of fuel to the fuel tank. If the vehicle is not level, up to three (3) gallons (12 liters) of fuel may be required to start the engine.

You may need to crank the engine several times before the fuel system starts to pump fuel from the tank to the engine.

 WARNING
--

<p>Never pour fuel in the throttle body or attempt to start the engine with the air cleaner removed. Doing so could result in fire and personal injury.</p>
--

Fuel Economy

Fuel economy is an estimate of the efficiency of your vehicle and can be calculated as Miles Per Gallon (MPG) or Liters Per 100 Kilometers (L/100K). Do not calculate the fuel economy during your vehicle’s break-in period. This would not be an accurate estimate of how much fuel your vehicle will normally use.

To calculate fuel economy:

1. Fill the tank completely and record the initial odometer reading.
2. Every time you buy fuel record the amount (in gallons or liters) purchased.
3. After at least three to five tankfuls, fill the fuel tank and record the final odometer reading.
4. Divide the total number of miles that you have driven by the total number of gallons that your vehicle has used. In metric, multiply the number of liters used by 100 and divide the answer by the number of kilometers traveled. This will give you the number of liters used per 100 km.

Comparisons With Environmental Protection Agency (EPA) and Transport Canada (TC) Fuel Economy Estimates

EPA fuel economy figures are obtained from laboratory tests under simulated road conditions and may not reflect the actual conditions you experience or your style of driving. The EPA fuel economy estimate is not a guarantee that you will achieve the fuel economy shown.

Improving Fuel Economy

Fuel economy is affected by a number of variables which can reduce efficiency. You can improve fuel economy by understanding these variables and minimizing their effect.

The following decrease fuel economy:

- Lack of regular, scheduled maintenance
- Excessive speed
- Rapid acceleration

- Driving with your foot on the brake
- Sudden stops
- Extended engine idling
- Using speed control in hilly terrain
- Extended use of the A/C, defroster, rear window defroster and other accessories
- Underinflated tires
- Heavy loads
- Aftermarket add-ons such as bike, ski or luggage racks, bug deflectors, etc.

Engine Oil Recommendations

We recommend using Motorcraft oil or an equivalent oil meeting Ford Specification ESE-M2C153-E and displaying the American Petroleum Institute CERTIFICATION MARK on the front of the container.

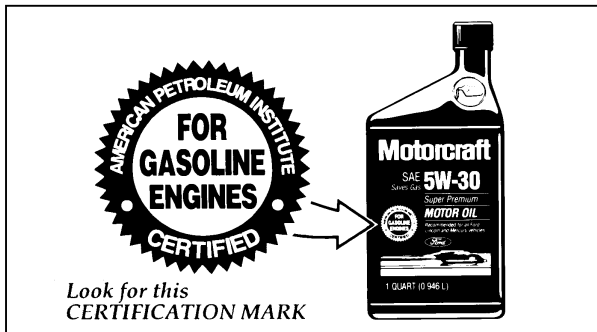

The API Certification Mark

Never use:

- “Non-Detergent” oils
- Oils labeled API SA, SB, SC, SD, SE, SF or SG
- Additional engine oil additives, oil treatments or engine treatments

Engine oils with an **SAE 5W-30** viscosity are **PREFERRED** for your vehicle. They provide the best engine performance, fuel economy and engine protection for all climates down to -15°F (-25°C).

Synthetic engine oils which are **CERTIFIED** and of the preferred viscosity may be used in your engine. The engine oil and oil filter must still be changed according to the maintenance schedule.

Checking and Adding Engine Oil

Since the proper amount of engine oil is important for safe engine operation, check the oil using the dipstick each time you put fuel in your vehicle. Remember the engine must be off, the oil must be warm and the vehicle must be parked on level ground.

Checking the engine oil level:

1. Turn the engine off after it has warmed up and allow a few minutes for the engine oil to drain back into the oil pan.
2. Set the parking brake fully and make sure that the gearshift is securely latched in P (Park) (automatic transaxle) or 1 (First) (manual transaxle).
3. Open the hood. Protect yourself from engine heat.
4. Locate the engine oil dipstick (highlighted in yellow) and carefully pull it out of the engine.
5. Wipe the dipstick clean and put it back into position, making sure it is fully seated.

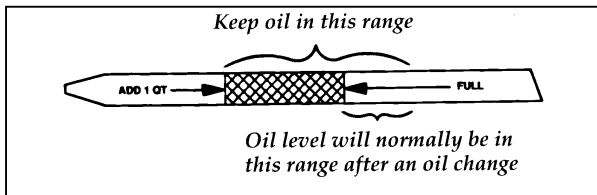

Engine oil dipstick (1.9L engine)

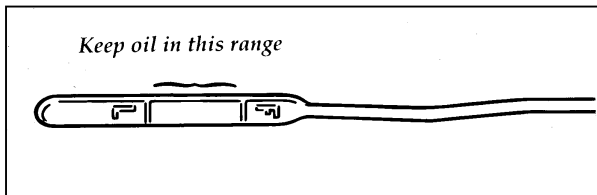

Engine oil dipstick (1.8L engine)

6. Carefully pull the dipstick out again. If the oil level is below the “Add 1 qt.” or “L” line, add engine oil as necessary. If the engine oil is beyond the letter “F” or the “FULL” line, engine damage or high oil consumption may occur and some oil must be removed from the engine.
7. Put the dipstick back in and make sure it is fully seated.

Adding engine oil

It may be necessary to add some oil between oil changes. Make sure you use a CERTIFIED engine oil of the preferred viscosity. Your vehicle’s warranty coverage may not apply if engine damage is caused by the use of improper engine oil.

Add engine oil through the oil filler cap highlighted in yellow. To add oil, remove the filler cap and use a funnel to pour oil into the opening. Be careful not to overfill the engine. Recheck the oil level after you finish adding oil.

5,000 MILES (8,000 KM) OR 6 MONTHS
NORMAL SCHEDULE

3,000 MILES (5,000 KM) OR 3 MONTHS
SEVERE DUTY SCHEDULE

EXTENSIVE IDLING
TRAILER TOWING
DRIVING IN SEVERE DUST
POLICE, TAXI, OR DELIVERY

⚠ WARNING

Continuous contact with USED motor oil has caused cancer in laboratory mice.

Protect your skin by washing with soap and water.

Engine Coolant

Checking the Engine Coolant

NOTE: Be sure to read and understand *Precautions When Servicing Your Vehicle* at the beginning of this chapter.

⚠ WARNING

The cooling fan is automatic and may come on at any time. Always disconnect the negative terminal of the battery before working near the fan.

Check the engine coolant level in the engine coolant recovery reservoir at least once a month. The coolant should be between the Full Hot and Full Cold marks on the reservoir. To locate the reservoir, see the diagram of your vehicle's engine under *Engine compartment* in this chapter.

⚠ WARNING

Do not put engine coolant in the container for the windshield washer fluid.

If sprayed to clean the glass, engine coolant or antifreeze could make it difficult to see through the windshield.

NOTE: Additional illumination may be needed to see the coolant reservoir markings clearly.

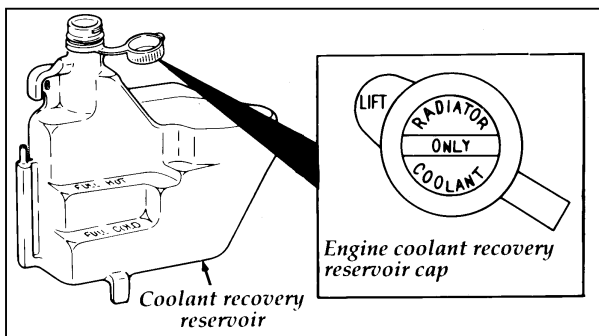

The engine coolant reservoir

If the engine coolant has not been checked for a long period of time the engine coolant reservoir may eventually empty. If the engine coolant reservoir empties, check the engine coolant level in the radiator. Read the following instructions before removing the radiator cap. If it is necessary to fill the radiator, refer to the *Refill Capacities* chart later in this chapter.

⚠ WARNING

Failure to follow these instructions could result in serious personal injury from hot engine coolant or steam blowout and/or damage to the engine cooling system or engine.

1. Before you remove the radiator cap, turn the engine off and let it cool. Even when the engine is cool, be careful when you remove the radiator cap.
2. When the engine is cool, wrap a thick cloth around the cap and turn it slowly counterclockwise to the first stop.
3. Step back while the pressure releases.
4. When you are sure that all the pressure has been released, use the cloth to press, turn, and remove cap.
5. Stand away from the radiator opening. Hot steam may blow out or hot engine coolant may even splash out.

Adding Engine Coolant

 WARNING
--

Never remove the coolant recovery cap while the engine is running or hot.
--

To find out how much engine coolant mixture your vehicle's coolant system can hold, see *Refill capacities for fluids* in the Index.

Ford Premium Cooling System Fluid is an optimized formula that will protect all metals and rubber elastomers used in Ford engines for four years or 50,000 miles (80,000 km). It is not necessary and not recommended to use supplemental coolant additives in your gasoline powered vehicle. These additives may harm your engine cooling system. Follow the recommended service interval for changing your engine coolant.

NOTE: When you change or add engine coolant, it is important to maintain your engine coolant concentration between 40% (-11°F [-24°C]) and 60% (-62°F [-52°C]), depending on your local climate conditions. Below 40% you will lose freeze protection and above 60% your engine may overheat on a warm day.

NOTE: The use of an improper coolant may void your warranty for the engine cooling system. Use only a premium, nationally recognized brand name engine coolant. Do not use alcohol, methanol antifreeze or engine coolant mixed with alcohol or methanol antifreeze. If you do not use the proper coolant, the aluminum engine on your vehicle will corrode.

Ford Motor Company expressly authorizes the Ford Rotunda engine coolant recycling process and chemicals. Use only Ford Rotunda recycled engine coolant or an equivalent non-Ford Rotunda recycled engine coolant that is certified by the supplier to meet Ford specification ESE-M97B44-A.

NOTE: Always dispose of used automotive fluids in a responsible manner. Follow your community's standards for disposing of these types of fluids. Call your local recycling center to find out about recycling automotive fluids.

Use Ford Premium Cooling System Fluid E2FZ-19549-AA (in Canada, Motorcraft CXC-8-B) or an equivalent engine coolant that meets Ford Specification ESE-M97B44-A.

Leave the engine coolant in all year. Make sure that the coolant will not freeze at the temperature level in which you drive during winter months. Keep an engine coolant in your engine that has a protection rating of at least -20°F (-29°C), or whatever protection rating is appropriate for the climate in which you live.

You may add water by itself only in an emergency, but you should replace it with a 50/50 mixture as soon as possible.

Have your dealer check the engine cooling system for leaks if you have to add a quart (liter) of engine coolant more than once a month.

Checking Hoses

Inspect all engine and heater system hoses for deterioration, leaks and loose clamps before adding or replacing engine coolant. Make whatever repairs or replacements are necessary using Motorcraft parts or their equivalents.

Windshield Washer Fluid and Wipers

Washer Fluid

The windshield washer reservoir is located in the engine compartment.

 **WARNING**

Do not put windshield washer fluid in the container for the engine coolant.

Use specially formulated windshield washer fluid rather than plain water, because specially formulated washer fluids contain additives that dissolve road grime. For safety reasons, washer fluids containing an appropriate antifreeze such as methanol should be used in freezing weather

(temperatures below 32°F [0°C]). State or local regulations on Volatile Organic Compounds (VOC's) may restrict use of the most common antifreeze, methanol. Washer fluids containing non-methanol antifreeze agents should be used only if they provide cold weather protection without damaging the vehicle's paint finish, wiper blades, and windshield washer system.

Washer Fluid for the Liftgate (Wagon only — if equipped)

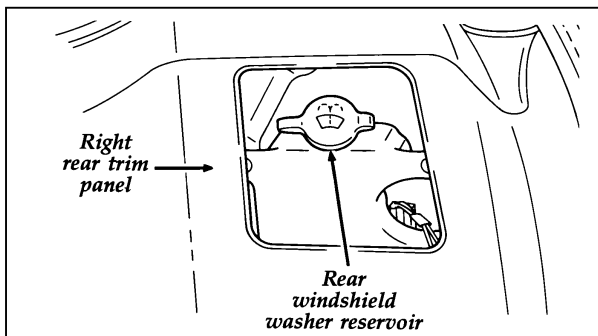

Location of the rear windshield washer reservoir

The wagon's rear reservoir is located on the passenger side of the storage compartment. You must remove the access cover to find the washer reservoir cap. The reservoir must be filled slowly to allow air trapped in the reservoir to escape.

Wiper Blades

Check the windshield wiper blades at least twice a year. Also check them whenever they seem less effective than usual. Substances such as tree sap and some hot wax treatments used by commercial car washes reduce the effectiveness of wiper blades.

If the blades do not wipe properly, clean both the windshield and the wiper blades. Use undiluted windshield washer solution or a mild detergent. Rinse thoroughly with clear water. Do not use fuel, kerosene, paint thinner, or other solvents to clean your wiper blades. These will damage your blades.

Inspect the wiper arm pivots on a regular basis to ensure that the wiper arms move freely. Lubricate the pivot points if necessary.

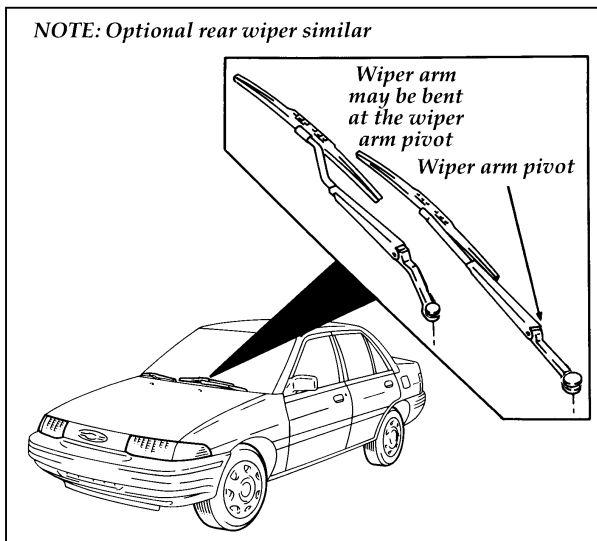

Wiper arm pivot points

To make reaching the wiper blades easy, simply turn the ignition switch to the ON position and turn the wipers on. Wait for them to reach a vertical position and turn the ignition to OFF. Do not move the wipers manually. Manually moving the wipers across the windshield may damage them.

Wiper blade replacement

If the wiper blades still do not work properly after you clean them, you may need to replace the wiper blade assembly or the blade element. When replacing the wiper blade assembly, blade refill, or wiper arm always use a Motorcraft part or equivalent.

NOTE: There are two different length wiper blades on your vehicle. The driver-side wiper blade is 20 inches (50 cm) long, and the passenger-side wiper blade is 17 inches (45 cm) long. Ensure that you install the correct size wiper blade in the correct location.

To replace the wiper blades:

1. Pull the wiper arm away from the windshield and lock into the service position.
2. Turn the blade at an angle from the wiper arm. Push the lock pin with a screwdriver to release the blade and pull the wiper blade down toward the windshield to remove it from the arm.
3. Attach a new wiper blade to the wiper arm and press it into place until you hear it click.

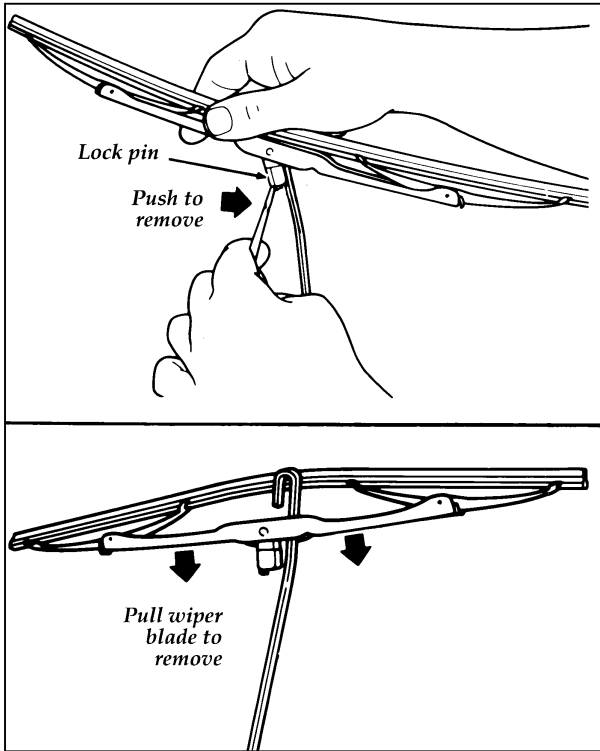

Replacing the wiper blades

Tires

Look at your tires each time you fill your fuel tank. If one tire looks lower than the others, check the pressure in all of them. Always follow these precautions:

- Keep your tires inflated to the recommended pressures.
- Stay within the recommended load limits (see *Load limits* in the Index).
- Make sure the weight of your load is evenly distributed.
- Drive at safe speeds.

If you do not take these precautions, your tires may fail or go flat.

 WARNING
Driving too fast for conditions creates the possibility of loss of vehicle control. Driving at very high speeds for extended periods of time may result in damage to vehicle components.

At least once a month, check the pressure in all your vehicle's tires, including the spare. Use an accurate tire pressure gauge. Check the tire pressure when tires are cold, after the vehicle has been parked for at least one hour or has been driven less than 3 miles (5 km). You can find proper cold pressure and load limits of recommended size tires on the Safety Compliance Certification Label.

⚠ WARNING

Improperly inflated tires can affect vehicle handling and can fail suddenly, possibly resulting in loss of vehicle control.

Tire Rotation

Because your vehicle's front and rear tires perform different jobs, they often wear differently. To make sure your tires wear evenly and last longer, rotate them as indicated in the following diagram.

Do not include the spare tire as part of your rotation.

For tire rotation intervals, see the *Maintenance Schedule and Record* booklet. If you notice the tires wearing unevenly, have them checked.

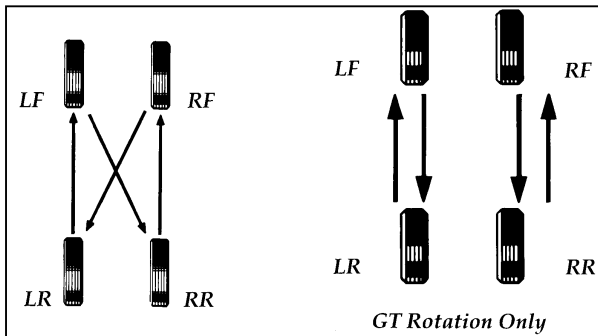

Rotating the tires

Replacing the Tires

Replace any tires that show wear bands. When your tire shows a wear band, it has only 1/16 inch (2 mm) of tread left.

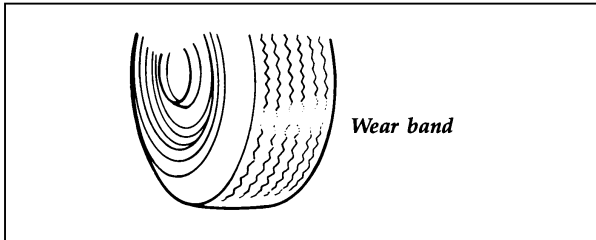

A worn-out tire

Because your vehicle's tires may wear unevenly, you may need to replace them before a wear band appears across the entire tread. Some spots wear more heavily than others.

⚠️ WARNING

When replacing full size tires, never mix radial, bias-belted, or bias-type tires. Use only the tire sizes that are listed on the tire pressure decal. Make sure that all tires are the same size, speed rating, and load-carrying capacity. Use only the tire combinations recommended on the decal. If you do not follow these precautions, your vehicle may not drive properly and safely.

If you have the standard Escort 2-door hatchback, the correct tire size for your vehicle is P175/70R13. If you have the Escort GT, the correct tire size for your vehicle is P185/60R15.

If you have an Escort LX 2-door hatchback, an Escort 4-door hatchback, an Escort wagon, or an Escort sedan, the correct tire size for your vehicle is P175/65R14.

Tires that are larger or smaller than your vehicle's original tires may also affect the accuracy of your speedometer.

Wheel and Tire Matching

See an authorized tire dealer for proper servicing procedures. Wheels and tires must be properly removed, matched and remounted to maintain the best possible ride.

Information About Tire Quality Grades

New vehicles are fitted with tires that have their Tire Quality Grade (described below) molded into the tire's sidewall. These Tire Quality Grades are determined by standards that the United States Department of Transportation has set.

Tire Quality Grades apply to new pneumatic tires for use on passenger cars. They do not apply to deep tread, winter-type snow tires, space-saver or temporary use spare tires, tires with nominal rim diameters of 10 to 12 inches or limited production tires as defined in Title 49 Code of Federal Regulations Part 575.104(c)(2).

U.S. Department of Transportation — Tire quality grades: The U.S. Department of Transportation requires Ford to give you the following information about tire grades exactly as the government has written it.

Treadwear

The treadwear grade is a comparative rating based on the wear rate of the tire when tested under controlled conditions on a specified government test course. For example, a tire graded 150 would wear one and one-half (1 1/2) times as well on the government course as a tire graded 100. The relative performance of tires depends upon the actual conditions of their use, however, and may depart significantly from the norm due to variations in driving habits, service practices and differences in road characteristics and climate.

Traction A B C

The traction grades, from highest to lowest, are A, B, and C, and they represent the tire's ability to stop on wet pavement as measured under controlled conditions on specified government test surfaces of asphalt and concrete. A tire marked C may have poor traction performance. Warning: The traction grade assigned to this tire is based on braking (straightahead) traction tests and does not include cornering (turning) traction.

Temperature A B C

The temperature grades are A (the highest), B, and C, representing the tire's resistance to the generation of heat and its ability to dissipate heat when tested under controlled conditions on a specified indoor laboratory test wheel. Sustained high temperature can cause the material of the tire to degenerate and reduce tire life, and excessive temperature can lead to sudden tire failure. The grade C corresponds to a level of performance which all passenger car tires must meet under the Federal Motor Vehicle Safety Standard No. 109. Grades B and A

represent higher levels of performance on the laboratory test wheel than the minimum required by law. **Warning:** The temperature grade for this tire is established for a tire that is properly inflated and not overloaded. Excessive speed, underinflation, or excessive loading, either separately or in combination, can cause heat buildup and possible tire failure.

Snow Tires and Chains

The tires on your vehicle have all-weather treads that provide traction in rain or snow. However, during the winter months in some climates, you may need to use snow tires and occasionally chains for your tires.

 WARNING
--

Snow tires must be the same size and grade as the tires you currently have on your vehicle.
--

Use chains on the tires only in an emergency or if the law requires them where you live. If you choose to use chains on your vehicle's tires, be aware of the following:

- Local regulations may prohibit or restrict the use of tire chains. Investigate the laws and regulations in your area before installing chains.
- Tire chains may scratch or chip aluminum wheels. **IT IS RECOMMENDED THAT TIRE CHAINS ARE INSTALLED ON STEEL WHEELS ONLY.** Be sure to remove wheel covers (if equipped) from steel rims before using tire chains to avoid scratches or damage.
- Do not use tire chains if you have the GT model.

- Make sure the chains are the right size for your tires. Use only SAE Class “S” chains. Other types may damage your vehicle.
- Put the chains on the front tires tightly with the ends held down securely. Retighten the chains after driving 1/2 mile (0.8 km). Follow the chain manufacturer’s instructions.
- Do not drive faster than 30 mph (50 km/h) or the chain manufacturer’s recommended speed limit, whichever is lower. Avoid bumps, holes and sharp turns. If you can hear the chains rub or bang against your vehicle, remove the chains to prevent damage to your vehicle.
- Tire chains may affect vehicle handling. Drive carefully and avoid hard braking.
- Do not use chains on temporary spare tires. They may damage the vehicle and the tire.

Cleaning the Wheels

Wash the wheels with the same detergent you use to wash your vehicle’s body. Do not use acid-based wheel cleaners, steel wool, abrasives, fuel, or strong detergents. These substances will damage protective coatings. Use tar and road oil remover to remove grease and tar.

NOTE: Before going to a car wash, find out if the brushes are abrasive.

Battery

If the original equipment maintenance-free battery is replaced, it may be replaced by a low-maintenance battery. See *Motorcraft Parts* at the end of this chapter for the proper replacement battery.

The low-maintenance battery has removable vent caps for checking the electrolyte level and adding water. The electrolyte level should be checked at least every 24 months or 24,000 miles (40,000 km) in temperatures up to 90°F (32°C) and more often in temperatures above 90°F (32°C). Keep the electrolyte level in each cell up to the level indicator. Do not overfill.

If the level gets low, refill the battery with distilled water. If necessary, you can add tap water to the battery, provided the water is not hard or does not have a high mineral or alkali content. If the battery needs water quite often, have the charging system checked for a possible malfunction.

If you disconnect the battery, the engine must “relearn” its idle conditions before your vehicle will drive properly. To find out how the engine does this, see *Starting your vehicle’s fuel-injected engine* in the Index.

If the battery has been disconnected, you will have to reset the clock and the preset stations on your radio once the battery is reconnected.

Help Us Protect Our Environment

Ford Motor Company strongly recommends that used lead-acid batteries be returned to an authorized recycling facility for disposal.



Battery recycling symbol

Because your vehicle's engine is electronically controlled by a computer, some control conditions are maintained by power from the battery. If you ever disconnect the battery or install a new battery, you must allow the computer to relearn its idle conditions before your vehicle will drive properly. To begin this process put the gearshift in P (Park) (automatic transaxle) or Neutral (manual transaxle), turn off all the accessories, and start the vehicle. Let the engine idle for at least one minute. The relearning process will complete automatically as you drive the vehicle.

If you do not let the engine relearn its idle, the idle quality of your vehicle may be adversely affected until the idle is relearned. Your vehicle will eventually relearn its idle while you drive it, but it takes much longer than if you use the previous procedure.

Automatic Transaxle Fluid

Under normal circumstances, you do not need to check the fluid level of the transaxle, since your vehicle does not use up transaxle fluid. Refer to the *Maintenance Schedule and Record* booklet for replacement intervals. However, if the transaxle is not working properly — for instance, the transaxle may slip or shift slowly, or you may notice some sign of fluid leakage — the fluid level should be checked.

NOTE: If the vehicle has been operated for an extended period at high speeds, driven in city traffic during hot weather, or has been pulling a trailer, the vehicle should be turned off for about 30 minutes to allow the fluid to cool before checking.

Checking the Automatic Transaxle Fluid

It is preferable to check the transaxle fluid level at normal operating temperature after approximately 20 miles (32 km) of driving.

With the vehicle on a level surface and the brake pedal fully applied, start the engine and move the gearshift selector through all of the gears. Allow sufficient time for each position to engage. Securely latch the gearshift selector in the P (Park) position. Fully set the parking brake and leave the engine running.

Wipe off the dipstick cap and pull the dipstick out. Wipe the indicator end clean. Put the dipstick back into the filler tube and make sure it is fully seated. Pull the dipstick out and read the fluid level.

When checking fluid at the normal operating temperature, the fluid level should be within the normal operating temperature marks on the

dipstick. When the vehicle has not been driven, and outside temperatures are above 68°F (20°C), the fluid levels should be between the room temperature marks on the dipstick.

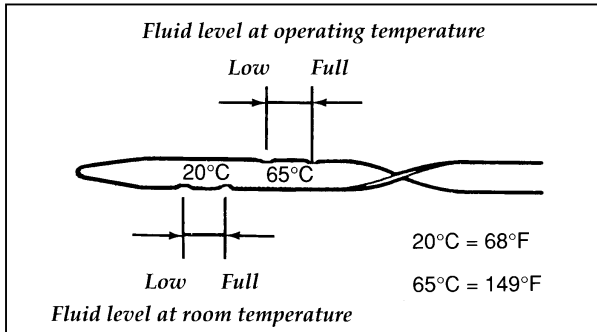

Automatic transaxle fluid dipstick

NOTE: Your vehicle should not be driven if the outside temperature is above 68°F (20°C) and the fluid level is below the Low mark on the room temperature scale.

Adding Automatic Transaxle Fluid

Before adding any fluid, be sure that the correct type will be used.

Add fluid in 1/2 pint (.25 L) increments through the filler tube to bring the level to the correct area on the dipstick. If an overfill occurs, excess fluid should be removed by a qualified technician.

When you are finished adding fluid, be sure to put the dipstick back and ensure that it fits snugly.

NOTE: Always dispose of used automotive fluids in a responsible manner. Follow your community's standards for disposing of these types of fluids. Call your local recycling center to find out about recycling automotive fluids.

Manual Transaxle Fluid

The lubricant level and quality should not deteriorate under normal driving conditions. However, you should have the fluid level checked occasionally. If lubricant is required, see *Lubricant specifications* in the Index.

Brake Fluid

If you have a manual transaxle, the brake fluid reservoir in your vehicle includes the clutch fluid reservoir.

Under normal circumstances, your vehicle should not use up brake fluid rapidly. However, expect the level of the brake fluid to slowly fall as you put more mileage on your vehicle and the brake pads wear.

You should check the brake fluid at every scheduled engine oil change, but be sure to check it at least once a year. You can do this by looking at the fluid level in the plastic reservoir on the master cylinder. (See *The Engine Types* in this chapter to locate the master cylinder.) The fluid level should be at or near the MAX mark.

If the brake fluid level is low, the brake warning light in the instrument cluster will illuminate.

 WARNING
Brake fluid is toxic.

If brake fluid contacts eyes, flush eyes with running water for 15 minutes. Get medical attention if irritation persists. If taken internally, drink water and induce vomiting. Get medical attention immediately.

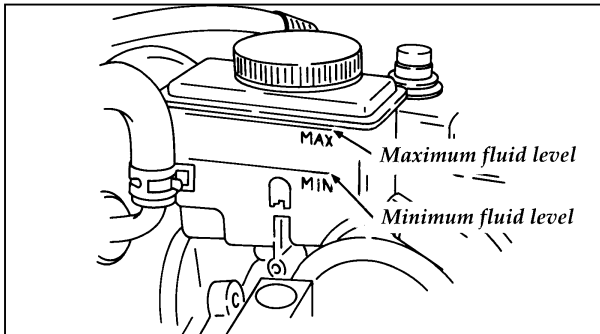

Brake fluid master cylinder reservoir

If the fluid is low, carefully clean and remove the filler cap from the reservoir. Fill the reservoir to the MAX line with Ford High Performance DOT 3 Brake Fluid C6AZ-19542-AA or DOT 3 equivalent fluid meeting Ford specification ESA-M6C25-A.

⚠ WARNING

If you use a brake fluid that is not DOT 3, you will cause permanent damage to your brakes.

Do not fill the reservoir above the MAX line.

NOTE: Avoid spilling brake fluid on painted surfaces.

If you find that the fluid level is excessively low — below the seam or ridge on the outside of the plastic reservoir — have the brake system inspected.

⚠ WARNING

Do not let the reservoir for the master cylinder run dry. This may cause the brakes to fail.

Power Steering Fluid

Check the level of the power steering fluid at least twice a year (i.e., every Spring and Fall).

Checking and Adding Power Steering Fluid

1. Start the engine and let it run until the power steering fluid reaches normal operating temperature. The power steering fluid will be at the right temperature when the engine coolant temperature gauge in the instrument cluster is near the center of the NORMAL operating temperature range.
2. While the engine idles, turn the steering wheel back and forth several times. Make sure that the cap assembly is installed at this time.
3. Turn the engine off.
4. Check the fluid level in the reservoir. The fluid level should be in between the F (Full) and L (Low) markings on the reservoir.
5. If the power steering fluid is low, add fluid in small amounts, continuously checking the level until you reach the F (Full) range. Do not overfill. To find out how much fluid your vehicle's reservoir for the power steering fluid will hold, see *Refill capacities* in the Index.
6. When you are finished, put the reservoir cap back on and make sure that it fits snugly.

Use only power steering fluid that meets Ford Specification ESW-M2C33-F, such as Motorcraft Type “F” Automatic Transmission and Power Steering Fluid.

If the power steering fluid is low, do not drive your vehicle for a long period of time before adding fluid. This can damage the power steering pump.

Fuses, Fuse Links and Circuit Breakers

Fuses, fuse links and circuit breakers protect your vehicle electrical system from overloading. If electrical parts in your vehicle are not working, the system may have been overloaded and blown a fuse, fuse link or tripped a circuit breaker. Before you replace or repair any electrical parts, check the appropriate circuit protector.

The following charts tell you which circuit protector protects each electrical part of your vehicle. If a fuse or fuse link blows, or a circuit breaker opens a circuit, none of the parts of your vehicle that use the circuit will work. For example, if the RADIO fuse is blown, the radio and remote control mirrors will not work. If the radio works, but the electric mirrors don't work, something is wrong with the mirrors.

NOTE: Fuse links should only be repaired by your dealer.

Fuses

If electrical parts in your vehicle are not working, the system may have been overloaded and blown a fuse. If a fuse blows, all the parts of your vehicle that use the fuse will not work.

Your vehicle has two fuse panels. The interior fuse panel is below the instrument panel in front of the driver's door. The main panel is under the hood behind the battery.

The instrument panel fuse panel

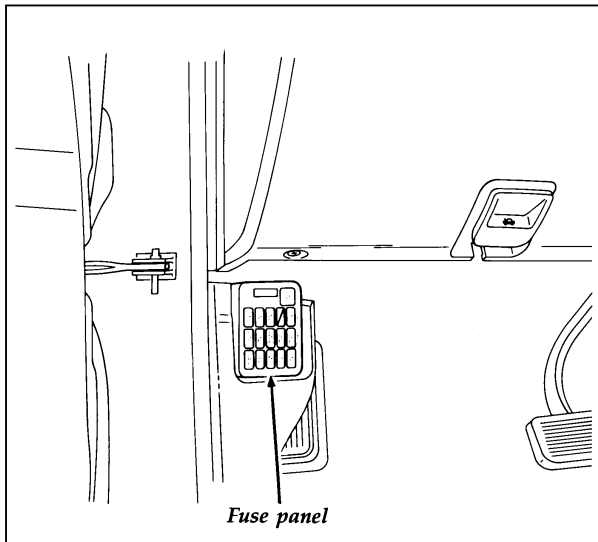

Fuse panel under instrument panel

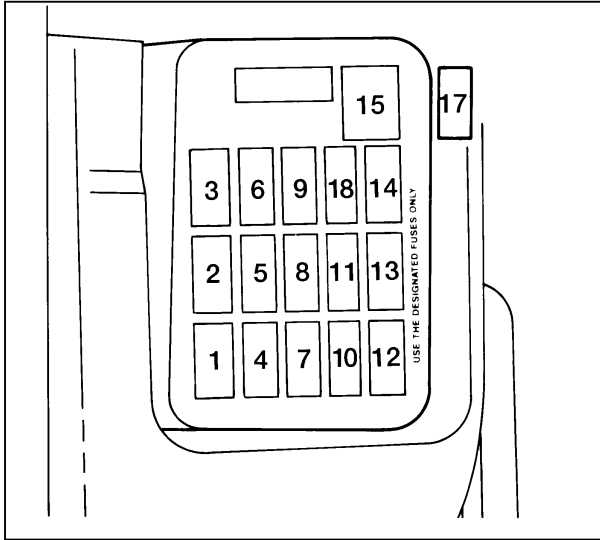

Inside of the instrument fuse panel cover

The instrument panel fuses and circuit breakers

Fuse/C.B. Relay Location	Fuse Amp Rating	Description
1	10 amp	A/C On Indicator, Air Conditioner Relay, Air Conditioner Switch, Daytime Running Lamp Module, Daytime Running Lamp Relay, Rear Wiper and Washer Motor, Wide-Open Throttle Cutout Relay
2	30 amp	Door Lock Motor
3	20 amp	Brakelamp, Electronic Automatic Transaxle Module, Powertrain Control Module, High-Mount Brakelamp, Horn, Shift Interlock System, Speed Control
4	15 amp	Hazard Flashers, Front and Rear Turn Lamp, Turn Indicator Lamp
5	30 amp	Passive Belt Control Module, Passive Belt Motor
6	15 amp	Powertrain Control Module (1.8L engine), Exterior Lamps, Interior Illumination, Parking Lamp Relay, Warning Chime Module

Fuse/C.B. Relay Location	Fuse Amp Rating	Description
7	15 amp 1.8L engine	Dome and Map Lamp, Door Lock Switch, Engine Room, Ignition Key Illumination, Luggage Lamp, Premium Sound Amplifier, Radio (memory), Powertrain Control Module, Shift Interlock System, Visor Mirror Lamp, Warning Chime Module
	15 amp 1.9L engine	
8	30 amp	Power Window Motor
9	15 amp	Moon Roof Motor
10	15 amp	Cooling Fan System, Powertrain Control Module Power Relay
11	15 amp	Air Bag Diagnostic Module, Backup Lamps, Cluster, Flasher Unit, Passive Belt Control Module, Powertrain Control Module (Canada Only), Shift-Lock System, Speed Control, Turn Signal Flashers, Warning Chime
12	15 amp	Instrument Panel Dimmer Module, Radio, Remote Control Mirror

Fuse/C.B. Relay Location	Fuse Amp Rating	Description
13	20 amp	Front Wiper and Washer Motor, Interval Governor, Interval Wiper and Washer Switch
14	20 amp	Powertrain Control Module (1.8L engine), Rear Window Defrost
15	30 amp circuit breaker	Blower Motor, Powertrain Control Module (1.8L engine)
16	10 amp (<u>1.9L engine</u>) 20 amp (<u>1.8L engine</u>)	Heated Exhaust Gas Oxygen Sensor (1.9L engine) (on joint box side, not shown) Horn (on joint box side, not shown)
17	20 amp	Cigar Lighter (on joint box side)
18	10 amp	Anti-lock Brake System (1.8L engine)

The engine compartment fuse panel

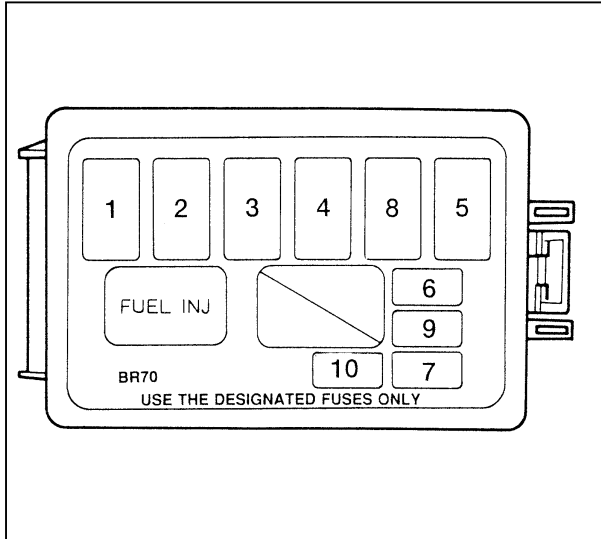

Engine compartment fuse panel (1.8 liter)

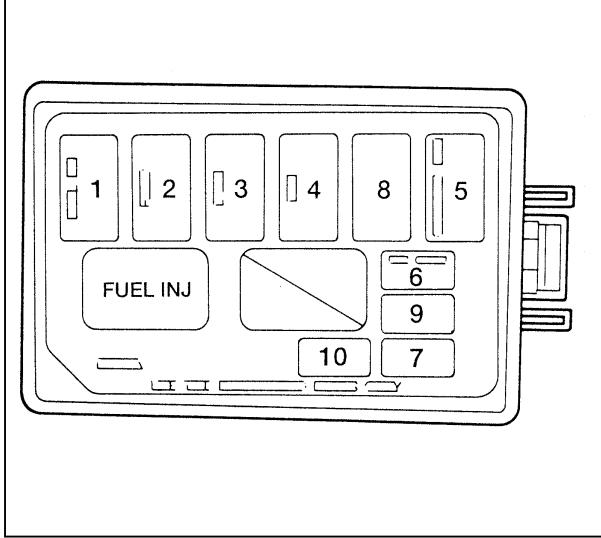

Engine compartment fuse panel (1.9 liter)

Fuse/C.B. Relay Location	Fuse Amp Rating	Description
1	30 amp	Charging System (1.8L Engine), Fuel Injection System
2	30 amp FL	Daytime Running Lamps (Canada), Fog Lamps, Headlamps, High Beam Indicator
3	80 amp FL (1.8L engine) <u>100 amp FL</u> (1.9L engine)	Charging System, Engine Compartment Fuse Panel (ABS, A/C, BTN, Fan, Horn [1.8L Engine]), Engine Controls, Instrument Cluster (Manual Transaxle Only), Instrument Panel Fuse Panel (Cigar, Defrost, Engine ABS, Heater, HEGO [1.9L Engine], Meter, Power Window, Radio, Rear Wiper, Sun Roof), Starting System
4	60 amp FL (1.8L engine) <u>40 amp FL</u> (1.9L engine)	Charging System (1.9L Engine), Instrument Panel Fuse Panel (Belt, Door Lock, Hazard, Room, Stop, Tail)

The engine compartment fuse panel charts

Fuse/C.B. Relay Location	Fuse Amp Rating	Description
5	30 amp (1.8L MTX engine) 40 amp (1.9L engine) (1.8L ATX engine)	Cooling Fan System
6	10 amp (1.9L engine) 20 amp (1.8L engine)	Air Conditioner Magnet Clutch, Powertrain Control Module (1.9L engine)
7	10 amp FL (1.8L engine)	Fuel Pump Relay, Powertrain Control Module
	20 amp (1.9L engine)	Fuel Pump

Fuse/C.B. Relay Location	Fuse Amp Rating	Description
8	60 amp (1.8L engine)	Anti-lock Brake System
9	10 amp	Air Bag Diagnostic Module
10	20 amp (1.8L engine)	Fuel pump
	10 amp (1.9L engine)	OBD-II (Data link connector)

To remove and replace a fuse, use the fuse puller tool provided.

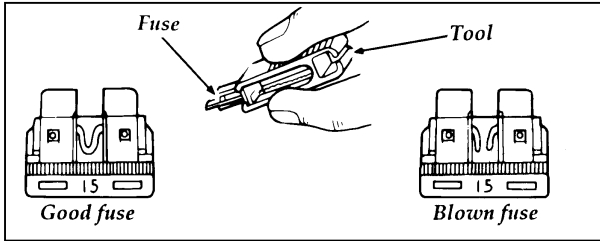

⚠ WARNING

Always replace a fuse with one that has the specified amperage rating. Using a fuse with a higher amperage rating can cause severe wire damage and could start a fire.

To find a fuse's amperage rating, check the number on the fuse or check the color.

Color coding for fuses

Fuse Rating	Color
10 amp	Red
15 amp	Blue
20 amp	Yellow
30 amp	Light Green
30 amp FL	Pink
40 amp	Green
60 amp FL	Yellow
80 amp FL	Black
100 amp FL	Blue

FL = Fuse Link

Even after you replace a fuse, it will continue to blow if you do not find what caused the overload. If the fuse continues to blow, have your electrical system checked.

Circuit Breakers

Circuit breakers open when a circuit overload exceeds their rated current (amperage). The manual reset-type used for the blower motor can be reset by pushing the red button located on top of the circuit breaker. If the overload which caused the circuit breaker to open is still present in the circuit, then the circuit breaker will open again and the red button will pop out. The overload must be removed from the circuit before proceeding.

The non-cycling type used for power seats, power windows, and power door locks will stay open once tripped until the overload is removed.

The circuit breaker chart

Circuit Protected	Size	Location
Blower motor, PCM Module (1.8L engine)	30 amp	Power distribution box above fuse panel

WARNING

Always replace a fuse with one that has the specified amperage rating. Using a fuse with a higher amperage rating can cause severe wire damage and could start a fire.

Lights and Bulb Replacement

It is a good idea to check the operation of the following lights frequently:

- headlamps
- high-mount brakelamp
- tail lamps
- brakelamps
- hazard flasher
- turn signals
- side markers
- license plate lamp
- fog lamps (if equipped)

The alignment of your headlamps should be checked if:

- oncoming motorists frequently signal you to turn off your vehicle's high beams when you do not have the high beams on
- the headlamps do not seem to give you enough light to see clearly at night
- the headlamp beams are pointed substantially away from a position slightly down and to the right

Headlamp Bulb

The headlamps on your vehicle use replaceable bulbs. When the lamp burns out, simply replace the bulb, rather than the whole lamp.

⚠ WARNING

Handle a halogen headlamp bulb carefully and keep out of children's reach. Grasp the bulb only by its plastic base and do not touch the glass. The oil from your hand could cause the bulb to break the next time the headlamps are operated.

Do not remove the burned-out bulb unless you can immediately replace it with a new one. If a bulb is removed for an extended period of time, contaminants may enter the headlamp housing and affect its performance.

Removing the headlamp bulb

1. Make sure that the headlamp knob is in the OFF position.
2. Lift the hood and find the bulb in the headlamp socket.

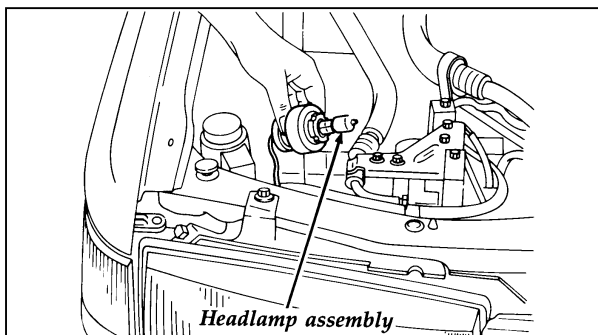

Location of the headlamp bulb

3. Remove the electrical connector from the bulb by pulling the connector.
4. Remove the bulb retaining ring by rotating it counterclockwise (when viewed from the rear) about an eighth of a turn to free it from the bulb socket, and by sliding the ring off the plastic base. Keep the ring. It is to be used again to retain the new bulb.

Installing the headlamp bulb

1. With the flat side of the bulb's plastic base facing upward, insert the glass end of the bulb into the socket. You may need to turn the bulb left or right to line up the grooves in the plastic base with the tabs in the socket. When the grooves are aligned, push the bulb into the socket until the plastic base contacts the rear of the socket.
2. Slip the bulb retaining ring over the plastic base until it contacts the rear of the socket. Lock the ring into the socket by rotating it clockwise until you feel a "stop."
3. Push the electrical connector into the rear of the plastic base until it snaps, locking it into position.
4. Turn the headlamps on and make sure that they work properly. If the headlamp was correctly aligned before you changed bulbs, you should not need to align it again.

High-Mount Brakelamp Bulb

Removing the brakelamp bulb

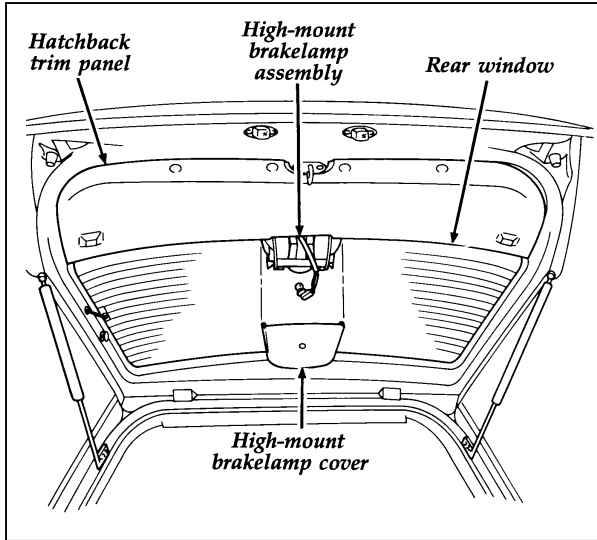

Location of the high-mount brakelamp (GT hatchback brakelamp is on spoiler)

1. Push in the center of each of the three mounting clips and pry each clip out.
2. Remove the high-mount brakelamp cover.
3. Remove the socket that contains the burned-out bulb and replace the bulb.

Installing the brakelamp bulb

1. Push the bulb socket into the lamp assembly.
2. Secure the cover with the mounting clips.

Replacing the brakelamp on a luggage compartment with spoiler

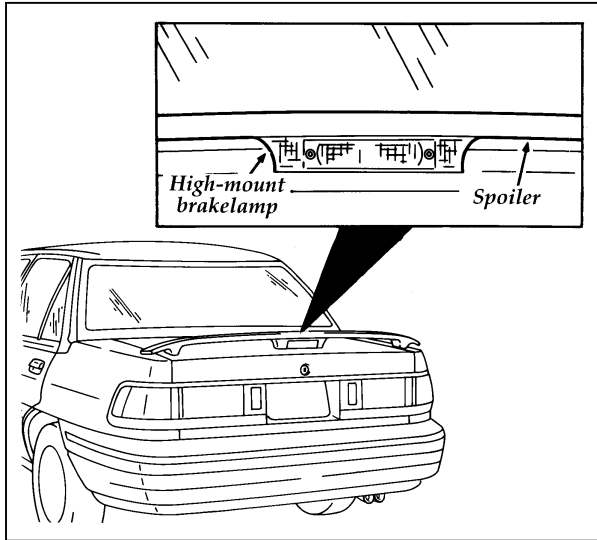

Location of the high-mount brakelamp on spoiler

1. Remove the two retaining screws and the lens.
2. Detach the socket from the housing and remove the bulb.
3. Replace the bulb and ease the socket back into the housing.
4. Replace the lens and secure with the retaining screws.

Replacing a brakelamp mounted on the package tray in the rear window

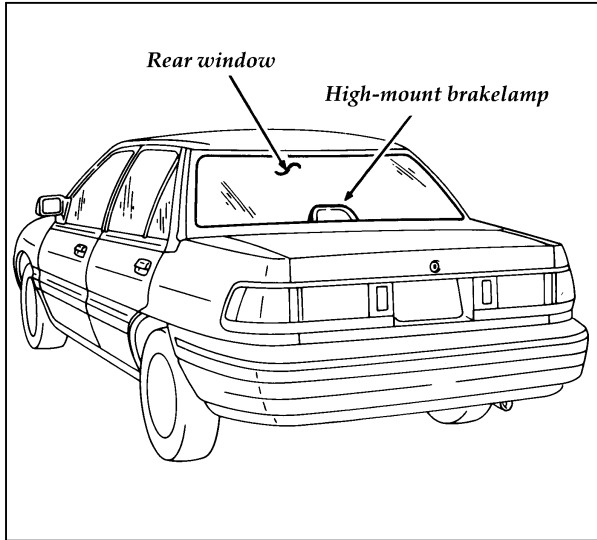

Location of the high-mount brakelamp in rear window

1. Remove the two fastener clips and the brakelamp assembly cover.
2. Detach the socket from the housing and remove the bulb.
3. Replace the bulb and ease the socket back into the housing.
4. Replace the brake assembly cover and secure with the two fastener clips.

Bulb Specifications

Function	Number Of Bulbs	Trade Number
Exterior illumination		
Front park/turn lamps	2	3157K
Fog lamps—(if equipped)	2	881
Headlamps—aero high & low beam	2	9004**
Rear license plate lamp	2	168
2-Door, 4-Door		
High-mount brakelamp	1	921
Hatchback brakelamp/backup lamp/turn lamps	2/4	3157K/ 3156K
Notchback—Backup lamp	2	3156K
Notchback—Brakelamp	2	3156K
Notchback—Rear/turn/sidemarker	2	3357
Liftgate station wagon		
Rear license plate lamp	2	168
Rear side marker lamp	2	168
Interior illumination		
Cargo lamp—liftgate station wagon	1	12V/5W
Dome lamp	1	12V/10W
Dome/map lamp	1/2	12V/6W
Engine compartment lamp	1	D8BB 13465CA (12.8W)
Luggage compartment lamp—(if equipped)	1	5W
“PRNDL” illumination	1	1445
Instrument panel illumination		
A/C control nomenclature	1	14V/3W
A/C indicator	1	14V/ 1.4W
**After removal of three attaching screws, two lower and one upper inboard, the lamp is still retained by a stud into a spring clip which may be easily released by pulling forward on the lamp. Then remove socket and bulb from lamp. Replace bulb and reattach by reversing the above sequence.		

Function	Number Of Bulbs	Trade Number
Instrument panel illumination (continued)		
Rear defroster switch	1	2102
Heater control nomenclature	1	14V/3.0W
High beam indicator	1	194
Instrument panel gauge (cluster)	4	194
Sport cluster w/tach.	5	194
Radio illumination		*
Turn signal indicator	2	194
Upshift indicator (if equipped)	1	194
Warning lights—all	(1 each)	194
*Refer bulb replacement to Ford Authorized Radio Service Center.		

Emission Control System

Your vehicle is equipped with a catalytic converter which enables your vehicle to comply with applicable exhaust emission requirements.

WARNING

Exhaust leaks may result in the entry of harmful and potentially lethal fumes into the passenger compartment. Under extreme conditions excessive exhaust temperatures could damage the fuel system, the interior floor covering, or other vehicle components, possibly causing a fire.

To make sure that the catalytic converter and the other emission control parts continue to work properly:

- Use only unleaded fuel.
- Avoid running out of fuel.
- Do not turn off the ignition while your vehicle is moving, especially at high speeds.
- Have the services listed in the *Maintenance Schedule and Record* booklet performed according to the specified schedule. The scheduled maintenance services are required because they are considered essential to the life and performance of your vehicle and to its emissions system.

In general, maintenance, replacement, or service of the emissions control devices or systems in your new Ford Motor Company vehicle or engine may be performed at your expense by any automotive repair establishment or individual using automotive parts equivalent to those which your vehicle or engine was originally equipped.

If other than Ford or Motorcraft or Ford authorized remanufactured parts are used for maintenance, replacement, or for the service of components affecting emissions control, the owner should be assured that such parts are warranted by their manufacturer to be equivalent to genuine Ford Motor Company parts in performance and durability. Please consult your warranty information booklet for complete warranty information.

⚠️ WARNING

Do not park, idle, or drive your vehicle in dry grass or other dry ground cover. The emission system heats up the engine compartment and exhaust system, which can start a fire.

Do not make any unauthorized changes to your vehicle or engine. Changes that cause more unburned fuel to reach the exhaust system can increase the temperature of the engine or exhaust system.

By law, anyone who manufactures, repairs, services, sells, leases, trades vehicles, or supervises a fleet of vehicles is not permitted to intentionally remove an emission control device or prevent it from working. In some of the United States and in Canada, vehicle owners may be liable if their emission control device is removed or is prevented from working.

Never use a metal exhaust collector when you service your vehicle. If the metal collector contacts any of your vehicle's plastic trim or bumper parts they could melt or deform.

Do not drive your vehicle if it does not operate properly. See your dealer if the engine runs on for more than five seconds after you shut it off or if it misfires, surges, stalls, or backfires.

Information about your vehicle's emission control system is on the Vehicle Emission Control Information decal located on or near the engine. This decal identifies engine displacement and gives some tune-up specifications.

Readiness for Inspection/Maintenance Testing

In some localities it may become a legal requirement to pass an Inspection/Maintenance (I/M) test of the On-Board Diagnostic (OBD) II system. If the vehicle's powertrain system or its battery has just been serviced, the OBD II system is reset to a not ready for I/M testing condition. To prepare for I/M testing, the law specifies a "need for additional mixed city and highway driving to complete the check" of the OBD II system. As soon as all of the OBD II system checks are successfully completed, the OBD II system is set to the ready condition. The amount of driving required to reach the ready condition varies with individual driving patterns. To complete this requirement in the minimum amount of time, refer to the OBD II Drive Cycle defined below. If the vehicle owner cannot or does not want to do the additional driving required by law, a service center can perform this drive cycle as it would any other type of repair work.

OBD II Drive Cycle (1.9L Engine only)

The following steps must be run in the order shown. If any steps are interrupted, repeat the preceding step. Any safe driving mode is acceptable between steps.

NOTE: Always drive vehicle in a safe manner according to traffic conditions and obey all traffic laws.

The engine must be warmed up and at operating temperature before proceeding with the drive modes of the following OBD II Drive Cycle.

1. Start the engine. Drive the vehicle or idle in neutral for 4 minutes.
2. Idle the vehicle in D (drive) (neutral for manual transaxles) for 40 seconds.
3. Accelerate the vehicle to 35 mph (55 km/h) (manual transaxles upshift from 1st to 3rd gear) at 1/2 to 3/4 throttle for 10 seconds.
4. Drive the vehicle with a steady throttle at 35 mph (55 km/h) (manual transaxles use 3rd gear) for 30 seconds.
5. Idle the vehicle in D (drive) (neutral for manual transaxles) for 40 seconds.
6. Continue to drive the vehicle in city traffic at speeds between 25 and 40 mph (40-64 km/h) (manual transaxles primarily use 3rd and 4th gear when possible) for 15 minutes. During the 15 minute drive cycle the following modes must be achieved:
 - a. at least 5 stop and idle modes at 10 seconds each
 - b. acceleration from idles at 1/2 to 3/4 throttle position, and
 - c. choose 3 different speeds to do 1.5 minute steady state throttle drives.
7. Accelerate the vehicle up to between 45 and 60 mph (72-97 km/h) (manual transaxles upshift to 5th gear). This should take approximately 5 minutes.

8. Drive vehicle and hold the throttle steady at the selected speed between 45 and 60 mph (72-97 km/h) for approximately 5 minutes.
9. Drive the vehicle for 5 minutes at varying speeds between 45 and 60 mph (72-97 km/h).
10. Bring the vehicle back to idle. Idle in drive for 40 seconds.
11. OBD II drive cycle has been completed.
Vehicle can be turned off when convenient.

Refill Capacities, Motorcraft Parts, and Lubricant Specifications

Refill Capacities

1.8L Engine		
Component	U.S.	Metric
Cooling System*		
Manual Transaxle	5.3 qts.	5.0 liters
Automatic Transaxle	6.3 qts.	6.0 liters
Engine Oil		
With filter change	4.0 qts.	3.8 liters
Fuel Tank	13.2 gals.	50 liters
Power Steering	1.8 pts.	0.8 liter
Radiator Filler Cap	13 psi	90 kPa
Transaxle		
Automatic Overdrive	4.1 qts.	3.9 liters
5-Speed manual	6.7 pts.	3.2 liters
* Add 50/50 mixture to Full Hot mark in coolant recovery reservoir or to the Full Cold mark for a cold engine. For air conditioning refrigerant information, see your dealer.		

1.9L Engine		
Component	U.S.	Metric
Cooling System*		
Manual Transaxle	5.3 qts.	5.0 liters
Automatic Transaxle	6.3 qts.	6.0 liters
Engine Oil		
With filter change	4.0 qts.	3.8 liters
Fuel Tank	11.9 gals.	45 liters
Power Steering	1.8 pts.	0.8 liter
Radiator Filler Cap		
Automatic Transaxle	16 psi	110 kPa
Manual Transaxle	13 psi	90 kPa
Transaxle		
Automatic Overdrive	4.1 qts.	3.9 liters
5-Speed manual	5.6 pts.	2.7 liters
<p>* Add 50/50 mixture to Full Hot mark in coolant recovery reservoir or to the Full Cold mark for a cold engine.</p> <p>For air conditioning refrigerant information, see your dealer.</p>		

Motorcraft Parts

Component	Ford Part Number	
	1.8L MFI DOHC Engine	1.9L SFI Engine
Air filter	FA-1072	FA-1031
Battery	BXT-35	BX-35
Crankcase emission filter	—	FA-1067
Fuel filter	FG-800A	FG-800A
Oil filter	FL-816	FL-400A
PCV Valve	EV-150	EV-160
Spark plug*	AGSP-32C	AGSF-34EE

* Refer to Vehicle Emission Information (VECI) decal, located on the underside of the hood, for gap specifications.

If an original 1.9L engine spark plug is removed for examination, it must be reinstalled in the same cylinder. Spark plugs in cylinders 1 and 3 have a EG suffix. Spark plugs in cylinders 2 and 4 have a E suffix. If a spark plug needs to be replaced, use only spark plugs with the service part number suffix EE as shown on the engine decal.

Item	Ford Part Name	Ford Part Number	Ford Specification
Brake Master Cylinder	Ford High Performance DOT 3 Brake Fluid	C6AZ-19542-AA	ESA-M6C25-A
Constant Velocity Joints	CV Joint Grease - High Temperature	E43Z-19590-A	ESP-M1C207-A
Door Weatherstrips	Silicone Lubricant	C0AZ-19553-AA	ESR-M13P4-A
Engine Coolant	Ford Premium Cooling System Fluid	E2FZ-19549-AA	ESE-M97B44-A
Engine Oil	Motorcraft 5W30 Super Premium	XO-5W30-QSP	EPI-M2C153-E and API Certification Mark

Item	Ford Part Name	Ford Part No.	Ford Specification
Hinges and Latches	Ford Multi-Purpose Grease Spray	D7AZ-19584-AA	ESR-M1C159-A and ESB-M1C06B
Lock Cylinders	Penetrating Lubricant	E8AZ-19A501-B	N/A
Power Steering Pump	Motorcraft Ford Type "F" Automatic Transmission and Power Steering Fluid	XT-1-QF	ESW-M2C33-F
Transaxle Automatic	Motorcraft MERCON® and DEXRON® IIE Automatic Transmission Fluid	XT-2-QDX	MERCON®
Manual	Motorcraft MERCON® and DEXRON® IIE	XT-2-QDX	MERCON®
Wheel Bearings, Rear	Motorcraft Premium Long-Life Grease	XG-1-C	ESA-M1C75-B
Windshield Washer Reservoir	Ultra-Clear Windshield Washer Concentrate	C9AZ-19550-AA or C9AZ-19550-BA	ESR-M17P5-A

Vehicle Storage

Maintenance Tips

If you plan on storing your vehicle for an extended period of time (60 days or more), refer to the following maintenance recommendations to ensure your vehicle stays in good operating condition.

General

- Store all vehicles in a dry, ventilated place.
- Protect from sunlight, if possible.
- If vehicles are stored outside, they require regular maintenance to protect against rust and damage.

Body

- Wash vehicle thoroughly to remove dirt, grease, oil, tar or mud from exterior surfaces, rear wheel housing and underside of front fenders.
- Periodically wash vehicles stored in exposed locations.
- Touch-up raw or primed metal to prevent rust.
- Cover chrome and stainless steel parts with a thick coat of auto wax to prevent discoloration. Re-wax as necessary when the vehicle is washed.
- Lubricate all hood, door and trunk lid hinges and latches with a light grade oil.
- Cover interior soft trim to prevent fading.
- Keep all rubber parts free from oil and solvents.

Engine

- Start engine every 15 days. Run at fast idle until it reaches normal operating temperature.
- With your foot on the brake, shift through all the gears while the engine is running.

Fuel system

- Fill fuel tank with high-quality unleaded fuel until the first automatic shutoff of the fuel pump nozzle.

NOTE: During extended periods of vehicle storage (60 days or more), fuel may deteriorate due to oxidation. This can damage rubber and other polymers in the fuel system and may also clog small orifices.

Ford Gas Stabilizer should be added whenever actual or expected storage periods exceed 60 days. Follow the instructions on the label. The vehicle should then be operated at idle speed to circulate the additive throughout the fuel system.

A volatile corrosion inhibitor added to the fuel system will protect the fuel system's inner surfaces from corrosion. Follow the instructions packaged with the product.

Cooling system

- Protect against freezing temperatures.

Battery

- Check and recharge as necessary.
- Keep connections clean and covered with a light coat of grease.

Brakes

- Make sure brakes and parking brake are fully released.

Tires

- Maintain recommended air pressure.

Miscellaneous

- Make sure all linkages, cables, levers and clevis pins under vehicle are covered with grease to prevent rust.
- Move vehicles at least 25 feet (8 m) every 15 days to lubricate working parts and prevent corrosion.

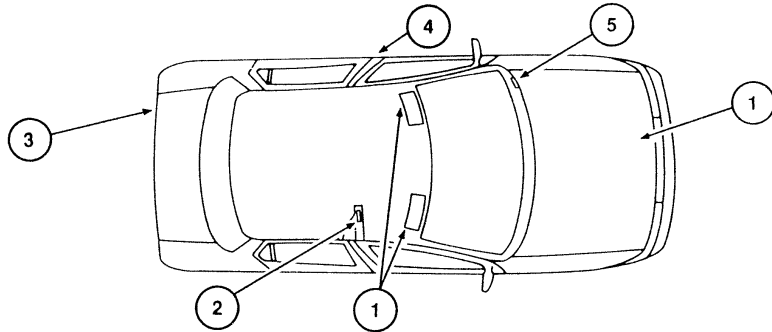

No.	Description	Refer to this label for information regarding:
1	Air Bag Warning Labels	Air bag precautions
2	Child Seat Label	Child seat installation precautions
3	Fuel Pump Shut Off Label	Fuel pump shut off location
4	Safety Compliance Certification Label	Name and date of manufacturer, GVWR*, GAWR**, wheel and tire information
5	Vehicle Identification Number (VIN) Label	Servicing or warranty information specific to your vehicle

* Gross Vehicle Weight Rating

** Gross Axle Weight Rating



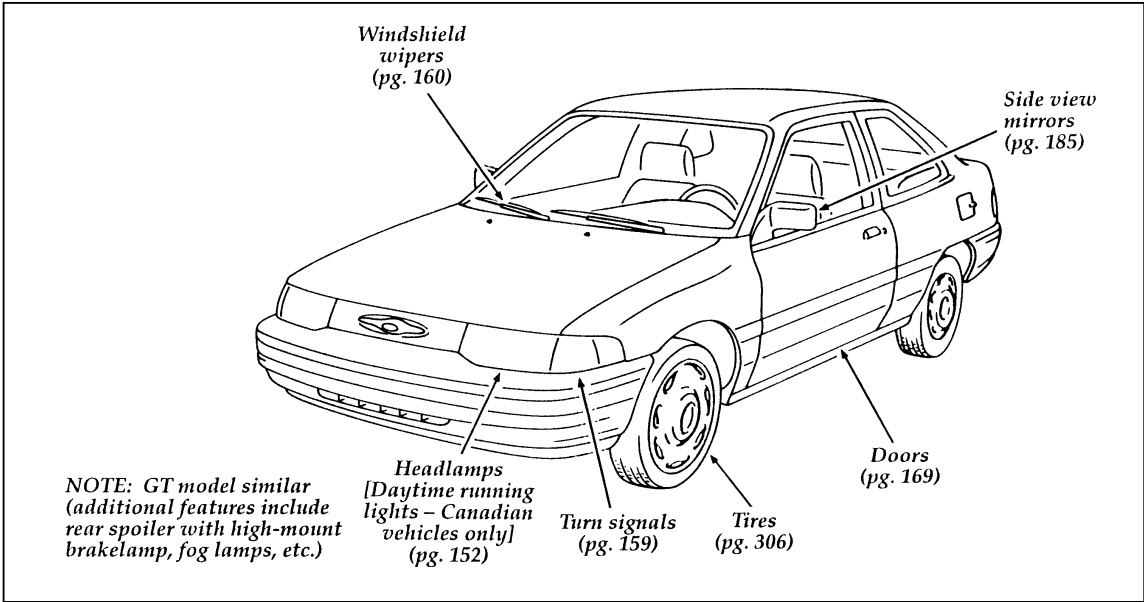

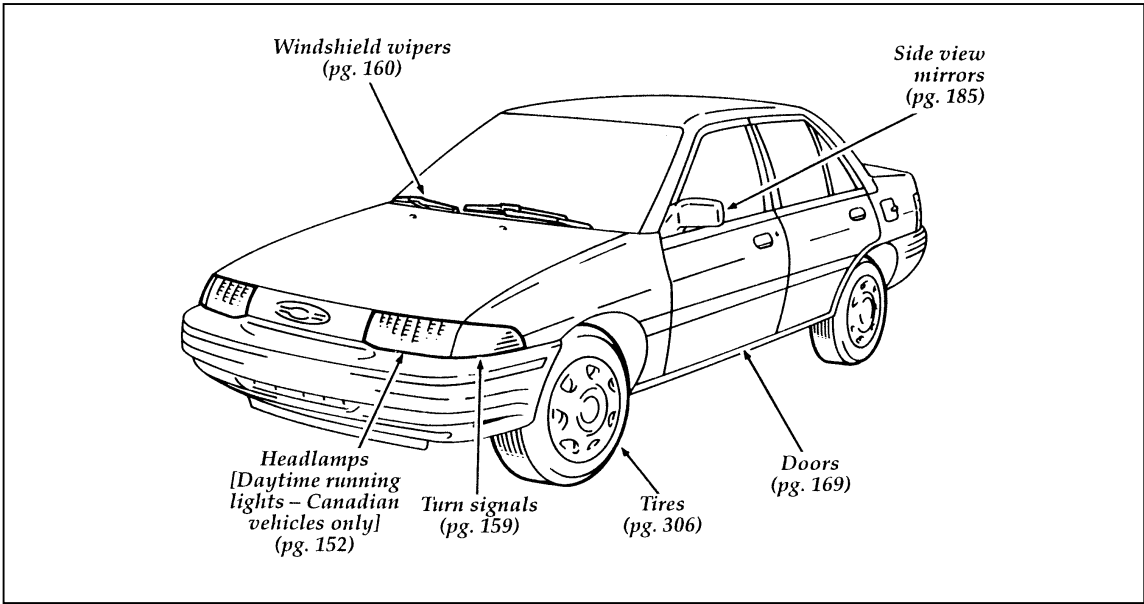

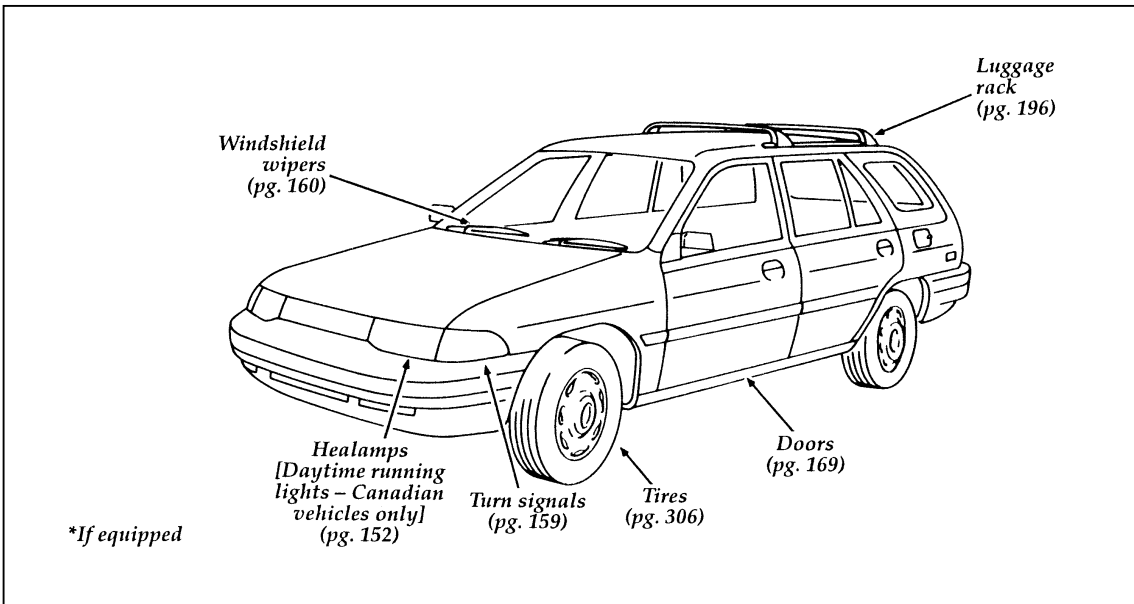

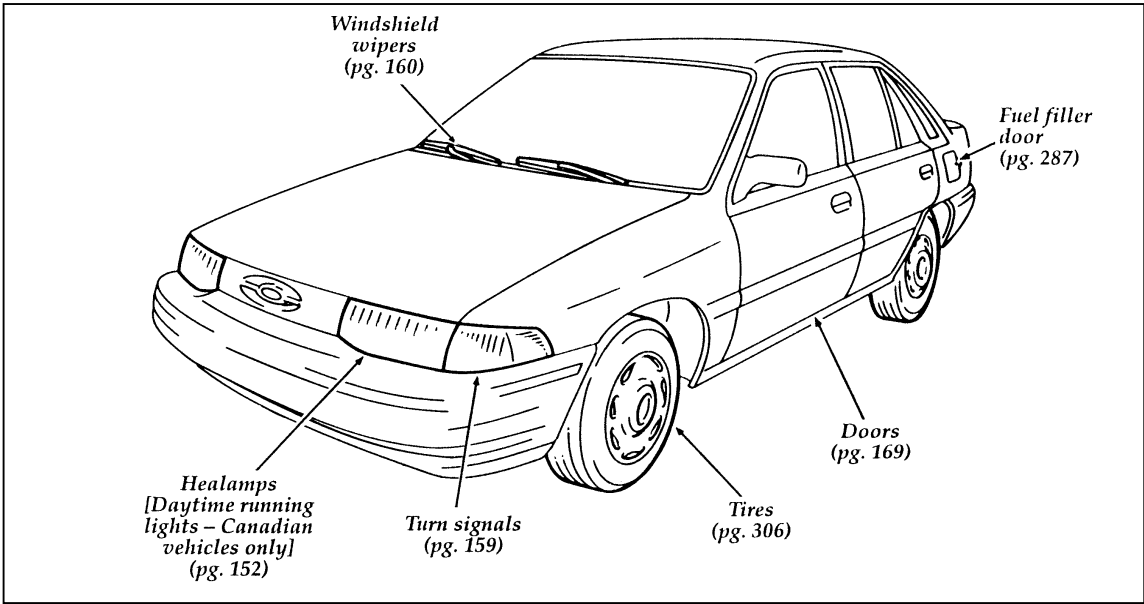

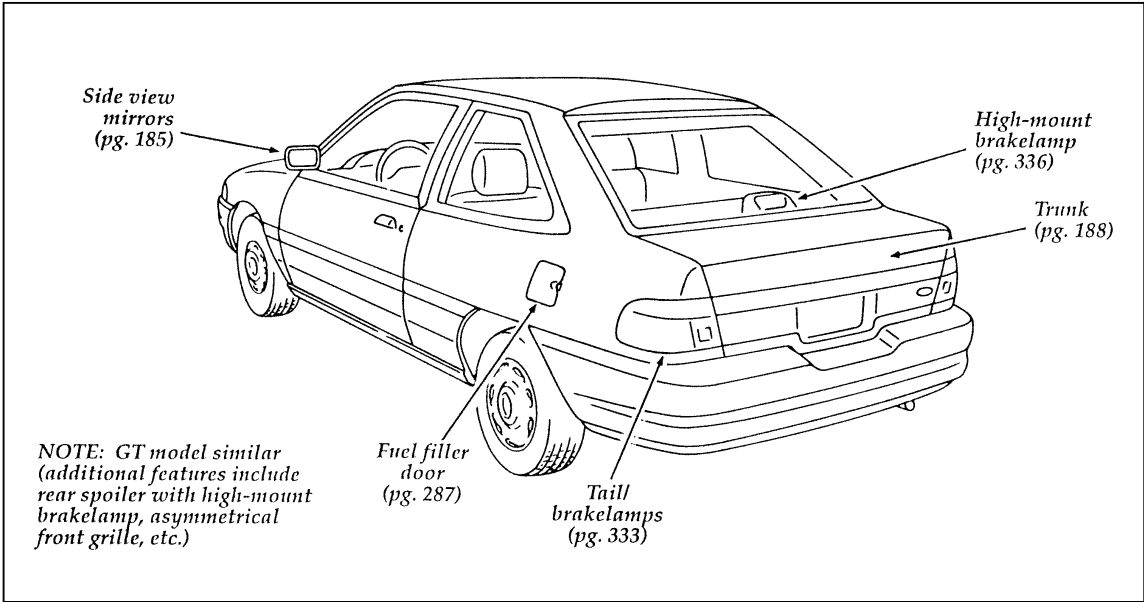

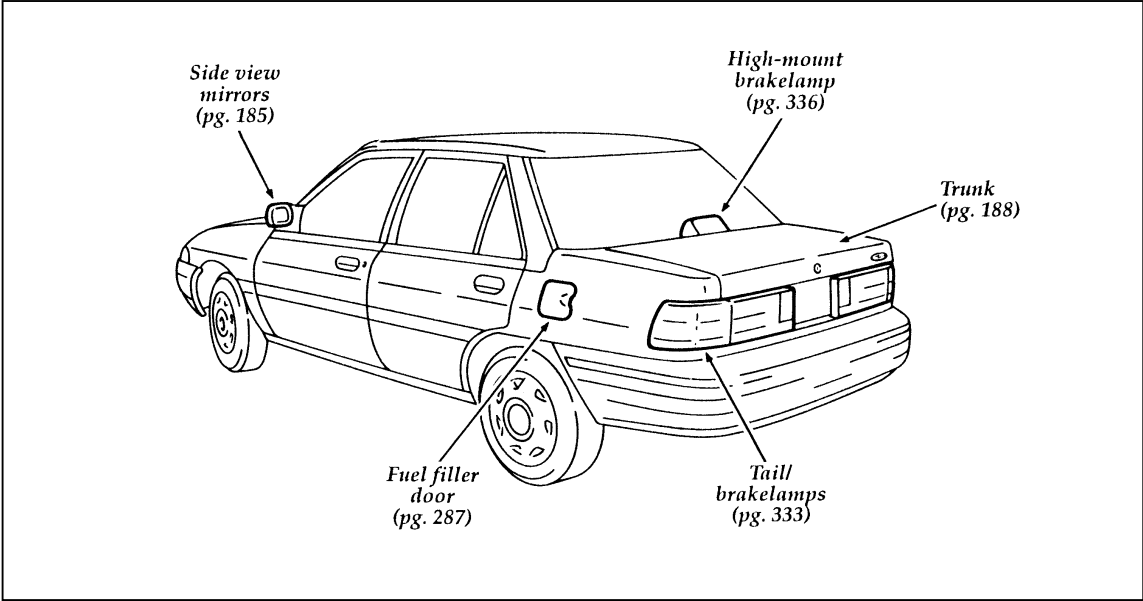

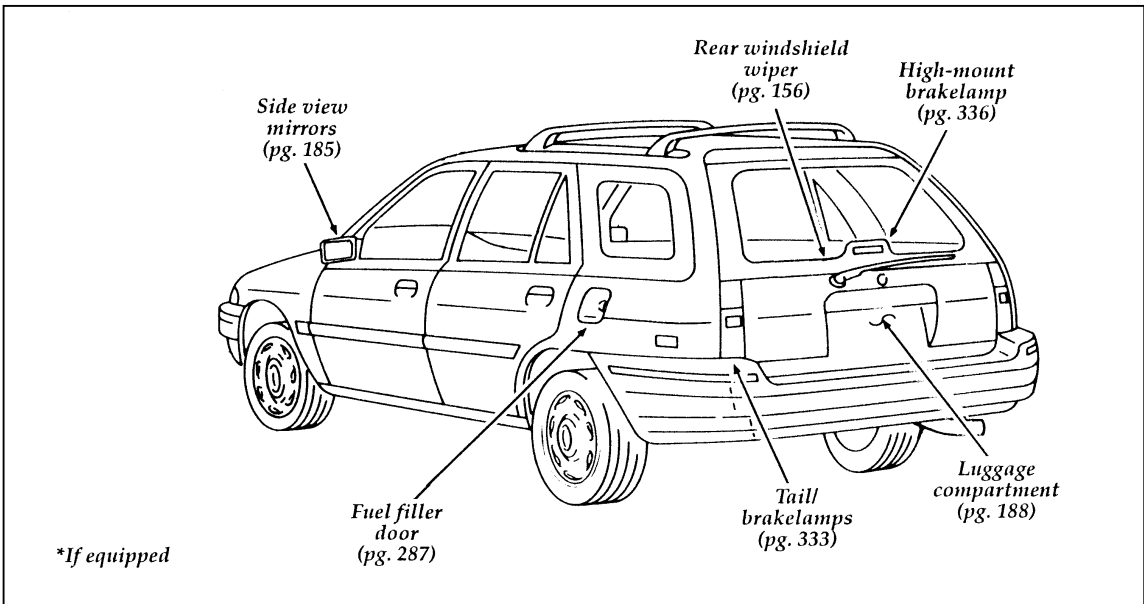

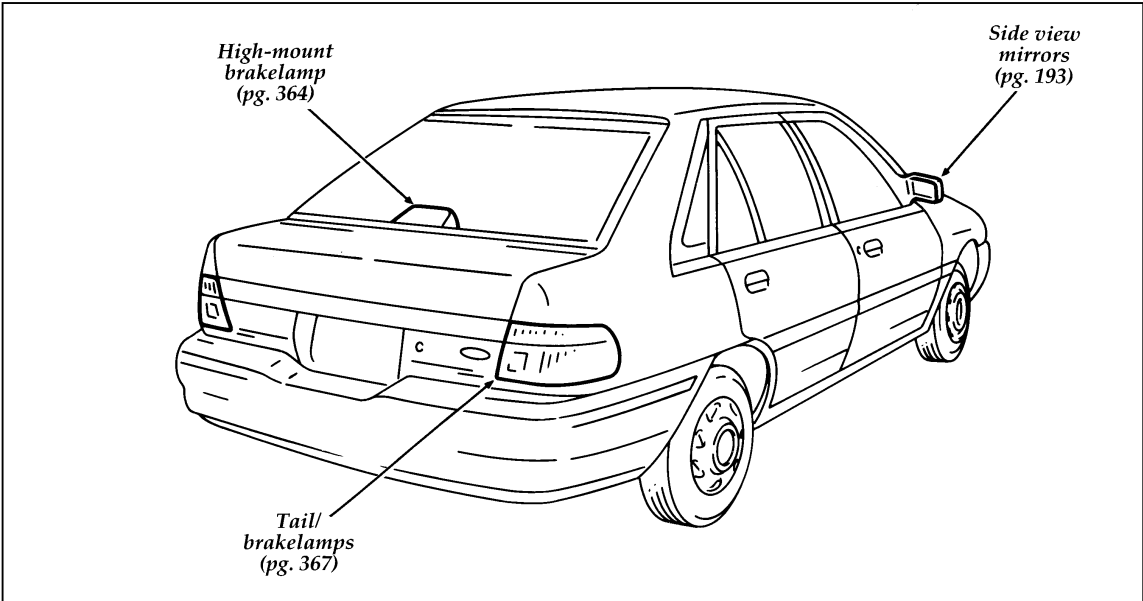

Q U I C K - I N D E X

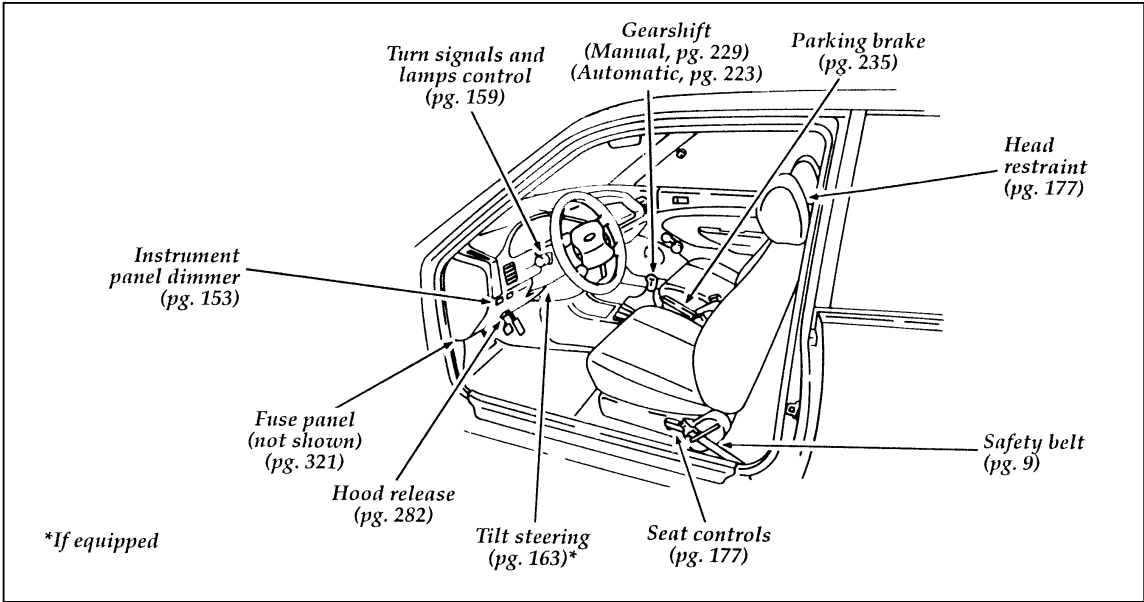

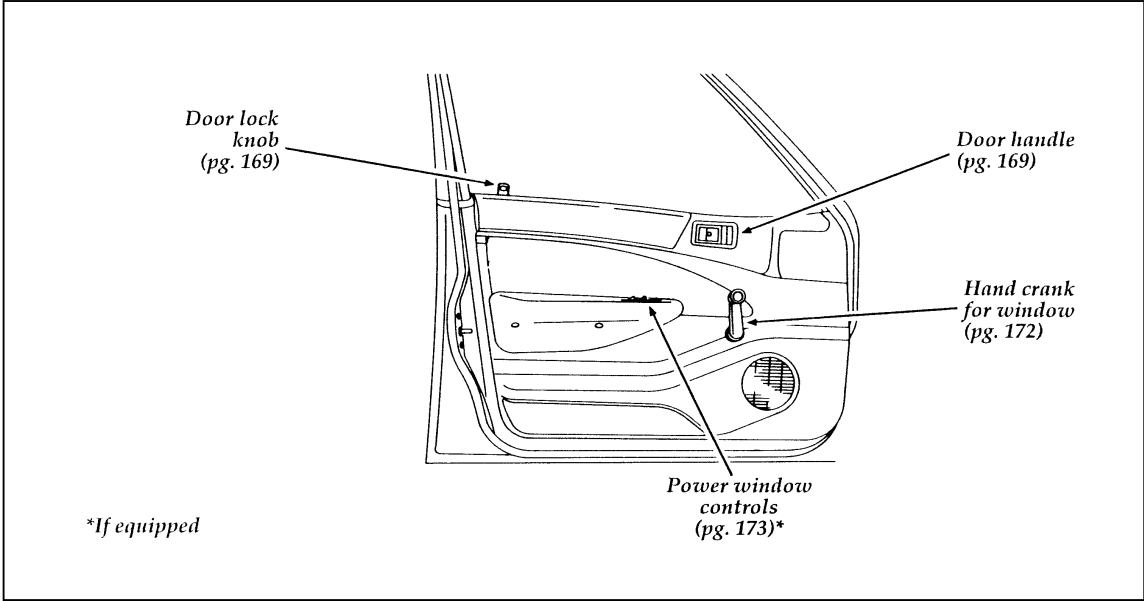

Instrument Panel

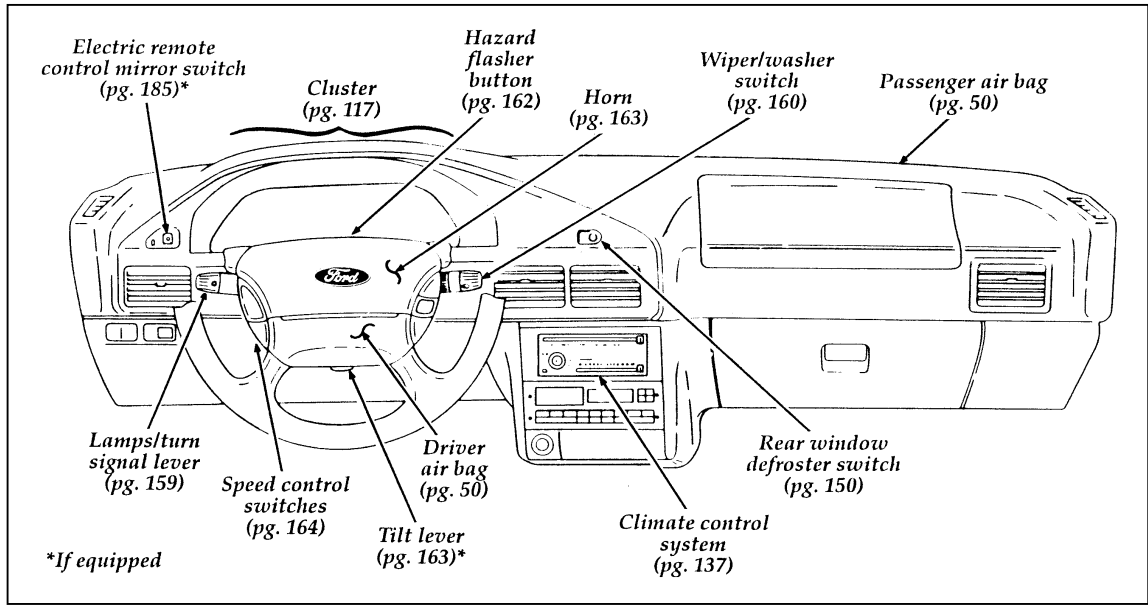

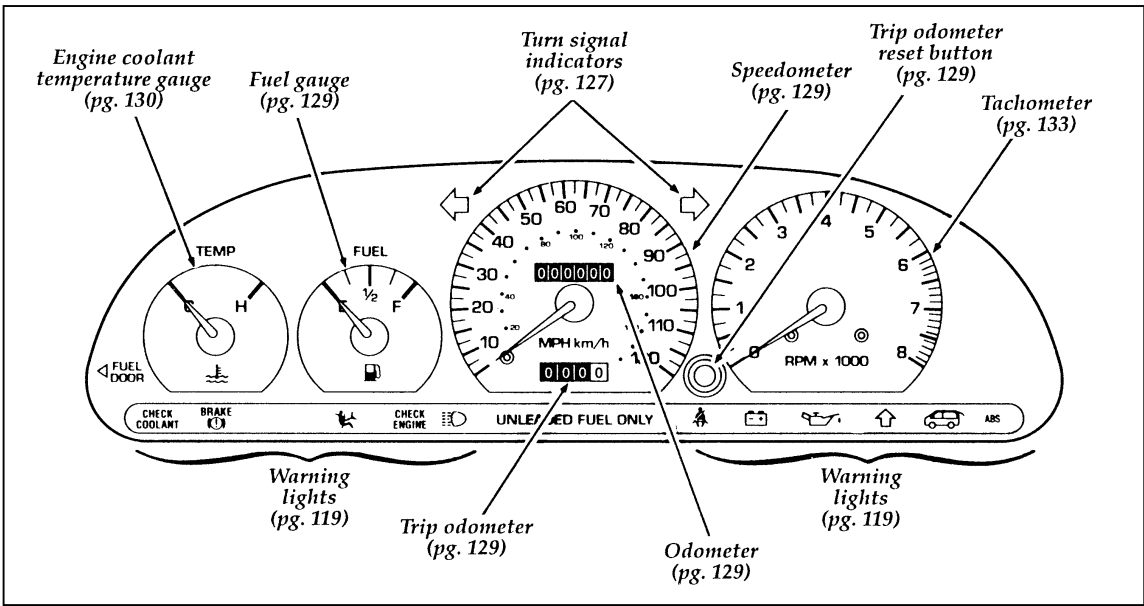

Instrument Cluster

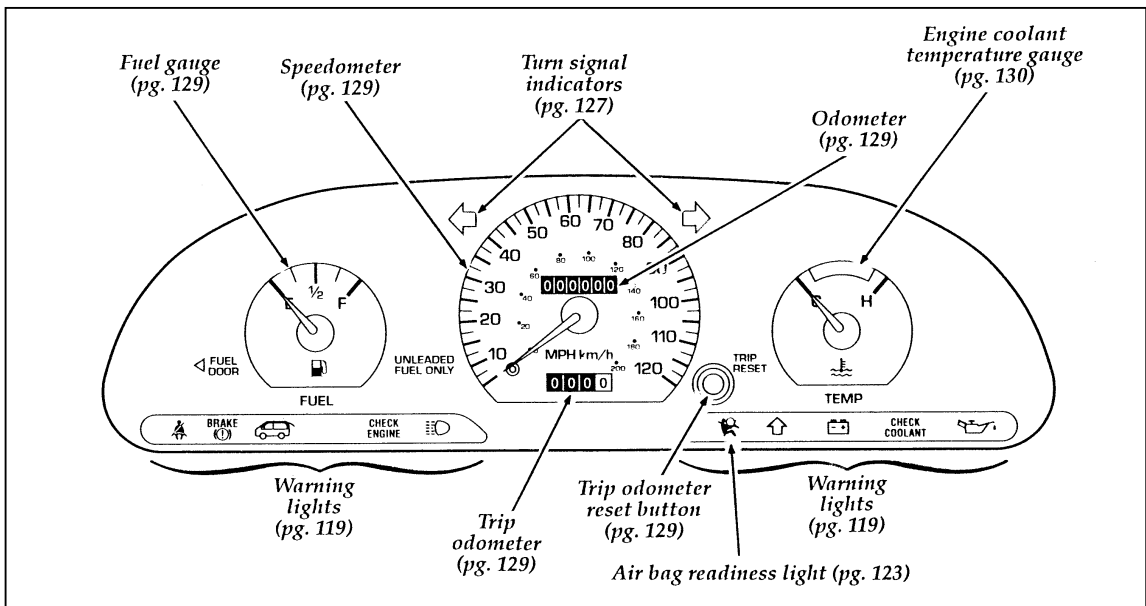

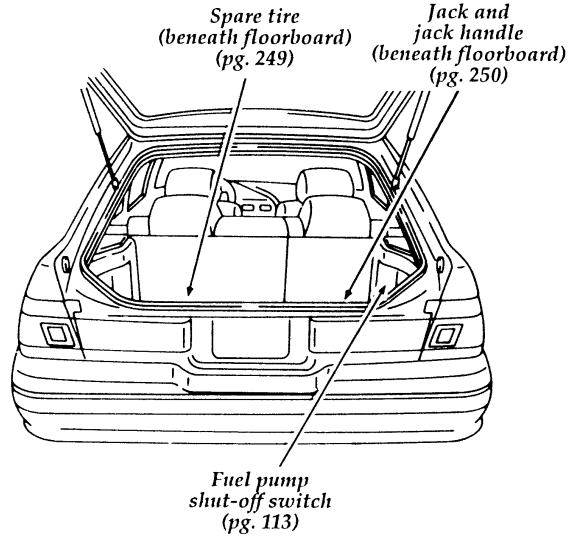

NOTE: Trunk similar



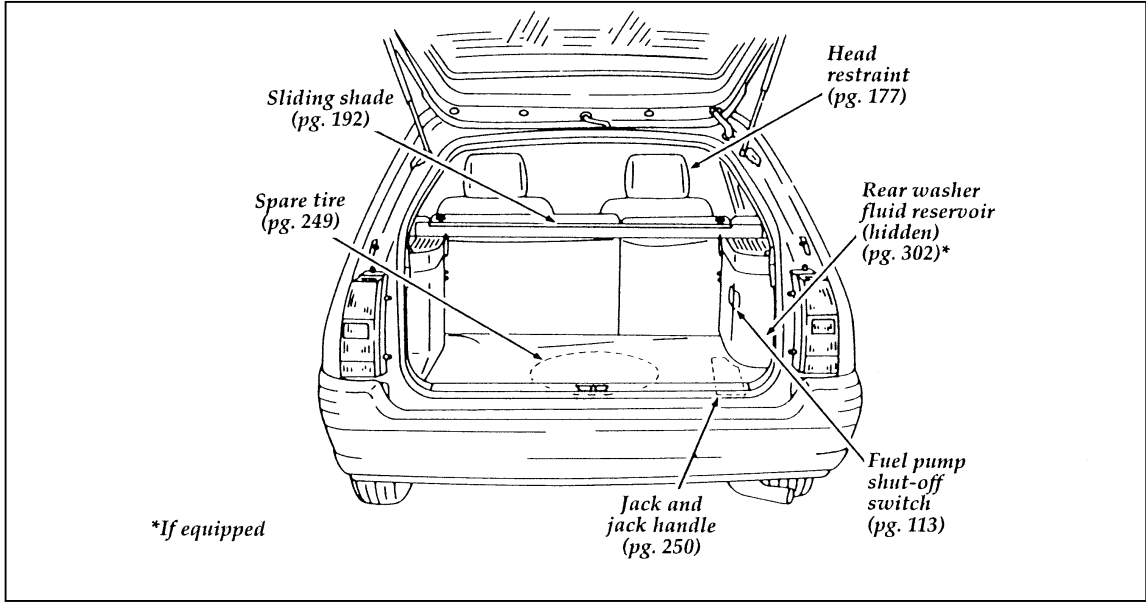

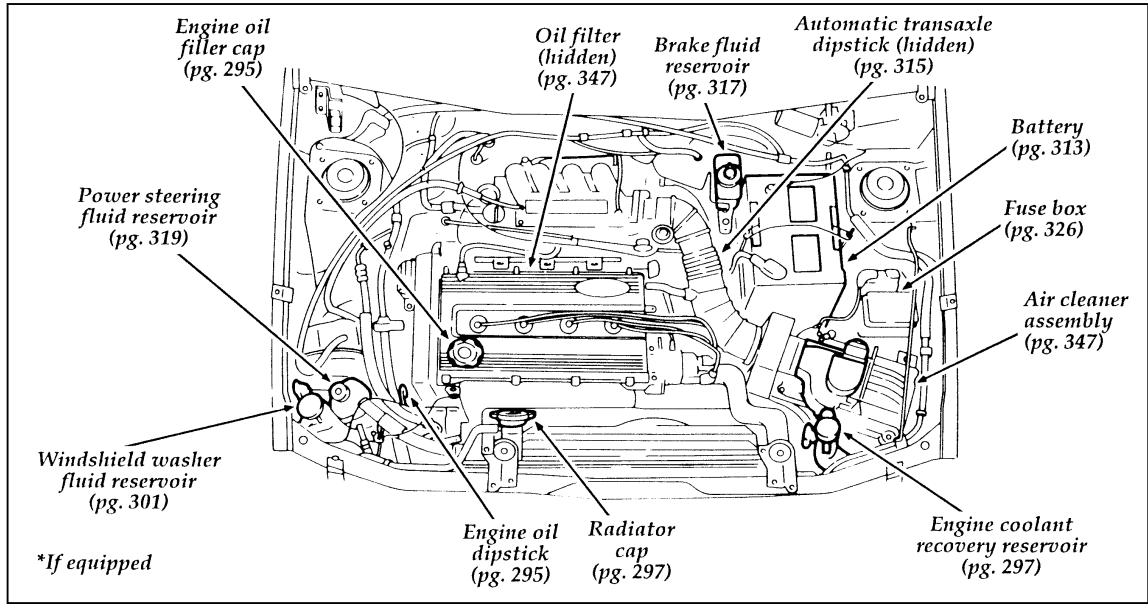

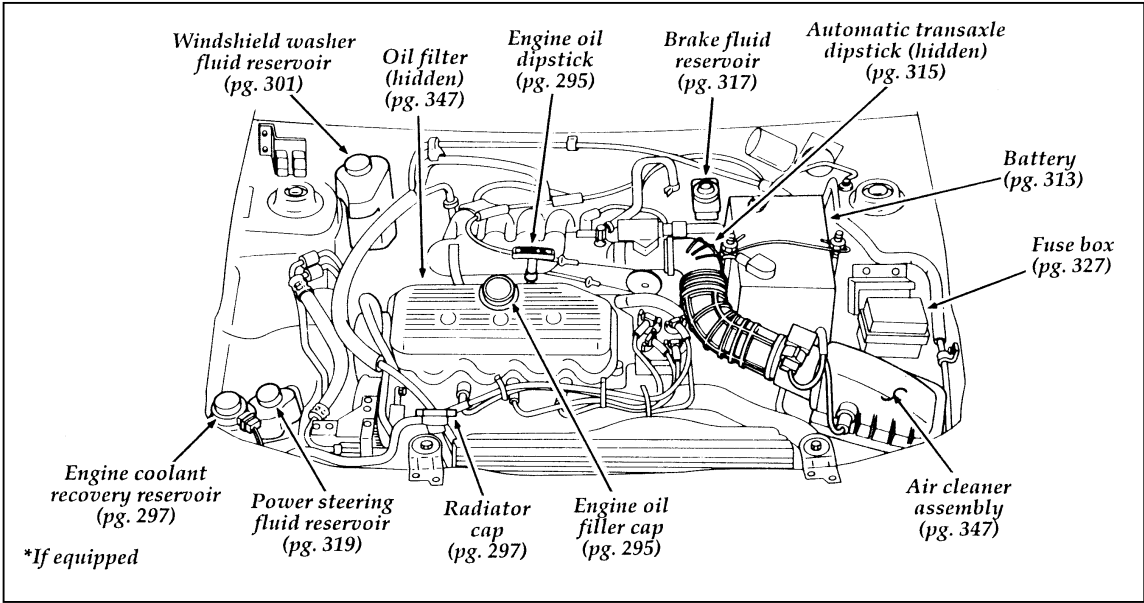

Index

A

ABS warning light (see Anti-lock brake system)	127
Accessory position on the ignition	106
Additives, engine oil	294
Air bag Supplemental Restraint System	
and child safety seats	52
description	50
disposal	57
driver air bag	50
indicator light	123
operation	53
passenger air bag	50
proper seating	51
service and information labels	57
tone generator	56
wearing safety belts.	50
Air cleaner filter	
location	285
specifications	347
Antenna, radio (see Electronic sound system)	157, 220
Antifreeze (see Engine coolant)	297
Anti-lock brake system (ABS)	
description	233
warning light.	127
Anti-theft lug nuts and key	255
Assistance (see Customer assistance)	259
Audio system (see Electronic sound system)	197
Autolamp system (see Headlamps)	152

Automatic transaxle	
driving with	223
fluid, adding	315
fluid, checking	315
fluid, refill capacities	345
fluid, specification.	348

B

Backing up	229
Basic vehicle warranty	4
Battery	313
acid, treating emergencies	243
charging system warning light	121
disconnecting	248
how to service	313
jumping a disabled battery.	243
maintenance-free	313
proper disposal, recycling	314
replacement, specifications	347
servicing	313
when storing your vehicle	352
Brake fluid	
checking and adding	317
description	317
specifications	318, 348
Brakes	
anti-lock	233
anti-lock brake system (ABS)	
warning light.	127
applying the brakes	232
fluid, checking and adding.	317
fluid, specifications	348
new brake linings.	5
noise.	233
parking	235
servicing	317
stopping distances.	238
when storing your vehicle	352
Break-in period	5
Brights (high beams).	160

Bulbs, replacing	333
halogen	334
headlamps	334

C

Canada, customer assistance	267
Canada, warranty information	4
Canadian Motor Vehicle Arbitration Plan (CAMVAP).	268
Capacities for refilling fluids	345
Carbon monoxide in exhaust.	115
Car seats for children (see Child safety seats)	60
Cassette tape player (see Electronic sound system)	212, 217
Catalytic converter	340
CD player (see Electronic sound system)	204
Chains, tires	311
Changing a tire	249
Charging system warning light.	121
Child safety restraints	58
Child safety seats	60
and air bags	52, 60
automatic locking mode (retractor)	68
in front seat	68
in rear outboard seat	80
in rear seat.	80
Circuit breakers checking and replacing	332
Cleaning your vehicle	
CD player and discs	208
chrome and aluminum parts.	7
engine compartment	287
exterior	6
exterior lamps	153
fabric	183
headlamps	153
instrument panel	7, 137

Cleaning your vehicle (continued)	
instrument panel lens	158
interior	183
interior lamps.	155
plastic parts	7
polishing	6
rustproofing	7
safety belts	50
tail lamps	153
upholstery and interior trim	183
washing	6
waxing.	6
wheels	312
Climate control system.	137
Clock.	203, 218
Clutch	
fluid reservoir	317
fluid specifications	349
operation while driving	229
shifting the gears	229
Cold engine starting	110
Combination lap and shoulder belts.	9
Compact disc player	
(see Electronic sound system)	198, 204
Controls	
instrument panel	135
mirrors.	184
steering column.	159
Convenience kit in cargo area	250
Coolant (see Engine coolant)	
checking and adding	297
preparing for storage	351
refill capacities	345
specifications	348
temperature gauge	130
warnings	297
Cooling fan	280
Crankcase emission filter.	347
Cruise control (see Speed control).	164

Customer Assistance Center, Ford (U.S.)	262
Customer Assistance Centre, Ford of Canada.	262, 267

D

Dashboard (see Instrument panel)	135
Daytime running light system	152
Dipstick	
automatic transaxle fluid	315
engine oil	295
power steering fluid	319
Disabled vehicle (see Towing)	257
Doors	169
lubricant specifications	348
Driving under special conditions	
bad weather	238
heavy load	240
high water	239
slippery roads	238
tips for safe driving.	237
towing a trailer.	241

E

Electrical system	
circuit breakers	332
fuses	320
Electronic radio with cassette (see Electronic sound system)	213
Electronic sound system	
antenna	157
radio reception	220
tuning the radio	199, 214
warranty and service information	222
Electronic stereo cassette radio (see Electronic sound system)	213

Emergencies, roadside	
assistance	259
battery acid spills	243
fuel	291
jump-starting	243
towing	257
Emergency brake (parking brake)	235
Emission control system	
catalytic converter	340
emissions warranty	4, 340
Engine	
check engine warning light	124
does not start	111, 113
fuel injected engine, starting	108
fuel pump shut-off switch	113
preparing to start	108
refill capacities	345
service points	284
starting	105
starting after a collision	113
storing your vehicle	350
Engine block heater	112
Engine coolant	
checking and adding	297
checking hoses	301
disposal	280, 300, 317
preparing for storage	351
recovery reservoir	297
refill capacities	345
specifications	348
temperature gauge	130
Engine coolant temperature gauge	
description	130
Engine fan	280
Engine oil	
checking and adding	295
dipstick	295
disposal	280, 300, 317
engine oil pressure warning light	128
filter, specifications	347

Engine oil (continued)	
refill capacities	345
specifications	294, 348
synthetic oil	294
“break-in” oils	5
viscosity	294
Exhaust fumes	115
Extended Service Plan, Ford	4

F

Fan	
engine fan, avoiding injury	280
Flashers, hazard.	162
Flat tire	249
Fluid refill capacities	345
Ford Customer Assistance Center.	262
Ford Extended Service Plan	4
Ford Motor Company of Canada	267
Ford of Canada Customer Assistance Centre.	267
Foreign registration	269
French owner guides, how to obtain	3
Fuel	
calculating fuel economy	292
capacity	345
comparisons with EPA fuel economy estimates	293
filling your vehicle with fuel.	287
filter, specifications	347
fuel filler door release lever	287
fuel gauge	129
improving fuel economy	293
octane rating	289
running out of fuel	292
safety information relating to automotive fuels	291
storing your vehicle.	351
treating emergencies	291

Fuel cap	
removing	287
replacing	288
Fuel filler door	
remote release	287
Fuel filter, specifications	347
Fuel gauge	129
Fuel pump shut-off switch	
engine does not start	113
starting after a collision	113
Fuses	
checking and replacing	320
circuit breakers	332

G

Gas cap (see Fuel cap)	287
Gas mileage (see Fuel economy)	292
Gasoline (see Fuel).	287
Gauges	
engine coolant temperature gauge	130
fuel gauge	129
odometer.	129
speedometer	129
tachometer	133
trip odometer.	129
GAWR (Gross Axle Weight Rating)	
calculating	241
definition.	240
driving with a heavy load	240
location	240
Gearshift	
automatic operation	223
downshifting	231
locking the gearshift.	105
positions	224, 229
shifting the gears	224, 229
GVWR (Gross Vehicle Weight Rating)	
calculating	241
definition.	240
driving with a heavy load	240

GVWR (Gross Vehicle Weight Rating) (continued)	
location	240

H

Hazard flashers	162
Headlamps	
aiming	333
checking alignment	333
cleaning	153
daytime running lights	152
replacing bulbs	333
turning on and off	151
Head restraints	177
High beams	
indicator light	122
operation	151
Hood	
latch location	282
lubrication specifications	348
release lever	282
working under the hood	280
Horn	163
Hoses, checking	301

I

Identification Number, Vehicle (VIN)	267
Idle, relearning	248, 280
Ignition	
positions of the ignition	105
removing the key	107
Indicator lights and chimes (see Lights)	119
Infant seats (see Safety seats)	58
Instrument cluster	117
Instrument panel	
cleaning	158
lighting up panel and interior	153
location of components	135

J

Jack

operation	251
positioning	251
storage	250

Jump-starting your vehicle

attaching cables	243
disconnecting cables	248

K

Keys

positions of the ignition	105
removing from the ignition	107
stuck in lock position	105, 107

L

Lamps

checking	333
daytime running light system	152
dome lamps	154
hazard flashers	162
headlamps	151
instrument panel, dimming	153
interior lamps.	153
replacing bulbs	333

Lane change indicator (see Turn signal) . .	159
---	-----

Lights, warning and indicator

air bag	123
anti-lock brakes (ABS)	127
charging system.	121
check engine	124
engine oil pressure	128
hazard warning light	162
high beam	122
turn signal indicator.	127, 159

Load limits

GAWR	240
GVWR	240
trailer towing	241

Lubricant specifications	348
Lug nuts	
anti-theft	255
standard	251
tightening sequence	254

M

Maintenance schedule and record (see separate Maintenance Schedule and Record booklet)	3
Maintenance (see Servicing)	279
Manual transaxle	
backing up (reverse)	229
clutch	229
shifting gears	229
Master cylinder, brakes	317
Methanol in fuel	290
Mileage, calculating fuel economy	292
Mirrors	
rearview	184
side view mirrors	184
side view mirrors (manual)	185
Moon roof	174
Motorcraft parts	347

N

New vehicle break-in	5
--------------------------------	---

O

Octane rating	289
Odometer	
description	129
trip odometer	129
Oil filter	347
Oil (see Engine oil)	294
Oil viscosity	294
On-board diagnostic (OBD II) system	343
Order forms, service information	275

Overdrive	226
Overseas offices	269

P

Parking brake	
operation	235
Parts (see Motorcraft Parts)	347
PCV valve, specifications	347
Power door locks	170
Power features	
door locks	170
mirrors	184
moon roof	174
windows	172
Power steering	
dipstick	319
driving with power steering	232
fluid, checking and adding	319
fluid, refill capacity	345
fluid, specifications	348
Prop rod, hood	282

R

Radio (see Electronic sound systems)	197
Rear axle	
lubricant specification	349
Rear window	172
washer reservoir	301
Refill capacities for fluids	345
Restraints, safety (see Safety restraints)	
adult	9
child	58
head	177
infant	58
Roadside assistance	259
Roadside emergencies	243
Rotating the tires	307

S

Safe driving tips	237
Safety belts (see Safety restraints).	9
Safety Compliance Certification Label	240
Safety information relating to automotive fuels	291
Safety restraints automatic locking mode (retractor)	25, 30, 34
cleaning the safety belts	50
extension assembly	49
for adults	9
for children	58
for infants	59
head.	177
lap and shoulder belts	9
maintenance	49
proper use	9
replacement	49
untwisting or unjamming the safety belt	41
Safety seats for children and air bags	52
automatic locking mode (retractor)	25
in center rear seat	86
in front seat	68
in front seat (Canadian 2-door vehicles).	63
in rear outboard seat	80
Seat belts (see Safety restraints).	9
Seats.	177
child safety seats	60
cleaning upholstery	183
head restraints	177
Serial number (VIN).	267
Service concerns	260
Servicing your vehicle precautions when servicing	280
servicing when you tow.	257

Shift positions (see Gearshift)	224, 229
Shoulder and lap belts (see Safety restraints)	9
Side mirrors	185
adjusting	185
Sliding moon roof (see Moon roof)	174
Snow tires and chains	311
Spare tire	
changing the tire	249
conventional spare	250
finding the spare	250
removing the spare tire	250
storing the flat tire	250
temporary spare	249
Spark plugs, specifications	347
Special driving conditions	237
Specification chart, lubricants	348
Speedometer	129
Starting your vehicle	
preparing to start your vehicle	108
starting a cold engine	110
starting after a collision	113
starting a warm engine	110
starting your vehicle if the battery is disabled	243
Steering, power	232
Steering wheel	
horn	163
locking	105
speed controls	164
Storing your vehicle	350
Sunroof (moon roof)	174
Supplemental air bag readiness light	123
Supplemental Restraint System (SRS)	50

T

Tachometer	133
Tail lamps	
bulb replacement	333
cleaning	153
Temperature control (see Climate control)	137
Tires	
changing.	249
checking the pressure	306
cleaning	312
inspection and maintenance	306
replacing.	308
rotating	307
snow tires and chains	311
spare tire	250
storing your vehicle.	352
tire grades	308
treadwear	308, 310
wear bands	308
wheel and tire matching.	309
Towing a trailer (see Trailer towing)	241
Towing your vehicle	
using wheel dollies	257
with a tow truck	257
Trailer towing	
calculating maximum trailer weight . . .	241
Transaxle	
automatic operation.	223
fluid, checking and adding (automatic)	315
fluid, refill capacities	345
lubricant specifications	349
Transaxle control switch	226
Trip odometer	129
Tune-up specifications (VECI)	342
Turn signal	
indicator lights	127, 159
lever	159

U

Used engine oil, disposal 280, 300, 317

V

VECI (Vehicle Emission Control Information) decal 342
Vehicle Identification Number (VIN) 267
Vehicle loading
 calculating the load 241
 understanding loading information 240
Vehicle storage 350
Ventilating your vehicle
 (see Climate control) 137
Viscosity (see Engine oil). 294

W

Warm engine, starting 110
Warning lights (see Lights). 117, 135
Warranties
 basic 4
 Canada 4
 radio 222
Warranty Information Booklet 4
Washer fluid
 rear window reservoir 302
 reservoir 301
 windshield 301
Weight limits (GAWR, GVWR) 240
Wheel and tire matching 309
Wheel bearings, lubricant specifications 349
Wheel dollies (see Towing). 257

Wheels	
anti-theft lugnuts	255
cleaning	312
covers	251
inspection and maintenance	306
lug nuts	251
replacement	309
Windows	
manual windows, operating	172
power windows, operating	173
Windshield washer fluid and wipers	
checking and adding fluid.	301
checking and replacing wiper blades	302
liftgate reservoir	302
reservoir	301
specifications	301, 349
Wrecker towing.	257

Service Station Information

Engine	1.8 Liter	16V (4 valves per cylinder), DOHC (Dual Overhead Cam), MFI (Multiport Fuel Injection), 4 Cylinder, 112.2 Cubic Inch Displacement (CID)
	1.9 Liter	8V (2 valves per cylinder), SFI (Sequential Multiport Fuel Injection), 4 Cylinder, 116 Cubic Inch Displacement (CID)
Fuel		UNLEADED FUEL ONLY — Octane 87
Fuel Tank Capacity	1.8 Liter	13.2 gallons (50 liters)
	1.9 Liter	11.9 gallons (45 liters)
Engine Oil		Use engine oil displaying American Petroleum Institute Certification Mark. SAE 5W30 is preferred.
Engine Oil Capacity		4.0 quarts (3.8 liters) with filter change
Engine Coolant Capacity		Manual Transaxle: 5.3 quarts (5.0 liters) Automatic Transaxle: 6.3 quarts (6.0 liters)
Tire Size & Pressure		See the Tire Pressure Decal on the passenger's door pillar.
Brake Fluid		Use only brake fluid that meets Ford's Specification ESA-M6C25-A.
Power Steering Fluid		Use only power steering fluid that meets Ford's Specification ESW-M2C33-F.
Automatic Transaxle Fluid		Motorcraft MERCON® (ATF)
Hood Release		Pull the handle under the left side of the instrument panel.