

2024 FORD RANGER Owner's manual

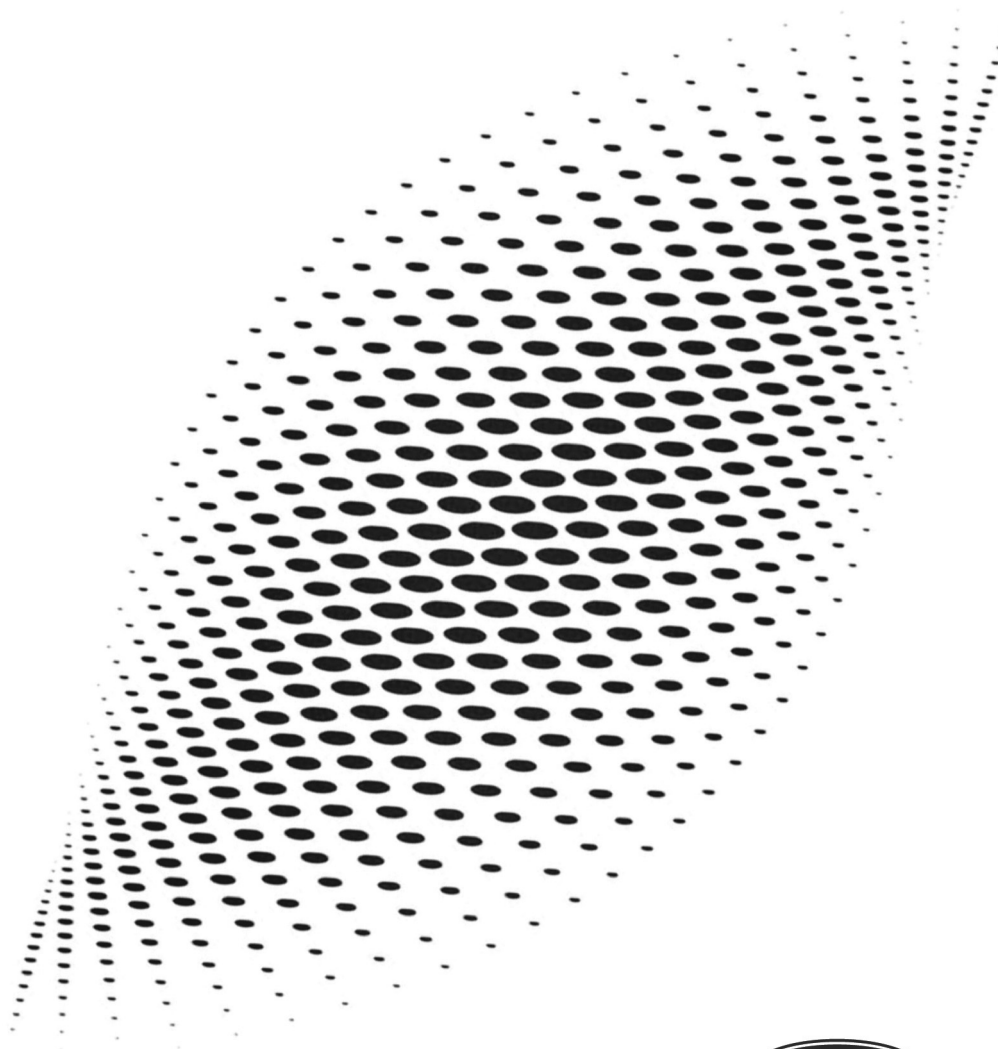

The information contained in this publication was correct at the time of release. In the interest of continuous development, we reserve the right to change specifications, design or equipment at any time without notice or obligation. No part of this publication may be reproduced, transmitted, stored in a retrieval system or translated into any language in any form by any means without our written permission. Errors and omissions excepted.

© Ford Motor Company 2023

All rights reserved.

Part Number: -202304-20230421165424

California Proposition 65



WARNING: Operating, servicing and maintaining a passenger vehicle or off-highway motor vehicle can expose you to chemicals including engine exhaust, carbon monoxide, phthalates, and lead, which are known to the State of California to cause cancer and birth defects or other reproductive harm. To minimize exposure, avoid breathing exhaust, do not idle the engine except as necessary, service your vehicle in a well-ventilated area and wear gloves or wash your hands frequently when servicing your vehicle. For more information go to www.P65Warnings.ca.gov/passenger-vehicle.



WARNING: Battery posts, terminals and related accessories contain lead and lead compounds, chemicals known to the State of California to cause cancer and reproductive harm.
Wash your hands after handling.

Table of Contents

About Us

SVT	17
Team RS	17
Ford Performance	17

Contacting Us

Contacting Us	18
---------------------	----

Introduction

About This Publication	20
Using This Publication	21

Symbols Glossary

Symbols Used on Your Vehicle	22
------------------------------------	----

Data Privacy

Data Privacy	25
Service Data	26
Event Data	26
Settings Data	27
Connected Vehicle Data	27
Mobile Device Data	28
Emergency Call System Data	28

Environment

Protecting the Environment	29
----------------------------------	----

Visual Search

Steering Wheel - Excluding: Raptor	30
Steering Wheel - Raptor	31
Instrument Panel - Excluding: Raptor	32
Instrument Panel - Raptor	33
Vehicle Interior - Excluding: Raptor	34
Vehicle Interior - Raptor	35
Front Exterior - Excluding: Raptor	36
Front Exterior - Raptor	37
Rear Exterior - Excluding: Raptor	38
Rear Exterior - Raptor	39

Unique Features - Raptor

Unique Features	40
-----------------------	----

Child Safety

Child Safety Precautions	41
Child Restraint Anchor Points	42
Child Restraints	43
Installing Child Restraints	44
Booster Seats	49
Child Safety Locks	51

Seatbelts

Seatbelt Precautions	52
Fastening and Unfastening the Seatbelts	53
Sensitive Locking Mode	54
Automatic Locking Mode	54
Adjusting the Seatbelts During Pregnancy	55
Adjusting the Seatbelt Height	55
Seatbelt Reminder	56
Checking the Seatbelts	58
Seatbelt Extensions	58

Personal Safety System™

What Is the Personal Safety System	59
How Does the Personal Safety System Work	59
Personal Safety System Components	59

Airbags

How Do the Front Airbags Work	60
How Do the Side Airbags Work	60
How Do the Knee Airbags Work	61
How Does the Safety Canopy™ Work	62
Airbag Precautions	62
Properly Adjusting the Driver and Front Passenger Seats	63

Table of Contents

Children and Airbags	64
Front Passenger Sensing System	64
Crash Sensors and Airbag Indicator	67
Disposing of Airbags	68

911 Assist

What Is 911 Assist	69
How Does 911 Assist Work	69
Emergency Call Requirements	69
Emergency Call Limitations	70

Keys and Remote Controls

Remote Control Limitations	71
Using the Remote Control	71
Opening and Closing the Flip Key	72
Removing the Key Blade	72
Sounding the Panic Alarm	72
Locating Your Vehicle	72
Changing the Remote Control Battery - Vehicles With: Push Button Start	73
Changing the Remote Control Battery - Vehicles With: Flip Key	74
Replacing a Lost Key or Remote Control	75
Programming the Remote Control - Vehicles With: Push Button Start	76
Programming the Remote Control - Vehicles With: Flip Key	77
Keys and Remote Controls Audible Warnings - Vehicles With: Push Button Start	77
Keys and Remote Controls Audible Warnings - Vehicles With: Flip Key	78
Keys and Remote Controls – Troubleshooting	78

Doors and Locks

Operating the Doors From Outside Your Vehicle	79
Operating the Doors From Inside Your Vehicle	79

Autounlock	80
Autolock	80
Mislock	80
Autorelock	81
Door Lock Indicators	81
Doors and Locks Audible Warnings	81
Doors and Locks – Troubleshooting	81

Keyless Entry

What Is Keyless Entry	83
Keyless Entry Limitations	83
Keyless Entry Settings	83
Using Keyless Entry	83
Keyless Entry – Troubleshooting	83

Tailgate

Tailgate Precautions	85
Opening the Tailgate	85
Locking and Unlocking the Tailgate	85
Tailgate Work Surface	85

Security

Passive Anti-Theft System	87
Anti-Theft Alarm System	87
Security – Troubleshooting	88

Steering Wheel

Adjusting the Steering Wheel	90
Locking the Steering Wheel - Vehicles Without: Push Button Start	90
Locking the Steering Wheel - Vehicles With: Push Button Start	90
Horn	90
Switching the Heated Steering Wheel On and Off	91

Wipers and Washers

Wipers	92
Autowipers	92

Table of Contents

Checking the Wiper Blades	93
Replacing the Front Wiper Blades	93
Washers	94
Wipers and Washers Videos	95
Wipers and Washers – Troubleshooting	95

Exterior Lighting

Exterior Lighting Control	96
Headlamps	96
Headlamps – Troubleshooting	97
Autolamps	97
Exterior Lamps	98
Exterior Zone Lighting	100
Automatic High Beam Control	101
Automatic High Beam Control – Troubleshooting	103
Adaptive Front Lighting	104

Interior Lighting

Switching All of the Interior Lamps On and Off	106
Switching the Front Interior Lamps On and Off	106
Switching the Rear Interior Lamps On and Off	106
Interior Lamp Function	106
Adjusting the Instrument Panel Lighting Brightness	107
Ambient Lighting	107
Interior Lighting – Troubleshooting	107

Windows

Opening and Closing the Windows	108
Global Opening and Closing	108
Window Bounce-Back	109
Locking the Rear Window Controls	110
Opening and Closing the Sliding Windows	110

Interior Mirror

Interior Mirror Precautions	111
Manually Dimming the Interior Mirror	111
Auto-Dimming Interior Mirror	111

Exterior Mirrors

Adjusting the Exterior Mirrors	112
Folding the Exterior Mirrors - Vehicles With: Manual Folding Mirrors	112
Folding the Exterior Mirrors - Vehicles With: Power Folding Mirrors	112
Auto-Dimming Exterior Mirror	113

Moonroof

Opening and Closing the Sunshade	114
Opening and Closing the Moonroof	114
Venting the Moonroof	114
Moonroof Bounce-Back	115

Instrument Cluster

Instrument Cluster Overview - Vehicles With: 8 Inch Screen	116
Instrument Cluster Overview - Vehicles With: 12 Inch Screen	116
Tachometer	117
Speedometer	117
Fuel Gauge	118
Engine Coolant Temperature Gauge	118
Engine Oil Pressure Gauge - Vehicles With: 8 Inch Screen	118
Engine Oil Pressure Gauge - Vehicles With: 12 Inch Screen	118
Transmission Fluid Temperature Gauge - Vehicles With: 8 Inch Screen	118
Transmission Fluid Temperature Gauge - Vehicles With: 12 Inch Screen	119
What Are the Instrument Cluster Warning Lamps	119
Instrument Cluster Warning Lamps	119

Table of Contents

What Are the Instrument Cluster Indicators	120
Instrument Cluster Indicators - Excluding: Raptor	121
Instrument Cluster Indicators - Raptor	122

Instrument Cluster Display

Using the Instrument Cluster Display Controls - Excluding: Raptor	125
Using the Instrument Cluster Display Controls - Raptor	125
Instrument Cluster Display Main Menu - Vehicles With: 12 Inch Screen, Excluding: Raptor	126
Instrument Cluster Display Main Menu - Raptor, Vehicles With: 12 Inch Screen	128
Instrument Cluster Display Main Menu - Vehicles With: 8 Inch Screen	130
Customizing the Instrument Cluster Display - Vehicles With: 8 Inch Screen	132
Customizing the Instrument Cluster Display - Vehicles With: 12 Inch Screen	132

Personalized Settings

Changing the Language	133
Changing the Measurement Unit	133
Changing the Temperature Unit	133
Changing the Tire Pressure Unit	133

Trip Computer

Accessing the Trip Computer	134
Resetting the Trip Computer	134

Remote Start

What Is Remote Start	135
Remote Start Precautions	135
Remote Start Limitations	135
Enabling Remote Start	135

Remotely Starting and Stopping the Vehicle	135
Extending the Remote Start Duration	136
Remote Start Remote Control Indicators	136
Remote Start Settings	136

Climate Control - Vehicles With: Automatic Temperature Control

Identifying the Climate Control Unit	137
Switching Climate Control On and Off	137
Switching Recirculated Air On and Off	137
Switching Air Conditioning On and Off	137
Switching Maximum Defrost On and Off	137
Switching Maximum Cooling On and Off	137
Switching the Heated Rear Window On and Off	138
Setting the Blower Motor Speed	138
Setting the Temperature	138
Directing the Flow of Air	138
Auto Mode	138

Climate Control - Vehicles With: Manual Temperature Control

Identifying the Climate Control Unit	140
Switching Climate Control On and Off	140
Switching Recirculated Air On and Off	140
Switching Air Conditioning On and Off	140
Switching Maximum Defrost On and Off	140
Switching Maximum Cooling On and Off	140

Table of Contents

Switching the Heated Rear Window On and Off	141
Setting the Blower Motor Speed	141
Setting the Temperature	141
Directing the Flow of Air	141
Climate Control Hints	141

Interior Air Quality

What Is the Cabin Air Filter	143
Replacing the Cabin Air Filter	143

Front Seats

Front Seat Precautions	144
Sitting in the Correct Position	144
Manual Seats	145
Power Seats	147
Heated Seats	149

Rear Seats

Manual Seats	151
--------------------	-----

Rear Occupant Alert System

What is the Rear Occupant Alert System	154
How Does the Rear Occupant Alert System Work	154
Rear Occupant Alert System Precautions	154
Rear Occupant Alert System Limitations	154
Switching Rear Occupant Alert System On and Off	154
Rear Occupant Alert System Indicators	155
Rear Occupant Alert System Audible Warnings	155

Memory Function

What Is the Memory Function	156
Memory Function Precautions	156

Locating the Memory Function Buttons	156
Saving a Preset Position	156
Recalling a Preset Position	156

Garage Door Opener

Garage Door Opener Introduction	157
Garage Door Opener Precautions and Frequencies	157
Programming the Garage Door Opener	158
Garage Door Opener Additional Assistance	160

USB Ports

Locating the USB Ports	161
Playing Media Using the USB Port	161
Charging a Device	162

Power Outlet - Vehicles With: 120V Power Outlet

What Is the Power Outlet	163
Power Outlet Precautions	163
Power Outlet Limitations	163
Locating the Power Outlets	163
Power Outlet Indicators	163

Power Outlet - Vehicles With: 12V Power Outlet

What Is the Power Outlet	165
Power Outlet Precautions	165
Locating the Power Outlets	165

Wireless Accessory Charger

What Is the Wireless Accessory Charger	166
Wireless Accessory Charger Precautions	166
Locating the Wireless Accessory Charger	166
Charging a Wireless Device	166

Table of Contents

Wireless Accessory Charger – Troubleshooting	167
---	-----

Storage

Cup Holders	168
Glove Compartment	168
Center Console	169
Under Seat Storage	169
Glasses Holder	169

Starting and Stopping the Engine

Starting and Stopping the Engine – Precautions	170
Ignition Switch	170
Push Button Ignition Switch	171
Starting the Engine	171
Engine Block Heater	172
Stopping the Engine	173
Automatic Engine Stop	174
Accessing the Passive Key Backup Position – Vehicles With: Push Button Start	175
Starting and Stopping the Engine – Troubleshooting	176

Auto-Start-Stop

What Is Auto-Start-Stop	179
Auto-Start-Stop Precautions	179
Switching Auto-Start-Stop On and Off	179
Stopping the Engine	179
Restarting the Engine	179
Auto-Start-Stop Indicators	179
Auto-Start-Stop – Troubleshooting	180

Fuel and Refueling

Fuel and Refueling Precautions	182
Fuel Quality	182
Locating the Fuel Filler Funnel	183

Running Out of Fuel	183
Refueling	185
Fuel Tank Capacity	186
Fuel and Refueling – Troubleshooting	187

Catalytic Converter

What Is the Catalytic Converter	188
Catalytic Converter Precautions	188
Catalytic Converter – Troubleshooting	188

Automatic Transmission

Automatic Transmission Precautions	189
Automatic Transmission Positions	189
Shifting Your Vehicle Into Gear - Vehicles With: Electronic Shift	190
Shifting Your Vehicle Into Gear - Vehicles With: Mechanical Shift	190
Automatic Transmission Position Indicators	191
Automatic Transmission Audible Warnings - Vehicles With: Electronic Shift	191
Automatic Transmission Audible Warnings - Vehicles With: Mechanical Shift	191
Manually Shifting Gears	191
Temporary Neutral Mode - Vehicles With: Electronic Shift	193
Automatic Return to Park (P) - Vehicles With: Electronic Shift	194
Brake Shift Interlock - Vehicles With: Mechanical Shift	194
Manual Park Release - Vehicles With: Electronic Shift	195

Four-Wheel Drive

How Does Four-Wheel Drive Work - 4x4 with Part Time Engagement	199
How Does Four-Wheel Drive Work - Advanced 4x4 with 4A Mode	199

Table of Contents

Four-Wheel Drive Precautions	199	Brakes – Troubleshooting	217
Four-Wheel Drive Limitations - Excluding: Raptor	200	Electric Parking Brake	
Four-Wheel Drive Limitations - Raptor	202	What Is the Electric Parking Brake	219
Switching Four-Wheel Drive On and Off	203	Applying the Electric Parking Brake	219
Selecting a Four-Wheel Drive Mode - 4x4 with Part Time Engagement	203	Applying the Electric Parking Brake in an Emergency	219
Selecting a Four-Wheel Drive Mode - Advanced 4x4 with 4A Mode	204	Manually Releasing the Electric Parking Brake	219
Four-Wheel Drive Modes	204	Automatically Releasing the Electric Parking Brake	220
Four-Wheel Drive Indicators	205	Electric Parking Brake Audible Warning	220
Transfer Case Fluid Capacity and Specification	205	Releasing the Electric Parking Brake if the Vehicle Battery Has Run Out of Charge	220
Four-Wheel Drive – Troubleshooting	205	Electric Parking Brake – Troubleshooting	220
Electronic Locking Differential		Reverse Brake Assist	
What Is the Electronic Locking Differential - Excluding: Raptor	208	What Is Reverse Brake Assist	222
What Is the Electronic Locking Differential - Raptor	208	How Does Reverse Brake Assist Work	222
Switching the Electronic Locking Differential On and Off - Excluding: Raptor	209	Reverse Brake Assist Precautions	222
Switching the Electronic Locking Differential On and Off - Raptor	210	Switching Reverse Brake Assist On and Off	223
Electronic Locking Differential Indicators - Excluding: Raptor	211	Overriding Reverse Brake Assist	223
Electronic Locking Differential Indicators - Raptor	211	Reverse Brake Assist Indicators	223
Electronic Locking Differential – Troubleshooting	212	Reverse Brake Assist – Troubleshooting	224
Brakes		Hill Start Assist	
Brake Precautions	215	What Is Hill Start Assist	226
Anti-Lock Braking System	215	How Does Hill Start Assist Work	226
Brake Over Accelerator	215	Hill Start Assist Precautions	226
Locating the Brake Fluid Reservoir	215	Switching Hill Start Assist On and Off	226
Checking the Brake Fluid	216	Hill Start Assist – Troubleshooting	226
Brake Fluid Specification	216	Auto Hold	
		How Does Auto Hold Work	227
		Switching Auto Hold On and Off	227

Table of Contents

Using Auto Hold	227
Auto Hold Indicators	227

Traction Control

What Is Traction Control	229
How Does Traction Control Work	229
Switching Traction Control On and Off	229
Traction Control Indicator	229
Traction Control – Troubleshooting	230

Stability Control

How Does Stability Control Work	231
Switching Stability Control On and Off	232
Stability Control Indicator	233
Stability Control – Troubleshooting	234

Trail Control - Raptor

What Is Trail Control	235
Trail Control Limitations	235
Switching Trail Control On and Off	235
Setting the Trail Control Speed	235
Canceling the Set Speed	235
Trail Control Indicators	236
Trail Control – Troubleshooting	237

Trail Turn Assist

What Is Trail Turn Assist	238
Trail Turn Assist Precautions	238
Trail Turn Assist Limitations	238
Switching Trail Turn Assist On and Off	238
Trail Turn Assist Indicators	238
Trail Turn Assist – Troubleshooting	239

Steering

Electric Power Steering	240
Steering – Troubleshooting	240

Parking Aids

Parking Aid Precautions	243
Switching Parking Aid On and Off	243
Rear Parking Aid	244
Front Parking Aid	244
Side Parking Aid	245
Parking Aid Indicators	247
Parking Aids – Troubleshooting	247

Rear View Camera

What Is the Rear View Camera - Vehicles With: Digital Rear View Camera	248
What Is the Rear View Camera - Vehicles With: Analog Rear View Camera	248
Rear View Camera Precautions	248
Locating the Rear View Camera	248
Rear View Camera Guide Lines	249
Rear View Camera Settings	249

360 Degree Camera

What Is the 360 Degree Camera	251
How Does the 360 Degree Camera Work	251
360 Degree Camera Precautions	251
Locating the 360 Degree Cameras	251
360 Degree Camera Guide Lines	252
360 Degree Camera Settings	253

Active Park Assist

What Is Active Park Assist	255
How Does Active Park Assist Work - Vehicles With: Fully Active Park Assist	255
How Does Active Park Assist Work - Vehicles With: Semi Active Park Assist	255
Active Park Assist Precautions	255
Switching Active Park Assist On and Off - Vehicles With: Fully Active Park Assist	255

Table of Contents

Switching Active Park Assist On and Off - Vehicles With: Semi Active Park Assist	256
Entering a Parallel Parking Space - Vehicles With: Fully Active Park Assist	256
Entering a Parallel Parking Space - Vehicles With: Semi Active Park Assist	257
Entering a Perpendicular Parking Space - Vehicles With: Fully Active Park Assist	257
Entering a Perpendicular Parking Space - Vehicles With: Semi Active Park Assist	258
Exiting a Parking Space - Vehicles With: Fully Active Park Assist	258
Exiting a Parking Space - Vehicles With: Semi Active Park Assist	259
Active Park Assist – Troubleshooting	259
Cruise Control	
What Is Cruise Control	261
Switching Cruise Control On and Off	261
Setting the Cruise Control Speed	261
Canceling the Set Speed	262
Resuming the Set Speed	262
Cruise Control Indicators	262
Adaptive Cruise Control	
How Does Adaptive Cruise Control Work	263
How Does Adaptive Cruise Control With Stop and Go Work	263
Adaptive Cruise Control Precautions	263
Adaptive Cruise Control Limitations	264
Switching Adaptive Cruise Control On and Off	266
Adaptive Cruise Control Automatic Cancellation	266
Setting the Adaptive Cruise Control Speed	266
Setting the Adaptive Cruise Control Gap	267
Canceling the Set Speed	268
Resuming the Set Speed	268
Overriding the Set Speed	270
Adaptive Cruise Control Indicators	270
Switching From Adaptive Cruise Control to Cruise Control	270
Lane Centering	270
Lane Centering – Troubleshooting	273
Intelligent Adaptive Cruise Control	274
Intelligent Adaptive Cruise Control – Troubleshooting	275
Adaptive Cruise Control – Troubleshooting	276
Drive Mode Control - Excluding: Raptor	
What Is Drive Mode Control	278
How Does Drive Mode Control Work	278
Selecting a Drive Mode	278
Selecting a Drive Mode	279
Drive Modes	279
Drive Mode Control - Raptor	
What Is Drive Mode Control	282
How Does Drive Mode Control Work	282
Selecting a Drive Mode	282
Drive Modes	284
Intelligent Speed Limiter	
What Is the Intelligent Speed Limiter	287
How Does the Intelligent Speed Limiter Work	287
Intelligent Speed Limiter Precautions	287

Table of Contents

Switching the Intelligent Speed Limiter On and Off	287
Setting the Speed Limit	287
Changing the Set Speed Limit	287
Adjusting the Speed Limit Tolerance	288
Canceling the Set Speed Limit	288
Resuming the Set Speed Limit	288
Intentionally Exceeding the Set Speed Limit	288
Intelligent Speed Limiter Indicators	288
Intelligent Speed Limiter Audible Warnings	288
Switching From Intelligent Speed Limiter to Speed Limiter	288
Intelligent Speed Limiter – Troubleshooting	289

Lane Keeping System

What Is the Lane Keeping System	290
How Does the Lane Keeping System Work	290
Lane Keeping System Precautions	290
Lane Keeping System Limitations	290
Switching the Lane Keeping System On and Off	291
Switching the Lane Keeping System Mode	291
Lane Keeping System Settings	291
Alert Mode	292
Aid Mode	292
Alert and Aid Mode	292
Lane Keeping System Indicators	293
Blind Spot Assist	294
Blind Spot Assist with Trailer Coverage	296
Lane Keeping System – Troubleshooting	298

Blind Spot Information System

What Is Blind Spot Information System	301
How Does Blind Spot Information System Work	301
Blind Spot Information System Precautions	301
Blind Spot Information System Limitations	301
Blind Spot Information System Requirements	301
Switching Blind Spot Information System On and Off	302
Locating the Blind Spot Information System Sensors	302
Blind Spot Information System With Trailer Coverage	303
Blind Spot Information System Indicators	305
Blind Spot Information System – Troubleshooting	305

Cross Traffic Alert

What Is Cross Traffic Alert	307
How Does Cross Traffic Alert Work	307
Cross Traffic Alert Precautions	307
Cross Traffic Alert Limitations	307
Switching Cross Traffic Alert On and Off	308
Locating the Cross Traffic Alert Sensors	308
Cross Traffic Alert Indicators	308
Cross Traffic Alert – Troubleshooting	309

Pre-Collision Assist

What Is Pre-Collision Assist	310
How Does Pre-Collision Assist Work	310
Pre-Collision Assist Precautions	310
Pre-Collision Assist Limitations	311

Table of Contents

Switching Pre-Collision Assist On and Off	312	What Is the Gross Axle Weight Rating	324
Locating the Pre-Collision Assist Sensors	312	What Is the Gross Vehicle Weight Rating	324
Distance Indication	313	What Is the Gross Combined Weight Rating	324
Distance Alert	314	Calculating Payload	325
Automatic Emergency Braking	315	Calculating the Load Limit	325
Evasive Steering Assist	315		
Pre-Collision Assist – Troubleshooting	316		
		Pickup Bed	
Speed Sign Recognition		Pickup Bed Precautions	328
What Is Speed Sign Recognition	318	Pickup Bed Anchor Points	328
How Does Speed Sign Recognition Work	318	Pickup Bed Slots	330
Speed Sign Recognition Precautions	318	Pickup Bed Access Caps	330
Speed Sign Recognition Limitations	318		
Speed Sign Recognition Indicators	318	Connecting a Trailer	
Setting the Speed Sign Recognition Speed Warning	319	Connecting a Trailer Precautions	331
Setting the Speed Sign Recognition Speed Tolerance	319	Connecting a Trailer	331
Speed Sign Recognition – Troubleshooting	319	Trailer Lighting Check	332
		Connecting a Trailer – Troubleshooting	333
Driver Alert			
What Is Driver Alert	321	Towing a Trailer	
How Does Driver Alert Work	321	Towing a Trailer Precautions	334
Driver Alert Precautions	321	Trailer Brake Precautions	334
Driver Alert Limitations	321	Towing a Trailer Limitations	335
Switching Driver Alert On and Off	322	Loading Your Trailer	335
Driver Alert Indicators	322	Trailer Towing Hints	335
Driver Alert – Troubleshooting	322	Launching or Retrieving a Boat or Personal Watercraft	336
		Towing Weights and Dimensions	337
		Towing a Trailer – Troubleshooting	339
Load Carrying			
Load Carrying Precautions	323	Integrated Trailer Brake Controller	
Using a Slide-In Camper	324	What Is the Integrated Trailer Brake Controller	340
Locating the Safety Compliance Certification Labels	324	Integrated Trailer Brake Controller Precautions	340
		Using the Integrated Trailer Brake Controller	340

Table of Contents

Adjusting the Integrated Trailer Brake Controller Mode	341
Integrated Trailer Brake Controller – Troubleshooting	342

Trailer Sway Control

How Does Trailer Sway Control Work	344
Trailer Sway Control Precautions	344
Switching Trailer Sway Control On and Off	344

Trailer Backup Assistance

What is Trailer Backup Assistance	345
How Does Trailer Backup Assistance Work	345
Trailer Backup Assistance Precautions	345
Setting Up the Trailer Backup Assistance for a Conventional Trailer	345
Switching Trailer Backup Assistance On and Off	348
Using the Trailer Backup Assistance Controller	349
Using the Trailer Backup Assistance Views	349
Trailer Backup Assistance – Troubleshooting	352

Trailer Reverse Guidance

What Is Trailer Reverse Guidance	356
How Does Trailer Reverse Guidance Work	356
Trailer Reverse Guidance Precautions	356
Setting Up Trailer Reverse Guidance for a Conventional Trailer	356
Switching Trailer Reverse Guidance On and Off	359
Using Trailer Reverse Guidance Views	359
Trailer Reverse Guidance – Troubleshooting	361

Off-Road Driving

Basic Off-Road Driving Techniques	365
Driving Your Vehicle at High Speeds	366
Driving Through Water Limitations	366
Water Wading - Excluding: Raptor	367
Water Wading - Raptor	368
Off-Road Driving Aids	368
After Driving Your Vehicle Off-Road	369
Off-Road Screen	370

Driving Hints

Breaking-In	374
Driving Economically	374
Driving in Cold Weather	374
Floor Mats	375

Crash and Breakdown Information

Roadside Assistance	376
Switching the Hazard Flashers On and Off	377
Jump Starting the Vehicle	377
Post-Crash Alert System	379
Post-Collision Braking	379
Automatic Crash Shutoff	380
Recovery Towing	380
Transporting the Vehicle	382
Fail-Safe Cooling	383

Towing Your Vehicle

Towing Your Vehicle Precautions	385
Recreationally Towing Your Vehicle	385
Emergency Towing	385

Fuses

Fuse Precautions	386
Under Hood Fuse Box	386

Table of Contents

Battery Fuse Box	396	Department of Transportation Uniform Tire Quality Grades	433
Body Control Module Fuse Box	396	Information on the Tire Sidewall	434
Identifying Fuse Types	400	Glossary of Tire Terminology	439
Fuses – Troubleshooting	400	Tire Replacement Requirements	440
Maintenance		Using Snow Chains - Excluding: Raptor	442
Maintenance Precautions	401	Using Snow Chains - Raptor	443
Opening and Closing the Hood	401	Using Bead-Lock Wheels - Raptor	445
Under Hood Overview - 2.3L EcoBoost™	403	Tire Care	
Under Hood Overview - 2.7L EcoBoost™	404	Checking the Tire Pressures	447
Under Hood Overview - 3.0L EcoBoost™	405	Inflating the Tires	447
Engine Oil	406	Inspecting the Tire for Wear	448
Engine Air Filter	407	Inspecting the Tire for Damage	448
Coolant	408	Inspecting the Wheel Valve Stems	450
Changing the Fuel Filter	411	Tire Rotation	450
Drive Belt Routing Overview - 2.3L EcoBoost™	412	Tire Pressure Monitoring System	
Drive Belt Routing Overview - 2.7L EcoBoost™/3.0L EcoBoost™	412	What Is the Tire Pressure Monitoring System	452
12V Battery	412	Tire Pressure Monitoring System Overview	452
12V Battery – Troubleshooting	415	Tire Pressure Monitoring System Precautions	453
Adjusting the Headlamps	416	Tire Pressure Monitoring System Limitations	453
Exterior Bulbs	417	Viewing the Tire Pressures	454
Interior Bulbs	425	Tire Pressure Monitoring System – Troubleshooting	454
Vehicle Care		Changing a Road Wheel	
Cleaning the Exterior	426	Changing a Flat Tire - Excluding: Raptor	456
Cleaning the Interior	428	Changing a Flat Tire - Raptor	463
Repairing Minor Paint Damage	429	Wheel Nuts	470
Waxing Your Vehicle	430	Capacities and Specifications	
Storing Your Vehicle		Engine Specifications - 2.3L EcoBoost™	471
Preparing Your Vehicle for Storage	431		
Removing Your Vehicle From Storage	432		
Wheel and Tire Information			
Locating the Tire label	433		

Table of Contents

Engine Specifications - 2.7L EcoBoost™472	Connected Vehicle Limitations493
Engine Specifications - 3.0L EcoBoost™473	Connecting the Vehicle to a Mobile Network493
Motorcraft Parts - 2.3L EcoBoost™474	Connecting the Vehicle to a Wi-Fi Network493
Motorcraft Parts - 2.7L EcoBoost™475	Connected Vehicle – Troubleshooting494
Motorcraft Parts - 3.0L EcoBoost™476	
Engine Oil Capacity and Specification - 2.3L EcoBoost™477	Vehicle Wi-Fi Hotspot
Engine Oil Capacity and Specification - 2.7L EcoBoost™478	Creating a Vehicle Wi-Fi Hotspot496
Engine Oil Capacity and Specification - 3.0L EcoBoost™480	Changing the Vehicle Wi-Fi Hotspot Name or Password497
Cooling System Capacity and Specification - 2.3L EcoBoost™482	Vehicle Wi-Fi Hotspot – Troubleshooting497
Cooling System Capacity and Specification - 2.7L EcoBoost™482	
Cooling System Capacity and Specification - 3.0L EcoBoost™483	Audio System
Fuel Tank Capacity484	Audio System Precautions498
Air Conditioning System Capacity and Specification - 2.3L EcoBoost™485	Switching the Audio Unit On and Off498
Air Conditioning System Capacity and Specification - 2.7L EcoBoost™486	Selecting the Audio Source498
Air Conditioning System Capacity and Specification - 3.0L EcoBoost™487	Playing or Pausing the Audio Source498
Washer Fluid Specification487	Adjusting the Volume498
Automatic Transmission Fluid Capacity and Specification488	Switching Shuffle Mode On and Off498
Brake Fluid Specification488	Switching Repeat Mode On and Off498
Transfer Case Fluid Capacity and Specification489	Setting a Memory Preset499
Front Axle Fluid Capacity and Specification490	Adjusting the Sound Settings499
Rear Axle Fluid Capacity and Specification490	Setting the Clock and Date499
	FM Radio499
	Digital Radio500
	Satellite Radio501
	Audio System – Troubleshooting503
Vehicle Identification	Center Display
Vehicle Identification Number492	Center Display Overview507
	Status Bar507
Connected Vehicle	Settings508
What Is a Connected Vehicle493	Rebooting the Center Display509
Connected Vehicle Requirements493	

Table of Contents

Voice Interaction

What is Voice Interaction	510
Setting the Wake Word	510
Beginning a Voice Interaction	510
Voice Interaction Examples	510

Alexa Built-In

What is Alexa Built-In	512
Alexa Built-In Requirements	512
Signing In to Your Account	512
Using Alexa Built-In	512
Alexa Built-In Settings	512

Phone

Phone Precautions	514
Connecting Your Phone	514
Phone Menu	514
Making and Receiving a Phone Call	515
Sending and Receiving a Text Message	516
Switching Text Message Notification On and Off	517

Bluetooth®

Connecting a Bluetooth® Device	518
Playing Media Using Bluetooth®	518

Apps

App Precautions	519
App Requirements	519
Enabling Apps on an iOS Device	519
Enabling Apps on an Android Device	519
Switching Apple CarPlay On and Off	519
Switching Android Auto On and Off	519

Navigation

Connected Navigation	521
Accessing Navigation	521

Navigation Map Updates	521
Adjusting the Map	521
Live Traffic	521
Setting a Destination	521
Waypoints	522
Route Guidance	522
Trailer Towing Navigation	523

Vehicle Software Updates

Vehicle Software Updates	524
Software Update Settings	524
Software Update Indicators	525

Vehicle System Reset

Performing a System Reset	526
---------------------------------	-----

Accessories

Accessories	527
-------------------	-----

Auxiliary Switches

What Are the Auxiliary Switches	529
Locating the Auxiliary Switches	529
Locating the Auxiliary Switch Wiring	529
Identifying the Auxiliary Switch Wiring	530

Ford Protect

What Is Ford Protect	532
----------------------------	-----

Scheduled Maintenance

General Maintenance Information	534
---------------------------------------	-----

Customer Information

Rollover Warning	538
The Better Business Bureau Auto Line Program	538
The Mediation and Arbitration Program	539
Ordering a Canadian French Owner's Manual	539

Table of Contents

Reporting Safety Defects in the United States	540
Reporting Safety Defects in Canada	540
Third Party Software Copyright Acknowledgment	541
Radio Frequency Certification Labels	541
Perchlorate	581
Replacement Parts Recommendation	581
Mobile Communications Equipment	582
Federal Highway Administration Regulation	582
End User License Agreement	583
Emission Law	608
Export Unique Options	609
Warranty Information	609

Appendices

Electromagnetic Compatibility	611
-------------------------------------	-----

About Us

SVT

The Ford Special Vehicle Team (SVT) was established in 1991 to polish the Ford Oval by creating low-volume, factory-produced vehicles designed for those select few whose idea of driving is a high-powered, passionate experience – not just a means of getting from point A to point B.

In a move to support this spirited enthusiasm, Ford Motor Company carefully integrated the wide array of talent in the company into a small, cross-functional group of engineers and product planners, housed together under one roof with a common mission: to create vehicles specifically designed to meet the unique needs and desires of the knowledgeable driving enthusiast.

More than 400,000 SVT and Ford Performance vehicles were produced since the 1993 model year. These include the SVT Mustang Cobra and the Cobra R, the SVT F-150 Lightning, the SVT Contour, the SVT Focus, Ford GT, Shelby GT350, Shelby GT500, GT500KR and the F-150 SVT Raptor.

TEAM RS

Team RS traces its roots back nearly 60 years from the Lotus Ford Cortina and Twin Cam Escorts of the mid 1960's, through the first RS branded Escorts of the 1970's to the founding of Special Vehicle Engineering (SVE) in 1980. Through the 1980s and 90s, SVE delivered a breadth of vehicles from exciting XR and RS branded road going performance cars through homologation specials such as the iconic Sierra Cosworth RS500. The first ST (Sport Technology) vehicle appeared in 1996 as the ST24 Mondeo. The first collaboration between Ford's European and North American performance teams appeared in 2002 as the ST170 in Europe

and SVT Focus in North America. In 2003, Team RS replaced SVE in Europe as performance car and motorsport personnel were brought together as one team. Team RS subsequently created the 2004 Fiesta ST, 2005 Focus ST and 2009 Focus RS.

FORD PERFORMANCE

Welcome to the Ford Performance family!

SVT and Team RS officially began working together as one team in 2009. In 2015, these two teams, along with Ford Racing, were formally combined establishing Ford Performance as a single team responsible for all performance and racing oriented products and activities worldwide at Ford Motor Company. Your Ford Performance vehicle represents the best of what Ford Performance has to offer from around the globe. Your vehicle has been designed and developed with the four hallmarks of Ford Performance in mind: Performance, Substance, Exclusivity and Value. We are proud and passionate about what we do, and we are glad you have made us your choice.

Contacting Us

If you require assistance or clarification on policies or procedures, please contact the customer relationship center.

United States

Ford Motor Company
Customer Relationship Center
PO Box 6248
Dearborn, MI 48126
1-800-392-3673 (FORD)
TDD for the hearing impaired:
7-1-1 (where offered by your telephone
service provider)
www.ford.com/help/contact/

Ford Credit - US Only

Ford Credit offers a full range of financing and lease plans to help you acquire your vehicle. If you have financed or leased your vehicle through Ford Credit, thank you for your business.

For assistance call 1-800-727-7000, or for more information about Ford Credit and access to an account manager, visit www.ford.com/finance.

Canada

Customer Relationship Centre
Ford Motor Company of Canada Limited
P.O. Box 2000
Oakville, Ontario L6J 5E4
1-800-565-3673 (FORD)
TDD for the hearing impaired:
7-1-1 (where offered by your telephone
service provider)
www.ford.ca

Australia

Ford Motor Company of Australia Pty Ltd.
Customer Relationship Centre
Private Mail Bag 5
Campbellfield, Victoria, 3061
Telephone: (13 FORD) 13 3673
E-mail: foacust1@ford.com

New Zealand

Ford Motor Company
Attention: Customer Relationship Centre
Private Bag 76912
Manukau City 2241
Telephone: 0800 367 369 (FORDNZ)
E-mail: fnzcust@ford.com

China - Imported Vehicle

Customer Relationship Center
Telephone: 400-690-1886
Website: <https://www.ford.com.cn/>

China - Chang'An Ford

Customer Relationship Center
Telephone: 800-810-8168
Mobile: 400-887-7766
Website: <https://www.ford.com.cn/>

Asia Pacific Direct Markets (APDM)

E-mail: apemcrc@ford.com

Caribbean, Central America and Israel

Ford Motor Company
Ford Export Operations
Attention: Owner Relations
1555 Fairlane Drive
Fairlane Business Park #3
Allen Park, MI 48101
Fax: (313) 390-0804
Telephone: (313) 594-4857
E-mail: expcac@ford.com

U.S. Virgin Islands and Puerto Rico

Ford Motor Company
Ford Export Operations
Attention: Owner Relations
1555 Fairlane Drive
Fairlane Business Park #3
Allen Park, MI 48101
Telephone: (800) 841-3673
E-mail: prcac@ford.com

Contacting Us

Argentina

Telephone: 0800-888-3673

Brazil

Website: www.ford.com.br
Telephone: 0800-703-3673
E-mail: central@ford.com

North Africa

E-mail: nafcrc@ford.com

South Africa

Telephone: 0860011022
Email: fordcrc2@ford.com

Sub-Saharan Africa

E-mail: ssacrc@ford.com

Puerto Rico

Ford International Business Development,
Inc.
P.O. Box 11957
Caparra Heights Station
San Juan, PR 00922-1957
1-800-392-3673 (FORD)
Fax: (313) 390-0804
E-mail: prcac@ford.com
www.ford.com.pr

Middle East

Ford Middle East Customer Relationship
Center
P.O. Box 21740
Dubai, United Arab Emirates
Telephone: 80004441066
Toll-free number for the Kingdom of Saudi
Arabia: 8008443673
Mobily and Zain cell phone users in Saudi
Arabia: 800850078
Kuwait: 22280384
Local telephone number for Kuwait: +965
1 898900
Fax: +971 4 3327266
E-mail: menacac@ford.com
www.me.ford.com

South Korea

Customer Relationship Center
Telephone: +82-02-1600-6003
E-mail: infokr1@ford.com
Emergency Dispatch Service call:
080-300-3673

Philippines

Telephone: 02-88669408
Email: emailus@ford.com

Taiwan

Telephone: 0800-032100
705 Zhonghua Rd., Sec. 1
Zhongli District, Taoyuan, Taiwan, 32068

Thailand

Telephone: 1383
E-mail: fordthai@ford.com

Vietnam

Telephone: 1800588888
E-mail: fordvn@ford.com

Introduction

ABOUT THIS PUBLICATION



WARNING: Driving while distracted can result in loss of vehicle control, crash and injury. We strongly recommend that you use extreme caution when using any device that may take your focus off the road. Your primary responsibility is the safe operation of your vehicle. We recommend against the use of any hand-held device while driving and encourage the use of voice-operated systems when possible. Make sure you are aware of all applicable local laws that may affect the use of electronic devices while driving.



WARNING: You risk death, fire, or serious injury to yourself and others if you do not follow the instruction highlighted by the warning symbol.

Thank you for choosing Ford. We recommend that you take some time to get to know your vehicle in order to benefit from greater safety and pleasure from driving it. Use this publication to familiarize yourself with the basics and then read the digital version, that is available in your vehicle. You can also view the comprehensive manual through the FordPass app and through the local Ford website.

Note: To download the FordPass app, visit your device's app store.

Note: To find the local Ford website, visit <https://corporate.ford.com/operations/locations/global-links.html>.

Note: Use and operate your vehicle in line with all applicable laws and regulations.

Note: Pass on all printed owner's information when selling this vehicle.

Our digital resources include a comprehensive digital Owner's Manual dynamically created according to the features on your vehicle by using the vehicle identification number. See **Locating the Vehicle Identification Number** (page 492). The digital Owner's Manual includes visual and full text search functions so that you can quickly locate the information you are looking for. It also includes links to a number of how-to videos created to help you understand some of the advanced technologies on your vehicle.

Features and Options

This publication describes product features and options available throughout the range of available models, sometimes even before they are generally available. It could describe options that are not available on the vehicle you have purchased.

Illustrations

Some of the illustrations in this publication could show features as used in different models, so they could appear different to you on your vehicle.

Location of Components

This manual may qualify the location of a component as left-hand side or right-hand side. The side is determined when facing forward in the seat.

Introduction

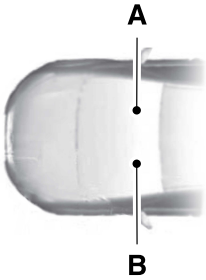

- A Right-hand side.
- B Left-hand side.





























USING THIS PUBLICATION

To quickly locate information about your vehicle, use the word search within the Owner's Manual application.

Symbols Glossary

SYMBOLS USED ON YOUR VEHICLE

These are some of the symbols you may see on your vehicle.

	Airbag		Child safety door lock or unlock
	Air conditioning system		Child seat lower anchor
	Air conditioning system lubricant type		Child seat tether anchor
	Anti-lock braking system		Cruise control
	Avoid smoking, flames or sparks		Do not open when hot
	Battery		Electric Parking brake
	Battery acid		Engine air filter
	Blower motor		Engine coolant
	Brake fluid - non petroleum based		Engine coolant temperature
	Brake system		Engine oil
	Brake system		Explosive gas
	Cabin air filter		Fan warning
	Check fuel cap		Fasten seatbelt
			Flammable
			Front fog lamps

Symbols Glossary



Fuel pump reset



Fuse compartment



Hazard flashers



Headlamp high beams



Headlamps on



Heated rear window



Hill descent control



Horn control



Interior luggage compartment release



Jack



Keep out of reach of children



Lighting control



Low fuel level



Low tire pressure warning



Maintain correct fluid level



Malfunction Indicator Lamp (MIL)



Note operating instructions



Panic alarm



Parking aid



Parking lamps



Passenger airbag activated



Passenger airbag deactivated



Power steering fluid



Power windows front/rear



Power window lockout



Requires registered technician



Safety alert



See Owner's Manual



See Service Manual



Side airbag

Symbols Glossary



Shield the eyes



Stability control



Stability control off



Trail control



Turn Signal



Windshield defrosting system



Windshield wiping system



Windshield wash and wipe

Data Privacy



WARNING: Do not connect wireless plug-in devices to the data link connector. Unauthorized third parties could gain access to vehicle data and impair the performance of safety related systems. Only allow repair facilities that follow our service and repair instructions to connect their equipment to the data link connector.

We respect your privacy and are committed to protecting it. The information contained in this publication was correct at the time of release, but as technology rapidly changes, we recommend that you visit the local Ford website for the latest information.

Your vehicle has electronic control units that have data recording functionality and the ability to permanently or temporarily store data. This data could include information on the condition and status of your vehicle, vehicle maintenance requirements, events and malfunctions. The types of data that can be recorded are described in this section. Some of the data recorded is stored in event logs or error logs.

Note: *Error logs are reset following a service or repair.*

Note: *We may provide information in response to requests from law enforcement, other government authorities and third parties acting with lawful authority or through a legal process. Such information could be used by them in legal proceedings.*

Data recorded includes, for example:

- Operating states of system components, for example fuel level, tire pressure and battery charge level.
- Vehicle and component status, for example wheel speed, deceleration, lateral acceleration and seatbelt status.

- Events or errors in essential systems, for example headlamps and brakes.
- System responses to driving situations, for example airbag deployment and stability control.
- Environmental conditions, for example temperature.

Some of this data, when used in combination with other information, for example an accident report, damage to a vehicle or eyewitness statements, could be associated with a specific person.

Services That We Provide

If you use our services, we collect and use data, for example account information, vehicle location and driving characteristics, that could identify you. We transmit this data through a dedicated, protected connection. We only collect and use data to enable your use of our services to which you have subscribed, with your consent or where permitted by law. For additional information, see the terms and conditions of the services to which you have subscribed.

For additional information about our privacy policy, refer to the local Ford website.

Services That Third Parties Provide

We recommend that you review the terms and conditions and data privacy information for any services equipped with your vehicle or to which you subscribe. We take no responsibility for services that third parties provide.

Where equipped, SiriusXM with 360L could use the modem. To disable, turn off the SiriusXM with 360L or Vehicle Connectivity setting. See **Enabling and Disabling the Modem** (page 493).

Data Privacy

SERVICE DATA

Service data recorders in your vehicle are capable of collecting and storing diagnostic information about your vehicle. This potentially includes information about the performance or status of various systems and modules in the vehicle, such as engine, throttle, steering or brake systems. In order to properly diagnose and service your vehicle, Ford Motor Company (Ford of Canada in Canada), and service and repair facilities may access or share among them vehicle diagnostic information received through a direct connection to your vehicle when diagnosing or servicing your vehicle. Additionally, Ford Motor Company (Ford of Canada, in Canada) may, where permitted by law, use vehicle diagnostic information for vehicle improvement or with other information we may have about you, for example, your contact information, to offer you products or services that may interest you. Data may be provided to our service providers such as part suppliers that may help diagnose malfunctions, and who are similarly obligated to protect data. We retain this data only as long as necessary to perform these functions or to comply with law. We may provide information where required in response to official requests to law enforcement or other government authorities or third parties acting with lawful authority or court order, and such information may be used in legal proceedings. For U.S. only (if equipped), if you choose to use connected apps and services, you consent that certain diagnostic information may also be accessed electronically by Ford Motor Company and Ford authorized service facilities, and that the diagnostic information may be used to provide services to you, personalizing your experience, troubleshoot, and to improve products and services and offer you products and services that may interest

you, where permitted by law. For Canada only, for more information, please review the Ford of Canada privacy policy at www.ford.ca, including our U.S. data storage and use of service providers in other jurisdictions who may be subject to legal requirements in Canada, the United States and other countries applicable to them, for example, lawful requirements to disclose personal information to governmental authorities in those countries.

EVENT DATA

This vehicle is equipped with an event data recorder. The main purpose of an event data recorder is to record, in certain crash or near crash-like situations, such as an airbag deployment or hitting a road obstacle; this data will assist in understanding how a vehicle's systems performed. The event data recorder is designed to record data related to vehicle dynamics and safety systems for a short period of time, typically 30 seconds or less.

The event data recorder in this vehicle is designed to record such data as:

- How various systems in your vehicle were operating.
- Whether or not the driver and passenger seatbelts were buckled/fastened.
- How far (if at all) the driver was depressing the accelerator and/or the brake pedal.
- How fast the vehicle was traveling.
- Where the driver was positioning the steering wheel.

This data can help provide a better understanding of the circumstances in which crashes and injuries occur.

Data Privacy

Note: *Event data recorder data is recorded by your vehicle only if a non-trivial crash situation occurs; no data is recorded by the event data recorder under normal driving conditions and no personal data or information (for example name, gender, age, and crash location) is recorded. However, parties, such as law enforcement, could combine the event data recorder data with the type of personally identifying data routinely acquired during a crash investigation.*

To read data recorded by an event data recorder, special equipment is required, and access to the vehicle or the event data recorder is needed. In addition to the vehicle manufacturer, other parties, such as law enforcement, that have such special equipment, can read the information if they have access to the vehicle or the event data recorder.

SETTINGS DATA

Your vehicle has electronic control units that have the ability to store data based on your personalized settings. The data is stored locally in the vehicle or on devices that you connect to it, for example, a USB drive or digital music player. You can delete some of this data and also choose whether to share it through the services to which you subscribe.

Comfort and Convenience Data

Data recorded includes, for example:

- Seat and steering wheel position.
- Climate control settings.
- Radio presets.

Entertainment Data

Data recorded includes, for example:

- Music, videos or album art.
- Contacts and corresponding address book entries.
- Navigation destinations.

CONNECTED VEHICLE DATA



The modem has a SIM. The modem was enabled when your vehicle was built and periodically sends messages to stay connected to the cell phone network, receive automatic software updates and send vehicle-related information to us, for example diagnostic information. These messages could include information that identifies your vehicle, the SIM and the electronic serial number of the modem. Cell phone network service providers could have access to additional information, for example cell phone network tower identification. For additional information about our privacy policy, visit www.FordConnected.com or refer to your local Ford website.

Note: *The modem continues to send this information unless you disable the modem or stop the modem from sharing vehicle data by changing the modem settings. See **Connected Vehicle** (page 493).*

Note: *The service can be unavailable or interrupted for a number of reasons, for example environmental or topographical conditions and data plan coverage.*

Note: *To find out if your vehicle has a modem, visit www.FordConnected.com.*

Data Privacy

MOBILE DEVICE DATA

If you connect a mobile device to your vehicle, you can display data from your device on the touchscreen for example, music and album art. You can share your vehicle data with mobile apps on your device through the system. See **App Requirements** (page 519).

The mobile apps function operates by your connected device sending data to us in the United States. The data is encrypted and includes, for example, the vehicle identification number of your vehicle, the SYNC module serial number, odometer, enabled apps, usage statistics and debugging information. We retain it only as long as necessary to provide the service, to troubleshoot, for continuous improvement and to offer you products and services that may be of interest to you according to your preferences and where allowed by law.

If you connect a cell phone to the system, the system creates a profile that links to that cell phone. The cell phone profile enables more mobile features and efficient operation. The profile contains, for example data from your phonebook, read and unread text messages and call history, including history of calls when your cell phone was not connected to the system.

If you connect a media device, the system creates and retains a media device index of supported media content. The system also records a short diagnostic log of approximately 10 minutes of all recent system activity.

The cell phone profile, media device index and diagnostic log remain in your vehicle unless you delete them and are generally accessible only in your vehicle when you connect your cell phone or media device. If you no longer plan to use the system or your vehicle, we recommend you use the system reset function to erase the stored information. See **Performing a System Reset** (page 526).

System data cannot be accessed without special equipment and access to your vehicle's module.

For additional information about our privacy policy, refer to the local Ford website.

Note: *To find out if your vehicle has connectivity technology, visit www.FordConnected.com.*

EMERGENCY CALL SYSTEM DATA

When the emergency call system is active, it may disclose to emergency services that your vehicle has been in a crash involving the deployment of an airbag or activation of the fuel pump shut-off. Certain versions or updates to the emergency call system may also be capable of electronically or verbally disclosing to emergency services operators your vehicle location or other details about your vehicle or crash to assist emergency services operators to provide the most appropriate emergency services. If you do not want to disclose this information, do not activate the emergency call system.

Note: *You cannot deactivate emergency call systems that are required by law.*

Environment

PROTECTING THE ENVIRONMENT

Sustainability is a priority at Ford. We are constantly looking for ways to reduce our impact on the planet while providing customers with great products and delivering a strong business. You should play your part in protecting the environment. Correct vehicle usage and the authorized disposal of waste, cleaning and lubrication materials are significant steps toward this aim.

For additional information about our sustainability progress and initiatives, visit www.sustainability.ford.com.

Visual Search

STEERING WHEEL - EXCLUDING: RAPTOR

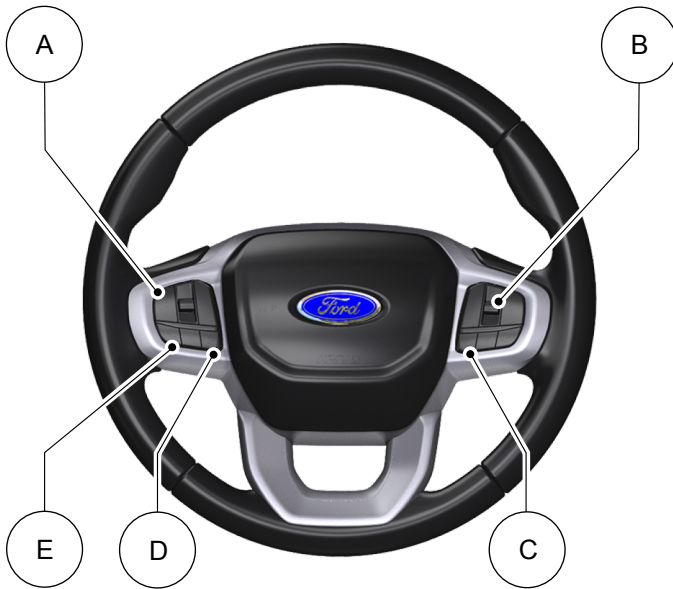

- A See **Switching Cruise Control On and Off** (page 261). See **Switching Adaptive Cruise Control On and Off** (page 266).
- B See **Using the Instrument Cluster Display Controls** (page 125).
- C See **Making and Receiving a Phone Call** (page 515).
- D See **Beginning a Voice Interaction** (page 510).
- E See **Adjusting the Volume** (page 498).

Visual Search

STEERING WHEEL - RAPTOR



- A See **Switching Cruise Control On and Off** (page 261). See **Switching Adaptive Cruise Control On and Off** (page 266).
- B See **Using the Instrument Cluster Display Controls** (page 125).
- C See **Selecting a Drive Mode** (page 282).
- D See **Beginning a Voice Interaction** (page 510).

Visual Search

INSTRUMENT PANEL - EXCLUDING: RAPTOR

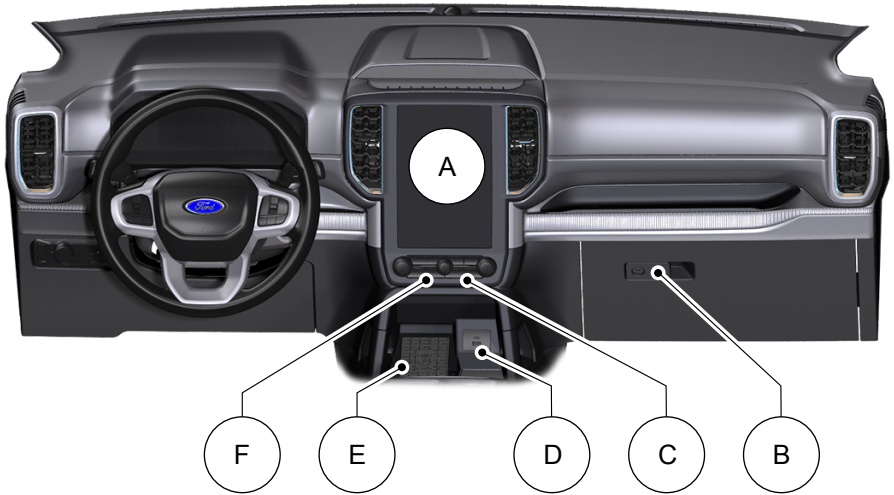

- A See **Center Display Overview** (page 507).
- B See **Opening the Glove Compartment** (page 168).
- C See **Identifying the Climate Control Unit** (page 137). See **Identifying the Climate Control Unit** (page 140).
- D See **Charging a Device** (page 162).
- E See **Charging a Wireless Device** (page 166).
- F See **Switching the Hazard Flashers On and Off** (page 377).

Visual Search

INSTRUMENT PANEL - RAPTOR

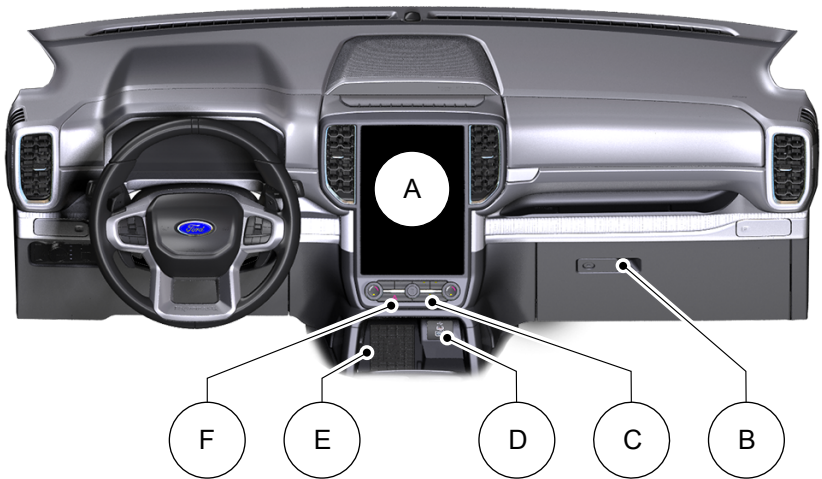

- A See **Center Display Overview** (page 507).
- B See **Opening the Glove Compartment** (page 168).
- C See **Identifying the Climate Control Unit** (page 137). See **Identifying the Climate Control Unit** (page 140).
- D See **Charging a Device** (page 162).
- E See **Charging a Wireless Device** (page 166).
- F See **Switching the Hazard Flashers On and Off** (page 377).

Visual Search

VEHICLE INTERIOR - EXCLUDING: RAPTOR

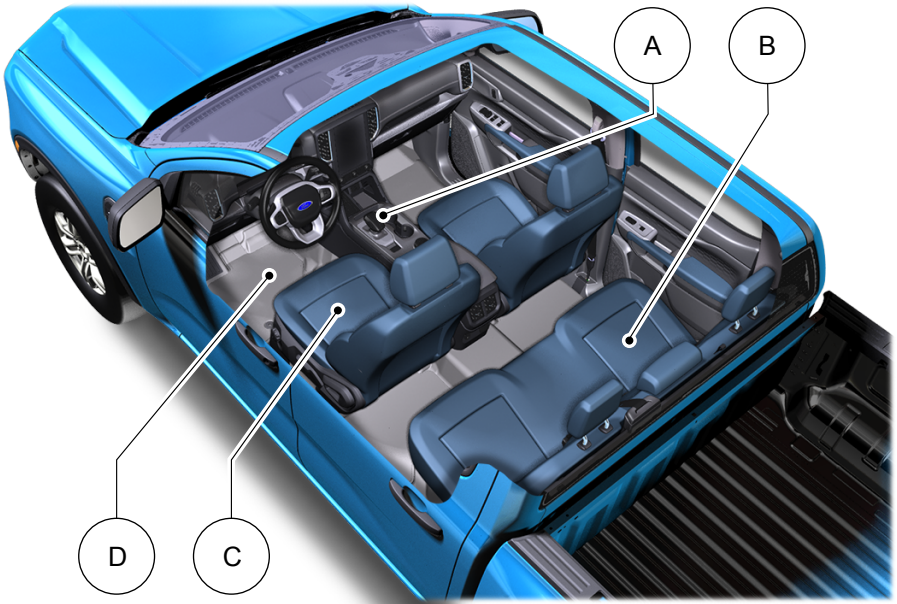

- A See **Automatic Transmission Position Indicators** (page 191).
- B See **Unfolding the Seat Backrest** (page 152).
- C See **Sitting in the Correct Position** (page 144).
- D See **Floor Mats** (page 375).

Visual Search

VEHICLE INTERIOR - RAPTOR

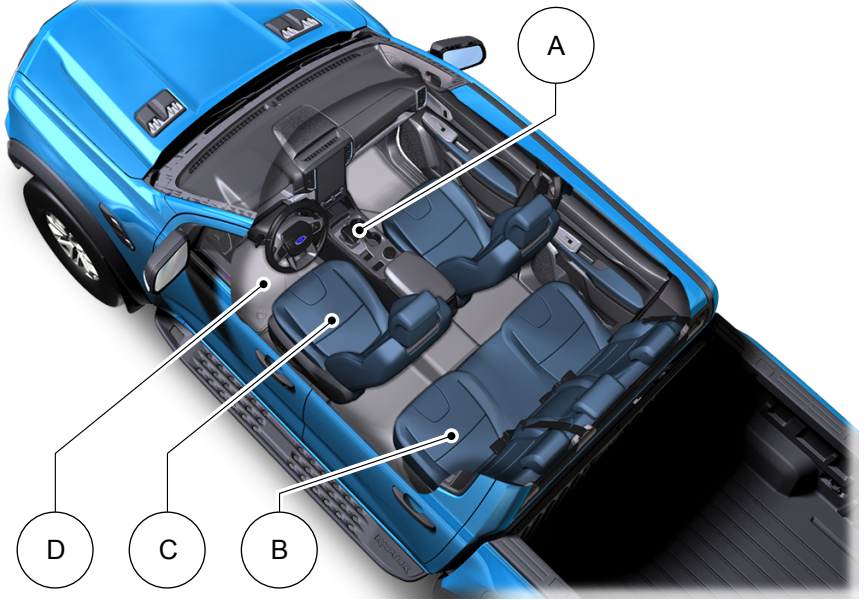

- A See **Automatic Transmission Position Indicators** (page 191).
- B See **Unfolding the Seat Backrest** (page 152).
- C See **Sitting in the Correct Position** (page 144).
- D See **Floor Mats** (page 375).

Visual Search

FRONT EXTERIOR - EXCLUDING: RAPTOR

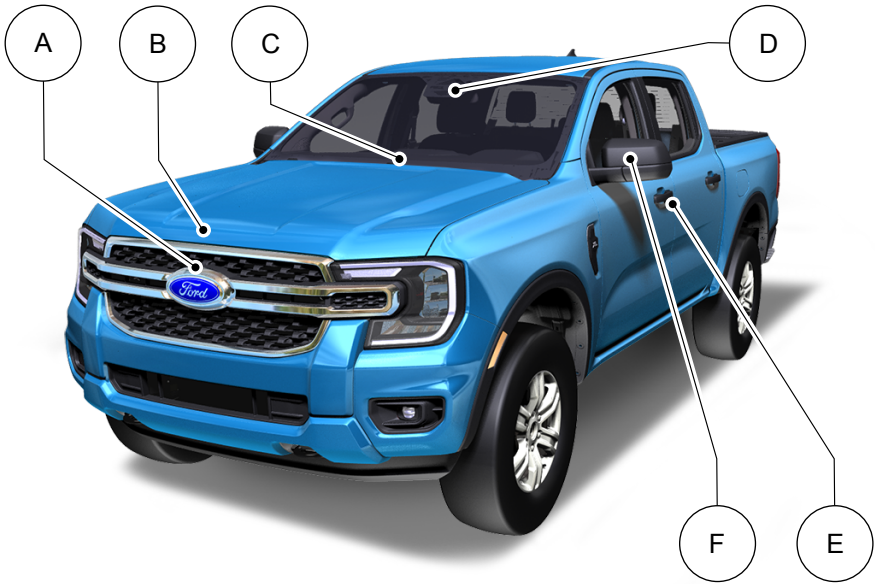

- A See **Locating the 360 Degree Cameras** (page 251).
- B See **Opening and Closing the Hood** (page 401).
- C See **Replacing the Front Wiper Blades** (page 93).
- D See **What Is the Lane Keeping System** (page 290).
- E See **Unlocking and Locking the Doors Using the Key Blade** (page 79). See **Unlocking and Locking the Doors Using the Remote Control** (page 79).
- F See **Adjusting the Exterior Mirrors** (page 112).

Visual Search

FRONT EXTERIOR - RAPTOR

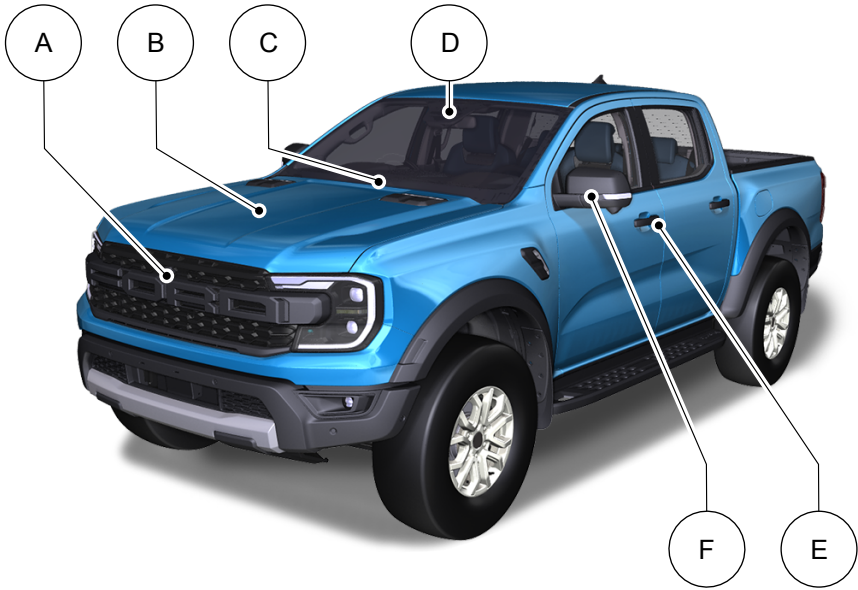

- A See **Locating the 360 Degree Cameras** (page 251).
- B See **Opening and Closing the Hood** (page 401).
- C See **Replacing the Front Wiper Blades** (page 93).
- D See **What Is the Lane Keeping System** (page 290).
- E See **Unlocking and Locking the Doors Using the Key Blade** (page 79), See **Unlocking and Locking the Doors Using the Remote Control** (page 79).
- F See **Adjusting the Exterior Mirrors** (page 112).

Visual Search

REAR EXTERIOR - EXCLUDING: RAPTOR

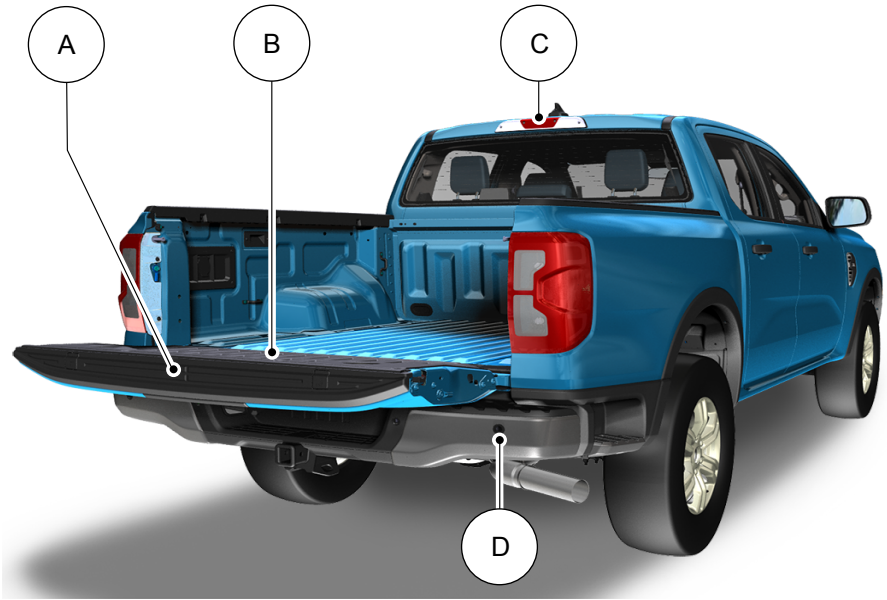

- A See **Opening the Tailgate From Outside Your Vehicle** (page 85).
- B See **Tailgate Work Surface** (page 85).
- C See **Locating the 360 Degree Cameras** (page 251).
- D See **Locating the Rear Parking Aid Sensors** (page 244).

Visual Search

REAR EXTERIOR - RAPTOR

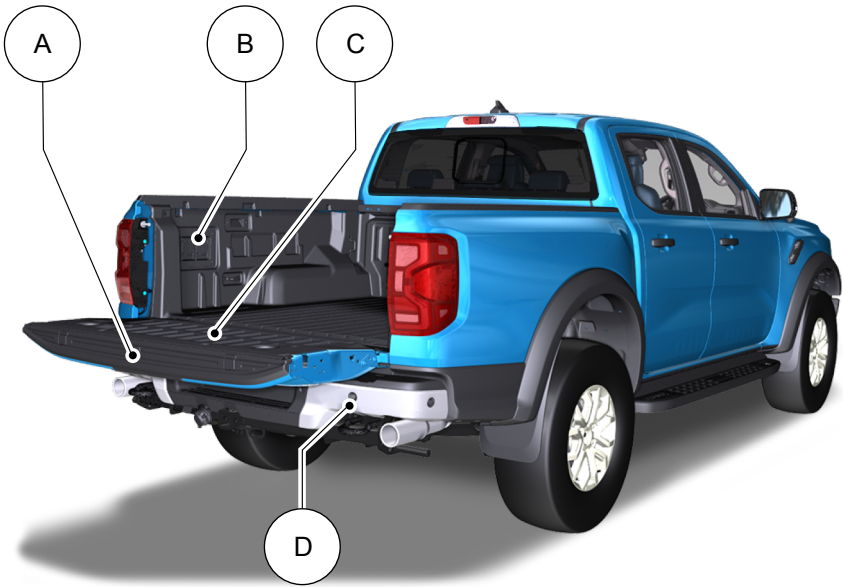

- A See **Opening the Tailgate From Outside Your Vehicle** (page 85).
- B See **Power Outlet Precautions** (page 163).
- C See **Tailgate Work Surface** (page 85).
- D See **Locating the Rear Parking Aid Sensors** (page 244).

Unique Features - Raptor

UNIQUE FEATURES

Powertrain

- 3.0L Twin Turbo EcoBoost engine.
- 10R60 10-speed automatic transmission with Magnesium paddle shifters and water to air transmission cooler.
- Electronic Transfer Case with Front Locking Differential.
- Rear differential capable of locking in 4A, 4H and 4L.
- Electronically controlled Twin Pipe Active Exhaust with switchable modes and black 3-inch tips.
- Anti Lag Technology available in Baja Mode.

Chassis

- Cast aluminum lower control arms.
- Steel upper control arms.
- Fox Factory 2.5 Live Valve Internal Bypass front shocks.
- Fox Factory 2.5 Live Valve Internal Bypass Remote Reservoir rear shocks.
- Unique underbody shields.
- Heavy duty reinforced frame.
- Unique Watts Link Rear suspension.
- Ride height sensors at each corner.
- 33 inch All Terrain Tires on 17-inch wheels.

Exterior

- Modified rear bumper with integrated rear tow hooks.
- Underbody shields plus front tow hooks.
- Hood with functional air extractors.
- Front and rear LED marker lamps.

- 17 x 8.5 aluminum wheels.
- Optional 17 x 8.5 bead lock compatible wheels.

Interior

- Unique terrain-mode and trail control functionality plus six auxiliary switches.
- Unique front and rear seats with code orange accents.
- SYNC 4.0 with off-road screen and 360-degree camera.
- Unique steering wheel with switches to control and customize MyMode, exhaust and damping.

Child Safety

CHILD SAFETY PRECAUTIONS



WARNING: Always make sure your child is secured properly in a device that is appropriate for their height, age and weight. Child safety restraints must be bought separately from your vehicle. Failure to follow these instructions and guidelines may result in an increased risk of serious injury or death to your child.



WARNING: All children are shaped differently. The National Highway Traffic Safety Administration and other safety organizations, base their recommendations for child restraints on probable child height, age and weight thresholds, or on the minimum requirements of the law. We recommend that you check with a NHTSA Certified Child Passenger Safety Technician (CPST) to make sure that you properly install the child restraint in your vehicle and that you consult your pediatrician to make sure you have a child restraint appropriate for your child. To locate a child restraint fitting station and CPST, contact NHTSA toll free at 1-888-327-4236 or go to www.nhtsa.dot.gov. In Canada, contact Transport Canada toll free at 1-800-333-0371 or go to www.tc.gc.ca to find a Child Car Seat Clinic in your area. Failure to properly restrain children in child restraints made especially for their height, age and weight, may result in an increased risk of serious injury or death to your child.



WARNING: On hot days, the temperature inside the vehicle can rise very quickly. Exposure of people or animals to these high temperatures for even a short time can cause death or serious heat related injuries, including brain damage. Small children are particularly at risk.



WARNING: Do not place a rearward facing child restraint in front of an active airbag. Failure to follow this instruction could result in personal injury or death.



WARNING: Properly secure children 12 years old and under in a rear seating position whenever possible. If you are unable to properly secure all children in a rear seating position, properly secure the largest child on the front seat. If you must use a forward facing child restraint on the front seat, move the seat as far back as possible. Failure to follow these instructions could result in personal injury or death.



WARNING: Always carefully follow the instructions and warnings provided by the manufacturer of any child restraint to determine if the restraint device is appropriate for your child's size, height, weight, or age. Follow the child restraint manufacturer's instructions and warnings provided for installation and use in conjunction with the instructions and warnings provided by your vehicle manufacturer. A safety seat that is improperly installed or utilized, is inappropriate for your child's height, age, or weight or does not properly fit the child may increase the risk of serious injury or death.

Child Safety

WARNING: Do not allow a passenger to hold a child on their lap when your vehicle is moving. Failure to follow this instruction could result in personal injury or death in the event of a sudden stop or crash.

WARNING: Do not use pillows, books or towels to boost your child's height. Failure to follow this instruction could result in personal injury or death.

WARNING: Properly secure child restraints or booster seats when they are not in use. They could become projectiles in a sudden stop or crash. Failure to follow this instruction could result in personal injury or death.

WARNING: Do not put the shoulder section of the seatbelt or allow the child to put the shoulder section of the seatbelt under their arm or behind their back. Failure to follow this instruction could reduce the effectiveness of the seatbelt and increase the risk of injury or death in a crash.

WARNING: Do not leave children or pets unattended in your vehicle. Failure to follow this instruction could result in personal injury or death.

When installing a child restraint with seatbelts:

- Place the vehicle seat in the upright position before you install the child restraint.
- Use the correct seatbelt buckle for that seating position.
- Insert the belt tongue into the buckle. Make sure the tongue is securely fastened in the buckle.

- Keep the buckle release button pointing up and away from the child restraint, with the tongue between the child restraint and the release button, to prevent accidental unbuckling.
- Put the seatbelt in the automatic locking mode.

CHILD RESTRAINT ANCHOR POINTS

WHAT ARE THE CHILD RESTRAINT ANCHOR POINTS

Anchor points allow you to quickly and safely install a child restraint.

LOCATING THE CHILD RESTRAINT LOWER ANCHOR POINTS



Child Safety

LOCATING THE CHILD RESTRAINT TOP TETHER ANCHOR POINTS



CHILD RESTRAINTS

CHILD RESTRAINT POSITION INFORMATION

Install the child restraint tightly against the vehicle seat. It may be necessary to lift or remove the head restraint.

Rear Facing Child Restraints

Combined Weight of Child and Child Restraint	LATCH (Lower Anchors Only)	Seatbelt Only
Up to 65 lb (29 kg)	X	X
Over 65 lb (29 kg)		X

Forward Facing Child Restraints

Combined Weight of Child and Child Restraint	LATCH (Lower Anchors and Top Tether Anchor)	Seatbelt and Top Tether Anchor	Seatbelt and LATCH (Lower Anchors and Top Tether Anchor)
Up to 65 lb (29 kg)	X	X	X
Over 65 lb (29 kg)		X	X

Child Safety

CHILD RESTRAINTS RECOMMENDATION

Child Size, Height, Weight, or Age	Recommended Restraint Type
Children weighing 40 lb (18 kg) or less (generally age four or younger).	Use a child restraint (sometimes called an infant carrier, convertible seat, or toddler seat).
Children who have outgrown or no longer properly fit in a child restraint (generally children who are less than 57 in (1.45 m) tall, are greater than age four and less than age 12, and between 40 lb (18 kg) and 80 lb (36 kg) and upward to 100 lb (45 kg) if recommended by your child restraint manufacturer).	Use a belt-positioning booster seat.
Children who have outgrown or no longer properly fit in a belt-positioning booster seat (generally children who are at least 57 in (1.45 m) tall or greater than 80 lb (36 kg) or 100 lb (45 kg) if recommended by child restraint manufacturer).	Use a vehicle seatbelt having the lap belt snug and low across the hips, shoulder belt centered across the shoulder and chest, and seat backrest upright.

You are required by law to properly use child restraints for infants and toddlers in the United States, Canada and Mexico.

Many states and provinces require that small children use approved booster seats until they reach age eight, a height of 57 in (1.45 m) tall, or 80 lb (36 kg). Check your local and state or provincial laws for specific requirements about the safety of children in your vehicle.

When possible, properly restrain children 12 years of age and under in a rear seating position of your vehicle. Accident statistics suggest that children are safer when properly restrained in the rear seating positions than in a front seating position.

When installing a rear facing child restraint, adjust the vehicle seats to avoid interference between the child restraint and the vehicle seat in front of the child restraint.

INSTALLING CHILD RESTRAINTS

USING SEATBELTS



WARNING: Depending on where you secure a child restraint, and depending on the child restraint design, you may block access to certain seatbelt buckle assemblies and LATCH lower anchors, rendering those features potentially unusable. To avoid risk of injury, make sure occupants only use seating positions where they are able to be properly restrained.

Note: *Although the child restraint illustrated is a forward-facing child restraint, the steps are the same for installing a rear-facing child restraint.*

Perform the following steps when installing the child restraint with seatbelts:

Child Safety

1. Position the child restraint in a seat with a seatbelt.



2. After positioning the child restraint in the proper seating position, pull down on the shoulder belt and then grasp the shoulder belt and lap belt together behind the belt tongue.

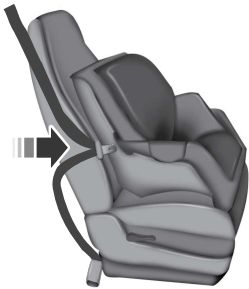

3. While holding the shoulder and lap belt portions together, route the tongue through the child restraint according to the child restraint manufacturer's instructions. Make sure that you did not twist the belt webbing.

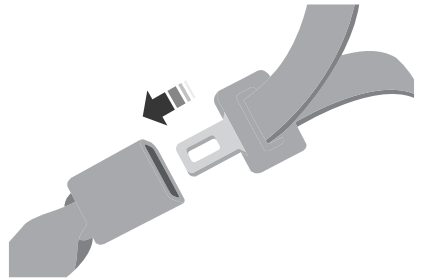

4. Insert the belt tongue into the proper buckle (the buckle closest to the direction the tongue is coming from) for that seating position until you hear a snap and feel the latch engage. Make sure the tongue is latched securely by pulling on it.



5. To put the retractor in the automatic locking mode, grasp the shoulder portion of the belt and pull downward until you pull all of the belt out.

Note: *The automatic locking mode is available on the front passenger and rear seats.*

6. Allow the belt to retract to remove slack. The belt clicks as it retracts to indicate it is in the automatic locking mode.

Child Safety

7. Try to pull the belt out of the retractor to make sure the retractor is in the automatic locking mode. You should not be able to pull more belt out. If the retractor did not lock, unbuckle the belt and repeat Steps 5 and 6.



8. Remove remaining slack from the belt. Force the seat down with extra weight, for example, by pressing down or kneeling on the child restraint while pulling up on the shoulder belt in order to force slack from the belt. This is necessary to remove the remaining slack that exists once you add the extra weight of the child to the child restraint. It also helps to achieve the proper snugness of the child restraint to your vehicle. Sometimes, a slight lean toward the buckle will provide extra help to remove remaining slack from the belt.
9. If the child restraint has a tether strap, attach it.

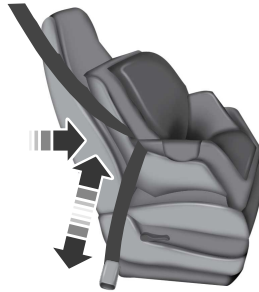

10. Before placing the child in the seat, forcibly move the seat forward and back to make sure the seat is securely held in place. To check this, grab the seat at the belt path and attempt to move it side to side and forward and back. There should be no more than 1 in (2.5 cm) of movement.

We recommend checking with a NHTSA Certified Child Passenger Safety Technician to make certain the child restraint is properly installed. In Canada, check with Transport Canada for referral to a Child Car Seat Clinic.

USING LOWER ANCHORS AND TETHERS FOR CHILDREN



WARNING: Do not attach two child safety restraints to the same anchor. In a crash, one anchor may not be strong enough to hold two child safety restraint attachments and may break, causing serious injury or death.

Child Safety



WARNING: Depending on where you secure a child restraint, and depending on the child restraint design, you may block access to certain seatbelt buckle assemblies and LATCH lower anchors, rendering those features potentially unusable. To avoid risk of injury, make sure occupants only use seating positions where they are able to be properly restrained.

The LATCH (Lower Anchors and Tethers for CHildren) system has three vehicle anchor points.

- Two lower anchors where the seat backrest and seat cushion meet, called the seat bight.
- One top tether anchor behind that seating position.

LATCH-compatible child restraints have two rigid or webbing mounted attachments that connect to the two lower anchors at the LATCH-equipped seating positions in your vehicle. This type of attachment method eliminates the need to use seatbelts to attach the child restraint.

However, you can still use the seatbelt to attach the child restraint. For forward-facing child restraints, you must also attach the top tether strap to the proper top tether anchor if a top tether strap has been provided with your child restraint.

Follow the instructions on attaching child restraints with tether straps.

INSTALLING A CHILD RESTRAINT IN A CENTER SEAT



WARNING: The standardized spacing for LATCH lower anchors is 11 in (280 mm) center to center. Do not use LATCH lower anchors for the center seating position unless the child restraint manufacturer's instructions permit and specify using anchors spaced at least as far apart as those in this vehicle.

The lower anchors at the center of the second row rear seat are spaced 18 in (46 cm) apart. You cannot install a child restraint with rigid LATCH attachments at the center seating position. You can only use LATCH compatible child restraints with attachments on belt webbing at this seating position provided that the child restraint manufacturer's instructions permit use with the anchor spacing stated. Do not attach a child restraint to any lower anchor if an adjacent child restraint is attached to that anchor.

Each time you use the child restraint, check that the seat is properly attached to the lower anchors and tether anchor, if applicable. Tug the child restraint from side to side and forward and back where it is secured to your vehicle. The seat should move less than 1 in (2.5 cm).

If you did not properly anchor the child restraint, the risk of a child being injured in a crash greatly increases.

Child Safety

COMBINING THE SEATBELT AND LOWER ANCHORS FOR ATTACHING CHILD RESTRAINTS

When used in combination, you may attach either the seatbelt or the LATCH lower anchors first, provided a proper installation is achieved. Attach the tether strap afterward, if it is included with the child restraint.

USING TETHER STRAPS

Many forward-facing child restraints include a tether strap which extends from the back of the child restraint and hooks to an anchoring point called the top tether anchor. Tether straps are available as an accessory for many older child restraints.

Contact the manufacturer of your child restraint for information about ordering a tether strap, or to obtain a longer tether strap if the tether strap on your child restraint does not reach the appropriate top tether anchor in your vehicle.

Once you install the child restraint using either the seatbelt, the lower anchors of the LATCH system, or both, you can attach the top tether strap.

Perform the following steps to install a child restraint with tether anchors.

Note: *If you install a child restraint with rigid LATCH attachments, do not tighten the tether strap enough to lift the child restraint off your vehicle seat cushion when the child is seated in it. Keep the tether strap just snug without lifting the front of the child restraint. Keeping the child restraint just touching your vehicle seat gives the best protection in a severe crash.*

1. Route the child restraint tether strap over the back of the seat. For the outermost seating positions, route the tether strap under the head restraint and between the head restraint posts. For the center seating position, route the tether strap over the top of the head restraint.
2. To access the top tether anchors, pull the strap on the top of the rear seat backrest and fold the backrest forward.

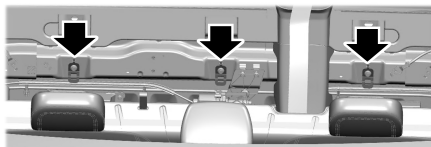

3. Locate the correct anchor for the selected seating position.



4. Clip the tether strap to the anchor as shown.
5. Tighten the child restraint tether strap according to the manufacturer's instructions. If your child restraint system has a tether strap, and the child restraint manufacturer recommends its use, we also recommend its use.

Child Safety

- Return the rear seat backrest to its original rearward and locked position. Pull slightly on the seat backrest and make sure that it is locked.

BOOSTER SEATS

Use a belt-positioning booster seat for children who have outgrown or no longer properly fit in a child restraint and meet the following criteria.

- Generally children who are less than 57 in (1.45 m) tall.
- Are greater than age four (4) and less than age twelve (12).
- Are between 40 lb (18 kg) and 80 lb (36 kg) and upward to 100 lb (45 kg).

Many state and provincial laws require that children use approved booster seats until they reach age eight, a height of 57 in (1.45 m) tall, or 80 lb (36 kg).

Booster seats should be used until you can answer yes to all of these questions when seated without a booster seat:

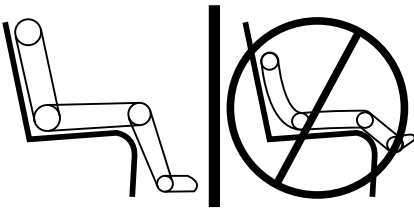

- Can the child sit all the way back against their vehicle seat backrest with knees bent comfortably at the edge of the seat cushion?
- Can the child sit without slouching?
- Does the lap belt rest low across the hips?

- Is the shoulder belt centered on the shoulder and chest?
- Can the child stay seated like this for the whole trip?

Always use booster seats in conjunction with your vehicle lap and shoulder belt.

Types of Booster Seats



- Backless booster seats

If your backless booster seat has a removable shield, remove the shield.

If a vehicle seating position has a low seat backrest or no head restraint, a backless booster seat may place your child's head, as measured at the tops of the ears, above the top of the seat. In this case, move the backless booster to another seating position with a higher seat backrest or head restraint and lap and shoulder belts, or consider using a high-back booster seat.

Child Safety



If, with a backless booster seat, you cannot find a seating position that adequately supports your child's head, a high-back booster seat would be a better choice.

Children and booster seats vary in size and shape. Choose a booster that keeps the lap belt low and snug across the hips, never up across the stomach, and lets you adjust the shoulder belt to cross the chest and rest snugly near the center of the shoulder.

The following drawings compare the ideal fit to a shoulder belt uncomfortably close to the neck and a shoulder belt that could slip off the shoulder. The drawings also show how the lap belt should be low and snug across the child's hips.

- High-back booster seats



Child Safety

If the booster seat slides on the vehicle seat upon which it is being used, placing a rubberized mesh sold as shelf or carpet liner under the booster seat may improve this condition. Do not use any item thicker than this under the booster seat. Check with the booster seat manufacturer's instructions.

Note: To make sure the child safety lock is on, pull the inside door handle twice to verify the door does not open.

Note: To open the rear doors from inside the vehicle when the child lock is engaged, roll down the rear window and use the outside door handle. Or have someone outside the vehicle open the door.

CHILD SAFETY LOCKS



WARNING: You cannot open the rear doors from inside if you have put the child safety locks on.

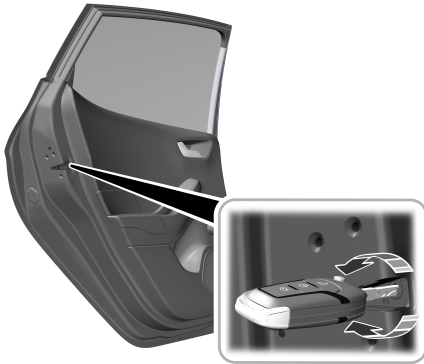

A child safety lock is on the rear edge of each rear door. You must switch the child safety lock separately on each door.

Left-Hand Side

Turn the key clockwise to switch the child lock on and counterclockwise to switch it off.

Right-Hand Side

Turn the key counterclockwise to switch the child lock on and clockwise to switch it off.

Seatbelts

SEATBELT PRECAUTIONS



WARNING: Always drive and ride with your seatback upright and the lap belt snug and low across the hips.



WARNING: Children must always be properly restrained.



WARNING: Do not allow a passenger to hold a child on their lap when your vehicle is moving. Failure to follow this instruction could result in personal injury or death in the event of a sudden stop or crash.



WARNING: All occupants of your vehicle, including the driver, should always properly wear their seatbelts, even when an airbag supplemental restraint system is provided. Failure to properly wear your seatbelt could seriously increase the risk of injury or death.



WARNING: It is extremely dangerous to ride in a cargo area, inside or outside of a vehicle. In a crash, people riding in these areas are more likely to be seriously injured or killed. Do not allow people to ride in any area of your vehicle that is not equipped with seats and seatbelts. Make sure everyone in your vehicle is in a seat and properly using a seatbelt. Failure to follow this warning could result in serious personal injury or death.



WARNING: In a rollover crash, an unbelted person is significantly more likely to die than a person wearing a seatbelt.



WARNING: Each seating position in your vehicle has a specific seatbelt assembly made up of one buckle and one tongue designed to be used as a pair. Use the shoulder belt on the outside shoulder only. Never wear the shoulder belt under the arm. Never use a single seatbelt for more than one person.



WARNING: Even with advanced restraints systems, properly restrain children 12 and under in a rear seating position. Failure to follow this could seriously increase the risk of injury or death.



WARNING: Seatbelts and seats may be hot in a vehicle that is in the sunshine. The hot seatbelts or seats may burn a small child. Check seat covers and buckles before you place a child anywhere near them.



WARNING: If your vehicle is involved in a crash, have the seatbelts and associated components inspected as soon as possible. Failure to follow this instruction could result in personal injury or death.

All seating positions in this vehicle have lap and shoulder seatbelts. All occupants of the vehicle should properly wear their seatbelts, even when an airbag supplemental restraint system is provided.

The seatbelt system consists of:

- Lap and shoulder seatbelts.
- A shoulder seatbelt with automatic locking mode, except driver seatbelt.
- Height adjusters at the front outermost seating positions.

Seatbelts

- Seatbelt pretensioners at the front outermost and second row outermost seating positions.
- Belt tension sensor at the front outermost passenger seating position.



A seatbelt warning light and tone.



Crash sensors and monitoring system with readiness indicator.

The seatbelt pretensioners are designed to tighten the seatbelts when activated. In frontal and near-frontal crashes, the seatbelt pretensioners may be activated alone or, if the crash is of sufficient severity, together with the front airbags. The pretensioners may also activate when a Safety Canopy airbag deploys.

FASTENING AND UNFASTENING THE SEATBELTS

All seatbelts in your vehicle are a three-point combination lap and shoulder seatbelt.

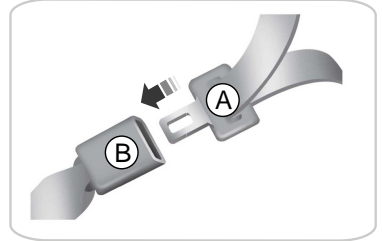

A Seatbelt tongue.

B Seatbelt buckle.

1. Pull the seatbelt out steadily.

Note: *It may lock if you pull it sharply or if the vehicle is on a slope.*

2. Insert the tongue into the buckle.
3. Pull the seatbelt tight to remove any slack.

Unfastening the Seatbelts

1. Press the red button on the buckle to release the seatbelt.
2. Hold the seatbelt tongue and let it retract completely and smoothly to its stowed position.

Seatbelts

SENSITIVE LOCKING MODE

WHAT IS SENSITIVE LOCKING MODE

Sensitive locking mode is a seatbelt retractor feature that allows shoulder belt length adjustment according to your movements and locking in response to vehicle movement.

HOW DOES SENSITIVE LOCKING MODE WORK

If the driver suddenly brakes, turns a corner sharply, or the vehicle receives an impact of about 5 mph (8 km/h) or more, the seatbelts lock to help reduce forward movement of the driver and passengers.

In addition, the seatbelt retractor locks if you pull the seatbelt webbing out too quickly. If the retractor locks, slowly lower the height adjuster to allow the seatbelt to retract.

If the retractor does not unlock, pull the seatbelt out slowly then feed a small length of webbing back toward the stowed position.

AUTOMATIC LOCKING MODE

WHAT IS AUTOMATIC LOCKING MODE

This is a safety feature built into the seatbelt retractors that keeps the seatbelts pre-locked.

ENGAGING AUTOMATIC LOCKING MODE



1. Fasten the combination lap and shoulder belt.
2. Grasp the shoulder portion and pull downward until you pull the entire belt out.
3. Allow the belt to retract. As the belt retracts, you will hear a clicking sound. This indicates the seatbelt is now in the automatic locking mode.

DISENGAGING AUTOMATIC LOCKING MODE

Unbuckle the combination lap and shoulder belt and allow it to retract completely to disengage the automatic locking mode and activate the vehicle sensitive locking mode.

Extracting Seatbelts in the Rear Outermost Seat Positions

Seatbelts in the rear outermost positions can lock if you firmly return the seat backrest to its upright position. You can unlock the seatbelts using the following procedures.

For vehicles where the rear seats recline:

1. Recline the seat to its full rear recline position.

Seatbelts

2. The seatbelt should then unlock.
3. Return the seat backrest to its desired upright position.

For vehicles with rear seats that do not recline or are locked with the seat in its full rear recline position:

1. Grasp the seatbelt webbing at the top of the seat backrest.
2. Pull the seatbelt webbing forward, firmly.
3. After pulling the seatbelt forward, allow the seatbelt to feed back into the seatbelt retractor as much as possible. If necessary, press the seat backrest down to allow the seatbelt webbing to retract further.
4. The seatbelt should then unlock.
5. If the seatbelt does not unlock, repeat steps 1-3.

ADJUSTING THE SEATBELTS DURING PREGNANCY



WARNING: Always ride and drive with your seatback upright and properly fasten your seatbelt. Fit the lap portion of the seatbelt snugly and low across the hips. Position the shoulder portion of the seatbelt across your chest. Pregnant women must follow this practice. See the following figure.

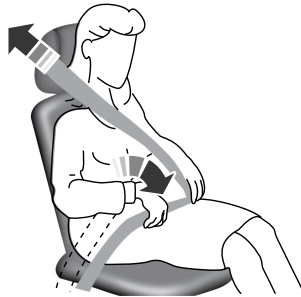

Pregnant women should always wear their seatbelt. Position the lap belt portion of a combination lap and shoulder belt low across the hips below the belly and worn as tight as comfort allows. Position the shoulder belt to cross the middle of the shoulder and the center of the chest.

ADJUSTING THE SEATBELT HEIGHT



WARNING: Position the seatbelt height adjuster so that the seatbelt rests across the middle of your shoulder. Failure to adjust the seatbelt correctly could reduce its effectiveness and increase the risk of injury in a crash.

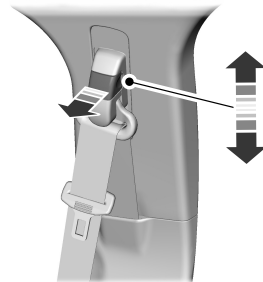

Seatbelts

1. Pull the button and slide the height adjuster up or down.
2. Release the button and pull down on the height adjuster to make sure it is locked in place.

SEATBELT REMINDER

HOW DOES THE SEATBELT REMINDER WORK



WARNING: The system will only provide protection when you use the seatbelt correctly.

This system monitors all seating positions and provides audio and graphic feedback.

SEATBELT REMINDER INDICATORS



This lamp illuminates if you do not fasten your seatbelt when you switch the ignition on. The lamp switches off when you fasten your seatbelt or about one minute has elapsed.

When the initial warning expires for the driver, more warnings are provided for the driver and front passenger. This lamp illuminates if you or your front passenger do not fasten the seatbelt buckle and the vehicle speed exceeds 6 mph (10 km/h).

Note: To avoid inadvertent warnings, do not place large objects on the front passenger seat.



This lamp illuminates when you switch the ignition on, identifying the number of seating positions with fastened buckles. It illuminates again when a seating position changes from unfastened to fastened.



This warning displays if an occupant unfastens the rear seatbelt buckle or it becomes unfastened.

Note: If a rear seat is unoccupied, or an occupant never fastens the seatbelt buckle to begin with, the warning will not display.

Note: Front seating positions appear in this warning display. Warnings for unfastened front seatbelt buckles appear in the initial warning lamp.

Seatbelt Status

To view the seatbelt status, use the information cluster controls on the steering wheel.

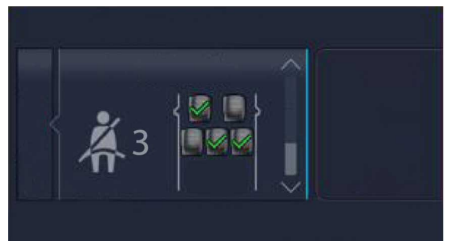

Seatbelts

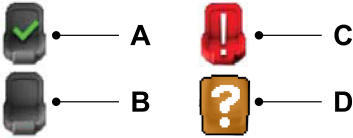

- A Seatbelt fastened.
- B Seatbelt not fastened.
- C Seatbelt recently unfastened.
- D Fault.

SEATBELT REMINDER AUDIBLE WARNINGS

A warning tone sounds if you do not fasten your seatbelt when you switch the ignition on. The tone switches off when you fasten your seatbelt or about one minute elapses.

When the initial warning expires for the driver, more warnings are provided for the driver and front passenger. This warning tone sounds if you or your front passenger do not fasten the seatbelt buckle and the vehicle speed exceeds 6 mph (10 km/h).

This tone also sounds if an occupant unfastens the rear seatbelt buckle or it becomes unfastened.

SWITCHING THE SEATBELT REMINDER ON AND OFF



WARNING: While the system allows you to deactivate it, this system is designed to improve your chances of being safely belted and surviving an accident. We recommend you leave the system activated for yourself and others who may use the vehicle.

Note: The driver and front passenger warnings switch off independently. When you perform this procedure for one seating position, do not buckle the other position as this cancels the process.

Read Steps 1 - 4 before proceeding with the programming procedure.

Make sure that:

- You set the parking brake.
 - The transmission is in park (P).
 - The ignition is off.
 - You close all vehicle doors.
 - You unfasten the driver and front passenger seatbelts.
1. Switch the ignition on. Do not start the engine.
 2. After Step 1, wait an additional five seconds before proceeding with Step 3. Once you start Step 3, you must complete the procedure within 60 seconds.
 3. For the seating position you are switching off, buckle then unbuckle the seatbelt three times at a moderate speed, ending in the unbuckled state. After Step 3, the seatbelt warning light switches on.
 4. When the seatbelt warning light is on, buckle then unbuckle the seatbelt. After Step 4, the seatbelt warning light flashes for confirmation.

This switches the feature off for that seating position if it is currently on.

This switches the feature on for that seating position if it is currently off.

Seatbelts

CHECKING THE SEATBELTS

Check the seatbelts and child restraints periodically to make sure they work properly and are not damaged. Make sure there are no nicks, tears or cuts. Replace if necessary.

Check the following seatbelt assemblies after a crash.

- Retractors.
- Buckles.
- Front seatbelt buckle assemblies.
- Shoulder belt height adjusters.
- Shoulder belt guide on seat backrest.

- Child restraint and tether anchors.
- Attaching hardware.

Read the child restraint manufacturer's instructions for additional inspection and maintenance information specific to the child restraint.

We recommend that all seatbelt assemblies in use in vehicles involved in a crash be replaced. However, if the crash was minor and an authorized dealer finds that the belts do not show damage and continue to operate properly, they do not need to be replaced. Seatbelt assemblies not in use during a crash should also be checked and replaced if either damage or improper operation is noted.

Seatbelts – Information Messages

Message	Description
Rear Belt Monitor Malfunction Service Required	The system has detected a fault that requires service. Have your vehicle checked as soon as possible.

SEATBELT EXTENSIONS



WARNING: Persons who fit into the vehicle's seatbelt should not use an extension. Unnecessary use could result in serious personal injury in the event of a crash.



WARNING: Only use extensions provided free of charge by our dealers. The dealer will provide an extension designed specifically for this vehicle, model year and seating position. The use of an extension intended for another vehicle, model year or seating position may not offer you the full protection of your vehicle's seatbelt restraint system.



WARNING: Never use seatbelt extensions to install child restraints.



WARNING: Do not use extensions to change the way the seatbelt fits across the torso, over the lap or to make the seatbelt buckle easier to reach.

If, because of body size or driving position, it is not possible to properly fasten the seatbelt over your lap and shoulder, an extension that is compatible with the seatbelts is available free of charge from our dealers. Only use our seatbelt extensions made by the original equipment seatbelt manufacturer with our seatbelts. Ask your authorized dealer if your extension is compatible with your vehicle restraint system.

Personal Safety System™

WHAT IS THE PERSONAL SAFETY SYSTEM

An advanced safety system that protects occupants in frontal crashes.

HOW DOES THE PERSONAL SAFETY SYSTEM WORK

This system provides an improved level of frontal crash protection to front seat occupants and is designed to reduce the risk of airbag-related injuries. The system analyzes occupant conditions and crash severity before activating the appropriate safety devices. During a crash, the restraints control module may deploy the seatbelt pretensioners, and one or both stages of the dual-stage airbags based on crash severity and occupant conditions.

PERSONAL SAFETY SYSTEM COMPONENTS

- Driver and passenger dual-stage airbag supplemental restraints.
 - Front seat outermost seatbelts with pretensioners, energy management retractors and seatbelt usage sensors.
 - Driver seat position sensor.
 - Passenger seat position sensor.
 - Front passenger sensing system.
 - Passenger airbag off and on indicators.
 - Front crash severity sensors.
 - Restraints control module with impact and safing sensors.
- Restraint system warning light and tone.
 - The electrical wiring for the airbags, crash sensors, seatbelt pretensioners, front seatbelt usage sensors, front passenger sensing system and indicator lights.

Airbags

HOW DO THE FRONT AIRBAGS WORK

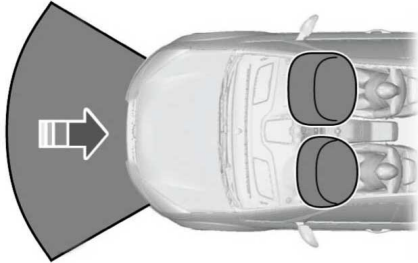

The driver and front passenger airbags deploy during significant frontal and near frontal crashes.

The driver and passenger front airbag system consists of:

- Driver and passenger airbag modules.
- Front passenger sensing system.
- Crash sensors and monitoring system with readiness indicator. See **Crash Sensors and Airbag Indicator** (page 67).

The airbags are a supplemental restraint system and are designed to work with the seatbelts to help protect the driver and right front passenger from certain upper body injuries. Airbags do not inflate slowly; there is a risk of injury from a deploying airbag.

Note: *You will hear a loud bang and see a cloud of harmless powdery residue if an airbag deploys. This is normal.*

The airbags inflate and deflate rapidly upon activation. After airbag deployment, it is normal to notice a smoke-like, powdery residue or smell the burnt propellant. This may consist of cornstarch, talcum powder (to lubricate the bag) or sodium

compounds (for example, baking soda) that result from the combustion process that inflates the airbag. Small amounts of sodium hydroxide may be present which may irritate the skin and eyes, but none of the residue is toxic.

Contact with a deploying airbag may cause abrasions or swelling. Temporary hearing loss is also a possibility as a result of the noise associated with a deploying airbag.

Because airbags must inflate rapidly and with considerable force, there is the risk of death or serious injuries such as fractures, facial and eye injuries or internal injuries, particularly to occupants who are not properly restrained or are otherwise out of position at the time of airbag deployment. Thus, it is extremely important that occupants be properly restrained as far away from the airbag module as possible.

Routine maintenance of the airbags is not required.

HOW DO THE SIDE AIRBAGS WORK



WARNING: Do not place objects or mount equipment on or near the airbag cover, on the side of the front or rear seatbacks, or in areas that may come into contact with a deploying airbag. Failure to follow these instructions may increase the risk of personal injury in the event of a crash.



WARNING: Accessory seat covers not released by Ford Motor Company could prevent the deployment of the airbags and increase the risk of injuries in a crash.

Airbags



WARNING: Do not lean your head on the door. The side airbag could injure you as it deploys from the side of the seatback.

The side airbags are on the outermost side of each front seat backrest. In certain sideways crashes or rollovers, the airbags will be inflated.

The airbag was designed to inflate between the door panel and occupant to further enhance the protection provided occupants in side impact crashes.



The system consists of the following:

- A label or embossed side panel indicating that your vehicle has side airbags.
- Side airbags inside the driver and front passenger seat backrests.
- Crash sensors and monitoring system with a readiness indicator. See **Crash Sensors and Airbag Indicator** (page 67).

HOW DO THE KNEE AIRBAGS WORK



WARNING: To reduce risk of injury, do not obstruct or place objects in the deployment path of the airbag.



WARNING: Close the glove box door when your vehicle is moving. Failure to follow this instruction could reduce the effectiveness of the passenger knee airbag and increase the risk of injury in a crash.

A driver knee airbag is under or within the instrument panel. A passenger knee airbag is within or under the glove box door.

During a crash, the restraints control module may activate the driver and passenger knee airbags based on crash severity and occupant conditions. Under certain crash and occupant conditions, the driver and passenger knee airbags may deploy, but the front airbags may not activate.

As with front and side airbags, it is important to be properly seated and restrained to reduce the risk of death or serious injury.



Make sure the knee airbags are operating properly. See **Crash Sensors and Airbag Indicator** (page 67).

Airbags

HOW DOES THE SAFETY CANOPY™ WORK



WARNING: Do not place objects or mount equipment on or near the headliner at the siderail that may come into contact with a deploying curtain airbag. Failure to follow these instructions may increase the risk of personal injury in the event of a crash.



WARNING: Do not lean your head on the door. The curtain airbag could injure you as it deploys from the headliner.



WARNING: To reduce risk of injury, do not obstruct or place objects in the deployment path of the airbag.

The Safety Canopy deploys during significant side crashes or when a certain likelihood of a rollover event is detected by the rollover sensor. The Safety Canopy is mounted to the roof side-rail sheet metal, behind the headliner, above each row of seats. In certain sideways crashes or rollover events, the Safety Canopy will be activated, regardless of which seats are occupied. The Safety Canopy inflates between the side window area and occupants to further enhance protection provided in side impact crashes and rollover events.

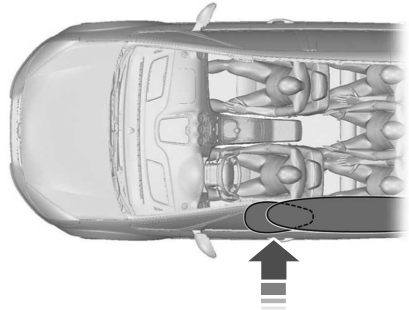

The system consists of the following:

- Safety Canopy curtain airbags above the trim panels over the front and rear side windows identified by a label or wording on the headliner or roof-pillar trim.
- A flexible headliner which opens above the side doors to allow air curtain deployment



• Crash sensors and monitoring system with a readiness indicator. See **Crash Sensors and Airbag Indicator** (page 67).

Properly restrain children 12 years old and under in the rear seats. The Safety Canopy will not interfere with children restrained using a properly installed child or booster seat because it is designed to inflate downward from the headliner above the doors along the side window opening.

AIRBAG PRECAUTIONS





WARNING: Airbags do not inflate slowly or gently, and the risk of injury from a deploying airbag is the greatest close to the trim covering the airbag module.

Airbags

 **WARNING:** All occupants of your vehicle, including the driver, should always properly wear their seatbelts, even when an airbag supplemental restraint system is provided. Failure to properly wear your seatbelt could seriously increase the risk of injury or death.

 **WARNING:** Properly secure children 12 years old and under in a rear seating position whenever possible. If you are unable to properly secure all children in a rear seating position, properly secure the largest child on the front seat. If you must use a forward facing child restraint on the front seat, move the seat as far back as possible. Failure to follow these instructions could result in personal injury or death.

 **WARNING:** Do not place your arms on the airbag cover or through the steering wheel. Failure to follow this instruction could result in personal injury.

 **WARNING:** Keep the areas in front of the airbags free from obstruction. Do not affix anything to or over the airbag covers. Objects could become projectiles during airbag deployment. Failure to follow this instruction could result in personal injury or death.

 **WARNING:** To reduce risk of injury, do not obstruct or place objects in the deployment path of the airbag.

 **WARNING:** Do not place a rearward facing child restraint in front of an active airbag. Failure to follow this instruction could result in personal injury or death.

 **WARNING:** Do not attempt to service, repair, or modify the supplementary restraint system or associated components. Failure to follow this instruction could result in personal injury or death.

 **WARNING:** Several airbag system components get hot after inflation. To reduce the risk of injury, do not touch them after inflation.

 **WARNING:** If a supplementary restraint system component has deployed, it will not function again. Have the system and associated components inspected as soon as possible. Failure to follow this instruction could result in personal injury or death.

PROPERLY ADJUSTING THE DRIVER AND FRONT PASSENGER SEATS

 **WARNING:** National Highway Traffic Safety Administration (NHTSA) recommends a minimum distance of at least 10 in (25 cm) between an occupant's chest and the driver airbag module.

To properly position yourself away from the airbag:

- Move your seat to the rear as far as you can while still reaching the pedals comfortably.
- Recline the seat slightly one or two degrees from the upright position.

Airbags

After all occupants have adjusted their seats and put on seatbelts, it is very important that they continue to sit properly. Properly seated occupants sit upright, lean against the seat backrest, and center themselves on the seat cushion, with their feet comfortably extended on the floor. Sitting improperly can increase the chance of injury in a crash event. For example, if an occupant slouches, lies down, turns sideways, sits forward, leans forward or sideways, or puts one or both feet up, the chance of injury during a crash greatly increases.

CHILDREN AND AIRBAGS



WARNING: Do not place a rearward facing child restraint in front of an active airbag. Failure to follow this instruction could result in personal injury or death.



Children must always be properly restrained. Accident statistics suggest that children are safer when properly restrained in the rear seating positions than in the front seating position. Failure to follow these instructions may increase the risk of injury in a crash.

FRONT PASSENGER SENSING SYSTEM

WHAT IS THE FRONT PASSENGER SENSING SYSTEM

This system detects a properly seated occupant and determines if the front passenger airbag should be enabled.

HOW DOES THE FRONT PASSENGER SENSING SYSTEM WORK

The system uses a passenger airbag status indicator which illuminates indicating that the front passenger frontal airbag is either enabled or disabled.

Note: When you first switch the ignition on, the passenger airbag status indicator off and on lamps illuminate for a short period to confirm they are functional.



The indicator lamps are on the center of the instrument panel.

The front passenger sensing system is designed to disable the front passenger frontal airbag under these conditions:

- The front passenger seat is unoccupied.
- The system determines an infant is present in a child restraint.

Airbags

- A passenger takes their weight off of the seat for a period of time.
- If there is a problem with the airbag system or the passenger sensing system.

Note: *Even with this technology, parents are strongly encouraged to always properly restrain children in the rear seat.*

- When the front passenger sensing system disables the front passenger frontal airbag, the passenger airbag status indicator illuminates the off lamp.
- If you have installed the child restraint, but the passenger airbag status indicator illuminates the on lamp, switch your vehicle off, remove the child restraint from your vehicle and reinstall the restraint following the child restraint manufacturer's instructions.

The front passenger sensing system works with sensors that are part of the front passenger seat and seatbelt. The sensors are designed to detect the presence of a properly seated occupant and determine if the front passenger frontal airbag should be enabled.

- When the front passenger sensing system enables the front passenger frontal airbag, the passenger airbag status indicator illuminates the on lamp.

If a person of adult size is sitting in the front passenger seat, but the passenger airbag status indicator off lamp is illuminated, it is possible that the person is not sitting properly in the seat. If this happens:

- Switch your vehicle off and ask the person to place the seat backrest in an upright position.
- Have the person sit upright in the seat, centered on the seat cushion, with the person's legs comfortably extended.

- Restart your vehicle and have the person remain in this position for about two minutes. This allows the system to detect that person and enable the passenger frontal airbag.
- If the indicator off lamp remains illuminated even after this, advise the person to ride in the rear seat.

After all occupants have adjusted their seats and put on seatbelts, it is very important that they continue to sit upright, leaning against the seat backrest, and centered on the seat cushion, with their feet comfortably extended on the floor.

Sitting improperly can increase the chance of injury in a crash event. For example, if an occupant slouches, lies down, turns sideways, sits forward, leans forward or sideways, or puts one or both feet up, the chance of injury during a crash greatly increases.

If you think that the state of the passenger airbag status indicator lamp is incorrect, check the following:

- Objects lodged underneath the seat.
- Objects between the seat cushion and the center console.
- Objects hanging off the seat backrest.
- Objects stowed in the seat backrest map pocket.
- Objects placed on the occupant's lap.
- Cargo interference with the seat
- Other passengers pushing or pulling on the seat.
- Rear passenger feet and knees resting or pushing on the seat.

The listed conditions could cause the weight of a properly seated occupant to be incorrectly interpreted by the front passenger sensing system. The person in the front passenger seat could appear heavier or lighter due to the conditions listed.

Airbags



Make sure the front passenger sensing system is operating properly. See **Crash Sensors and Airbag Indicator** (page 67).

If the airbag readiness light is on, do the following:

- Pull your vehicle over.
- Switch your vehicle off.
- Check for any objects lodged underneath the front passenger seat or cargo interfering with the seat.
- Remove the obstruction if found.
- Restart your vehicle.
- Wait at least two minutes and verify that the airbag readiness light in the instrument cluster is no longer illuminated.
- If the airbag readiness light in the instrument cluster remains illuminated, there may be a problem due to the front passenger sensing system.

Do not attempt to repair or service the system. Take your vehicle in for service immediately.

If it is necessary to modify an advanced front airbag system to accommodate a person with disabilities, contact your Customer Relationship Center.

FRONT PASSENGER SENSING SYSTEM PRECAUTIONS



WARNING: Sitting improperly, out of position or with the seatback reclined too far can take weight off the seat cushion and affect the decision of the passenger sensing system, resulting in serious injury or death in the event of a crash. Always sit upright against your seat back, with your feet on the floor.



WARNING: Any alteration or modification to the front passenger seat may affect the performance of the front passenger sensing system. This could seriously increase the risk of injury or death.



WARNING: Do not place objects under the front passenger seat or between the seat and the center console. Failure to follow this instruction may interfere with the front passenger seat sensing system and increase the risk of injury or death in a crash.



WARNING: Check the passenger airbag indicator lamp for proper airbag status. Failure to follow this instruction could result in personal injury or death.

FRONT PASSENGER SENSING SYSTEM INDICATORS

Occupant	Passenger Airbag Status Indicator	Passenger Airbag
Empty	OFF: Illuminated	Disabled
	ON: Not Illuminated	
Child	OFF: Illuminated	Disabled

Airbags

Occupant	Passenger Airbag Status Indicator	Passenger Airbag
	ON: Not Illuminated	
Adult	OFF: Not Illuminated	Enabled
	ON: Illuminated	

CRASH SENSORS AND AIRBAG INDICATOR



WARNING: Modifying or adding equipment to the front of your vehicle could affect the performance of the airbag system, increasing the risk of injury. This includes the hood, bumper system, frame, front body structure, tow hooks, hood pins, push bar and snowplows.

Your vehicle has a collection of crash and occupant sensors. These sensors provide information to the restraints control module which deploys the following:

- Seatbelt pretensioners.
- Driver airbag.
- Passenger airbag.
- Knee airbag(s).
- Seat mounted side airbags.
- Safety Canopy.

Based on the type of crash, the restraints control module deploys the appropriate safety devices.

The restraints control module also monitors the readiness of the above safety devices plus the crash and occupant sensors. The safety system displays an indicator in the instrument cluster when it is ready. The system sends out a tone if it is not working. The airbag does not require routine maintenance.

One or more of the following indicates a difficulty with the system:



The readiness light does not immediately illuminate after you switch the ignition on.

- The readiness light either flashes or stays on.
- You hear a series of five beeps. The tone pattern periodically repeats until the problem, the light or both are repaired.

If any of these things happen, even intermittently, have the supplemental restraint system serviced immediately at an authorized dealer. Unless serviced, the system may not properly function in the event of a crash.

The fact that the seatbelt pretensioners or front airbags did not activate for both front seat occupants in a crash does not mean that something is wrong with the system. Rather, it means the restraints control module determined the accident conditions (crash severity, seatbelt usage) were not appropriate to activate these safety devices.

- The design of the front airbags is to activate only in frontal and near-frontal crashes (not rollovers, side impacts or rear impacts) unless the crash causes sufficient frontal deceleration.
- The design of the front and rear seatbelt pretensioners is to activate in frontal, near-frontal and side crashes, and in rollovers.

Airbags

- The design of the knee airbag(s) is to deploy based on crash severity and occupant conditions.
- The design of the side airbags is to inflate in certain side impact crashes or rollover events. Side airbags may activate in other types of crashes if the vehicle experiences sufficient sideways motion or deformation.
- The design of the Safety Canopy is to inflate in certain side impact crashes or rollover events. The Safety Canopy may activate in other types of crashes if the vehicle experiences sufficient sideways motion or deformation, or a certain likelihood of rollover.

DISPOSING OF AIRBAGS

Contact your authorized dealer as soon as possible. Airbags must be disposed of by qualified personnel.

911 Assist

WHAT IS 911 ASSIST

911 Assist is a SYNC system feature that can call for help.

For more information, visit www.owner.ford.com.

HOW DOES 911 ASSIST WORK

If a crash deploys an airbag, excluding knee airbags and rear inflatable seatbelts, or activates the fuel pump shut-off, your vehicle may be able to contact emergency services by dialing 911 through a paired and connected **Bluetooth**® enabled phone.

Not all crashes deploy an airbag or activate the fuel pump shut-off. If a connected cell phone sustains damage or loses its connection to SYNC during a crash, SYNC searches for and tries to connect to a previously paired cell phone. SYNC then attempts to call the emergency services.

Before making the call:

- SYNC provides about 10 seconds to cancel the call. If you fail to cancel the call, SYNC attempts to dial 911.
- SYNC says the following, or a similar message: SYNC will attempt to call 911, to cancel the call, press Cancel on your screen or press and hold the phone button on your steering wheel.

If you do not cancel the call and SYNC makes a successful call a pre-recorded message plays for the 911 operator. The occupants in your vehicle are able to talk with the operator. Be prepared to provide your name, phone number and location immediately because not all 911 systems are capable of receiving this information electronically.

During an emergency call the system transmits vehicle data to the emergency service.

EMERGENCY CALL REQUIREMENTS



WARNING: Do not wait for 911 Assist to make an emergency call if you can do it yourself. Dial emergency services immediately to avoid delayed response time which could increase the risk of serious injury or death after a crash. If you do not hear 911 Assist within five seconds of the crash, the system or phone may be damaged or non-functional.



WARNING: Always place your phone in a secure location in your vehicle so it does not become a projectile or get damaged in a crash. Failure to do so may cause serious injury to someone or damage the phone which could prevent 911 Assist from working properly.



WARNING: Unless the 911 Assist setting is set on before a crash, the system will not dial for help which could delay response time, potentially increasing the risk of serious injury or death after a crash.

- SYNC is powered and working properly at the time of the incident and throughout feature activation and use.
- The 911 Assist feature must be set on before the incident.
- You must pair and connect a **Bluetooth**® enabled and compatible cell phone to SYNC.
- A connected **Bluetooth**® enabled phone must have the ability to make and maintain an outgoing call at the time of the incident.

911 Assist

- A connected **Bluetooth®** enabled phone must have adequate network coverage, battery power and signal strength.
- The vehicle must have battery power and be located in the U.S., Canada or in a territory in which 911 is the emergency number.

Note: *If any user sets 911 Assist to on or off, that setting applies for all paired phones. If 911 Assist is off and the phone connected to SYNC, an icon displays on the status bar.*

Note: *Every phone operates differently. While SYNC 911 Assist works with most cellular phones, some may have trouble using this feature.*

EMERGENCY CALL LIMITATIONS

The SYNC 911 Assist feature only operates in the U.S., Canada or in a territory in which 911 is the emergency number. The following are limitations of this feature:

- Your cellular phone or 911 Assist hardware sustains damage in a crash.
- The vehicle's battery or the SYNC system has no power.
- The phone(s) thrown from your vehicle are the ones paired and connected to the system.

Keys and Remote Controls

REMOTE CONTROL LIMITATIONS



WARNING: Changes or modifications not expressly approved by the party responsible for compliance could void the user's authority to operate the equipment. The term "IC:" before the radio certification number only signifies that Industry Canada technical specifications were met.

This device complies with Part 15 of the FCC Rules and with Industry Canada license-exempt RSS standard(s). Operation is subject to the following two conditions: (1) This device may not cause harmful interference, and (2) This device must accept any interference received, including interference that may cause undesired operation.

Make sure a valid remote control is within 3 ft (1 m) from the front door handles and rear of vehicle.

The system may not function if:

- The remote control remains stationary for about a minute.
- The vehicle battery has no charge.
- The remote control battery has no charge.
- There is interference causing issues with the remote control frequencies.
- The remote control is too close to metal objects or electronic devices, for example keys or a cell phone.

USING THE REMOTE CONTROL



WARNING: Do not leave a key or remote control unattended in the vehicle. Children or pets could operate the power windows, moonroof or other controls. Failure to follow this instruction could result in personal injury or death.

Use your remote control to access various vehicle systems.

Note: *The buttons on your remote may vary depending on the vehicle region or options.*

Unlock



Press the button to unlock all doors. See **Unlocking and Locking the Doors Using the Remote Control** (page 79).

Lock



Press the button to lock all doors. See **Unlocking and Locking the Doors Using the Remote Control** (page 79).

Remote Start (If Equipped)



Press the button within three seconds to remote start. See **Remotely Starting and Stopping the Vehicle** (page 135).

Panic Alarm (If Equipped)



Press the button to sound the panic alarm. See **Sounding the Panic Alarm** (page 72).

Keys and Remote Controls

OPENING AND CLOSING THE FLIP KEY

Opening Your Flip Key

Press the round button on the remote control to extend the flip key.

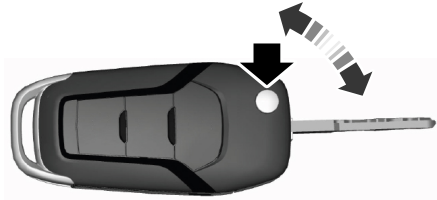

Note: Inspect the key blade for debris. Periodically clean with a brush.

Closing Your Flip Key

Press and hold the round button on the remote control to fold the key blade when not in use.

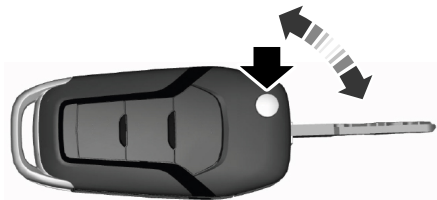

REMOVING THE KEY BLADE



Push the release button on your passive key and pull the key blade out.

SOUNDING THE PANIC ALARM



Press the button to sound the panic alarm. Press the button again or switch the ignition on to turn it off.

Note: The panic alarm only operates when the ignition is off.

LOCATING YOUR VEHICLE



Press the lock button twice within three seconds. The turn signal lamps flash.

Note: We recommend you use this method to locate your vehicle.

Keys and Remote Controls

CHANGING THE REMOTE CONTROL BATTERY - VEHICLES WITH: PUSH BUTTON START

⚠ WARNING: Keep batteries away from children to prevent ingestion. Failure to follow this instruction could result in personal injury or death. If ingested, immediately seek medical attention.

⚠ WARNING: If the battery compartment does not securely close, stop using the remote control and replace it as soon as possible. In the meantime, keep the remote control away from children. Failure to follow this instruction could result in personal injury or death.

The remote control uses one coin-type 3-volt lithium battery CR2450 or equivalent.



1. Push the release button and pull the key blade out.

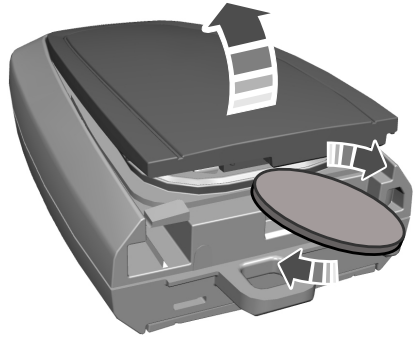
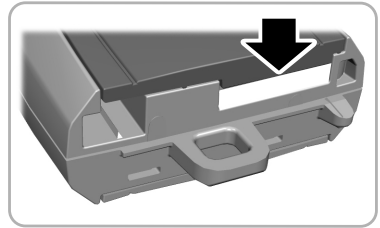

2. Twist a thin coin under the tab hidden behind the key blade head to remove the battery cover.

Keys and Remote Controls

CHANGING THE REMOTE CONTROL BATTERY - VEHICLES WITH: FLIP KEY

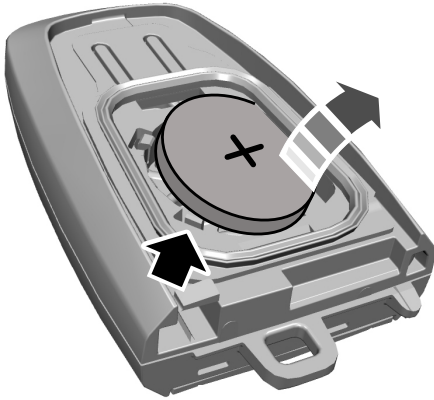

3. Insert a screwdriver, and carefully remove the battery.
4. Install a new battery with the + facing upward.
5. Reinstall the battery housing cover onto the transmitter and install the key blade.



Dispose of old batteries in an environmentally friendly way. Seek advice from your local authority about recycling old batteries.

Note: Do not wipe off any grease on the battery terminals or on the back surface of the circuit board.

Note: Replacing the battery does not erase the programmed key from your vehicle. The remote control should operate normally.

WARNING: Keep batteries away from children to prevent ingestion. Failure to follow this instruction could result in personal injury or death. If ingested, immediately seek medical attention.

WARNING: If the battery compartment does not securely close, stop using the remote control and replace it as soon as possible. In the meantime, keep the remote control away from children. Failure to follow this instruction could result in personal injury or death.

Battery Replacement Procedure

The remote control uses one coin-type 3-volt lithium battery CR2032 or equivalent.

Press the button to release the key blade before beginning the procedure.

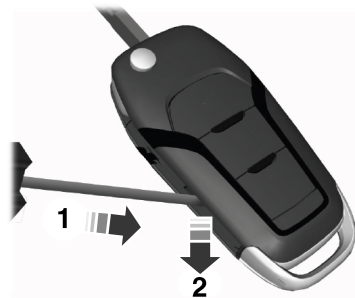

1. Insert a screwdriver, in the position shown and gently push the clip.
2. Press the clip down to release the battery cover.

Keys and Remote Controls

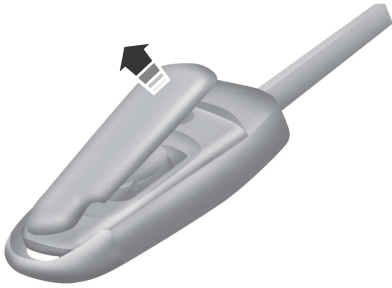

3. Carefully remove the cover.

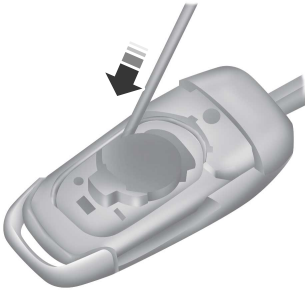

4. Insert a screwdriver as shown to release the battery.

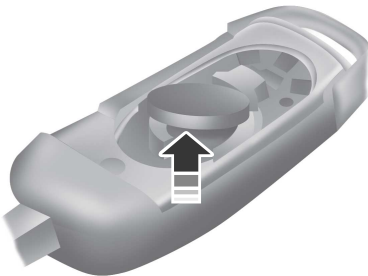

Note: Do not touch the battery contacts or the printed circuit board with the screwdriver.

5. Remove the battery.

6. Install a new battery with the + facing up.

7. Replace the battery cover.



Dispose of old batteries in an environmentally friendly way. Seek advice from your local authority about recycling old batteries.

Note: Do not wipe off any grease on the battery terminals or on the back surface of the circuit board.

Note: Replacing the battery does not erase the programmed key from your vehicle. The remote control should operate normally.

REPLACING A LOST KEY OR REMOTE CONTROL

You can purchase replacement keys or remote controls from an authorized dealer. Authorized dealers can program remote controls for your vehicle.



Note: Your vehicle keys came with a security label that provides important key cut information. Keep the label in a safe place for future reference.

Keys and Remote Controls

PROGRAMMING THE REMOTE CONTROL - VEHICLES WITH: PUSH BUTTON START

You must have two previously programmed remote controls inside your vehicle and the new, unprogrammed remote controls readily accessible. Contact an authorized dealer to have the spare remote control programmed if two previously programmed remote controls are not available. Make sure that your vehicle is off before beginning this procedure.

Make sure that you close all the doors before beginning and that they remain closed throughout the procedure. Perform all steps within 30 seconds of starting the sequence. Stop and wait for at least one minute before starting again if you perform any steps out of sequence.

Note: You can program a maximum of four remote controls to your vehicle.

Note: If your programmed remote controls get lost or stolen and you do not have an extra coded remote, you need to have your vehicle towed to an authorized dealer. Store an extra programmed remote away from your vehicle in a safe place to help prevent any inconvenience. Contact an authorized dealer to purchase additional spare or replacement remote controls.

Read and understand the entire procedure before you begin.

Programming Backup Location

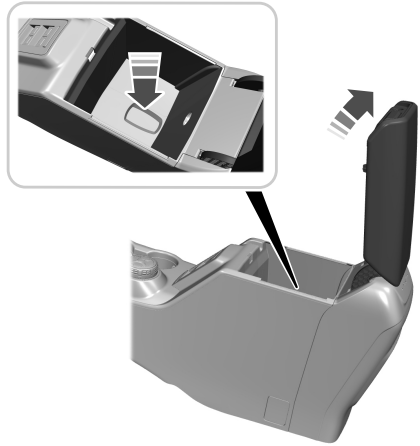

1. Place the first programmed remote in the backup slot inside the center console. With your foot off the brake pedal, press and release the push button ignition switch.
2. Wait five seconds and then press and release the push button ignition switch again.
3. Remove the remote control.
4. Within 10 seconds, place a second programmed remote control in the backup slot. Press and release the push button ignition switch.
5. Wait five seconds and then press and release the push button ignition switch again. Keep the ignition on for at least 3 seconds, but no more than 10 seconds.
6. Remove the remote control.
7. Place the unprogrammed remote control in the backup slot and press and release the push button ignition switch.

Keys and Remote Controls

Programming is now complete. With your foot on the brake pedal, press the push button ignition switch to verify the remote control functions operate and your vehicle starts with the new remote control.

If programming was not successful, wait 10 seconds and repeat Steps 1 through 7. If you are still unsuccessful, take your vehicle to an authorized dealer.

PROGRAMMING THE REMOTE CONTROL - VEHICLES WITH: FLIP KEY

General Information

You can program your own remote control to your vehicle. This procedure programs both the engine immobilizer keycode and the remote entry portion of the remote control to your vehicle.

Only use remote controls with an integrated mechanical key.

You must have two previously programmed coded remote controls and the new un-programmed remote readily accessible. Contact an authorized dealer to have the spare remote control programmed if the two previously programmed coded remote controls are not available.

Read and understand the entire procedure before you begin.

Steps for Programming Your Spare Remote Control

1. Insert the first previously programmed coded key into the ignition.
2. Switch the ignition from off to on. Keep the ignition on for at least three seconds, but no more than 10 seconds.
3. Switch the ignition off and remove the first coded key from the ignition.
4. After three seconds but within 10 seconds of switching the ignition off, insert the second previously coded key into the ignition.
5. Switch the ignition from off to on. Keep the ignition on for at least three seconds, but no more than 10 seconds.
6. Switch the ignition off and remove the second previously programmed coded key from the ignition.
7. After three seconds but within 10 seconds of switching the ignition off and removing the previously programmed coded key, insert the new un-programmed key into the ignition.
8. Switch the ignition from off to on. Keep the ignition on for at least six seconds until you hear the door locks cycle.
9. Remove the newly programmed coded key from the ignition.

The key starts the engine if programming is successful. You can operate the keyless remote entry system with the new remote control with integrated key.

If programming was not successful, wait 20 seconds and repeat Steps 1 through 8. If you are still unsuccessful, take your vehicle to an authorized dealer.

Note: *You can program a maximum of six coded remote controls to your vehicle.*

KEYS AND REMOTE CONTROLS AUDIBLE WARNINGS - VEHICLES WITH: PUSH BUTTON START

Key In Reminder

Sounds when the following conditions are met:

- Vehicle is out of park (P).
- You switch the vehicle off.

Keys and Remote Controls

- You open the driver's door.
- You have left the key inside the vehicle.

KEYS AND REMOTE CONTROLS AUDIBLE WARNINGS - VEHICLES WITH: FLIP KEY

Sounds when you open the driver's door, turn off the vehicle and you have left the key in the ignition.

KEYS AND REMOTE CONTROLS – TROUBLESHOOTING

KEYS AND REMOTE CONTROLS – INFORMATION MESSAGES

Message	Action
Key Battery Low Replace Soon	Replace remote control battery.

Doors and Locks

OPERATING THE DOORS FROM OUTSIDE YOUR VEHICLE

UNLOCKING AND LOCKING THE DOORS USING THE REMOTE CONTROL

You can only use the remote control when your vehicle is stationary.

Unlocking the Doors



Press the button to unlock all doors.

Locking the Doors



Press the button to lock all doors. One short flash of the turn signal lamps confirms that your vehicle has locked.

You can also use the remote control to lock or unlock the tailgate if your vehicle comes with a power tailgate lock. See **Locking and Unlocking the Tailgate** (page 85).

Note: For more information on operating the doors from outside your vehicle See **Keyless Entry** (page 83).

UNLOCKING AND LOCKING THE DOORS USING THE KEY BLADE

If there is a power door lock fault you can use the key blade to lock and unlock the doors.

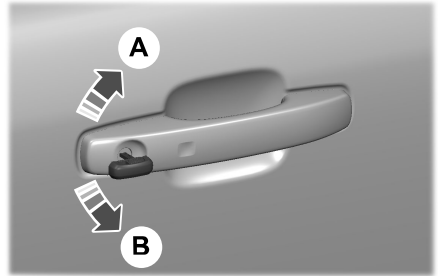

- A Lock.
- B Unlock.

OPERATING THE DOORS FROM INSIDE YOUR VEHICLE

UNLOCKING AND LOCKING THE DOORS USING THE CENTRAL LOCKING

The power door lock control is on the front doors.



Press the button to unlock all doors.



Press the button to lock all doors.

Note: The central locking only operates if the front doors are fully closed.

OPENING THE DOORS FROM INSIDE YOUR VEHICLE

Pull the interior door handle to unlock and open a door.

Doors and Locks

AUTOUNLOCK

WHAT IS AUTOUNLOCK

Autounlock is a feature that centrally unlocks the vehicle doors when your vehicle comes to a stop and you open the driver door.

AUTOUNLOCK REQUIREMENTS

Autounlock unlocks all the doors after:

1. The vehicle speed exceeds 12 mph (20 km/h).
2. Your vehicle comes to a stop.
3. You open the driver door.

Note: *Autounlock operates for only 10 minutes after the ignition is switched off.*

SWITCHING AUTOUNLOCK ON AND OFF

1.  Press the button on the touchscreen.
2. Press **Vehicle**.
3. Press **Locks**.
4. Switch **Autounlock** on or off.

AUTOLOCK

WHAT IS AUTOLOCK

Autolock is a locking feature that centrally locks your vehicle doors when driving.

AUTOLOCK REQUIREMENTS

Autolock locks all the doors after:

1. All doors are closed and the ignition is on.

2. Your vehicle speed exceeds 12 mph (20 km/h).

Autolock repeats if:

1. Your vehicle is stopped.
2. Any door is opened and closed again.
3. Your vehicle speed exceeds 12 mph (20 km/h).

MISLOCK

WHAT IS MISLOCK

Mislock is a locking feature that warns you if your vehicle has not locked.

MISLOCK LIMITATIONS

The turn signals will not flash when you press the lock button once and the hood or any door is open.

If you switch mislock off, the horn does not sound if you press the lock button on the remote control when a door is open.

SWITCHING MISLOCK ON AND OFF

1.  Press the button on the touchscreen.
2. Press **Vehicle**.
3. Press **Locks**.
4. Switch **Mislock** on or off.

Doors and Locks

AUTORELOCK

HOW DOES AUTORELOCK WORK

The doors automatically relock if you do not open a door within 45 seconds of unlocking the doors with the remote control. The door locks and the alarm return to their previous state.

DOOR LOCK INDICATORS

An LED on the power door lock control illuminates when all doors are locked. It remains on for up to five minutes after you switch the ignition off.

DOORS AND LOCKS AUDIBLE WARNINGS

Door Ajar Audible Warning

Sounds when any front door is not fully closed and your vehicle is moving.

DOORS AND LOCKS – TROUBLESHOOTING

DOORS AND LOCKS – WARNING LAMPS

Door Ajar Warning Lamp



Illuminates when you switch the ignition on and remains on if any door or the hood is open.

DOORS AND LOCKS – INFORMATION MESSAGES

Message	Details
Driver Door Ajar	Displays if a door is open. Fully close the door.
Passenger Door Ajar	
Rear Left Door Ajar	
Rear Right Door Ajar	
Hood Ajar	Displays if a hood is open. Fully close the hood.

Doors and Locks

DOORS AND LOCKS – FREQUENTLY ASKED QUESTIONS

Can accessories such as steps or handles be used with the latch assembly?

- Do not use the door latch assembly to attach any accessory, such as handles or steps, as this can cause damage to your vehicle.

Keyless Entry (If Equipped)

WHAT IS KEYLESS ENTRY

The system allows you to lock and unlock your vehicle without taking the passive key out of your pocket or purse.

KEYLESS ENTRY LIMITATIONS

Make sure your remote control is within 3 ft (1 m) from the front door handles and the tailgate.

The system could not function if:

- The remote control remains stationary for about a minute.
- The vehicle battery has no charge.
- The remote control battery has no charge.
- There is interference causing issues with the remote control frequencies.
- The remote control is too close to metal objects or electronic devices, for example keys or a cell phone.

KEYLESS ENTRY SETTINGS

Switching Keyless Entry On and Off

1. Press **Settings** on the touchscreen.
2. Press **Vehicle**.
3. Press **Locks**.
4. Switch **KeyFree** on or off.

USING KEYLESS ENTRY

Unlocking the Doors



With your passive key within 3 ft (1 m) of your vehicle, touch the unlock sensor on the back of the door handle for a brief period and then pull on the door handle to unlock, being careful not to touch the lock sensor at the same time or pull on the door handle too quickly. The intelligent access system requires a brief delay to authenticate your passive key.

Locking the Doors



With your passive key within 3 ft (1 m) of your vehicle, touch the outer door handle lock sensor for approximately one second to lock, being careful not to touch the unlock sensor on the back of the door handle at the same time. After locking, you can immediately pull on the door handle to confirm locking occurred without inadvertently unlocking.

KEYLESS ENTRY – TROUBLESHOOTING

KEYLESS ENTRY – FREQUENTLY ASKED QUESTIONS

Why does the keyless entry system not function?

If the system does not function it may be limited. See **Keyless Entry Limitations** (page 83). If the system still does not function use the remote control or the key blade to lock and unlock your vehicle.

Keyless Entry (If Equipped)

Why can I not lock my vehicle?

If you electronically lock your vehicle with a rear door or the liftgate open, the system searches for a passive key inside your vehicle after you close the last door. If the system detects a key, all doors unlock indicating that a key is inside. Your vehicle locks if another passive key is within the detection range after you close the last door.

Why does the passive key not work?

The system deactivates passive keys left inside your vehicle when you lock it. You cannot switch the ignition on using a deactivated passive key. Press the unlock button on the remote control to reactivate a passive key.

Tailgate

TAILGATE PRECAUTIONS



WARNING: It is extremely dangerous to ride in a cargo area, inside or outside of a vehicle. In a crash, people riding in these areas are more likely to be seriously injured or killed. Do not allow people to ride in any area of your vehicle that is not equipped with seats and seatbelts. Make sure everyone in your vehicle is in a seat and properly using a seatbelt. Failure to follow this warning could result in serious personal injury or death.

OPENING THE TAILGATE

OPENING THE TAILGATE FROM OUTSIDE YOUR VEHICLE

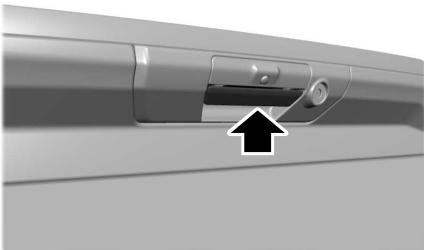

Pull up on the handle to release the tailgate.

Note: You may need to unlock the tailgate first.

LOCKING AND UNLOCKING THE TAILGATE

Manual

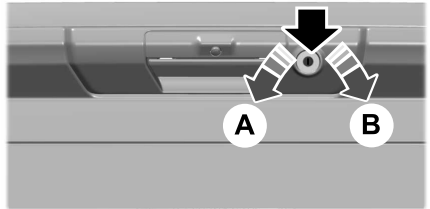

A Lock.

B Unlock.

1. Insert the ignition key into the tailgate lock.
2. Turn it to the left to lock the tailgate.
3. Turn it to the right to unlock the tailgate.

Power

You can lock and unlock the tailgate with the remote control or power door unlock control.

TAILGATE WORK SURFACE

The tailgate work surface is a durable and functional surface on the inside portion of your tailgate you can use to perform various tasks.

To use the tailgate work surface, fold down the tailgate.

Tailgate

Note: Ruler is subject to thermal variations with measurement errors of ± 0.2 in (5 mm).

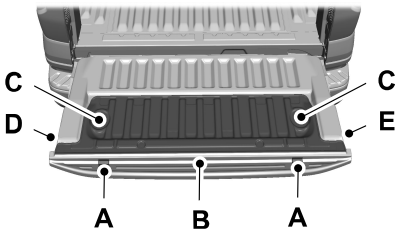

- A Clamp pocket.
- B Ruler.
- C Cup holder.
- D Bottle opener.
- E Bag holder.

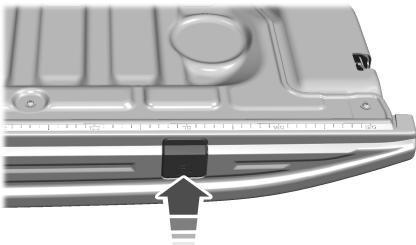

The tailgate work surface contains clamp pockets that allow you to secure work material.

Note: Damage could occur to the tailgate if the vertical clamp arm is overloaded in any direction.

Note: Do not put more than 10 kg in the bag holder.

Note: When you have finished using the tailgate work surface, make sure you remove all of your belongings from the tailgate, then close the tailgate.

Security

PASSIVE ANTI-THEFT SYSTEM

WHAT IS THE PASSIVE ANTI-THEFT SYSTEM

The passive anti-theft system prevents someone from starting your vehicle with an incorrectly coded key.

Note: *Do not leave a duplicate coded key in your vehicle. Always take the keys and lock all the doors when leaving your vehicle.*

HOW DOES THE PASSIVE ANTI-THEFT SYSTEM WORK

The passive anti-theft system arms when you switch the ignition off.

It disarms when you switch the ignition on with a correctly coded key.

Note: *The system is not compatible with non-Ford aftermarket remote start systems.*

Note: *Do not leave a duplicate coded key in your vehicle. Always take the keys and lock all doors when leaving your vehicle.*

ANTI-THEFT ALARM SYSTEM

WHAT IS THE ANTI-THEFT ALARM SYSTEM

The anti-theft alarm system warns you of an unauthorized entry to your vehicle.

HOW DOES THE ANTI-THEFT ALARM SYSTEM WORK

When armed, the anti-theft alarm is triggered in any of the following ways:

- If someone opens a door or the hood without a correctly coded key or remote control.
- If you turn the power on without a correctly coded key.
- If the interior sensors detect movement inside your vehicle.
- If the inclination sensors detect an attempt to raise your vehicle.
- If someone disconnects the vehicle battery or the battery backup alarm.

Any further attempts to carry out one of the above, sounds the alarm again.

If the anti-theft alarm is triggered, the alarm horn sounds for 30 seconds and the turn signals flash for five minutes.

WHAT IS THE PERIMETER ALARM

The perimeter alarm is designed to detect unauthorized access to your vehicle.

ARMING THE ANTI-THEFT ALARM SYSTEM

The alarm is ready to arm when you switch your vehicle off.

Lock your vehicle with your remote control to arm the alarm.

Security

DISARMING THE ANTI-THEFT ALARM SYSTEM

Disarm the alarm by performing any of the following actions:

- Unlock the doors or luggage compartment with the remote control.
- Switch your vehicle on or start your vehicle.

SECURITY – TROUBLESHOOTING

SECURITY – INFORMATION MESSAGES

Message	Details
No Key Detected	The system has not detected a correctly coded key.
Starting System Fault	The system has malfunctioned. Have your vehicle checked as soon as possible.
Vehicle Alarm To Stop Alarm, Start Vehicle.	Displays when the alarm has been triggered due to unauthorized entry.
Alarm	

Security

SECURITY – FREQUENTLY ASKED QUESTIONS

What should I do if there is a potential alarm problem with my vehicle?

- Take all remote controls to an authorized dealer if there is a potential alarm problem with your vehicle.

What should I do if my vehicle is unable to start with a correctly coded key?

- Have your vehicle checked as soon as possible.

Steering Wheel

ADJUSTING THE STEERING WHEEL

 **WARNING:** Do not adjust the steering wheel when your vehicle is moving.

Note: Make sure that you are sitting in the correct position. See **Sitting in the Correct Position** (page 144).

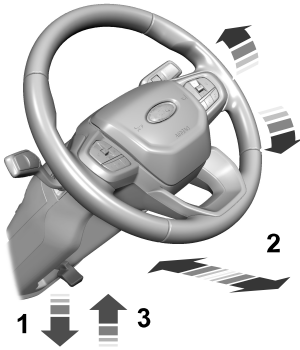

1. Unlock the steering column.
2. Adjust the steering wheel to the position you prefer.
3. Lock the steering column.

LOCKING THE STEERING WHEEL - VEHICLES WITHOUT: PUSH BUTTON START

1. Remove the key from the ignition.
2. Slightly rotate the steering wheel to engage the lock.

Unlocking the Steering Wheel

 **WARNING:** Always check that the steering is unlocked before attempting to move your vehicle.

1. Insert the key in the ignition.
2. Turn the key to position *I*.

Note: You may have to slightly rotate the steering wheel to assist unlocking it.

LOCKING THE STEERING WHEEL - VEHICLES WITH: PUSH BUTTON START

The steering wheel lock locks shortly after you have parked your vehicle and the passive key is outside it.

Note: The steering wheel lock does not lock when the ignition is on or when your vehicle is moving.

Unlocking the Steering Wheel

The steering wheel lock unlocks when the system detects a valid passive key inside your vehicle. If the steering wheel lock relocks, switch the ignition on to unlock it.

Note: You may have to slightly rotate the steering wheel to assist unlocking it.

HORN



Press on the center of the steering wheel near the horn icon to activate the horn.

Steering Wheel

SWITCHING THE HEATED STEERING WHEEL ON AND OFF



To activate the heated steering wheel, press the button on the touchscreen near the climate controls. The button illuminates when the heated steering wheel is on. To turn it off, press the heated steering wheel button again.

Note: *The engine must be running to use the heated steering wheel.*

Note: *A sensor regulates the temperature of the steering wheel.*

Note: *Depending on the remote start settings, the heated steering wheel may remain on after remote starting your vehicle. It may also turn on when you start your vehicle if it was on the last time the engine was switched off.*

Wipers and Washers

WIPERS

WIPER PRECAUTIONS

Do not operate the wipers on a dry windshield. This could scratch the glass or damage the wiper blades. Use the windshield washers before wiping a dry windshield.

Fully defrost the windshield before you switch the windshield wipers on.

Switch the windshield wipers off before entering a car wash.

Do not manually move the wiper arms for service activities.

Note: For vehicles with a service position, make sure the windshield wipers are in this position before proceeding. To place the wiper arms in a service position, switch your vehicle on in accessory mode, switch on the wipers and switch your vehicle off when the wipers are at their highest position.

SWITCHING WINDSHIELD WIPERS ON AND OFF

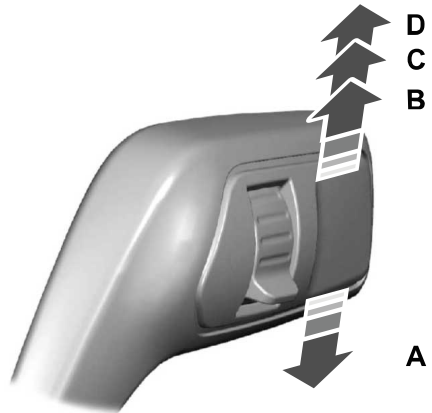

- A Single wipe.
- B Intermittent wipe/Auto wipe.
- C Normal wipe.
- D High-speed wipe.



Push the lever up or down to operate the windshield wipers.

AUTOWIPERS (IF EQUIPPED)

WHAT ARE AUTOWIPERS

Autowipers turns on and controls the speed and frequency of the windshield wipers.

Wipers and Washers

AUTOWIPERS SETTINGS

1.  Press the button on the touchscreen.
2. Press **Vehicle**.
3. Press **Wipers**.
4. Switch **Rain Sensing** on or off.

Note: When you switch the feature off, the wipers do not operate based on the rain sensor. When you switch on the windshield wipers to the intermittent wipe position with the feature off, the wipers use the wipe speed set by the rotary control.

ADJUSTING THE SENSITIVITY OF THE RAIN SENSOR

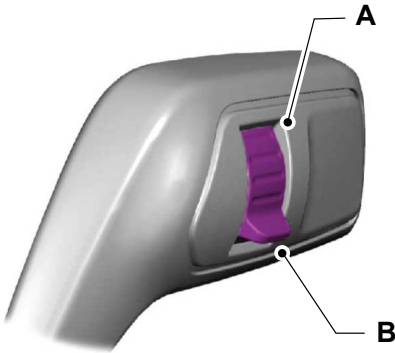

- A High sensitivity.
- B Low sensitivity.

Use the rotary control to set the rain sensor sensitivity.

When you select high sensitivity, the wipers operate when the sensor detects a small amount of water on the windshield.

When you select low sensitivity, the wipers operate when the sensor detects a large amount of water on the windshield.

CHECKING THE WIPER BLADES



Run the tip of your fingers over the edge of the blade to check for roughness.

REPLACING THE FRONT WIPER BLADES

Make sure your vehicle is off before beginning this procedure.

Note: Do not manually move the wiper arms. To place the wiper arms in a service position, switch your vehicle on in accessory mode, switch on the wipers and switch your vehicle off when the wipers are at their highest position.

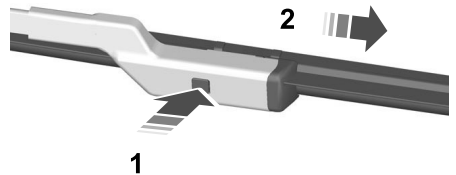

Wipers and Washers

1. Lift the wiper arm and then press the wiper blade locking button.

Note: Do not hold the wiper blade to lift the wiper arm.

2. Remove the wiper blade.

Note: Make sure that the wiper arm does not spring back against the glass when the wiper blade is not attached.

3. To install, reverse the removal procedure.

Note: Make sure that the wiper blade locks into place.

WASHERS

WASHER PRECAUTIONS



WARNING: If you operate your vehicle in temperatures below 41°F (5°C), use washer fluid with antifreeze protection. Failure to use washer fluid with antifreeze protection in cold weather could result in impaired windshield vision and increase the risk of injury or accident.

Do not operate the washers when the washer reservoir is empty. This could cause the washer pump to overheat.

Keep the outside of the windshield clean. The rain sensor is very sensitive and the wipers may operate if dirt, mist or insects hit the windshield.

USING THE WINDSHIELD WASHER



Pull the lever toward you to operate the windshield washer.

Note: A courtesy wipe occurs a short time after the wipers stop to clear any remaining washer fluid when switched on. See **Switching the Courtesy Wipe On and Off** (page 94).

SWITCHING THE COURTESY WIPE ON AND OFF

1.  Press the button on the touchscreen.
2. Press **Vehicle**.
3. Press **Wipers**.
4. Switch **Courtesy Wipe** on or off.

Note: When you switch the feature on, the wipers make an additional single wipe at the end of the washer request. When you switch it off, the wipers finish the current washer request.

Wipers and Washers

ADDING WASHER FLUID

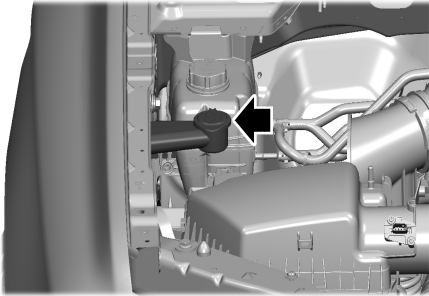

WASHER FLUID SPECIFICATION

See **Washer Fluid Specification** (page 487).

WIPERS AND WASHERS VIDEOS

[Improving Your Windshield Wiper Performance Video Link](#)

[Courtesy Wipe Video Link](#)

WIPERS AND WASHERS – TROUBLESHOOTING

WIPERS AND WASHERS – WARNING LAMPS



Illuminates when the windshield washer fluid is low.

WIPERS AND WASHERS – FREQUENTLY ASKED QUESTIONS

Why are there streaks and smears on the windshield?

- The wiper blades could be dirty, worn or damaged. Check the wiper blades. See **Checking the Wiper Blades** (page 93). If the wiper blades are dirty, clean them with washer fluid or water applied with a soft sponge or cloth. If the wiper blades are worn or damaged, install new ones. See **Replacing the Front Wiper Blades** (page 93).

Exterior Lighting

EXTERIOR LIGHTING CONTROL

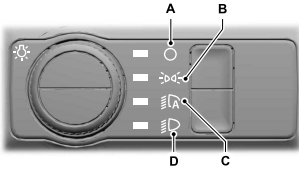

- A Lamps off.
- B Parking lamps on.
- C Autolamps on.
- D Headlamps on.

Rotate the control to make a selection.

Note: The lighting control defaults to autolamps every time you switch your vehicle on.

HEADLAMPS

USING THE HIGH BEAM HEADLAMPS

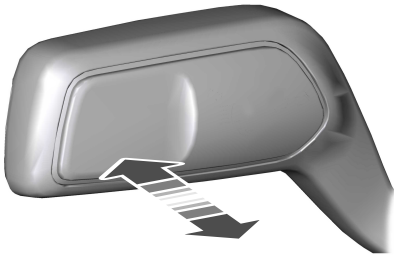

Push the lever away from you to switch the high beams on.

Push the lever forward again or pull the lever toward you to switch the high beams off.

Slightly pull the lever toward you and release it to flash the headlamps.

Note: Continuous activation only with headlamps on.

SWITCHING HEADLAMP EXIT DELAY ON AND OFF

To switch headlamp exit delay on, pull the turn signal lever toward you after switching your vehicle off.

To switch headlamp exit delay off, pull the turn signal lever toward you again or switch your vehicle on.

Note: The headlamps turn off after three minutes with any door open or 30 seconds after the last door closes.

ADJUSTING THE LEVEL OF THE HEADLAMPS (If Equipped)

Your vehicle has a dynamic leveling system. The headlamps do not require additional aim adjustment.

HEADLAMP INDICATORS

Lamps On



Illuminates when you switch the low beam headlamps or the parking lamps on.

Headlamp High Beam



Illuminates when you switch the high beam headlamps on.

Exterior Lighting

HEADLAMPS – TROUBLESHOOTING

HEADLAMPS – FREQUENTLY ASKED QUESTIONS

Why is there condensation in the headlamps?

- Headlamps have vents to accommodate normal changes in air pressure. Condensation can be a natural by-product of this design. When moist air enters the lamp assembly through the vents, there is a possibility that condensation can occur when the temperature is cold. When normal condensation occurs, a fine mist can form on the interior of the lens. The fine mist eventually clears and exits through the vents during normal operation.

How much condensation is acceptable?

- The presence of a fine mist, for example no streaks, drip marks or large droplets. A fine mist covers less than 50% of the lens.

How long does it take for the acceptable condensation to clear?

- Clearing time can take as long as 48 hours under dry weather conditions.

How much condensation is unacceptable?

- A water puddle inside the lamp. Streaks, drip marks or large droplets present on the interior of the lens.

What should I do if unacceptable condensation is present?

- Have your vehicle checked as soon as possible.

Why do my headlamps turn off when I have them switched on when I switch my vehicle off?

- The battery saver turns the headlamps off after a short period of time after you switch your vehicle off.

AUTOLAMPS

WHAT ARE AUTOLAMPS



WARNING: The system does not relieve you of your responsibility to drive with due care and attention. You may need to override the system if it does not turn the headlamps on in low visibility conditions, for example daytime fog.

Autolamps turn the headlamps on in low light situations or when the windshield wipers operate.

AUTOLAMP SETTINGS

To set the amount of time that the headlamps remain on after you switch your vehicle off:

1.  Press the button on the touchscreen.
2. Press **Vehicle**.
3. Press **Lighting**.
4. Press **Autolamp Delay**.
5. Press a setting.

Exterior Lighting

EXTERIOR LAMPS

USING THE TURN SIGNAL LAMPS



Push the lever up or down to switch the turn signal lamps on.

Set the lever to the middle position to switch the turn signal lamps off.

Note: Tap the lever up or down to make the turn signal lamps flash three times.

Turn Signal Lamp Indicator



It flashes when you switch the turn signal lamps on.

Note: An increase in the rate of flashing warns of a failed turn signal lamp.

SWITCHING THE DAYTIME RUNNING LAMPS ON AND OFF - VEHICLES WITH CONFIGURABLE DAYTIME RUNNING LAMPS



WARNING: The daytime running lamps system does not activate the rear lamps and may not provide adequate lighting during low visibility driving conditions. Make sure you switch the headlamps on, as appropriate, during all low visibility conditions. Failure to do so may result in a crash.

1.  Press the button on the touchscreen.
2. Press **Vehicle**.
3. Press **Lighting**.
4. Switch **Daytime Running Lights** on or off.

The daytime running lamps turn on when all of the following occur:

- You switch the system on.
- You switch the vehicle on.
- The transmission is not in park (P) for vehicles with automatic transmissions or you release the parking brake for vehicles with manual transmissions.
- The lighting control is in the autolamps position.
- The headlamps are off.

Note: Other lighting control positions do not turn on the daytime running lamps.

Exterior Lighting

SWITCHING THE DAYTIME RUNNING LAMPS ON AND OFF - VEHICLES WITH: DAYTIME RUNNING LAMPS (DRL)



WARNING: The daytime running lamps system does not activate the rear lamps and may not provide adequate lighting during low visibility driving conditions. Make sure you switch the headlamps on, as appropriate, during all low visibility conditions. Failure to do so may result in a crash.

Daytime running lamps are always on unless you switch on the headlamps or your vehicle is in park (P).

USING THE FRONT FOG LAMPS (If Equipped)

To switch the lamps on or off:

1. Set the lighting control to the parking lamps, headlamps or autolamps position.

Note: When the lighting control is in the autolamps position, you cannot switch the fog lamps on unless the low beam headlamps are on.

2.



Press the button on the lighting control to switch the front fog lamps on or off.

Note: Only switch the front fog lamps on during reduced visibility.

Note: The brightness of the daytime running lamps may decrease when the front fog lamps are switched on.

Note: The front fog lamps lights switch off automatically when high beams are activated.

Front Fog Lamps Indicator



It illuminates when you switch the front fog lamps on.

SWITCHING THE CARGO LAMPS ON

Pickup Bed Lamps



The pickup bed lamps turn on when opening any door.

Note: The cargo lamps turn off after a short period of time.

Using the Cargo Lamp Switch



Press the button on the lighting control to switch the lamps on and off.

Note: If the cargo lamps turned on automatically, this button does not turn them off.

Using the Roller Shutter

The cargo lamps switch on when you open the roller shutter.

Exterior Lighting

SWITCHING WELCOME LIGHTING ON AND OFF

Welcome lighting slowly turns on the exterior lamps when you approach your vehicle with an authenticated device or unlock the doors.

-  Press the button on the touchscreen.
- Press **Vehicle**.
- Press **Lighting**.
- Switch **Welcome Lighting** on or off.

EXTERIOR LAMP INDICATORS

Front Fog Lamp Indicator



It illuminates when you switch the front fog lamps on.

Rear Fog Lamp Indicator



It illuminates when you switch the rear fog lamps on.

Turn Signal Lamp Indicator



It flashes when you switch the turn signal lamps on.

Note: *An increase in the rate of flashing warns of a failed turn signal lamp.*

EXTERIOR LAMP INDICATORS

Front Fog Lamp



It illuminates when you switch the front fog lamps on.

Turn Signal Lamp



It flashes when you switch the turn signal lamps on.

Note: *An increase in the rate of flashing warns of a failed turn signal lamp.*

EXTERIOR LAMPS ON AUDIBLE WARNING

Exterior Lamps On

Sounds when you open the driver door and the lighting control is left in the parking lamps position and the ignition is off.

EXTERIOR ZONE LIGHTING

WHAT IS EXTERIOR ZONE LIGHTING

Exterior zone lighting divides the exterior lighting into zones and allows you to switch them on and off to provide lighting around the perimeter of your vehicle.

USING THE EXTERIOR ZONE LIGHTING

Depending on your vehicle software version, the zone lighting controls may be located in either the settings menu or the apps menu.

Apps menu:

-  Press the button on the touchscreen.
- Press **Zone Lighting**.

Settings menu:

-  Press the button on the touchscreen.

Exterior Lighting

2. Press **Zone Lighting**.

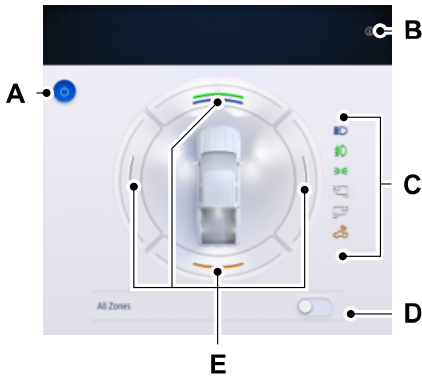

- A On and off button.
- B Contextual help.
- C Exterior lamp indicators.
- D All zones on and off.
- E Individual zones on and off.

You can use zone lighting when your vehicle is on or off. When your vehicle is off, the lighting switches off after a certain period of time to avoid draining the battery.

Note: You can also use individual zone controls to switch on each zone.

Note: Make sure to remove exterior lighting covers when using zone lighting.

Note: When your vehicle is off and the timer has one minute remaining, the turn signals flash six times.

Note: Indicators on the touchscreen illuminate when the lights outside of the zone lighting control are on.

Note: You can remotely control the zone lighting using the FordPass app.

Note: Vehicles without mirror puddle lamps only have two zones.

Zone Lighting Settings

Scroll down within the zone lighting application to access zone lighting settings.

Enable Autolamp Override

This setting allows the vehicle to override the autolamps when zone lighting is on.

When you access zone lighting for the first time, you can choose this setting. You can change this setting at any time.

Include Reverse Lamps

This setting turns the reverse lamps on when you switch the rear lighting zone on.

Switch this setting off if you have a backup alarm installed to prevent the reverse lamps from turning on and sounding the alarm when using zone lighting.

AUTOMATIC HIGH BEAM CONTROL

HOW DOES AUTOMATIC HIGH BEAM CONTROL WORK

Automatic high beam control turns the high beams on if it is dark enough and no other traffic is present. If it detects an approaching vehicle's headlamps or tail lamps, or street lighting ahead, the system turns the high beams off.

A camera sensor, centrally mounted behind the windshield of your vehicle, continuously monitors conditions to turn the high beams on and off.

Exterior Lighting

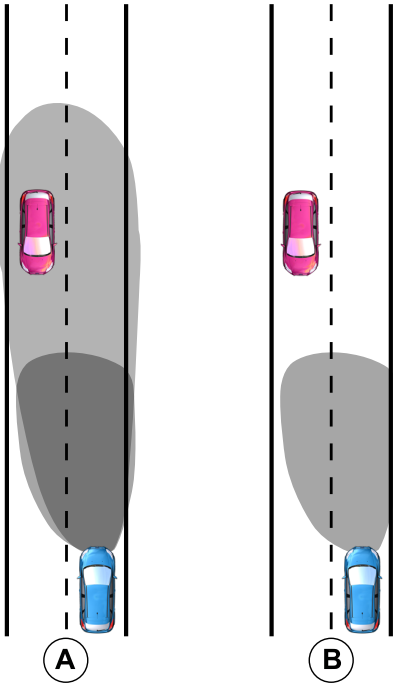

- A Without automatic high beam control.
- B With automatic high beam control.

AUTOMATIC HIGH BEAM CONTROL PRECAUTIONS

WARNING: The system does not relieve you of your responsibility to drive with due care and attention. You may need to override the system if it does not turn the high beams on or off.

WARNING: The system may not switch the high beams off if the lights of oncoming vehicles are hidden by obstacles, for example guard rails.

WARNING: You may need to override the system when approaching other road users.

WARNING: In situations with poor visibility, such as fog, heavy rain or other inclement weather, you may need to override or completely switch off the system.

AUTOMATIC HIGH BEAM CONTROL REQUIREMENTS

The system turns the high beams on if all of the following occur:

- You switch the system on.
- You set the lighting control to the autolamps position.
- The ambient light level is low enough that you require high beams.
- There is no traffic in front of your vehicle.
- The vehicle speed is greater than approximately 25 mph (40 km/h).

AUTOMATIC HIGH BEAM CONTROL LIMITATIONS

The system turns the high beams off if any of the following occur:

- You switch the system off.
- You set the lighting control to any position except autolamps.
- The ambient light level is high enough that you do not require high beams.
- The system detects an approaching vehicle's headlamps or a leading vehicle's tail lamps.

Exterior Lighting

- The system detects severe rain, snow, or fog.
- The system detects street lighting.
- The camera has reduced visibility.
- The vehicle speed is less than approximately 19 mph (30 km/h).

OVERRIDING AUTOMATIC HIGH BEAM CONTROL

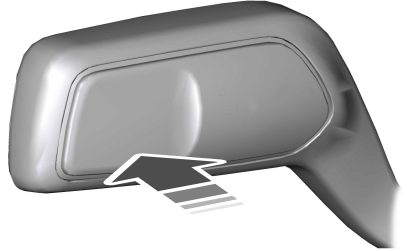

SWITCHING AUTOMATIC HIGH BEAM CONTROL ON AND OFF

1.  Press the button on the touchscreen.
2. Press **Vehicle**.
3. Press **Lighting**.
4. Switch **Auto High Beam** on or off.

Push the lever away from you to switch the high beams on.

Push the lever away from you again to switch the high beams off.

Push the lever away from you for a third time to switch automatic high beam control back on.

AUTOMATIC HIGH BEAM CONTROL INDICATORS



Illuminates to confirm when the system is ready to assist.

AUTOMATIC HIGH BEAM CONTROL – TROUBLESHOOTING

AUTOMATIC HIGH BEAM CONTROL – INFORMATION MESSAGES

Message	Details
Front Camera Low Visibility Clean Screen	The camera has reduced visibility. Clean the windshield. If the message continues to appear, have your vehicle checked as soon as possible.
Front Camera Temporarily Not Available	The camera has malfunctioned. Wait a short period of time for the camera to cool down. If the message continues to appear, have your vehicle checked as soon as possible.
Front Camera Malfunction Service Required	The camera has malfunctioned. Have your vehicle checked as soon as possible.

Exterior Lighting

ADAPTIVE FRONT LIGHTING (IF EQUIPPED)

HOW DOES ADAPTIVE FRONT LIGHTING WORK

Dynamic Bending Lamps (If Equipped)



WARNING: Inspect and replace the windshield wiper blades regularly to make sure the camera sensor has a clear view. The windshield wiper blades must be the correct length.

Uses steering wheel and vehicle speed input to adjust the headlamps.

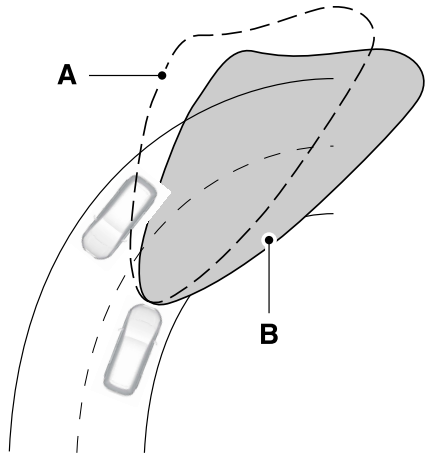

- A Without dynamic bending lamps.
- B With dynamic bending lamps.

Static Bending Lamps (If Equipped)

Illuminates the inside of a corner when you are turning the steering wheel.

Exterior Lighting

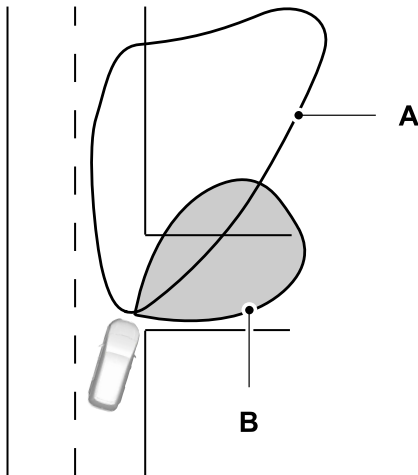

- A Headlamp beam.
- B Static bending lamp beam.

Note: Depending on the angle of the steering wheel, the brightness and activation of the feature may vary.

Cornering Lamps (If Equipped)

Illuminates the inside of a corner when you are turning the steering wheel or when you switch the turn signal lamps on. They turn on when the vehicle speed is below 24.9 mph (40 km/h).

Note: Only the cornering lamp located on the side where your vehicle is turning illuminates.

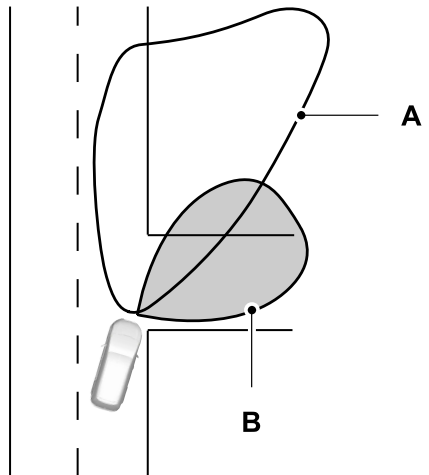

- A Headlamp beam.
- B Cornering lamp beam.

SWITCHING ADAPTIVE FRONT LIGHTING ON AND OFF

1.  Press the button on the touchscreen.
 2. Press **Vehicle**.
 3. Press **Lighting**.
 4. Switch **Adaptive Headlamps** on or off.
- Set the lighting control to the autolamps position or the low beams position to use the adaptive front lighting.

Interior Lighting

SWITCHING ALL OF THE INTERIOR LAMPS ON AND OFF

Switching All of the Interior Lamps On



Press the button on the overhead console toward the icon.

Switching All of the Interior Lamps Off



Press the button on the overhead console toward the icon.

SWITCHING THE FRONT INTERIOR LAMPS ON AND OFF



Press the edge of the lamp lens.

SWITCHING THE REAR INTERIOR LAMPS ON AND OFF

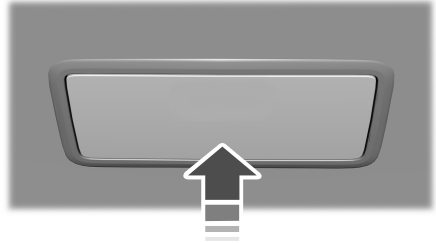

Press the lens to switch the lamps on or off.

Note: If you switch the rear lamps on through the overhead console, you cannot switch them off with the rear lamp switch.

INTERIOR LAMP FUNCTION

WHAT IS THE INTERIOR LAMP FUNCTION

The interior lamp function switches the courtesy and door lamps on or off.

SWITCHING THE INTERIOR LAMP FUNCTION ON AND OFF

The switch is on the overhead console.



Set the switch to the middle position.

Interior Lighting

When you switch the interior lamp function on, the interior lamps turn on if:

- You open a door.
- You press the unlock button on the remote control.
- You switch the ignition off.

ADJUSTING THE INSTRUMENT PANEL LIGHTING BRIGHTNESS

The instrument lighting dimmer buttons are on the lighting control.



Repeatedly press one of the buttons to adjust the brightness.



AMBIENT LIGHTING (IF EQUIPPED)

SWITCHING AMBIENT LIGHTING ON AND OFF

1.  Press the button on the touchscreen.
2. Press **General**.
3. Press **Ambient Light**.
4. Switch **Ambient Light** on or off.

ADJUSTING AMBIENT LIGHTING

Drag the slider left or right.

INTERIOR LIGHTING – TROUBLESHOOTING

INTERIOR LIGHTING – FREQUENTLY ASKED QUESTIONS

Why do my courtesy lamps or interior lamps turn off when I have them switched on when I switch my vehicle off?

- The battery saver turns the courtesy lamps and interior lamps off after a short period of time after you switch your vehicle off.

Windows

OPENING AND CLOSING THE WINDOWS



WARNING: Do not leave children or pets unattended in your vehicle and do not let children play with the power windows. Failure to follow this instruction could result in personal injury or death.



WARNING: When closing the power windows, verify that they are free of obstructions and make sure children and pets are not in the proximity of the window openings. Failure to follow this instruction could result in personal injury or death.



WARNING: If an obstruction is detected, release the switch and reverse the window immediately. Failure to follow this instruction could result in personal injury or death.



WARNING: Do not leave a key or remote control unattended in the vehicle. Children or pets could operate the power windows and could become trapped in a closing window. Failure to follow this instruction could result in personal injury or death.



Press the window control switch to open the window. Lift the window control switch to close the window.

Note: The power windows operate with the ignition on, and for several minutes after you switch the ignition off or until you open a front door.

To reduce wind noise or pulsing noise when one window is open, slightly open the opposite window.

One-Touch Open

Fully press the window control switch and release it. Press again or lift it to stop the window.

One-Touch Close

Fully lift the window control switch and release it. Press again or lift it to stop the window.

Resetting One-Touch Close

Carry out all steps within 30 seconds of starting the sequence.

1. Close the window.
2. Press and hold the window control switch until the window is fully open. Keep the window control switch pressed for a few seconds.
3. Lift and hold the window control switch until the window is fully closed. Keep the window control switch held for a few seconds.
4. Press and hold the window control switch until the window is fully open. Keep the window control switch pressed for a few seconds.
5. Lift and hold the window control switch until the window is fully closed. Keep the window control switch held for a few seconds.

Note: Repeat the procedure if the window does not close when you use one-touch.

GLOBAL OPENING AND CLOSING

WHAT IS GLOBAL OPENING AND CLOSING

You can use the remote control to operate the windows with the ignition off.

Windows

USING GLOBAL OPENING

1. Press and release the unlock button on the remote control.
2. Within one second, press and hold the unlock button on the remote control.
3. Release the button when the windows start to open.

Press the lock or the unlock button on the remote control to stop global opening.

Note: *Global opening will only respond to a press and hold of the unlock button for a short period of time after the unlock button is pressed on the remote control.*

SWITCHING GLOBAL OPENING ON AND OFF

1.  Press the button on the touchscreen.
2. Press **Vehicle**.
3. Press **Windows**.
4. Switch **Remote Open** on or off.

USING GLOBAL CLOSING



WARNING: When closing the power windows, verify that they are free of obstructions and make sure children and pets are not in the proximity of the window openings. Failure to follow this instruction could result in personal injury or death.

1. Press and hold the lock button on the remote control.
2. Release the button when the windows start to close.

Press the lock or the unlock button on the remote control to stop global closing.

Note: *Bounce-back is on during global closing. See **What Is Window Bounce-Back** (page 109).*

SWITCHING GLOBAL CLOSING ON AND OFF

1.  Press the button on the touchscreen.
2. Press **Vehicle**.
3. Press **Windows**.
4. Switch **Remote Close** on or off.

WINDOW BOUNCE-BACK

WHAT IS WINDOW BOUNCE-BACK

The window stops and reverses if it detects an obstruction when closing.

OVERRIDING WINDOW BOUNCE-BACK



WARNING: If you override bounce-back, the window does not reverse if it detects an obstacle. Take care when closing the windows to avoid personal injury or damage to your vehicle.

1. Close the window until it reaches the point of resistance and let it reverse.
2. Lift and hold the window control switch within two seconds to override bounce-back and close the window. Bounce-back is now disabled and you can close the window manually.

Note: *The window goes past the point of resistance and you can fully close it.*

Note: *If the window does not close, have your vehicle checked as soon as possible.*

Windows

LOCKING THE REAR WINDOW CONTROLS



WARNING: When children are in the rear seat, use the power window lockout button to prevent accidental operation of the power windows.



Press the window control switch to lock or unlock the rear window controls. It illuminates when you lock the rear window controls.

OPENING AND CLOSING THE SLIDING WINDOWS



WARNING: Do not leave children or pets unattended in your vehicle and do not let children play with the power windows. Failure to follow this instruction could result in personal injury or death.



WARNING: When closing the power windows, verify that they are free of obstructions and make sure children and pets are not in the proximity of the window openings. Failure to follow this instruction could result in personal injury or death.



WARNING: If an obstruction is detected, release the switch and reverse the window immediately. Failure to follow this instruction could result in personal injury or death.



WARNING: Do not leave a key or remote control unattended in the vehicle. Children or pets could operate the power windows and could become trapped in a closing window. Failure to follow this instruction could result in personal injury or death.

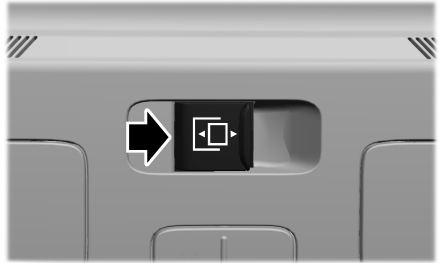

The window control switch is on the overhead console.

Press and hold the window control switch to open the window. Pull and hold the window control switch to close the window.

Interior Mirror

INTERIOR MIRROR PRECAUTIONS



WARNING: Do not adjust the mirrors when your vehicle is moving. This could result in the loss of control of your vehicle, serious personal injury or death.

Note: Do not clean the mirror housing or glass with harsh abrasives, fuel or other petroleum-based cleaning products.

MANUALLY DIMMING THE INTERIOR MIRROR

Pull the tab below the mirror toward you to reduce glare at night.

AUTO-DIMMING INTERIOR MIRROR (IF EQUIPPED)

WHAT IS THE AUTO-DIMMING INTERIOR MIRROR

The mirror dims to reduce the effect of bright light from behind. It returns to normal when the bright light from behind is no longer present or if you shift into reverse (R), to make sure you have a clear view when backing up.

AUTO-DIMMING INTERIOR MIRROR LIMITATIONS

Do not block the sensors on the front and back of the mirror.

Note: A rear center passenger or raised rear center head restraint could prevent light from reaching the sensor.

Exterior Mirrors

ADJUSTING THE EXTERIOR MIRRORS



WARNING: Do not adjust the mirrors when your vehicle is moving. This could result in the loss of control of your vehicle, serious personal injury or death.

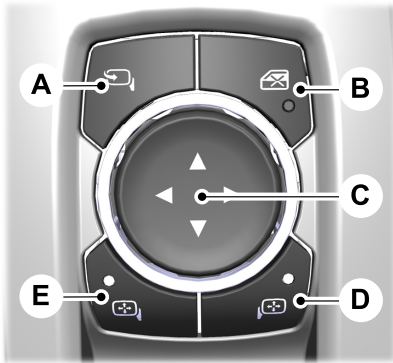

- A Power fold.
- B Window lock.
- C Adjustment control.
- D Right-hand mirror.
- E Left-hand mirror.

To adjust the mirrors, switch your vehicle on and place the ignition in accessory or start.

1. Select the mirror you want to adjust. The control light turns on.
2. Use the adjustment control to adjust the position of the mirror.
3. Press the mirror control again. The control light turns off.

FOLDING THE EXTERIOR MIRRORS - VEHICLES WITH: MANUAL FOLDING MIRRORS

Push the mirror toward the door window glass. Make sure that you fully engage the mirror in its support when returning it to its original position.

Directional Indicator Mirrors

When your vehicle is running, the forward-facing portion of the appropriate mirror housing blinks when you switch on the turn signal.

Puddle Lamps (If Equipped)

The puddle lamps turn on when you approach your vehicle with a remote control or phone. If your vehicle has auto-folding mirrors, the puddle lamps are only on if the mirrors are unfolded and turn off when the mirrors fold.

Heated Exterior Mirrors (If Equipped)

360 Degree Camera (If Equipped)

See **Locating the 360 Degree Cameras** (page 251).

Blind Spot Information System (If Equipped)

See **What Is Blind Spot Information System** (page 301).

FOLDING THE EXTERIOR MIRRORS - VEHICLES WITH: POWER FOLDING MIRRORS (IF EQUIPPED)

The exterior mirrors fold when you lock your vehicle and unfold when you unlock your vehicle.

Exterior Mirrors

Note: This feature requires you to switch the exterior mirrors auto fold on.



For tight parking conditions, press the control to fold the mirrors.

Press the control switch again to unfold the mirrors.

Note: Do not stop the mirrors midway through their movement. Wait until the mirrors stop moving and press the control again.

The left-hand and right-hand mirrors move at different rates. For example, one mirror may stop while the other one continues to move. This is normal.

If you press the control switch to fold the mirrors with auto fold on, the mirrors do not unfold when you unlock your vehicle.

Note: The power folding mirrors operate with the vehicle on, and for several minutes after you switch the vehicle off.

Note: If you fold and unfold the mirrors several times within one minute, the power fold function may turn off to protect the motors from overheating.

Switching Auto fold On and Off

1. Press **Settings** on the touchscreen.
2. Press **Vehicle Settings**.
3. Press **Mirrors**.
4. Switch **Autofold** on or off.

Loose Mirror

If your power folding mirrors are manually folded, they may not work properly even after you reposition them. You need to reset them if:

- The mirrors vibrate when you drive.
- The mirrors feel loose.

- The mirrors do not stay in the folded or unfolded position.
- One of the mirrors is not in its normal driving position.

To reset the mirrors perform the following steps:

1. Fold or retract both mirrors manually.
2. Using the power folding/power telescoping mirror control switch, operate the mirrors until you hear an audible click.
3. Operate the power folding or power telescoping mirrors an additional 3 to 4 times to synchronize the mirrors.

AUTO-DIMMING EXTERIOR MIRROR (IF EQUIPPED)

WHAT IS THE AUTO-DIMMING EXTERIOR MIRROR

The driver exterior mirror dims when the interior auto-dimming mirror turns on.

Moonroof (If Equipped)

OPENING AND CLOSING THE SUNSHADE

 **WARNING:** Do not leave children or pets unattended in your vehicle and do not let children play with the sunshade. Failure to follow this instruction could result in personal injury.

The sliding sunshade can be manually opened or closed when the moonroof is closed. Pull the sunshade toward the front of the vehicle to close it.

OPENING AND CLOSING THE MOONROOF

 **WARNING:** Do not leave children or pets unattended in your vehicle and do not let children play with the moonroof. Failure to follow this instruction could result in personal injury or death.

 **WARNING:** Do not leave a key or remote control unattended in the vehicle. Children or pets could operate the moonroof and could become trapped in a closing moonroof. Failure to follow this instruction could result in personal injury or death.

The moonroof controls are located on the overhead console and have a one-touch open and close feature. To stop its movement during one-touch operation, press the control a second time.

Opening the Moonroof



Press and release the switch to activate the one-touch open feature. To stop movement, press the switch a second time.

Closing the Moonroof

 **WARNING:** When closing the moonroof, verify that it is free of obstructions and make sure children and pets are not in the proximity of the moonroof. Failure to follow this instruction could result in personal injury or death.

 **WARNING:** If an obstruction is detected, release the switch and reverse the moonroof immediately. Failure to follow this instruction could result in personal injury or death.



Press and release the switch to activate the one-touch close feature, from either the open or vent positions. To stop movement, press the switch a second time.

VENTING THE MOONROOF

 **WARNING:** Do not leave children unattended in your vehicle and do not let them play with the moonroof. Failure to follow this instruction could result in personal injury.

 **WARNING:** When closing the moonroof, verify that it is free of obstruction and make sure that children and pets are not in the proximity of the roof opening.

The moonroof controls are on the overhead console.



With the moonroof in the closed position, press and release the switch to vent the moonroof. To close the moonroof from the vent position, press and release the switch again.

Moonroof (If Equipped)

MOONROOF BOUNCE-BACK

WHAT IS MOONROOF BOUNCE-BACK

The moonroof stops and reverses some distance if it detects an obstacle when closing.

OVERRIDING MOONROOF BOUNCE-BACK

Press and hold the close switch within two seconds after the moonroof comes to a stop.

Instrument Cluster

INSTRUMENT CLUSTER OVERVIEW - VEHICLES WITH: 8 INCH SCREEN

Note: Depending on the setting you select, your cluster could look different than what you see here.

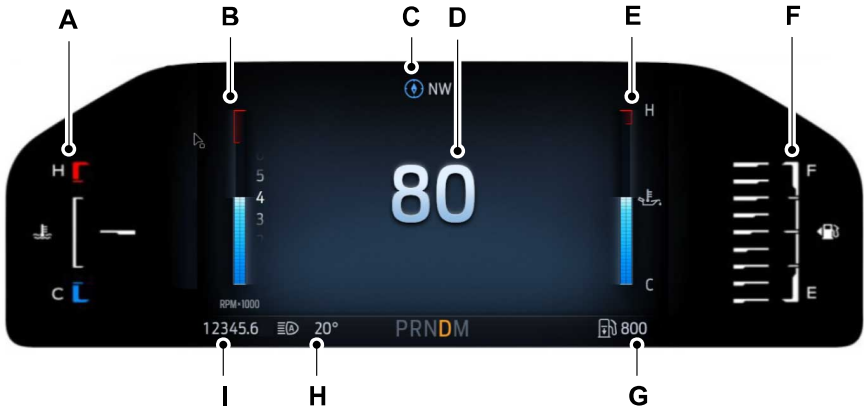

- A Engine coolant temperature gauge.
- B Tachometer.
- C Compass.
- D Speedometer.
- E Engine oil temperature.
- F Fuel gauge.
- G Distance to empty.
- H Outside air temperature.
- I Odometer.

Note: The tachometer and engine oil temperature gauge can be configured on or off.

INSTRUMENT CLUSTER OVERVIEW - VEHICLES WITH: 12 INCH SCREEN

Note: Depending on the setting you select, your cluster could look different than what you see here.

Instrument Cluster

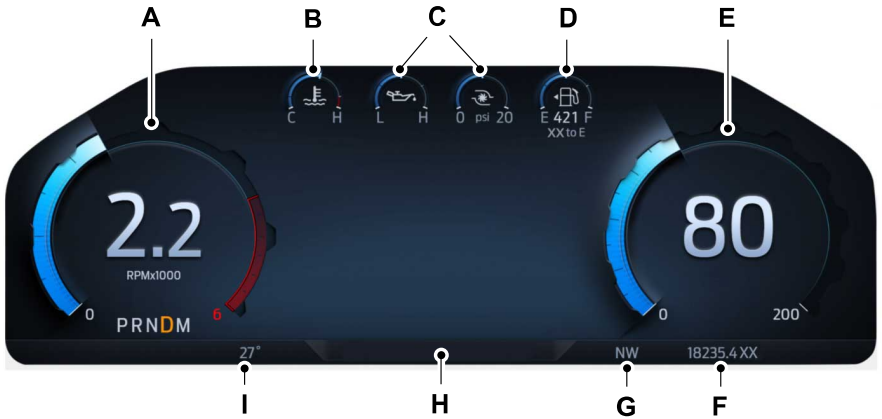

- A Tachometer.
- B Engine coolant temperature gauge.
- C Configurable gauges.
- D Fuel gauge.
- E Speedometer.
- F Odometer.
- G Compass.
- H Information bar.
- I Ambient temperature.

TACHOMETER

Indicates the engine speed.

The red line indicates the point at which engine revolutions could become limited to avoid over-revving the engine.

SPEEDOMETER

Indicates the vehicle speed.

Secondary Speedometer

You can select a secondary speedometer that displays other measurement units.

Note: When only the primary speedometer is shown, the units are the same as the trip distance units selected. See **Changing the Measurement Unit** (page 133).

Instrument Cluster

FUEL GAUGE

WHAT IS THE FUEL GAUGE

Indicates approximately how much fuel is in the fuel tank.

FUEL GAUGE LIMITATIONS

The fuel gauge may not provide an accurate reading when your vehicle is on an incline.

LOCATING THE FUEL FILLER DOOR

The arrow adjacent to the fuel pump symbol indicates on which side of your vehicle the fuel filler door is located.

WHAT IS THE LOW FUEL REMINDER

A low fuel level reminder displays and sounds when the distance to empty reaches 50 mi (80 km), 25 mi (40 km), 10 mi (20 km) and 0 mi (0 km).

Note: *The low fuel reminder can appear at different fuel gauge positions depending on fuel economy conditions. This variation is normal.*

WHAT IS DISTANCE TO EMPTY

Indicates the approximate distance your vehicle can travel on the fuel remaining in the tank. Changes in driving pattern can cause the value to not only decrease but also increase or stay constant for periods of time.

ENGINE COOLANT TEMPERATURE GAUGE

Indicates the engine coolant temperature. See **Checking the Coolant Level** (page 408).

ENGINE OIL PRESSURE GAUGE - VEHICLES WITH: 8 INCH SCREEN (IF EQUIPPED)

Indicates the engine oil pressure. The gauge turns red when the oil pressure warning lamp illuminates.

This gauge is available in an information on demand screen. See **Instrument Cluster Display Main Menu** (page 126).

ENGINE OIL PRESSURE GAUGE - VEHICLES WITH: 12 INCH SCREEN (IF EQUIPPED)

Indicates the engine oil pressure. The gauge turns red when the oil pressure warning lamp illuminates.

Note: *This is a configurable gauge.*

TRANSMISSION FLUID TEMPERATURE GAUGE - VEHICLES WITH: 8 INCH SCREEN

Indicates the transmission fluid temperature.

Note: *Special operating conditions such as snowplowing, towing or off-road use can cause higher than normal operating temperatures.*

This gauge is available in an information on demand screen. See **Instrument Cluster Display Main Menu** (page 126).

Instrument Cluster

TRANSMISSION FLUID TEMPERATURE GAUGE - VEHICLES WITH: 12 INCH SCREEN

Indicates the transmission fluid temperature.

Note: *Special operating conditions such as snowplowing, towing or off-road use can cause higher than normal operating temperatures.*

Note: *This is a configurable gauge.*

WHAT ARE THE INSTRUMENT CLUSTER WARNING LAMPS

Warning lamps alert you to a vehicle condition that could become serious. Some lamps illuminate when you start your vehicle to make sure they work. If any lamps remain on after starting your vehicle, refer to the respective system warning lamp for further information.

INSTRUMENT CLUSTER WARNING LAMPS

Depending on your vehicle options and instrument cluster type, not all warning lamps shown are available.

Airbags



See **Airbags** (page 60).

Anti-Lock Brake System



If it illuminates when you are driving, this indicates a malfunction. Your vehicle continues to have normal braking without the anti-lock brake system function. Have your vehicle checked as soon as possible.

Battery



Illuminates when you switch the ignition on.

If it illuminates when the engine is running, this indicates your vehicle requires service. Have your vehicle checked as soon as possible.

Brake System



Illuminates red when you apply the parking brake and the ignition is on. If it illuminates when your vehicle is moving, make sure the parking brake is released. If the parking brake is released, this indicates low brake fluid level or the brake system requires service. Have your vehicle checked as soon as possible.

Note: *Indicators may vary depending on region.*

Door Ajar



Illuminates when you switch the ignition on and remains on if any door is open.

Electric Park Brake



Illuminates yellow or flashes when the electric parking brake requires service.

Note: *Indicators may vary depending on region.*

Engine Coolant Temperature



If it illuminates, safely stop your vehicle and switch the vehicle off.

Instrument Cluster

Fasten Seatbelt



Illuminates and a tone sounds until you fasten the seatbelts.

Hood Ajar



Illuminates when the ignition is on and the hood is not completely closed.

Low Beam Warning



Illuminates when there is a malfunction with the LED low beam headlamp.

Low Fuel Level



Illuminates when the fuel level is low.

Low Tire Pressure



Illuminates when your tire pressure is low. If illuminated, check your tire pressure as soon as possible. If it begins to flash at anytime, have the system checked as soon as possible.

Low Washer Fluid Level



Illuminates when the washer fluid is low.

Malfunction Indicator Lamp



Illuminates when the ignition is on and the engine is off, this is normal. If it illuminates when the engine is on this indicates the emission control system requires service. If it flashes, have your vehicle checked immediately. See **Emission Law** (page 608). See **Starting and Stopping the Engine – Warning Lamps** (page 176).

Oil Pressure



WARNING: If it illuminates when you are driving do not continue your journey, even if the oil level is correct. Have your vehicle checked.



Illuminates when the engine oil pressure is low.

Over Speed Warning



Illuminates if the vehicle speed exceeds the over speed threshold.

Over speed thresholds vary depending on region.

Powertrain Malfunction, Reduced Power, Electronic Throttle Control, Check 4X4



Illuminates when the powertrain or four-wheel drive require service. Have the system checked as soon as possible.

Transmission Temperature



Illuminates when the transmission temperature exceeds the normal operating range.

WHAT ARE THE INSTRUMENT CLUSTER INDICATORS

Indicators notify you of various features that are active on your vehicle.

Instrument Cluster

INSTRUMENT CLUSTER INDICATORS - EXCLUDING: RAPTOR

Depending on your vehicle options and instrument cluster type, not all indicators shown are available.

Adaptive Cruise Control



See **Adaptive Cruise Control** (page 263).

Automatic High Beam



See **Automatic High Beam Control** (page 101).

Auto Hold

Auto Hold Active



See **Auto Hold** (page 227).

Auto Hold Unavailable



See **Auto Hold** (page 227).

Auto-Start-Stop

Auto-Start-Stop Available



See **Auto-Start-Stop** (page 179).

Auto-Start-Stop Unavailable



See **Auto-Start-Stop** (page 179).

Blind Spot Monitor



See **Blind Spot Information System** (page 301).

Cruise Control



See **Cruise Control** (page 261).

Differential Lock



See **Electronic Locking Differential** (page 208).



Drive Modes

See **Drive Mode Control** (page 278).

Note: Available drive modes could vary depending on your vehicle options and model.



Eco mode.



Mud/Ruts mode.



Normal mode.



Rock crawl mode.



Sand mode.



Slippery mode.



Sport mode.

Instrument Cluster



Tow Haul mode.



Trail mode.

Four-Wheel Drive



See **Four-Wheel Drive** (page 199).



Note: Some indicators appear different depending on vehicle options.

Fog Lamps



Front fog lamp. See **Using the Front Fog Lamps** (page 99).

High Beam



See **Headlamps** (page 96).

Lamps On



See **Exterior Lighting Control** (page 96).

Lane Centering



See **Lane Centering** (page 270).

Lane Keeping System



See **Lane Keeping System** (page 290).

Pre-Collision Assist



See **Pre-Collision Assist** (page 310).



Stability Control and Traction Control



See **Traction Control** (page 229). See **Stability Control** (page 231).



Trail Control



See **Trail Control** (page 235).

Trail Turn Assist



See **Trail Turn Assist** (page 238).



Turn Signal Lamps



See **Using the Turn Signal Lamps** (page 98).

INSTRUMENT CLUSTER INDICATORS - RAPTOR

Depending on your vehicle options and instrument cluster type, not all indicators shown are available.

Instrument Cluster

Adaptive Cruise Control



See **Adaptive Cruise Control** (page 263).

Automatic High Beam



See **Automatic High Beam Control** (page 101).

Auto Hold

Auto Hold Active



See **Auto Hold** (page 227).

Auto Hold Unavailable



See **Auto Hold** (page 227).

Auto-Start-Stop

Auto-Start-Stop Available



See **Auto-Start-Stop** (page 179).

Auto-Start-Stop Unavailable



See **Auto-Start-Stop** (page 179).

Blind Spot Monitor



See **Blind Spot Information System** (page 301).

Cruise Control



See **Cruise Control** (page 261).

Differential Lock



See **Electronic Locking Differential** (page 208).



Drive Modes

See **Drive Mode Control** (page 278).

Note: Available drive modes could vary depending on your vehicle options and model.



Baja mode.



Mud/Ruts mode.



Normal mode.



Off road mode.



Rock crawl mode.



Slippery mode.



Sport mode.



Tow Haul Mode.

Instrument Cluster

Four-Wheel Drive



See **Four-Wheel Drive** (page 199).



Note: Some indicators appear different depending on vehicle options.

Fog Lamps



Front fog lamp. See **Using the Front Fog Lamps** (page 99).

High Beam



See **Headlamps** (page 96).

Lamps On



See **Exterior Lighting Control** (page 96).

Lane Centering



See **Lane Centering** (page 270).

Lane Keeping System



See **Lane Keeping System** (page 290).

Pre-Collision Assist



See **Pre-Collision Assist** (page 310).



Stability Control and Traction Control



See **Traction Control** (page 229). See **Stability Control** (page 231).



Trail Control



See **Trail Control** (page 235).

Trail Turn Assist



See **Trail Turn Assist** (page 238).



Turn Signal Lamps



See **Using the Turn Signal Lamps** (page 98).

Instrument Cluster Display

USING THE INSTRUMENT CLUSTER DISPLAY CONTROLS - EXCLUDING: RAPTOR



WARNING: Driving while distracted can result in loss of vehicle control, crash and injury. We strongly recommend that you use extreme caution when using any device that may take your focus off the road. Your primary responsibility is the safe operation of your vehicle. We recommend against the use of any hand-held device while driving and encourage the use of voice-operated systems when possible. Make sure you are aware of all applicable local laws that may affect the use of electronic devices while driving.

The controls are on the steering wheel.

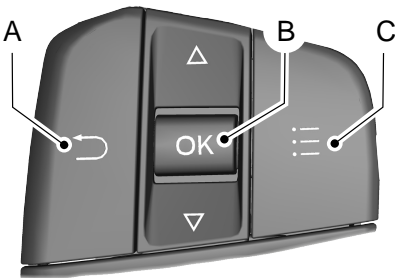

- A Back button.
- B OK button.
- C Menu button.

Back Button

Press to go back or exit a menu.

OK Button

Press to make a selection.

Menu Button

Press to display the submenu.

Scroll Buttons

Press the toggle up or down button to scroll through menu items.

Status Indicator



Menu items with a checkbox indicate a feature's status. A check in the box indicates the feature is on, an unchecked box indicates the feature is off.

USING THE INSTRUMENT CLUSTER DISPLAY CONTROLS - RAPTOR



WARNING: Driving while distracted can result in loss of vehicle control, crash and injury. We strongly recommend that you use extreme caution when using any device that may take your focus off the road. Your primary responsibility is the safe operation of your vehicle. We recommend against the use of any hand-held device while driving and encourage the use of voice-operated systems when possible. Make sure you are aware of all applicable local laws that may affect the use of electronic devices while driving.

The controls are on the steering wheel.

Instrument Cluster Display

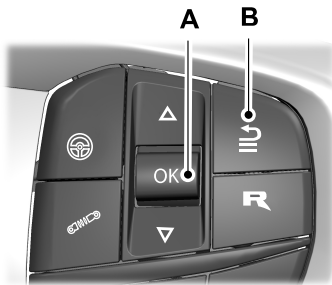

- A OK button.
- B Back and Menu button.

Back Button

Press to go back or exit a menu.

OK Button

Press to make a selection.

Menu Button

Press to display the submenus.

Scroll Buttons

Press the toggle up or down button to scroll through menu items.

Status Indicator



Menu items with a check box indicate a feature's status. A check in the box indicates the feature is on, and unchecked indicates the feature is off.

INSTRUMENT CLUSTER DISPLAY MAIN MENU - VEHICLES WITH: 12 INCH SCREEN, EXCLUDING: RAPTOR

Depending on your vehicle options, some menu items can appear different or not at all.

Note: *For your safety, some features are speed-dependent and could be unavailable when your vehicle is above a certain speed.*

Menu Item	Submenu 1	Submenu 2
MyView	Configure MyView	See Customizing the Instrument Cluster Display (page 132).
Trip/Fuel	Trip 1	
	Trip 2	
	Fuel Economy	
	Auto StartStop	
	Seat belts	
Off-Road	Driver Assistance	
	Off-Road Status	
	Pitch & Roll	

Instrument Cluster Display

Menu Item	Submenu 1	Submenu 2
	Power distribution	
	Driver Assistance	
Towing	Trailer Information	
	Trailer tire info	
	Trailer light status	
	Towing status	
	Driver Assistance	
Navigation	See Navigation (page 521).	
Phone	See Phone (page 514).	
Audio	See Audio System (page 498).	
Settings	Configure Gauges	Show selectable gauges
		Left Selectable Gauge
		Right Selectable Gauge
	Secondary Speedometer	
	Turn-by-turn indication	
	Border Crossing	Reminder On
		Reminder Off
	Neutral Tow	
Vehicle Maintenance	Tire Pressure	
	Tire Monitor	
	Engine Information	
	Oil level	
	Oil Life	
	Engine Air Filter	

Instrument Cluster Display

INSTRUMENT CLUSTER DISPLAY MAIN MENU - RAPTOR, VEHICLES WITH: 12 INCH SCREEN

Depending on your vehicle options, some menu items can appear different or not at all.

Note: *For your safety, some features are speed-dependent and could be unavailable when your vehicle is above a certain speed.*

Menu Item	Submenu 1	Submenu 2	
MyView	Configure MyView	See Customizing the Instrument Cluster Display (page 132).	
Trip/Fuel	Trip 1		
	Trip 2		
	Fuel economy		
	Auto StartStop		
	Seat belts		
	Driver Assistance		
	Off-Road	Off-Road Status	
	Raptor status		
	Pitch & Roll		
	Power distribution		
	MyGauges		
	Measurements		
	Driver Assistance		
	Towing	Trailer Information	
		Trailer tire info	
Trailer light status			
Towing status			
Driver Assistance			
Navigation	See Navigation (page 521).		
Phone	See Phone (page 514).		

Instrument Cluster Display

Menu Item	Submenu 1	Submenu 2
Audio	See Audio System (page 498).	
Settings	Configure Gauges	Show selectable gauges
		Left Selectable Gauge
		Right Selectable Gauge
	Secondary Speedometer	
	Turn-by-turn indication	
	Performance Shift Indicator	Enabled
		Shift Tone
		Shift Point
	Border Crossing	Reminder On
		Reminder Off
	Neutral Tow	
Vehicle Maintenance	Tire Pressure	
	Tire Monitor	
	Engine Information	
	Oil level	
	Oil Life	
	Engine Air Filter	

Instrument Cluster Display

INSTRUMENT CLUSTER DISPLAY MAIN MENU - VEHICLES WITH: 8 INCH SCREEN

Depending on your vehicle options, some menu items can appear different or not at all.

Note: For your safety, some features are speed-dependent and could be unavailable when your vehicle is above a certain speed.

Main Menu	Submenu 1	Submenu 2
MyView	Configure MyView	See Customizing the Instrument Cluster Display (page 132).
Trip/Fuel	Trip 1	
	Trip 2	
	Fuel Economy	
	Eco Coach	
	Auto StartStop	
	Seatbelt Status	
Off-Road	Off-Road Status	
	Power Distribution	
	Vehicle Gauges	
	Engine Info	
Towing	Trailer Information	
	Trailer Light Status	
	Towing Status	
		Configure View
Audio	See Audio System (page 498).	
Phone	See Phone (page 514).	
Navigation	See Navigation (page 521).	
Settings	Screen Content	Secondary Speedometer
		Left Gauge
		Right Gauge

Instrument Cluster Display

Main Menu	Submenu 1	Submenu 2
		Border Crossing Reminder
		Turn-By-Turn Indication
	Classic View	Round Speedometer Gauge
		Digital Speedometer Only
Vehicle Maintenance	Oil Life	
	Engine Air Filter	
	Tire Pressure	

Instrument Cluster Display

CUSTOMIZING THE INSTRUMENT CLUSTER DISPLAY - VEHICLES WITH: 8 INCH SCREEN

Adding Screens Using MyView

1. Using the instrument cluster display controls on the steering wheel, select **MyView**.
2. Select **Configure MyView**.
3. Select an item from the list that you want to include in your MyView list.

Note: A minimum of two items must be selected.

Note: You can select a maximum of seven items to include in MyView.

4. Press the **OK** button.

Configuring Gauges

1. Select **Settings**.
2. Select **Screen Content**.
3. Select **Left Gauge** or **Right Gauge** to switch the gauge on or off.

CUSTOMIZING THE INSTRUMENT CLUSTER DISPLAY - VEHICLES WITH: 12 INCH SCREEN

Adding Screens Using MyView

1. Using the instrument cluster display controls on the steering wheel, select **MyView**.
2. Select **Configure MyView**.
3. Select an item from the list that you want to include in your MyView list.

Note: A minimum of two items must be selected.

Note: You can select a maximum of seven items to include in MyView.

4. Press the **OK** button.

Configuring Gauges

1. Select **Settings**.
2. Select **Configure Gauges**.
3. Select to change the left-hand side and right-hand side gauges.

Personalized Settings

CHANGING THE LANGUAGE

1.  Press the button on the touchscreen.
2. Press **General**.
3. Press **Language**.
4. Select a language.

4. Select a pressure unit.

CHANGING THE MEASUREMENT UNIT

1.  Press the button on the touchscreen.
2. Press **General**.
3. Press **Measurement Units**.
4. Select a measurement unit.

CHANGING THE TEMPERATURE UNIT

1.  Press the button on the touchscreen.
2. Press **General**.
3. Press **Temperature Units**.
4. Select a temperature unit.

CHANGING THE TIRE PRESSURE UNIT

1.  Press the button on the touchscreen.
2. Press **General**.
3. Press **Tire Pressure Units**.

Trip Computer

ACCESSING THE TRIP COMPUTER

1. Use the instrument cluster display controls to navigate to the main menu.
2. Select **Trip/Fuel**.
3. Select **Trip 1** or **Trip 2**.

RESETTING THE TRIP COMPUTER

1. Use the instrument cluster display controls to navigate to the main menu.
2. Select **Trip/Fuel**.
3. Select **Trip 1** or **Trip 2**.
4. Press and hold the **OK** button for a few seconds.

Remote Start

WHAT IS REMOTE START

The system allows you to remotely start your vehicle and to adjust the interior temperature according to the settings that you chose.

REMOTE START PRECAUTIONS



WARNING: Do not start the engine in a closed garage or in other enclosed areas. Exhaust fumes are toxic. Always open the garage door before you start the engine. Failure to follow this instruction could result in personal injury or death.

REMOTE START LIMITATIONS

Remote start does not work under the following conditions:

- The alarm horn is sounding.
- The hood is open.
- The transmission is not in park (P).
- The ignition is on.
- The battery voltage is below the minimum operating voltage.
- Remote start is not enabled.

Note: Do not use remote start if the fuel level is low.

Note: You can use remote start with FordPass. See **Connecting FordPass to the Modem** (page 493).

ENABLING REMOTE START

1.



Press the button on the touchscreen.

2. Press **Vehicle**.
3. Press **Remote Start Setup**.
4. Switch **Remote Start** on or off.

Note: To remote start with FordPass, make sure that the modem is enabled. See **Enabling and Disabling the Modem** (page 493).

REMOTELY STARTING AND STOPPING THE VEHICLE

Remotely Starting the Vehicle



Press the button on the remote control.



Within three seconds, press the button on the remote control.

Within three seconds, press the button again.

Note: You can also use FordPass to start the vehicle.

Note: The vehicle doors lock when you successfully remote start your vehicle.

Note: The turn signal lamps flash twice.

Note: The parking lamps turn on when the vehicle is running.

Note: The horn sounds if the system fails to start.

Note: All other vehicle systems remain off when you have remotely started the vehicle.

Note: The vehicle remains secured when you have remotely started the vehicle. A valid key must be inside your vehicle to switch the ignition on and drive your vehicle.

Remotely Stopping the Vehicle



Press the button on the remote control.

Remote Start

EXTENDING THE REMOTE START DURATION

To extend the remote start duration during remote start, do the following:



Press the button on the remote control.



Within three seconds, press the button on the remote control.

Within three seconds, press the button again.

If the duration is set to 15 minutes, the duration extends by another 15 minutes. This provides a total of 30 minutes.

Note: Remote start can only be extended once.

Note: A maximum of two remote starts, or one remote start with an extension, are allowed. To reset the restart procedure switch the vehicle to on, then to off.

REMOTE START REMOTE CONTROL INDICATORS

Remote Control Feedback

An LED on the remote control provides status feedback of remote start or stop commands.

LED	Status
Solid green.	Remote start successful.
Solid red.	Remote stop successful.
Blinking red.	Request failed or status not received.
Blinking green.	Status incomplete.

REMOTE START SETTINGS

To access the settings menu:

- Press the button on the touchscreen.
 A black square icon containing a white circle with two dots, representing the touchscreen button.
- Press **Vehicle**.
- Press **Remote Start Setup**.

Switching Climate Control Auto Mode On and Off

- Press **Auto** or **Last settings**.

Note: If you switch the auto mode on, the system attempts to heat or cool the interior to 72°F (22°C). When you switch the vehicle on, the climate control system returns to the last used settings.

Note: If you switch the last settings on, the system remembers the last used settings.

Heated Seat Settings

- Press **Seats**.
- Press **Auto** or **Off**.

Note: If you switch the heated seat settings on, the heated seats turn on during cold weather.

Heated Steering Wheel Settings

- Press **Seats and Steering Wheel**.
- Press **Auto** or **Off**.

Note: If you switch the heated steering wheel settings on, the heated steering wheel turns on during cold weather.

Remote Start Duration

- Press **Duration**.
- Press the duration you prefer.

Climate Control - Vehicles With: Automatic Temperature Control

IDENTIFYING THE CLIMATE CONTROL UNIT



Depending on your vehicle options, the controls could look different than what you see here.

SWITCHING CLIMATE CONTROL ON AND OFF



Press the button.

SWITCHING RECIRCULATED AIR ON AND OFF



Press the button to recirculate air currently in the passenger compartment.

Note: Recirculated air may turn off automatically, or prevent you from switching on in all air flow modes except MAX A/C to reduce the risk of fogging. Recirculation may also turn on and off automatically in various air distribution control combinations to improve heating or cooling efficiency.

SWITCHING AIR CONDITIONING ON AND OFF



Press the button.

Note: Under certain conditions, the air conditioning compressor could continue to operate after you switch air conditioning off.

Note: To keep the system and its components fully functional, switch air conditioning on and let your vehicle idle at least once per month for a minimum of two minutes.

SWITCHING MAXIMUM DEFROST ON AND OFF



Press the button.

Air flows through the windshield air vents, the temperature is set to the highest setting, and the blower motor adjusts to the highest speed.

You can also use this setting to defog and clear the windshield of a thin covering of ice.

Note: To prevent window fogging, you cannot select recirculated air when maximum defrost is on.

Note: The heated rear window and heated mirrors also turn on when you select maximum defrost.

Note: When maximum defrost is on, the air conditioning compressor may continue to operate even though you switch off the A/C.

SWITCHING MAXIMUM COOLING ON AND OFF



Press the button.

Note: When you switch maximum cooling off, air conditioning remains on.

Climate Control - Vehicles With: Automatic Temperature Control

SWITCHING THE HEATED REAR WINDOW ON AND OFF



Press the touchscreen to clear the rear window of thin ice and fog. The heated rear window turns off after a short period of time.

Note: Do not use harsh chemicals, razor blades or other sharp objects to clean or remove decals from the inside of the heated rear window as this could cause damage to the heated rear window grid lines not covered by the vehicle Warranty.

SETTING THE BLOWER MOTOR SPEED



Press + or - to select the blower motor speed.

SETTING THE TEMPERATURE

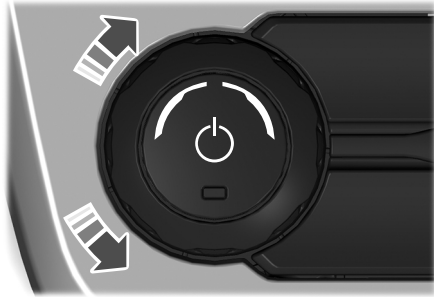

Turn the control on the left-hand side of the climate control to set the left-hand temperature.

Note: This control also sets the right-hand side temperature when you switch off dual zone mode.

Turn the control on the right-hand side of the climate control to set the right-hand temperature.

DIRECTING THE FLOW OF AIR

Directing Air to the Windshield Air Vents



Press the button on the touchscreen to access the climate controls.



Press the button.

Directing Air to the Instrument Panel Air Vents



Press the button on the touchscreen to access the climate controls.



Press the button.

Directing Air to the Footwell Air Vents



Press the button on the touchscreen to access the climate controls.



Press the button.

AUTO MODE

SWITCHING AUTO MODE ON AND OFF



Press the button to switch auto mode on. Repeatedly press the button to adjust auto mode.

Climate Control - Vehicles With: Automatic Temperature Control

Adjust the blower motor control or air distribution control to switch auto mode off.

SWITCHING DUAL MODE ON AND OFF



Press the button on the touchscreen to access the climate controls.



Press the button.

Climate Control - Vehicles With: Manual Temperature Control

IDENTIFYING THE CLIMATE CONTROL UNIT



Depending on your vehicle options, the controls could look different than what you see here.

SWITCHING CLIMATE CONTROL ON AND OFF



Press the button.

SWITCHING RECIRCULATED AIR ON AND OFF



Press the button to recirculate air currently in the passenger compartment.

Note: Recirculated air may turn off automatically, or prevent you from switching on in all air flow modes except MAX A/C to reduce the risk of fogging. Recirculation may also turn on and off automatically in various air distribution control combinations to improve heating or cooling efficiency.

SWITCHING AIR CONDITIONING ON AND OFF



Press the button.

Note: Under certain conditions, the air conditioning compressor could continue to operate after you switch air conditioning off.

Note: To keep the system and its components fully functional, switch air conditioning on and let your vehicle idle at least once per month for a minimum of two minutes.

SWITCHING MAXIMUM DEFROST ON AND OFF



Press the button.

Air flows through the windshield air vents, the temperature is set to the highest setting, and the blower motor adjusts to the highest speed.

You can also use this setting to defog and clear the windshield of a thin covering of ice.

Note: To prevent window fogging, you cannot select recirculated air when maximum defrost is on.

Note: The heated rear window and heated mirrors also turn on when you select maximum defrost.

Note: When maximum defrost is on, the air conditioning compressor may continue to operate even though you switch off the A/C.

SWITCHING MAXIMUM COOLING ON AND OFF



Press the button.

Note: When you switch maximum cooling off, air conditioning remains on.

Climate Control - Vehicles With: Manual Temperature Control

SWITCHING THE HEATED REAR WINDOW ON AND OFF (IF

EQUIPPED)

 Press the touchscreen to clear the rear window of thin ice and fog. The heated rear window turns off after a short period of time.

Note: Do not use harsh chemicals, razor blades or other sharp objects to clean or remove decals from the inside of the heated rear window as this could cause damage to the heated rear window grid lines not covered by the vehicle Warranty.

SETTING THE BLOWER MOTOR SPEED

 Turn the control to adjust the volume of air circulated in the vehicle.

SETTING THE TEMPERATURE

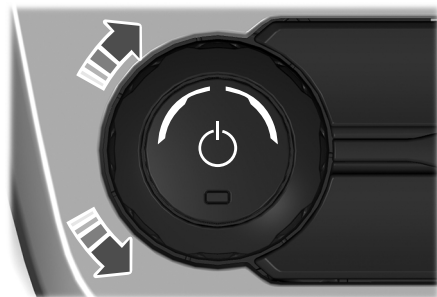

Turn the temperature control counterclockwise for cooler temperature settings.

Turn the temperature control clockwise for warmer temperature settings.

DIRECTING THE FLOW OF AIR

Directing Air to the Windshield Air Vents

 Press the button on the touchscreen to access the climate controls.

 Press the button.

Directing Air to the Instrument Panel Air Vents

 Press the button on the touchscreen to access the climate controls.

 Press the button.

Directing Air to the Footwell Air Vents

 Press the button on the touchscreen to access the climate controls.

 Press the button.

CLIMATE CONTROL HINTS

General Hints

- Prolonged use of recirculated air may cause the windows to fog up.
- You may feel a small amount of air from the footwell air vents regardless of the air distribution setting.
- To reduce humidity build-up inside your vehicle, do not drive with the system switched off or with recirculated air always switched on.

Climate Control - Vehicles With: Manual Temperature Control

- Do not place objects under the front seats as this may interfere with the airflow to the rear seats.
- Remove any snow, ice or leaves from the air intake area at the base of the windshield.
- To improve the time to reach a comfortable temperature in hot weather, drive with the windows open until you feel cold air through the air vents.

Quickly Heating the Interior

1. Adjust the blower motor speed to the highest speed setting.
2. Adjust the temperature control to the highest setting.
3. Direct air to the footwell air vents.

Recommended Settings for Heating

1. Adjust the blower motor speed to the center setting.
2. Adjust the temperature control to the midway point of the hot settings.
3. Direct air to the footwell air vents.

Quickly Cooling the Interior

1. Press **MAX A/C**.
2. Drive with the windows open for a short period of time.

Recommended Settings for Cooling

1. Adjust the blower motor speed to the center setting.
2. Adjust the temperature control to the midway point of the cold settings.
3. Direct air to the instrument panel air vents.

Defogging the Side Windows in Cold Weather

1. Direct air to the instrument panel and windshield air vents.
2. Press and release **A/C**.
3. Adjust the temperature control to the setting you prefer.
4. Adjust the blower motor speed to the highest setting.
5. Direct air toward the side windows.
6. Close the instrument panel air vents.

Interior Air Quality

WHAT IS THE CABIN AIR FILTER

The cabin air filter improves the quality of air in your vehicle by trapping dust, pollen and other particles.

REPLACING THE CABIN AIR FILTER

Replace the filter at regular intervals. See **Scheduled Maintenance** (page 534).

The cabin air filter is behind the glove compartment.

To remove the lower glove compartment and access the filter:

1. Open the glove compartment.

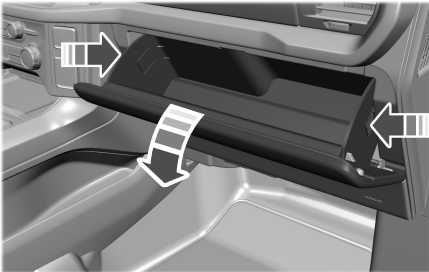

2. Press the tab on each side.
3. Fully lower the glove compartment.
4. Pull the glove compartment toward you.

Front Seats

FRONT SEAT PRECAUTIONS

WARNING: Sitting improperly, out of position or with the seatback reclined too far can take weight off the seat cushion and affect the decision of the passenger sensing system, resulting in serious injury or death in the event of a crash. Always sit upright against your seat back, with your feet on the floor.

WARNING: Do not recline the seat backrest too far as this can cause the occupant to slide under the seatbelt, resulting in personal injury in the event of a crash.

WARNING: Do not place objects higher than the top of the seat backrest. Failure to follow this instruction could result in personal injury or death in the event of a sudden stop or crash.

WARNING: Do not adjust the driver seat or seat backrest when your vehicle is moving. This may result in sudden seat movement, causing the loss of control of your vehicle.

SITTING IN THE CORRECT POSITION

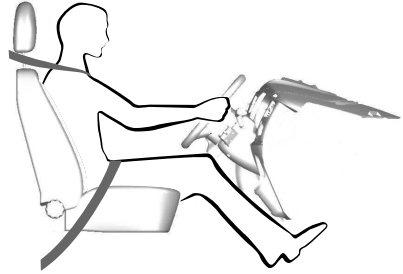

When you use them properly, the seat, head restraint, seatbelt and airbags will provide optimum protection in the event of a crash.

We recommend that you follow these guidelines:

- Sit in an upright position with the base of your spine as far back as possible.
- Do not recline the seat backrest so that your torso is more than 30 degrees from the upright position.
- Adjust the head restraint so that the top of it is level with the top of your head and as far forward as possible. Make sure that you remain comfortable.
- Keep sufficient distance between yourself and the steering wheel. We recommend a minimum of 10 in (25 cm) between your breastbone and the airbag cover.
- Hold the steering wheel with your arms slightly bent.

Front Seats

- Bend your legs slightly so that you can press the pedals fully.
- Position the shoulder strap of the seatbelt over the center of your shoulder and position the lap strap tightly across your hips.

Make sure that your driving position is comfortable and that you can maintain full control of your vehicle.

MANUAL SEATS

HEADRESTRAINT COMPONENTS

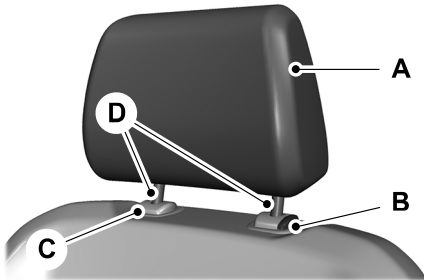

The head restraints consist of:

- A An energy absorbing head restraint.
- B Guide sleeve lock and release button.
- C Guide sleeve.
- D Two steel stems.

ADJUSTING THE HEAD RESTRAINT

WARNING: Fully adjust the head restraint before you sit in or operate your vehicle. This will help minimize the risk of neck injury in the event of a crash. Do not adjust the head restraint when your vehicle is moving.

WARNING: The head restraint is a safety device. Whenever possible it should be installed and properly adjusted when the seat is occupied. Failure to adjust the head restraint properly could reduce its effectiveness during certain impacts.

WARNING: Adjust the head restraints for all passengers before you drive your vehicle. This will help minimize the risk of neck injury in the event of a crash. Do not adjust the head restraints when your vehicle is moving.

Note: Adjust the seat backrest to an upright driving position before adjusting the head restraint. Adjust the head restraint so that the top of it is level with the top of your head. Make sure that you remain comfortable. If you are tall, adjust the head restraint to its highest position.

Pull the head restraint up to raise it.

To lower the head restraint:

1. Press and hold the adjust and release button.
2. Push the head restraint down.

Front Seats

REMOVING THE HEAD RESTRAINT

1. Pull up the head restraint until it reaches its highest position.
2. Press and hold the adjust and release button and the unlock and remove button.
3. Pull up the head restraint.

INSTALLING THE HEAD RESTRAINT

Align the steel stems into the guide sleeves and push the head restraint down until it locks.



MOVING THE SEAT BACKWARD AND FORWARD



WARNING: Do not adjust the driver seat or seat backrest when your vehicle is moving. This may result in sudden seat movement, causing the loss of control of your vehicle.



WARNING: Make sure the seat fully locks into place by rocking it backward and forward. Not securing the seat into the locked position can be dangerous in a crash and could cause serious personal injury or death.



WARNING: Accessory seat covers not released by Ford Motor Company could prevent the seatbelt from retracting correctly. This could cause the seatbelt to become slack which could increase the risk of injuries in a crash.

ADJUSTING THE SEAT BACKREST



WARNING: Reclining the seatback can cause an occupant to slide under the seat's seatbelt, resulting in severe personal injuries in the event of a crash.



WARNING: Do not place cargo or any objects behind the seatback before returning it to the original position.



Front Seats

ADJUSTING THE SEAT HEIGHT (If Equipped)



ADJUSTING THE LUMBAR SUPPORT (If Equipped)

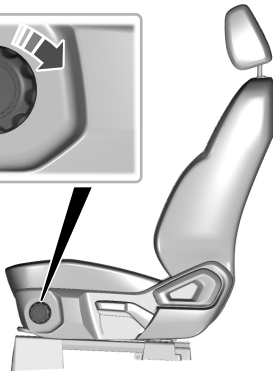
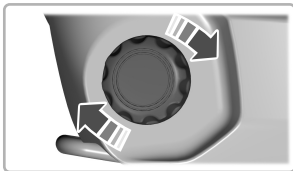

POWER SEATS (IF EQUIPPED)

HEADRESTRAINT COMPONENTS

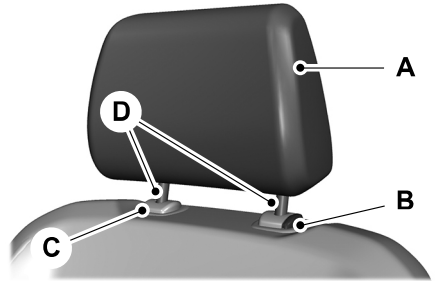

The head restraints consist of:

- A An energy absorbing head restraint.
- B Guide sleeve lock and release button.
- C Guide sleeve.
- D Two steel stems.

ADJUSTING THE HEAD RESTRAINT

⚠ WARNING: Fully adjust the head restraint before you sit in or operate your vehicle. This will help minimize the risk of neck injury in the event of a crash. Do not adjust the head restraint when your vehicle is moving.

⚠ WARNING: The head restraint is a safety device. Whenever possible it should be installed and properly adjusted when the seat is occupied. Failure to adjust the head restraint properly could reduce its effectiveness during certain impacts.

Front Seats



WARNING: Adjust the head restraints for all passengers before you drive your vehicle. This will help minimize the risk of neck injury in the event of a crash. Do not adjust the head restraints when your vehicle is moving.

Pull the head restraint up to raise it.

To lower the head restraint:

1. Press and hold the adjust and release button.
2. Push the head restraint down.

REMOVING THE HEAD RESTRAINT

1. Pull up the head restraint until it reaches its highest position.
2. Press and hold the adjust and unlock button.
3. Pull up the head restraint.

INSTALLING THE HEAD RESTRAINT

Align the steel stems into the guide sleeves and push the head restraint down until it locks.

MOVING THE SEAT BACKWARD AND FORWARD



WARNING: Do not adjust the driver seat or seat backrest when your vehicle is moving. This may result in sudden seat movement, causing the loss of control of your vehicle.



WARNING: Accessory seat covers not released by Ford Motor Company could prevent the seatbelt from retracting correctly. This could cause the seatbelt to become slack which could increase the risk of injuries in a crash.

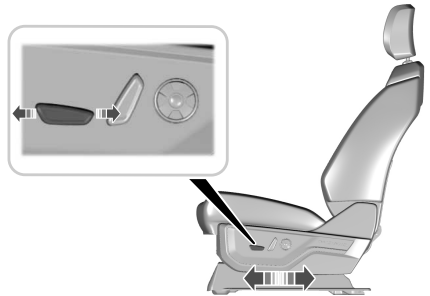

ADJUSTING THE SEAT CUSHION

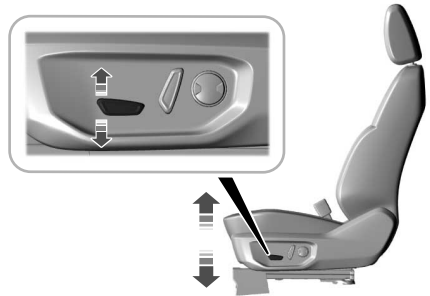

ADJUSTING THE SEAT BACKREST



WARNING: Reclining the seatback can cause an occupant to slide under the seat's seatbelt, resulting in severe personal injuries in the event of a crash.

Front Seats



WARNING: Do not place cargo or any objects behind the seatback before returning it to the original position.

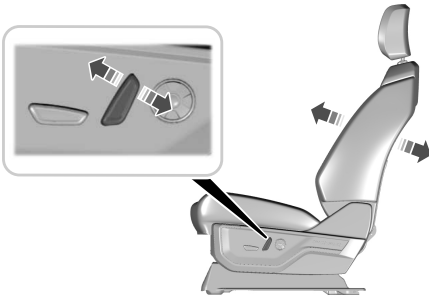

ADJUSTING THE SEAT HEIGHT

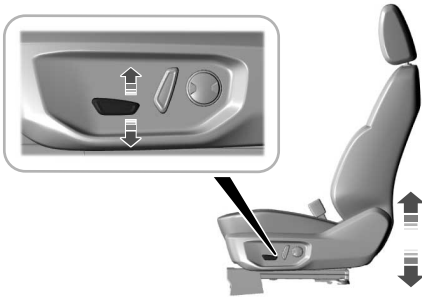

ADJUSTING THE LUMBAR SUPPORT



HEATED SEATS (IF EQUIPPED)

HEATED SEAT PRECAUTIONS



WARNING: Use caution when using the heated seat if you are unable to feel pain to your skin because of advanced age, chronic illness, diabetes, spinal cord injury, medication, alcohol use, exhaustion or other physical conditions. The heated seat could cause burns even at low temperatures, especially if used for long periods of time. Failure to follow this instruction could result in personal injury.



WARNING: Do not poke sharp objects into the seat cushion or seat backrest. This could damage the heated seat element and cause it to overheat. Failure to follow this instruction could result in personal injury.

Front Seats



WARNING: Do not place anything on the seat that blocks the heat, for example a seat cover or a cushion. This could cause the seat to overheat. Failure to follow this instruction could result in personal injury.

Do not:

- Place heavy objects on the seat.
- Operate the heated seat if water or any other liquid spills on the seat. Allow the seat to dry.

SWITCHING THE HEATED SEATS ON AND OFF

The vehicle must be running to use this feature.



Press the heated seat symbol to cycle through the various heat settings and off. The more indicators that display, the warmer the temperature of the seat.

Note: *The heated seats may remain on after you remote start your vehicle, based on your remote start settings. The heated seats may also turn on when you start your vehicle if they were on when you switched your vehicle off.*

Rear Seats

MANUAL SEATS

HEADRESTRAINT COMPONENTS

Rear Seat Outermost Head Restraints

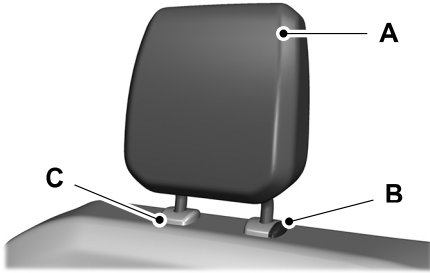

The head restraints consist of:

- A An energy absorbing head restraint.
- B Guide sleeve.
- C Locking guide sleeve.

Rear Seat Center Head Restraint

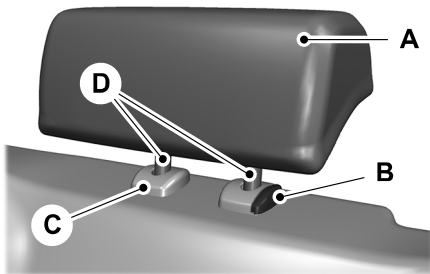

The head restraint consists of:

- A An energy absorbing head restraint.
- B Two steel stems.

- C Guide sleeve adjust and release button.
- D Guide sleeve unlock and remove button (If equipped).

ADJUSTING THE HEAD RESTRAINT

⚠ WARNING: The head restraint is a safety device. Whenever possible it should be installed and properly adjusted when the seat is occupied. Failure to adjust the head restraint properly could reduce its effectiveness during certain impacts.

⚠ WARNING: Adjust the head restraints for all passengers before you drive your vehicle. This will help minimize the risk of neck injury in the event of a crash. Do not adjust the head restraints when your vehicle is moving.

Adjust the head restraint so that the top of it is level with the top of your head.

The outermost head restraints are non-adjustable.

Pull the center head restraint up to raise it.

To lower the center head restraint:

1. Press and hold the unlock and remove button.
2. Push the head restraint down.

REMOVING THE HEAD RESTRAINT

1. Fold the seat backrest forward before removing the head restraint.
2. Pull up the head restraint until it reaches its highest position.

Rear Seats

3. Press and hold the adjust and release button and the unlock and remove button.
4. Pull up the head restraint.

INSTALLING THE HEAD RESTRAINT

1. Fold the seat backrest forward before installing the head restraint.
2. Align the steel stems into the guide sleeves and push the head restraint down until it locks.

FOLDING THE SEAT BACKREST

WARNING: When folding the seat backrest down, take care not to get your fingers caught in the mechanism.



Pull the strap to fold the backrest forward.

Note: Move the front seats forward to avoid interference between the front and rear seats. This provides more access to the back.

UNFOLDING THE SEAT BACKREST

WARNING: When unfolding the seat, make sure that the seatbelts are not trapped behind the seat.

WARNING: Do not place cargo or any objects behind the seatback before returning it to the original position.

WARNING: Make sure that the seats and the seat backrests are secure and fully locked in their catches.

Pull the seat backrest up until it latches in the upright position.

Note: We recommend that you push the seat backrest upright from the passenger side of the vehicle.

FOLDING THE SEATS



Pull one of the straps to fold the seat up.

Rear Seats

UNFOLDING THE SEATS



WARNING: Make sure that cargo and other objects are not trapped under the seat cushion and that you return the seat cushion to the full-down position. Failure to do so may prevent the seat from operating properly, which could increase the risk of serious injury in a crash.

Pull the strap to lower the seat.

Rear Occupant Alert System

WHAT IS THE REAR OCCUPANT ALERT SYSTEM

The rear occupant alert system monitors vehicle conditions and notifies you to check for rear seat occupants when you switch the ignition off.

HOW DOES THE REAR OCCUPANT ALERT SYSTEM WORK

The system monitors when rear doors have been opened and closed to indicate the potential presence of an occupant in the rear seat.

A message displays in the information and entertainment display screen and an audible warning sounds when you switch the ignition off after any of the following conditions have been met:

- A rear door is opened or closed while the ignition is on.
- You switch the ignition on within 15 minutes of a rear door opening and closing.
- You switch the ignition on within 15 minutes of the alert having displayed or sounded.

REAR OCCUPANT ALERT SYSTEM PRECAUTIONS



WARNING: On hot days, the temperature inside the vehicle can rise very quickly. Exposure of people or animals to these high temperatures for even a short time can cause death or serious heat related injuries, including brain damage. Small children are particularly at risk.



WARNING: Do not leave children or pets unattended in your vehicle. Failure to follow this instruction could result in personal injury or death.

REAR OCCUPANT ALERT SYSTEM LIMITATIONS

The system does not detect the presence of objects or passengers in the rear seat. It monitors when rear doors are opened and closed.

Note: *It is possible to receive an alert when there is no rear seat occupant, but alert conditions are met.*

Note: *It is possible to receive no alert when there is an occupant in the rear seat, if alert conditions are not met. For example, if a rear seat occupant does not enter the vehicle through a rear door.*

Note: *The audible warning does not sound when the front door is opened before you switch the ignition off.*

SWITCHING REAR OCCUPANT ALERT SYSTEM ON AND OFF

1. Open the rear occupant alert settings. See **Center Display Overview** (page 507).
2. Switch **Rear Occupant Alert** on or off.

Note: *The default setting is on.*

Note: *Performing a factory reset causes the system to switch on again.*

Semiannual Reminder (If Equipped)

When you switch the system off, a message appears every six months as a reminder that the system is off. You can switch the system back on or leave it off.

Rear Occupant Alert System

REAR OCCUPANT ALERT SYSTEM INDICATORS



Message
Check rear seats for occupants.

Displays when you switch your vehicle off after the alert conditions are met.

The message displays for a short period of time. Press **Close** to acknowledge and remove the message.

Note: Depending on your SYNC version, the graphic may look different from what you see here.

REAR OCCUPANT ALERT SYSTEM AUDIBLE WARNINGS

Sounds when you switch your vehicle off after the alert conditions are met.

The warning sounds for a short period of time.

Memory Function (If Equipped)

WHAT IS THE MEMORY FUNCTION

The memory function recalls the driver seat position.

MEMORY FUNCTION PRECAUTIONS

 **WARNING:** Before activating the memory seat, make sure that the area immediately surrounding the seat is clear of obstructions and that all occupants are clear of moving parts.

 **WARNING:** Do not use the memory function when your vehicle is moving.

LOCATING THE MEMORY FUNCTION BUTTONS



The memory function buttons are on the driver door.

SAVING A PRESET POSITION

1. Switch the ignition on.
2. Adjust the memory features to your preferred position.
3. Press and hold the preferred preset button until you hear a single tone.

You can save up to three preset memory positions at any time.

RECALLING A PRESET POSITION

Press and release a preset button.

Note: You can recall a preset memory position when the ignition is off, or when you place the transmission in park (P) or neutral (N) if the ignition is on and the vehicle is not moving.

Note: Pressing any of the preset buttons or any memory feature control during a memory recall cancels the operation.

Garage Door Opener (If Equipped)

GARAGE DOOR OPENER INTRODUCTION

HomeLink Wireless Control System

The universal garage door opener replaces the common handheld garage door opener with a three-button transmitter integrated into the driver-side sun visor.



How Does The Garage Door Opener Work

The system includes two primary features, a garage door opener and a platform for remote activation of devices within the home. You can program garage doors as well as entry gate operators, security systems, entry door locks and home or office lighting.

Additional assistance can be found online at www.homelink.com/Ford or by calling the toll-free help line at 1-800-355-3515.

Garage Door Opener Limitations

Canadian radio-frequency laws require transmitter signals to time out, or quit, after several seconds – which may not be long enough for HomeLink to pick up the signal. U.S. gate operators time-out in the same manner.

GARAGE DOOR OPENER PRECAUTIONS AND FREQUENCIES

Garage Door Opener Precautions

WARNING: Do not use the system with any garage door opener that does not have the safety stop and reverse feature as required by U.S. Federal Safety Standards (this includes any garage door opener manufactured before April 1, 1982). A garage door opener which cannot detect an object, signaling the door to stop and reverse, does not meet current federal safety standards. Using a garage door opener without these features increases the risk of serious injury or death.

FCC and RSS-210 Industry Canada Compliance

WARNING: Changes or modifications not expressly approved by the party responsible for compliance could void the user's authority to operate the equipment. The term "IC:" before the radio certification number only signifies that Industry Canada technical specifications were met.

This device complies with Part 15 of the FCC Rules and with RSS-210 of Industry Canada. Operation is subject to the following two conditions: (1) this device may not cause harmful interference, and (2) this device must accept any interference received, including interference that may cause undesired operation.

Garage Door Opener (If Equipped)

This equipment complies with FCC radiation exposure limits set forth for an uncontrolled environment. End Users must follow the specific operating instructions for satisfying RF exposure compliance. This transmitter must be at least 8 in (20 cm) from the user and must not be co-located or operating in conjunction with any other antenna or transmitter.

PROGRAMMING THE GARAGE DOOR OPENER

To clear all stored codes in the garage door opener in your vehicle, use the **clear** function. To override one button, use the **reprogram** function.

Note: Make sure that the garage door and security device are free from obstruction when you are programming. Do not program the system with the vehicle in the garage.

Clearing the Garage Door Opener

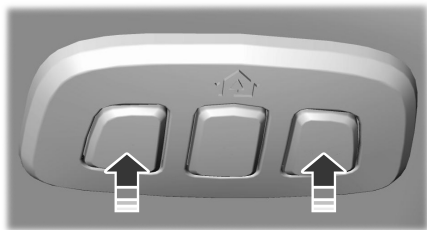

To clear all stored codes in the garage door opener in the vehicle:

1. Press and hold the outer two function buttons simultaneously for approximately 10 seconds until the indicator above the buttons flashes rapidly.
2. When the indicator flashes, release the buttons.

Note: This clears all stored codes. You cannot erase individual buttons.

Note: You can program a maximum of three devices. To change or replace any of the three devices after they have been initially programmed, you must either clear all codes, or reprogram each individual button.

Note: We recommend that upon the sale or lease termination of your vehicle, you erase the programmed function buttons for security reasons.

Reprogramming the Garage Door Opener

If a button on your garage door opener has already been programmed, you can override it. To program a device to a previously trained button:

1. Press and hold the desired button for approximately 20 seconds until the indicator begins to flash.
2. Without releasing the button, proceed to Step 3 of **Programming the Garage Door Opener to your Handheld Transmitter**.

Programming the Garage Door Opener to your Handheld Transmitter

Note: The programming steps below assume you are programming a HomeLink that was not previously programmed. If your HomeLink was previously programmed, you may need to **clear** or **reprogram** your HomeLink buttons.

Note: Put a new battery in the handheld transmitter. This allows for quicker training and accurate transmission of the radio-frequency signal.

Note: Make sure that the garage door and security device are free from obstruction when you are programming. Do not program the system with the vehicle in the garage.

Garage Door Opener (If Equipped)

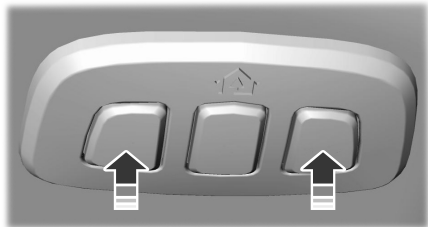

To program your in-vehicle HomeLink function button with your handheld transmitter:

1. With your vehicle parked outside of the garage, switch your vehicle on, but do not start your vehicle.
2. Press and release one of the three HomeLink function buttons that you would like to program.

Note: The indicator should begin to flash. If the indicator does not flash, press and hold the function button for 20 seconds until the indicator begins to flash.

3. Hold your handheld garage door transmitter 1–3 in (2–8 cm) away from the HomeLink button you want to program.
4. Press and hold the handheld transmitter button you want to program while watching the indicator on HomeLink. Continue to hold the handheld button until the HomeLink indicator flashes rapidly or is continuously on.

Note: You may need to use a different method if you live in Canada or have difficulties programming your gate operator or garage door opener.

5. Press and hold the HomeLink button you programmed for two seconds, then release. You may need to do this twice to activate the door.

Note: If the indicator stays on, the programming is complete.

Note: If the HomeLink indicator flashes rapidly, repeat Step 5.

Note: If your device still does not operate, you must program your garage door.

6. To program additional buttons, repeat Steps 1–4.

Note: Make sure you keep the original remote control transmitter for use in other vehicles as well as for future system programming.

Programming the Garage Door Opener to your Garage Door Opener Motor

Note: Make sure that the garage door and security device are free from obstruction when you are programming. Do not program the system with the vehicle in the garage.



1. Press the learn button on the garage door opener motor and then you have 30 seconds to complete the next two steps.
2. Return to your vehicle.

Garage Door Opener (If Equipped)

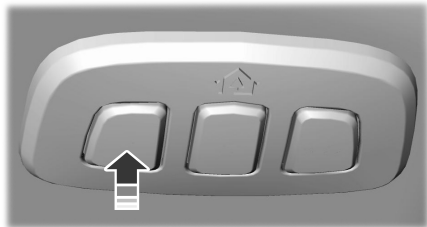

3. Press and hold one of the three HomeLink function buttons you want to program for two seconds, then release.
4. Repeat Step 3. Depending on your brand of garage door opener, you may need to repeat this sequence a third time.

Additional assistance can be found online at www.homelink.com/Ford or by calling the toll-free help line at 1-800-355-3515.

Programming the Garage Door Opener to your Gate Opener Motor

Gate Operator / Canadian Programming

Canadian radio-frequency laws require transmitter signals to time-out (or quit) after several seconds of transmission – which may not be long enough for HomeLink to pick up the signal during programming. Similar to this Canadian law, some U.S. gate operators are designed to time-out in the same manner.

Note: *If programming a garage door opener or gate operator, it is advised that you unplug the device during the **cycling** process to prevent possible overheating.*

1. Press and release your handheld transmitter, **every two seconds**, until the HomeLink indicator flashes rapidly or is continuously on.

2. Release the handheld transmitter button.
3. Press and hold the HomeLink function button you want to program for two seconds, then release. You may need to do this twice to activate the door.

Note: *If the indicator stays on, the programming is complete.*

Note: *If the HomeLink indicator flashes rapidly, repeat Step 3.*

4. To program additional buttons, repeat Steps 1–4.

Additional assistance can be found online at www.homelink.com/Ford or by calling the toll-free help line at 1-800-355-3515.

GARAGE DOOR OPENER ADDITIONAL ASSISTANCE

Video Setup Instructions

[Universal Garage Door Opener: HomeLink](#)

[Universal Garage Door Opener: HomeLink for Genie Intellicode 2](#)

[Universal Garage Door Opener HomeLink for Genie Intellicode](#)

Additional assistance can be found online at www.homelink.com/Ford or by calling the toll-free help line at 1-800-355-3515.

USB Ports

LOCATING THE USB PORTS

USB A

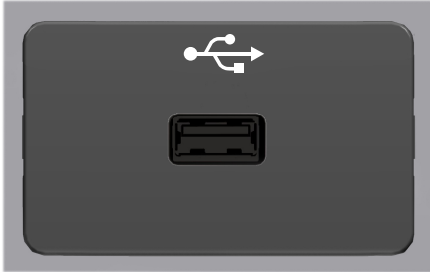

USB C



Data Transfer USB Ports



The USB ports are in the following locations:

- On the lower instrument panel.
- Inside the media bin.
- Inside the center console.

Note: *These USB ports can also charge devices.*

Note: *Not all USB ports in your vehicle have data transfer capabilities.*

Note: *We recommend using only USB-IF certified cables and adapters. Non-certified cables and adapters may not work.*

Charge Only USB Ports



The USB ports are in the following locations:

- Inside the media bin below the instrument panel.
- Inside the center console.
- On the rear of the center console.
- In the cargo area.

PLAYING MEDIA USING THE USB PORT





 **WARNING:** Driving while distracted can result in loss of vehicle control, crash and injury. We strongly recommend that you use extreme caution when using any device that may take your focus off the road. Your primary responsibility is the safe operation of your vehicle. We recommend against the use of any hand-held device while driving and encourage the use of voice-operated systems when possible. Make sure you are aware of all applicable local laws that may affect the use of electronic devices while driving.

1. Connect your device to the USB port.
- 2.



Press the button on the touchscreen to open the application drawer.

USB Ports

3.  Press the USB option.
-  Press the button to play a track.
Press the button again to pause the track.
-  Press the button to skip to the next track.
Press and hold the button to fast forward through the track.
-  Press the button once to return to the beginning of a track.
Repeatedly press the button to return to previous tracks.
Press and hold the button to fast rewind.

CHARGING A DEVICE

Connect your device to the USB port.

Data Transfer USB Ports



You can charge your device through the data transfer USB port when SYNC is on.

Charge Only USB Ports



You can charge your device through the charge only USB port when the vehicle is in accessory mode or when the vehicle is running.

Power Outlet - Vehicles With: 120V Power Outlet

WHAT IS THE POWER OUTLET

The power outlet is a socket that connects an electrical device to your vehicle's power supply.

POWER OUTLET PRECAUTIONS



WARNING: Do not keep electrical devices plugged into the power outlet whenever the device is not in use. The outlet provides power when the vehicle is on. Failure to follow this instruction could result in personal injury.



WARNING: Do not use an extension cord or connect multiple devices to the power outlet. Doing so could result in overloading the power outlet. Failure to follow this instruction could result in fire, personal injury or property damage.

POWER OUTLET LIMITATIONS

You should not use the power outlet for these types of electric devices:

- Cathode ray tube type televisions.
- Motor loads, such as vacuum cleaners, electric saws or other electric power tools and compressor-driven refrigerators.
- Measuring devices which process precise data, such as medical equipment or measuring equipment.
- Other appliances requiring an extremely stable power supply, such as microcomputer-controlled electric blankets or touch sensor lamps.

Note: Some devices may exceed the power rating on the device label when they are initially plugged-in and may require you to press the device power button more than one time in order to allow a soft start. After multiple attempts, if the device remains off, please consider that your device may require more than the available power.

Note: The power outlet provides full available power when the vehicle is in park (P). Power availability may be reduced when the vehicle is in drive (D). If more than one outlet is available in the vehicle, power is divided between the outlets that are in use at the same time.

LOCATING THE POWER OUTLETS

The power outlet could be on the instrument panel, the rear of the center console or in the pickup bed.

POWER OUTLET INDICATORS

The power outlet indicator illuminates to let you know the status of the system.

Indicator Status	Description
On	When the indicator light is on, the outlet is providing power.
Off	When the indicator light is off, there is no power to the outlet.
Flashing	When the indicator light is flashing, the outlet is in a fault mode.

Power Outlet - Vehicles With: 120V Power Outlet

Fault mode

The power outlet temporarily turns off power if the device exceeds the watt limit.

1. Unplug your device.
2. Switch your vehicle off to let the system cool and reset the fault mode.
3. Switch your vehicle back on, but do not plug your device back in.
4. With your vehicle on, make sure the indicator light remains on.
5. Make sure your device does not exceed the power limits and then plug in your device.

Note: *If a fault occurs again, your device may exceed the capacity available from the power outlet.*

Power Outlet - Vehicles With: 12V Power Outlet

WHAT IS THE POWER OUTLET

The power outlet can power devices using a 12 V outlet adapter.

POWER OUTLET PRECAUTIONS

When you switch the vehicle on, you can use the socket to power 12 V appliances with a maximum current rating of 20 A. Do not use the power point over the vehicle capacity of 12 V DC 240 W or a fuse could blow. Do not plug in any device that supplies power to the vehicle through the power points. This could result in damage to vehicle systems. Do not hang any accessory from the accessory plug. Always keep the power point caps closed when not in use. Do not insert objects other than an accessory plug into the power point.

To prevent the battery from running out of charge:

- Do not use the power point longer than necessary when the vehicle is off.
- Do not leave devices plugged in overnight or when you park your vehicle for extended periods.

LOCATING THE POWER OUTLETS

The power outlet could be on the instrument panel, the rear of the center console or in the pickup bed.

Wireless Accessory Charger (If Equipped)

WHAT IS THE WIRELESS ACCESSORY CHARGER

The wireless accessory charger allows you to charge one compatible Qi wireless charging device on the charging area.

WIRELESS ACCESSORY CHARGER PRECAUTIONS



WARNING: Wireless charging devices can affect the operation of implanted medical devices, including cardiac pacemakers. If you have any implanted medical devices, we recommend that you consult with your physician.



WARNING: Remove all metal objects like coins and keys from the charging surface and remove any metal objects attached to your mobile phone before placing the device on the charging surface. Some mobile devices or cases may attract metal objects. Metal objects on the charging surface or attached to the phone may become hot while charging is active. If an object is left on or near the charging surface or attached to the phone while the device is charging, let the objects cool before removing to prevent personal injury.

Keep the charging area clean and remove foreign objects prior to charging a device.

Do not place items with a magnetic strip or radio-frequency identification chip, for example passports, parking tickets, transportation passes or credit cards, near the charging area when charging a device. Damage could occur to the magnetic strip or radio-frequency identification chip.

Do not place metal objects, for example remote controls, coins and candy wrappers, on or near the charging area when charging a device. Metal objects may heat up and degrade the charging performance, in addition to causing interruptions in charging.

Charging could be interrupted, degraded, or could stop if any of the following occur:

- The system detects a foreign object.
- The device is misaligned on the charging area.
- The device moves on the active charging area when the vehicle is in motion.
- The vehicle ambient temperature is too high.
- You attempt to charge a non-Qi compatible device on the wireless charger.

Note: During charging, the device and the charger could heat up, this is normal. If the battery gets hotter than usual, the device may stop charging.

LOCATING THE WIRELESS ACCESSORY CHARGER



The charging area is in the front console below the instrument panel.

CHARGING A WIRELESS DEVICE

Place the device on the center of the charging surface with the charging side down. The charging stops after your device reaches a full charge.

You can use the charger when the vehicle is in accessory mode, when the vehicle is running or when the touchscreen is on.

Wireless Accessory Charger (If Equipped)



Displays on the status bar when wireless charging is in progress.

Note: The charging performance may be affected if your device is in a case. It may be necessary to remove the case to wirelessly charge your device.

Note: Software and firmware updates may affect device compatibility, including the use of unofficial software or firmware. You should verify charging functionality with your specific devices in-vehicle.

WIRELESS ACCESSORY CHARGER – TROUBLESHOOTING

WIRELESS ACCESSORY CHARGER – INFORMATION MESSAGES

Message	Behavior	Description
Phone misaligned or object between phone and charger detected. Correct the condition to resume charging.	Pop-up window.	The system stops charging your device if the system detects the phone is misaligned, or a foreign metal object is on the charging surface.

Storage

CUP HOLDERS (IF EQUIPPED)

LOCATING THE CUP HOLDERS



WARNING: Use caution when stowing items or hot drinks in the cup holders. Items could become loose or spill during hard braking, acceleration or crashes. Failure to follow this instruction could result in personal injury.

Rear Seat Armrest

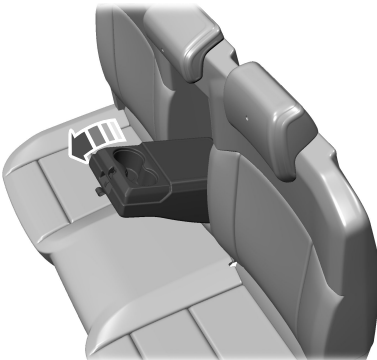

Fold the armrest down to use the armrest and cup holder.

GLOVE COMPARTMENT

OPENING THE GLOVE COMPARTMENT



Pull the latch to open the glove compartment.

LOCKING THE GLOVE COMPARTMENT

You can lock the glove compartment using the key.

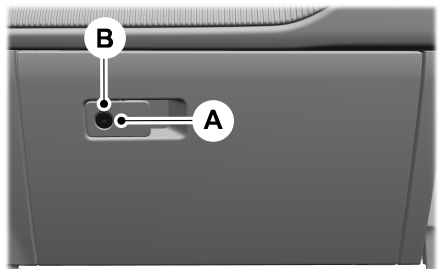

- A Unlock.
- B Lock.

Storage

CENTER CONSOLE

OPENING THE CENTER CONSOLE

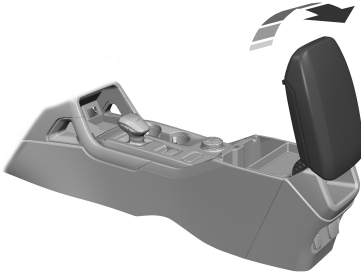

Pull the latch to open the center console.

UNDER SEAT STORAGE (IF EQUIPPED)

LOCATING THE UNDER SEAT STORAGE COMPARTMENT

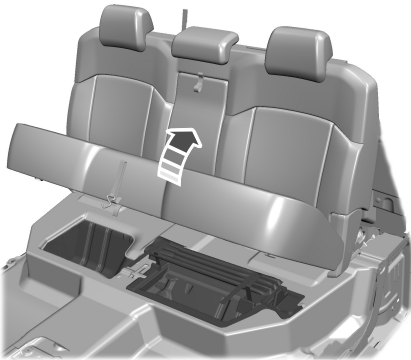

Lift the seat to access the storage. See **Folding the Seats** (page 152).

GLASSES HOLDER

LOCATING THE GLASSES HOLDER

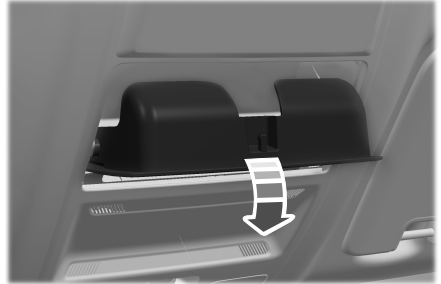

The glasses holder is in the overhead console. Press near the rear edge of the door to open.

Starting and Stopping the Engine

STARTING AND STOPPING THE ENGINE – PRECAUTIONS

WARNING: Extended idling at high engine speeds can produce very high temperatures in the engine and exhaust system, creating the risk of fire or other damage.

WARNING: Do not park, idle or drive your vehicle on dry grass or other dry ground cover. The emission system heats up the engine compartment and exhaust system, creating the risk of fire.

WARNING: Do not start the engine in a closed garage or in other enclosed areas. Exhaust fumes are toxic. Always open the garage door before you start the engine. Failure to follow this instruction could result in personal injury or death.

WARNING: Do not use starting fluid, for example ether, in the air intake system. Such fluid could cause immediate explosive damage to the engine and possible personal injury.

WARNING: Exhaust leaks may result in entry of harmful and potentially lethal fumes into the passenger compartment. If you smell exhaust fumes inside your vehicle, have your vehicle inspected immediately. Do not drive if you smell exhaust fumes.

The powertrain control system meets all Canadian interference-causing equipment standard requirements regulating the impulse electrical field or radio noise.

Note: If you use your vehicle regularly above the altitude of 5,000 ft (1,524 m) and under the temperature of -4.0°F (-20°C), it is recommended to use the alternative engine oil. See **Capacities and Specifications** (page 471).

If you stop your vehicle and leave the engine idling for long periods, we recommend that you do one of the following:

- Open the windows at least 1 in (2.5 cm).
- Set your climate control to outside air.

IGNITION SWITCH (IF EQUIPPED)

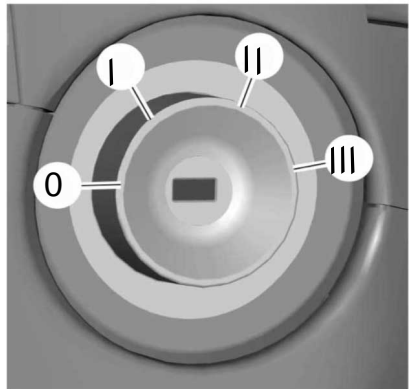

Switching the Ignition Off

Turn the key to position **0**.

Switching the Ignition to Accessory Mode

Turn the key to position **I**. Electrical accessories, for example the radio, operate without the engine running.

Starting and Stopping the Engine

Switching the Ignition On

Turn the key to position **II**. All electrical circuits and accessories are operational and the warning lamps and indicators illuminate.

PUSH BUTTON IGNITION SWITCH (IF EQUIPPED)



Switching the Ignition Off

When the ignition is on or in accessory mode, press the push button ignition switch once without your foot on the brake pedal.

Switching the Ignition to Accessory Mode

When the ignition is off, press the push button ignition switch once without your foot on the brake pedal.

All electrical circuits and accessories are operational and the warning lamps and indicators illuminate.

Note: Your vehicle has a battery saver feature that shuts your vehicle off when it detects a certain amount of battery drain, or after approximately 30 minutes of inactivity in accessory mode.

Note: The system may not function if the remote control is close to metal objects or electronic devices, for example keys or a cell phone.

Note: You need a valid key inside your vehicle to switch the ignition on and start the engine.

STARTING THE ENGINE

STARTING A GASOLINE ENGINE - VEHICLES WITH: PUSH BUTTON START

Before starting your vehicle, check the following:

- Make sure that the headlamps and electrical accessories are off.
- Make sure that the parking brake is on.
- Make sure that the transmission is in park (P).

1. Fully press the brake pedal.

Note: Do not touch the accelerator pedal.



2. Press the push button ignition switch.

Note: The engine may continue cranking for up to 15 seconds or until it starts.

Note: The engine takes longer to start at lower temperatures. It may crank for several seconds when very cold.

STARTING A GASOLINE ENGINE - VEHICLES WITHOUT: PUSH BUTTON START

Before starting your vehicle, check the following:

- Make sure that the headlamps and electrical accessories are off.
- Make sure that the parking brake is on.
- Make sure that the transmission is in park (P).

1. Fully press the brake pedal.

Note: Do not touch the accelerator pedal.

Starting and Stopping the Engine



2. Turn the key to position **III**.

Note: *The engine may continue cranking for up to 15 seconds or until it starts.*

Note: *The engine takes longer to start at lower temperatures. It may crank for several seconds when very cold.*

RESTARTING THE ENGINE AFTER STOPPING IT - VEHICLES WITH: PUSH BUTTON START

The system allows you to start the engine within 10 seconds of switching it off, even if it does not detect a valid passive key.

Within 10 seconds of switching the engine off, fully press the brake pedal and press the push button ignition switch. After 10 seconds, you can no longer start the engine if the system does not detect a valid passive key.

When you start the engine, it remains running until you press the push button ignition switch, even if your vehicle does not detect a valid passive key. If you open and close a door when the engine is running, the system searches for a valid passive key.

ENGINE BLOCK HEATER (IF EQUIPPED)

ENGINE BLOCK HEATER PRECAUTIONS

 **WARNING:** Failure to follow engine block heater instructions could result in property damage or serious personal injury.

 **WARNING:** Do not use your heater with ungrounded electrical systems or two-pronged adapters. There is a risk of electrical shock.

 **WARNING:** Do not fully close the hood, or allow it to drop under its own weight when using the engine block heater. This could damage the power cable and may cause an electrical short resulting in fire, injury and property damage.

We recommend that you do the following for a safe and correct operation:

- Use a 16-gauge outdoor extension cord that is product certified by Underwriter's Laboratory (UL) or Canadian Standards Association (CSA). This extension cord must be suitable for use outdoors, in cold temperatures, and be clearly marked Suitable for Use with Outdoor Appliances. Do not use an indoor extension cord outdoors. This could result in an electric shock or become a fire hazard.
- Use as short an extension cord as possible.
- Do not use multiple extension cords.

Starting and Stopping the Engine

- Make sure that when in operation, the extension cord plug and engine block heater cord plug connections are free and clear of water. This could cause an electric shock or fire.
- If the engine block heater cord is under the hood, do not remove the wiring from its original location. Do not close the hood on the extension wiring.
- Park your vehicle in a clean area, clear of combustible materials.
- Firmly connect the engine block heater cord and the extension cord.
- Check the extension cord for heat anywhere when the system has been operating for approximately 30 minutes.
- Unplug and properly stow the system before starting and driving your vehicle. The protective cover seals the terminals of the engine block heater cord plug when not in use.
- Check the engine block heater system for proper operation before winter.

HOW DOES THE ENGINE BLOCK HEATER WORK

The engine block heater warms the engine coolant. This allows the climate control system to quickly respond. The equipment includes a heater element installed in the engine block and a wire harness. You can connect the system to a grounded 110 volt AC electrical source.

Note: *The engine block heater is most effective when outdoor temperatures are below 0°F (-18°C). We recommend the use of engine block heater to improve engine cold start performance.*

USING THE ENGINE BLOCK HEATER

Make sure the receptacle terminals are clean and dry prior to use. Clean them with a dry cloth if necessary.

The heater uses 0.4 to 1.0 kilowatt-hours of energy per hour of use. The system does not have a thermostat. It achieves maximum temperature after approximately three hours of operation. Using the engine block heater longer than three hours does not improve system performance and unnecessarily uses electricity.

STOPPING THE ENGINE

STOPPING THE ENGINE WHEN YOUR VEHICLE IS STATIONARY - VEHICLES WITHOUT: PUSH BUTTON START

1. Shift into park (P).
2. Apply the parking brake.
3. Wait until the engine reaches idle speed.

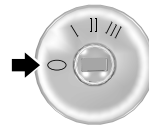

4. Turn the key to position **0**.

STOPPING THE ENGINE WHEN YOUR VEHICLE IS STATIONARY - VEHICLES WITH: PUSH BUTTON START

1. Shift into park (P).
2. Apply the parking brake.
3. Wait until the engine reaches idle speed.

Starting and Stopping the Engine



4. Press the push button ignition switch.

STOPPING THE ENGINE WHEN YOUR VEHICLE IS MOVING - VEHICLES WITHOUT: PUSH BUTTON START

WARNING: Switching off the engine when your vehicle is still moving results in a significant decrease in braking assistance. Higher effort is required to apply the brakes and to stop your vehicle. A significant decrease in steering assistance could also occur. The steering does not lock, but higher effort could be required to steer your vehicle. When you switch the ignition off, some electrical circuits, for example airbags, also turn off. If you unintentionally switch the ignition off, shift into neutral (N) and restart the engine.

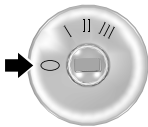

1. Turn the key to position **0**.
2. Shift into neutral and use the brakes to bring your vehicle to a safe stop.
3. Shift into park (P).
4. Apply the parking brake.

STOPPING THE ENGINE WHEN YOUR VEHICLE IS MOVING - VEHICLES WITH: PUSH BUTTON START

WARNING: Switching off the engine when your vehicle is still moving results in a significant decrease in braking assistance. Higher effort is required to apply the brakes and to stop your vehicle. A significant decrease in steering assistance could also occur. The steering does not lock, but higher effort could be required to steer your vehicle. When you switch the ignition off, some electrical circuits, for example airbags, also turn off. If you unintentionally switch the ignition off, shift into neutral (N) and restart the engine.



1. Press and hold the push button ignition switch until the engine stops, or press it three times within two seconds.
2. Shift into neutral and use the brakes to bring your vehicle to a safe stop.
3. Shift into park (P).
4. Apply the parking brake.

AUTOMATIC ENGINE STOP

WHAT IS AUTOMATIC ENGINE STOP

Automatic engine stop is a feature that switches the engine off if it has been idling for an extended period to help you save fuel.

Starting and Stopping the Engine

HOW DOES AUTOMATIC ENGINE STOP WORK

Automatic engine stop turns the engine off. The ignition also turns off in order to save battery power. Before the engine shuts down, a message appears in the information display showing a timer counting down. If you do not intervene within 30 seconds, the engine shuts down. Another message appears in the information display to inform you that the engine has shut down in order to save fuel. Start your vehicle as you normally do.

SWITCHING AUTOMATIC ENGINE STOP ON AND OFF

-  Press the button on the touchscreen.
- Press **Vehicle**.
- Switch **30min Max Idle** on or off.

Note: You cannot permanently switch off the automatic shutdown. If you switch it off, it turns on each time you switch the ignition on.

OVERRIDING AUTOMATIC ENGINE STOP

You can stop the engine shutdown, or reset the timer, at any point before the 30-second countdown has expired by doing any of the following:

- Pressing the brake pedal or accelerator pedal.
- Pressing the **OK** or **RESET** button during the countdown.

Note: You cannot permanently switch off the automatic engine shutdown feature. When you switch it off temporarily, it turns on at the next ignition cycle.

ACCESSING THE PASSIVE KEY BACKUP POSITION - VEHICLES WITH: PUSH BUTTON START

If you are unable to start your vehicle, locate the backup slot at the bottom of the armrest bin.

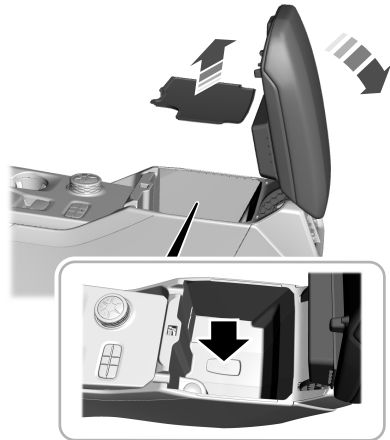

Note: Make sure to place the key properly into the backup slot.

Place the key into the backup slot.

With the key in the backup slot, press the brake pedal, then press the push button ignition switch to start your vehicle.

Starting and Stopping the Engine

STARTING AND STOPPING THE ENGINE – TROUBLESHOOTING

STARTING AND STOPPING THE ENGINE – WARNING LAMPS

Malfunction Indicator Lamp



If it illuminates when the engine is running, the on-board diagnostics system is detecting a malfunction of the vehicle emission control system.

If it flashes, engine misfire could be occurring. Increased exhaust gas temperatures could damage the catalytic converter or other vehicle components. Avoid heavy acceleration and deceleration, and have your vehicle checked as soon as possible.

Powertrain Warning Lamp



If it illuminates when the engine is running, this indicates a powertrain or four-wheel drive fault. If it flashes when you are driving, immediately reduce the vehicle speed. Avoid heavy acceleration and deceleration, and have your vehicle checked as soon as possible.

If both lamps illuminate when the engine is running, stop your vehicle as soon as it is safe to do so. Continuing to drive your vehicle could cause reduced power or the engine to stop. Switch the ignition off and attempt to restart the engine. Have your vehicle checked as soon as possible.

STARTING AND STOPPING THE ENGINE – INFORMATION MESSAGES

Message	Action
Cranking Time Exceeded	Displays if you exceed the starting time limit. You cannot attempt to start the engine for 15 minutes. If you cannot start the engine after 15 minutes passes, have your vehicle immediately checked.
Starting System Fault	Displays if you are unable to start your vehicle with a correctly coded key. The system has detected a fault that requires service. Have your vehicle checked as soon as possible.
No Key Detected	Displays if the system does not detect a valid passive key.

Starting and Stopping the Engine

STARTING AND STOPPING THE ENGINE – FREQUENTLY ASKED QUESTIONS - VEHICLES WITHOUT: PUSH BUTTON START

Why is the engine idle speed high when I am starting the engine?

- The speed at which the engine idles immediately after starting is optimized to minimize vehicle emissions and maximize cabin comfort and fuel economy.

Why does the engine not crank?

- You can only attempt to start the engine for a limited amount of time before the starting system temporarily disables. If you exceed the starting time limit, a message may appear and you cannot attempt to start the engine for at least 15 minutes.

Why do I experience different driving characteristics?

- If you disconnect the battery, your vehicle may exhibit some unusual driving characteristics for approximately 5 mi (8 km) after you reconnect it. This is because the engine management system must realign itself with the engine. You can disregard any unusual driving characteristics during this period.

Why can I not start the engine?

If you cannot start the engine after 3 attempts, wait 10 seconds and do the following:

- Fully press the brake pedal or the clutch pedal.

Note: Make sure that the parking brake is applied.

Note: Make sure that the transmission is in park (P) or neutral (N).

- Fully press the accelerator pedal and hold it there.



- Turn the key to position **III** and wait until the engine stops cranking.
- Release the accelerator pedal.
- Turn the key to position **III**.

STARTING AND STOPPING THE ENGINE – FREQUENTLY ASKED QUESTIONS - VEHICLES WITH: PUSH BUTTON START

Why is the engine speed high when I am starting the engine?

- The speed at which the engine idles immediately after starting is optimized to minimize vehicle emissions and maximize cabin comfort and fuel economy.

Why does the engine not crank?

- You can only attempt to start the engine for a limited amount of time before the starting system temporarily disables. If you exceed the starting time limit, a message may appear and you cannot attempt to start the engine for at least 15 minutes.

Starting and Stopping the Engine

Why do I experience different driving characteristics?

- If you disconnect the battery, your vehicle may exhibit some unusual driving characteristics for approximately 5.0 mi (8 km) after you reconnect it. This is because the engine management system must realign itself with the engine. You can disregard any unusual driving characteristics during this period.

Why can I not start the engine?

If you cannot start the engine after 3 attempts, wait 10 seconds and do the following:

1. Fully press the brake pedal or the clutch pedal.

Note: *Make sure that the parking brake is applied.*

Note: *Make sure that the transmission is in park (P) or neutral (N).*

2. Fully press the accelerator pedal and hold it there.
3. Press the push button ignition switch.

Note: *The engine cranks for a short period of time and then it stops.*

4. Release the accelerator pedal.



5. Press the push button ignition switch.

Why does the system not detect a passive key?

- If the system does not detect a passive key and you are unable to start the engine, insert the passive key into the backup position and press the push button ignition switch to start the engine. See **Accessing the Passive Key Backup Position** (page 175).

Auto-Start-Stop

WHAT IS AUTO-START-STOP

The system helps reduce fuel consumption by stopping and restarting the engine when your vehicle has stopped. The engine restarts when you release the brake pedal.

In some situations, your vehicle could restart before you release the brake pedal, for example:

- To maintain interior comfort.
- To recharge the battery.

AUTO-START-STOP PRECAUTIONS



WARNING: Apply the parking brake, shift into park (P), switch the ignition off and remove the key before you leave your vehicle. Failure to follow this instruction could result in personal injury or death.



WARNING: Apply the parking brake, shift into park (P), switch the ignition off and remove the key before you open the hood or have any service or repair work completed. If you do not switch the ignition off, the engine could restart at any time. Failure to follow this instruction could result in personal injury or death.

SWITCHING AUTO-START-STOP ON AND OFF

The system turns on when you switch the ignition on.



Press the button to switch the system off.

Note: Deactivating the system using the button lasts only one key cycle.

Press the button again to switch the system back on.

STOPPING THE ENGINE

Stop your vehicle, keep your foot on the brake pedal and the transmission in drive (D).

RESTARTING THE ENGINE

Release the brake pedal or press the accelerator pedal.

A message appears in the instrument cluster display if the system requires you to take action.

AUTO-START-STOP INDICATORS



WARNING: The system may require the engine to automatically restart when the auto-start-stop indicator illuminates green or flashes amber. Failure to follow this instruction could result in personal injury.



The Auto-Start-Stop indicator illuminates green when the engine stops. It flashes amber and a message appears when you need to take action.



The Auto-Start-Stop indicator illuminates gray with a strikethrough when the system is turned off.

Note: You can display the reason why the system is not available in the information display.

Auto-Start-Stop

AUTO-START-STOP – TROUBLESHOOTING

AUTO-START-STOP – INFORMATION MESSAGES

A message will appear in the information display if the system requires you to take action.

Automatic Transmission

Message	Condition	Action
Shift to P, then Restart Engine	The system is not functioning.	Shift to park (P) and restart engine.
Auto StartStop Press Brake to Start Engine	The system needs to restart the engine but requires your confirmation.	Press the brake pedal to restart the engine.
Auto StartStop Press a Pedal to Start Engine	The system needs to restart the engine but requires your confirmation.	Press the brake pedal or the accelerator pedal to restart the engine.
Auto StartStop Manual Restart Required	The system is not functioning.	Restart the engine yourself.

Auto-Start-Stop

AUTO-START-STOP – FREQUENTLY ASKED QUESTIONS

Why does the engine not always stop when I expect it to?

The system is designed to work in a way that complements other vehicle systems, allowing them to operate at optimum performance.

The system does not stop the engine if:

- The driver door is open.
- Your vehicle is at high altitude.
- The heated windshield is on.
- The engine is warming up.
- The outside temperature is too low or too high.
- The battery charge is low.
- The battery temperature is outside the optimal operating range.
- The engine is required to run to maintain interior climate and reduce fogging.

Why does the engine sometimes restart when I do not expect it to?

The system is designed to work in a way that complements other vehicle systems, allowing them to operate at optimum performance.

The system restarts the engine if:

- You switch the heated windshield on.
- You switch maximum defrost on.
- Your vehicle starts to roll downhill in neutral.
- The engine is required to run to maintain adequate brake system assistance.
- The engine is required to run to maintain interior climate and reduce fogging.

Can I permanently switch the system off?

No. The system plays an important role in reducing the fuel consumption and the CO₂ emissions.

Will the frequent engine starts cause parts to wear out?

Your vehicle has an enhanced battery and starter motor that are designed for the increased number of engine starts.

Fuel and Refueling

FUEL AND REFUELING PRECAUTIONS



WARNING: Fuels can cause serious injury or death if misused or mishandled.



WARNING: Fuel may contain benzene, which is a cancer-causing agent.



WARNING: Read and follow all the instructions on the pump island.

Follow these guidelines when refueling:

- Extinguish all smoking materials and any open flames before refueling your vehicle.
- Switch the engine off before refueling.
- Automotive fuels can be harmful or fatal if swallowed. Fuel is highly toxic and if swallowed can cause death or permanent injury. If fuel is swallowed immediately call a physician, even if no symptoms are immediately apparent. The toxic effects of fuel may not be apparent for hours.
- Avoid inhaling fuel vapors. Inhaling fuel vapor can lead to eye and respiratory tract irritation. In severe cases, excessive or prolonged breathing of fuel vapor can cause serious illness and permanent injury.
- Avoid getting fuel in your eyes. If you splash fuel in your eyes, immediately remove contact lenses, if worn, flush with water for 15 minutes and seek medical attention. Failure to seek proper medical attention could lead to permanent injury.

- Fuels can be harmful if absorbed through the skin. If you splash fuel on your skin, clothing or both, promptly remove contaminated clothing and thoroughly wash your skin with soap and water. Repeated or prolonged skin contact causes skin irritation.
- Be particularly careful if you are taking Antabuse or other forms of Disulfiram for the treatment of alcoholism. Breathing fuel vapors could cause an adverse reaction, serious personal injury or sickness. Immediately call a physician if you experience any adverse reactions.

FUEL QUALITY

SELECTING THE CORRECT FUEL

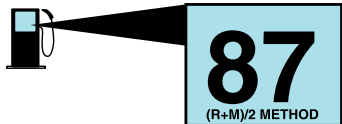

Your vehicle operates on regular unleaded gasoline with a minimum pump (R+M)/2 octane rating of 87.

Some fuel stations, particularly those in high altitude areas, offer fuels posted as regular unleaded gasoline with an octane rating below 87. The use of these fuels could result in engine damage that will not be covered by the vehicle Warranty.

Fuel and Refueling

For best overall vehicle and engine performance, premium fuel with an octane rating of 91 or higher is recommended. The performance gained by using premium fuel is most noticeable in hot weather as well as other conditions, for example when towing a trailer. See **Towing a Trailer** (page 334).

Do not be concerned if the engine sometimes knocks lightly. However, if the engine knocks heavily while using fuel with the recommended octane rating, contact an authorized dealer to prevent any engine damage.

We recommend Top Tier detergent gasolines, where available to help minimize engine deposits and maintain optimal vehicle and engine performance.

For additional information, visit www.toptiergas.com.

Note: *Use of any fuel for which the vehicle was not designed can impair the emission control system, cause loss of vehicle performance, and cause damage to the engine which may not be covered by the vehicle Warranty.*

Do not use:

- Diesel fuel.
- Fuels containing kerosene or paraffin.
- Fuel containing more than 15% ethanol or E85 fuel.
- Fuels containing methanol.
- Fuels containing metallic-based additives, including manganese-based compounds.
- Fuels containing the octane booster additive, methylcyclopentadienyl manganese tricarbonyl (MMT).
- Leaded fuel, using leaded fuel is prohibited by law.

The use of fuels with metallic compounds such as methylcyclopentadienyl manganese tricarbonyl, which is a manganese-based fuel additive, will impair engine performance and affect the emission control system.

LOCATING THE FUEL FILLER FUNNEL

The fuel filler funnel is under the left-hand side rear seat with the vehicle jack.

Crew Cab Models

The fuel filler funnel is behind the right-hand side rear seat with the vehicle jack.

RUNNING OUT OF FUEL

FILLING A PORTABLE FUEL CONTAINER



WARNING: Flow of fuel through a fuel pump nozzle can produce static electricity. This can cause a fire if you are filling an ungrounded fuel container.

Use the following guidelines to avoid electrostatic charge build-up, which can produce a spark, when filling an ungrounded fuel container:

- Only use an approved fuel container to transfer fuel to your vehicle. Place the container on the ground when filling it.
- Do not fill a fuel container when it is inside your vehicle (including the cargo area).
- Keep the fuel pump nozzle in contact with the fuel container when filling it.
- Do not use a device that holds the fuel pump nozzle lever in the fill position.

Fuel and Refueling

ADDING FUEL FROM A PORTABLE FUEL CONTAINER

WARNING: Do not insert the nozzle of a fuel container or an aftermarket funnel into the fuel filler neck. This may damage the fuel system filler neck or its seal and cause fuel to run onto the ground.

WARNING: Do not pry open the fuel tank filler valve. This could damage the fuel system. Failure to follow this instruction could result in fire, personal injury or death.

WARNING: Do not dispose of fuel in the household refuse or the public sewage system. Use an authorized waste disposal facility.

When refueling the vehicle fuel tank from a fuel container, use the fuel filler funnel included with your vehicle. See **Locating the Fuel Filler Funnel** (page 183).

Note: Do not use aftermarket funnels as they may not work with the capless fuel system and can damage it.

When refueling the vehicle fuel tank from a fuel container, do the following:

1. Fully open the fuel filler door.



2. Fully insert the fuel filler funnel into the fuel filler inlet.
3. Add fuel to your vehicle from the fuel container.
4. Remove the fuel filler funnel.
5. Fully close the fuel filler door.
6. Clean the fuel filler funnel and place it back in your vehicle or correctly dispose of it.

Note: If your vehicle runs out of fuel add a minimum of 1.3 gal (5 L) of fuel to restart the engine.

Note: You may need to switch the ignition from off to on several times after refueling to allow the fuel system to pump the fuel from the tank to the engine. When restarting, cranking time takes a few seconds longer than normal.

Note: Extra funnels can be purchased from an authorized dealer if you choose to dispose of the funnel.

Fuel and Refueling

REFUELING

REFUELING SYSTEM OVERVIEW

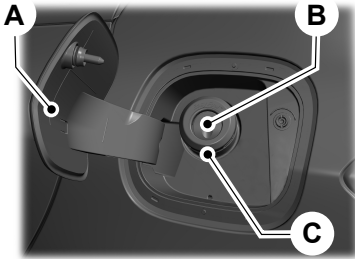

- A Fuel filler door.
- B Fuel filler inlet.
- C Fuel tank filler pipe.

REFUELING YOUR VEHICLE

WARNING: When refueling always shut the engine off and never allow sparks or open flames near the fuel tank filler valve. Never smoke or use a cell phone while refueling. Fuel vapor is extremely hazardous under certain conditions. Avoid inhaling excess fumes.

WARNING: Fuel vapor burns violently and a fuel fire can cause severe injuries.

WARNING: The fuel system may be under pressure. If you hear a hissing sound near the fuel filler inlet, do not refuel until the sound stops. Otherwise, fuel may spray out, which could cause serious personal injury.

WARNING: Keep children away from the fuel pump. Never let children pump fuel.

WARNING: Do not pry open the fuel tank filler valve. This could damage the fuel system. Failure to follow this instruction could result in fire, personal injury or death.

WARNING: Stay outside your vehicle and do not leave the fuel pump unattended when refueling your vehicle.

WARNING: Do not remove the fuel pump nozzle from its fully inserted position when refueling.

WARNING: Stop refueling when the fuel pump nozzle automatically shuts off for the first time. Failure to follow this will fill the expansion space in the fuel tank and could lead to fuel overflowing.

WARNING: Do not overfill the fuel tank. The pressure in an overfilled tank may cause leakage and lead to fuel spray and fire.

WARNING: Wait at least five seconds before removing the fuel pump nozzle to allow any residual fuel to drain into the fuel tank.

1. Fully open the fuel filler door.
2. Select the correct fuel pump nozzle for your vehicle.

Fuel and Refueling

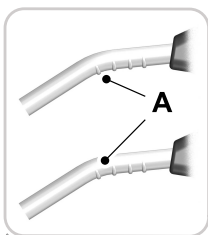

3. Insert the fuel pump nozzle up to the first notch. Keep the fuel pump nozzle resting on the fuel tank filler pipe.

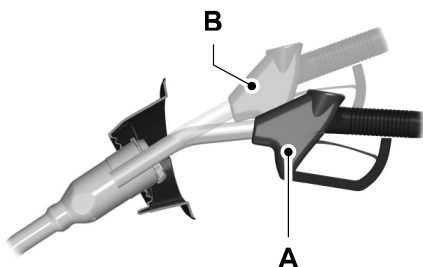

4. Hold the fuel pump nozzle in position A when refueling. Holding the fuel pump nozzle in position B can affect the flow of fuel and shut off the fuel pump nozzle before the fuel tank is full.

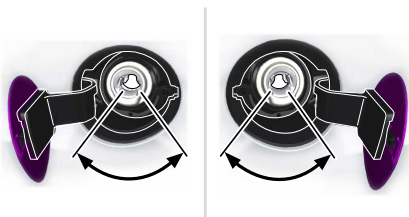

5. Operate the fuel pump nozzle within the area shown.

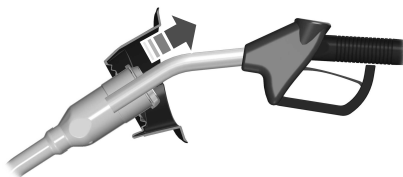

6. When the pump shuts off, wait five seconds, then raise the fuel pump nozzle and slowly remove it.
7. Fully close the fuel filler door.

Note: Do not attempt to start the engine if you have filled the fuel tank with incorrect fuel. Incorrect fuel use could cause damage not covered by the vehicle Warranty. Have your vehicle immediately checked.

FUEL TANK CAPACITY

Advertised Capacity

The advertised capacity is the maximum amount of fuel that you can add to the fuel tank when the fuel gauge indicates empty.

In addition, the fuel tank contains an empty reserve. The empty reserve is an unspecified amount of fuel that remains in the fuel tank when the fuel gauge indicates empty.

Fuel and Refueling

Note: *The amount of fuel in the empty reserve varies and should not be relied upon to increase driving range.*

FUEL AND REFUELING – TROUBLESHOOTING

FUEL AND REFUELING – WARNING LAMPS



If it illuminates when you are driving, refuel as soon as possible.

FUEL AND REFUELING – INFORMATION MESSAGES

Message	Action
Fuel Level Low	An early reminder of a low fuel condition. Refill your vehicle.
Check Fuel Fill Inlet	Check to make sure the fuel fill inlet is fully closed.

Catalytic Converter

WHAT IS THE CATALYTIC CONVERTER

The catalytic converter is part of your vehicle's emissions system and filters harmful pollutants from the exhaust gas.

CATALYTIC CONVERTER PRECAUTIONS



WARNING: Do not park, idle or drive your vehicle on dry grass or other dry ground cover. The emission system heats up the engine compartment and exhaust system, creating the risk of fire.



WARNING: The normal operating temperature of the exhaust system is very high. Never work around or attempt to repair any part of the exhaust system until it has cooled. Use special care when working around the catalytic converter. The catalytic converter heats up to a very high temperature after only a short period of engine operation and stays hot after the engine is switched off.



WARNING: Exhaust leaks may result in entry of harmful and potentially lethal fumes into the passenger compartment. If you smell exhaust fumes inside your vehicle, have your vehicle inspected immediately. Do not drive if you smell exhaust fumes.

To avoid damaging the catalytic converter:

- Do not crank the engine for more than 10 seconds at a time.
- Do not run the engine with a spark plug lead disconnected.
- Do not push-start or tow-start your vehicle. Use booster cables. See **Jump Starting the Vehicle** (page 378).

- Use the correct fuel. See **Fuel and Refueling** (page 182).
- Do not switch the ignition off when your vehicle is moving.
- Avoid running out of fuel.
- Have the items listed in scheduled maintenance information performed according to the specified schedule.

Note: Do not make any unauthorized changes to your vehicle or engine. By law, vehicle owners and anyone who manufactures, repairs, or services a fleet of vehicles are not permitted to intentionally remove an emission control device or prevent it from working.

CATALYTIC CONVERTER – TROUBLESHOOTING

CATALYTIC CONVERTER – WARNING LAMPS

Your vehicle has an on-board diagnostics system that monitors the emission control system. If any of the following warning lamps illuminate, this may indicate that the on-board diagnostics system has detected an emission control system malfunction.



Continuing to drive your vehicle may cause reduced power or the engine to stop. Failure to respond to a warning lamp may cause damage that your vehicle Warranty may not cover. Have your vehicle checked as soon as possible.

Automatic Transmission

AUTOMATIC TRANSMISSION PRECAUTIONS



WARNING: Apply the parking brake, shift into park (P), switch the vehicle off and remove the key or remote control before you leave your vehicle. Failure to follow this instruction could result in personal injury or death.



WARNING: When your vehicle is stationary, keep the brake pedal fully pressed when shifting gears. Failure to follow this instruction could result in personal injury, death or property damage.



WARNING: Do not apply the brake pedal and accelerator pedal simultaneously. Applying both pedals simultaneously for more than a few seconds limits vehicle performance, which may result in difficulty maintaining speed in traffic and could lead to serious injury.

Note: Your vehicle may not shift out of park (P) if a fuse is blown.

Note: Your vehicle may not shift out of park (P) unless the key or remote control is inside your vehicle.

Note: The electronic parking brake could apply when you power your vehicle on with the selector in park (P).

Note: The electronic parking brake could apply if you shift to park (P) without fully pressing the brake pedal.

Note: The electronic parking brake could apply if you shift to park (P) on a slope.

Note: Do not manually release the parking brake when the selector is in park (P). See **Automatically Releasing the Electric Parking Brake** (page 220).

Note: Your vehicle could shift into park (P) if you attempt to exit your vehicle without the vehicle in park (P). See **How Does Automatic Return to Park (P) Work** (page 194).

Note: A tone could sound when you select park (P).

AUTOMATIC TRANSMISSION POSITIONS

PARK (P) - VEHICLES WITH: ELECTRONIC SHIFT



WARNING: Shift into park (P) only when your vehicle is stationary.

In park (P) power is not transmitted to the driven wheels.

Note: A tone sounds if you attempt to exit your vehicle without the vehicle in park (P).

Note: Your vehicle may not shift out of park (P) if the 12 V battery has run out of charge.

PARK (P) - VEHICLES WITH: MECHANICAL SHIFT



WARNING: Shift into park (P) only when your vehicle is stationary.

In park (P) power is not transmitted to the driven wheels.

Note: A tone sounds if you attempt to exit your vehicle without the vehicle in park (P).

Note: Your vehicle may not shift out of park (P) if the 12 V battery has run out of charge.

Note: Your vehicle may not shift out of park (P) if a fuse is blown.

Automatic Transmission

Note: Your vehicle may not shift out of park (P) unless the key or remote control is inside your vehicle.

Note: The electronic parking brake could apply when you power your vehicle on with the selector in park (P).

Note: The electronic parking brake could apply if you shift to park (P) without fully pressing the brake pedal.

Note: The electronic parking brake could apply if you shift to park (P) on a slope.

Note: Do not manually release the parking brake when the selector is in park (P). See **Automatically Releasing the Electric Parking Brake** (page 220).

REVERSE (R)



WARNING: Shift into reverse (R) only when your vehicle is stationary.

In reverse (R) power is transmitted to the driven wheels.

NEUTRAL (N)



WARNING: In neutral (N) your vehicle is free to roll.

In neutral (N) power is not transmitted to the driven wheels.

DRIVE (D)

In drive (D) power is transmitted to the driven wheels.

MANUAL (M) - VEHICLES WITH: ELECTRONIC SHIFT

In manual (M) you can select a specific gear. See **Manually Shifting Gears** (page 191).

Note: We recommend using this mode for driving on hilly or mountainous roads or when towing a trailer. See **Towing a Trailer** (page 334).

MANUAL (M) - VEHICLES WITH: MECHANICAL SHIFT

In manual (M) you can select a specific gear. See **Manually Shifting Gears** (page 191).

Note: We recommend using this mode for driving on hilly or mountainous roads or when towing a trailer. See **Towing a Trailer** (page 334).

SHIFTING YOUR VEHICLE INTO GEAR - VEHICLES WITH: ELECTRONIC SHIFT

The selector is on the center console.

1. Press and hold the brake pedal.
2. Move the lever to select a position.

Note: The position illuminates on the selector.

3. Press the manual (M) button when your vehicle is in drive (D) to enter or exit mode.

SHIFTING YOUR VEHICLE INTO GEAR - VEHICLES WITH: MECHANICAL SHIFT

The selector is on the center console.

1. Press and hold the brake pedal.
2. Move the lever to select a position.

Automatic Transmission

AUTOMATIC TRANSMISSION POSITION INDICATORS

The instrument cluster displays the current position.



Note: The position could illuminate on the transmission selector.

AUTOMATIC TRANSMISSION AUDIBLE WARNINGS - VEHICLES WITH: ELECTRONIC SHIFT

Transmission Not In Park (P) Audible Warning

Sounds if you open the driver door before shifting into park (P).

AUTOMATIC TRANSMISSION AUDIBLE WARNINGS - VEHICLES WITH: MECHANICAL SHIFT

Transmission Not in Park (P) Audible Warning

Sounds if any of the following occur:

- You switch your vehicle off before shifting into park (P).
- You open the driver door before shifting into park (P).

MANUALLY SHIFTING GEARS

SHIFTING USING THE PADDLE SHIFTERS

The instrument cluster displays the current gear. The current gear flashes when your vehicle cannot shift into the requested gear. Your vehicle will not shift if the requested gear raises or lowers the engine speed beyond the limit.

Your vehicle could shift when you fully press the accelerator or brake pedal.

Note: Prolonged driving with high engine speed could cause vehicle damage not covered by the vehicle warranty.

Note: Drive modes could affect when the vehicle shifts into the requested gear.



Manually Shifting Gears in Drive (D)

Use this feature to temporarily change gears.

Note: We recommend using this feature for engine braking or driving on hilly or mountainous roads.

- Pull any paddle to switch the feature on.
- Pull the right (+) paddle to upshift.
- Pull the left (-) paddle to downshift.
- Hold the (+) paddle for a few seconds to switch the feature off.

Automatic Transmission

Note: The feature switches off after a short period of time if you do not pull either paddle.

Manually Shifting Gears in Manual (M)

Use this feature to select a specific gear.

Note: We recommend using this feature for engine braking, driving on hilly or mountainous roads, or when towing a trailer. See **Towing a Trailer** (page 334).

- Shift to manual (M) to switch the feature on.
- Pull the right (+) paddle to upshift.
- Pull the left (-) paddle to downshift.
- Shift to drive (D) to switch the feature off.

SHIFTING USING THE BUTTONS ON THE SELECTOR LEVER - EXCLUDING: RAPTOR

The instrument cluster displays the current gear. The current gear flashes when your vehicle cannot shift into the requested gear. Your vehicle will not shift if the requested gear raises or lowers the engine speed beyond the limit.

Your vehicle could shift when you fully press the accelerator or brake pedal.

Note: Prolonged driving with high engine speed could cause vehicle damage not covered by vehicle warranty.

Note: Drive modes could affect when the vehicle shifts into the requested gear.

Electronic Shifter

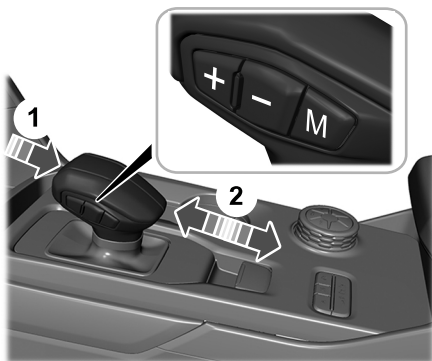

Mechanical Shifter

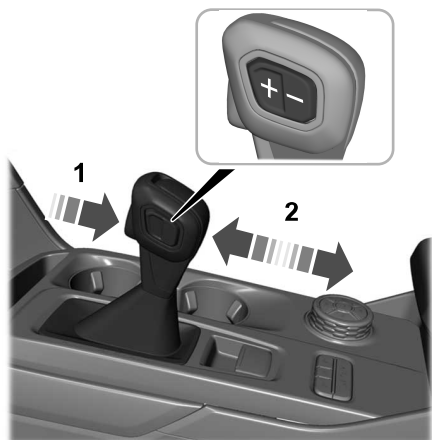

Manually Shifting Gears in Manual (M)

Use this feature to select a specific gear.

Automatic Transmission

Note: We recommend using this feature for engine braking, driving on hilly or mountainous roads, or when towing a trailer. See **Towing a Trailer** (page 334).

Press any button to switch the feature on.

Press the upper (+) button to upshift.

Press the lower (-) button to downshift.

Shift to drive (D) to switch the feature off.

Progressive Range Selection in Drive (D)

Use this feature to prevent your vehicle from automatically shifting to high gears. The instrument cluster displays the current gear and the highest gear available.

Note: Your vehicle automatically shifts within the gear range you select.

Note: We recommend using this feature for engine braking, driving on hilly or mountainous roads, or when towing a trailer. See **Towing a Trailer** (page 334).

- Press the lower (-) button to switch the feature on.
- Press the lower (-) button to disable the next highest gear.
- Hold the upper (+) button for a few seconds to switch the feature off.

TEMPORARY NEUTRAL MODE - VEHICLES WITH: ELECTRONIC SHIFT

HOW DOES TEMPORARY NEUTRAL MODE WORK

Use this mode to keep your vehicle in neutral (N), for a limited time, when you exit your vehicle or switch your vehicle off. For example, if you exit your vehicle before an automatic car wash.

Note: You do not need to use this mode at an automatic car wash if you stay in your vehicle with power on.

Note: Do not tow your vehicle in this mode.

Note: Automatic return to park (P) is delayed when your vehicle is in this mode. See **How Does Automatic Return to Park (P) Work** (page 194).

TEMPORARY NEUTRAL MODE LIMITATIONS

Your vehicle could shift to park (P) after 30 minutes, or when the vehicle battery charge level is low. Prolonged use of this mode can cause the 12 V battery to run out of charge.

This mode could be unavailable if your vehicle is below operating temperature. Warm up your vehicle and attempt the procedure again.

Do not tow your vehicle in this mode. Failure to follow these instructions could result in vehicle damage not covered by the vehicle warranty.

ENTERING TEMPORARY NEUTRAL MODE

1. Bring your vehicle to a complete stop.
2. Press and hold the brake pedal.
3. Power your vehicle on.
4. Shift into neutral (N).

Note: An instructional message appears.

5. Press the manual (M) button.

Note: A confirmation message appears when your vehicle enters the mode.

6. Release the brake pedal.

Note: Your vehicle is free to roll.

7. Switch your vehicle off.

Note: Do not tow your vehicle in this mode.

Automatic Transmission

Note: The neutral (N) indicator on the transmission selector may flash in this mode.

EXITING TEMPORARY NEUTRAL MODE

1. Press the brake pedal.
2. Shift into park (P), or power your vehicle on and shift into drive (D) or reverse (R).

AUTOMATIC RETURN TO PARK (P) - VEHICLES WITH: ELECTRONIC SHIFT

HOW DOES AUTOMATIC RETURN TO PARK (P) WORK

Your vehicle shifts into park (P) if you attempt to exit your vehicle without the vehicle in park (P).

Your vehicle shifts into park (P) when your vehicle is stationary and any of the following occur:

- You switch the vehicle off.
- You open the driver door with the driver seatbelt unfastened.
- You unfasten the driver seatbelt when the driver door is open.

Note: Do not use automatic return to park (P) when your vehicle is moving, except in an emergency. See **Starting and Stopping the Engine** (page 170).

AUTOMATIC RETURN TO PARK (P) LIMITATIONS

Automatic return to park (P) may not work if any of the following occur:

- The driver door ajar sensor is malfunctioning.
- The driver seatbelt sensor is malfunctioning.

See an authorized dealer if any of the following occur:

- Seatbelt indicator illuminates or tone sounds with the driver seatbelt fastened.
- Door ajar indicator does not illuminate with the driver door open.
- Door ajar indicator illuminates with the driver door closed.
- Transmission not in park message appears, with the driver door closed, after you shift out of park (P).

BRAKE SHIFT INTERLOCK - VEHICLES WITH: MECHANICAL SHIFT

WHAT IS BRAKE SHIFT INTERLOCK

Brake shift interlock allows you to shift your vehicle out of park (P) in the event of an electrical malfunction or emergency.

BRAKE SHIFT INTERLOCK PRECAUTIONS



WARNING: Do not drive your vehicle until you verify that the stoplamps are working.

Automatic Transmission



WARNING: When doing this procedure, you need to take the transmission out of park (P) which means your vehicle can roll freely. To avoid unwanted vehicle movement, apply the parking brake prior to doing this procedure. Use wheel chocks if appropriate.



WARNING: If the parking brake is fully released, but the brake warning lamp remains illuminated, the brakes may not be working properly. Have your vehicle checked as soon as possible.

USING BRAKE SHIFT INTERLOCK

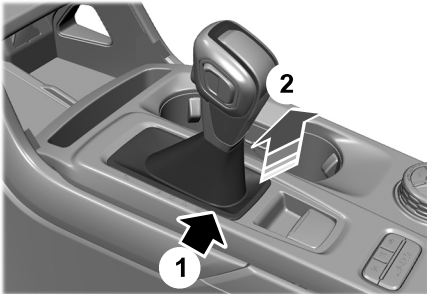

1. Insert a screwdriver between the shifter boot material and trim ring (1) to release the retainer tabs from the top panel trim ring.
2. Lift the shifter boot (2) upward.

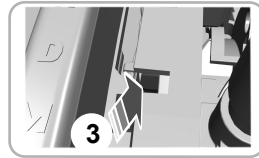
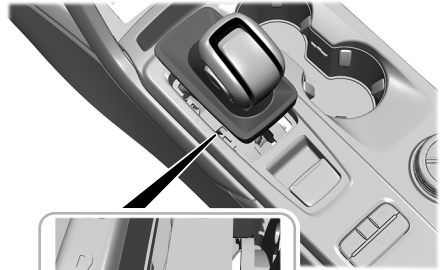

3. Locate the release lever (3) on the side of the transmission selector lever.
4. Using a screwdriver, move the release lever (3) toward the front of the transmission selector lever.
5. When holding the release lever (3) in the forward position, move the transmission selector lever out of the park (P) position and into another gear.

MANUAL PARK RELEASE - VEHICLES WITH: ELECTRONIC SHIFT

WHAT IS MANUAL PARK RELEASE

Manual park release allows you to shift your vehicle out of park (P) in the event of an electrical malfunction or emergency.

Automatic Transmission

MANUAL PARK RELEASE PRECAUTIONS



WARNING: When doing this procedure, you need to take the transmission out of park (P) which means your vehicle can roll freely. To avoid unwanted vehicle movement, always fully apply the parking brake prior to doing this procedure. Use wheels chocks if appropriate.



WARNING: If the parking brake is fully released, but the brake warning lamp remains illuminated, the brakes may not be working properly. Have your vehicle checked as soon as possible.



WARNING: Do not drive your vehicle until you verify that the stoplamps are working.

Use the manual park release to move your transmission from the park (P) position in the event of an electrical malfunction or emergency. See **Emergency Towing** (page 385).

Note: Do not engage the manual park release with the engine on.

USING MANUAL PARK RELEASE

Activating the Manual Park Release Cable

1. Apply the parking brake. See **Electric Parking Brake** (page 219).

Note: If the vehicle battery is dead, an external power source could be required to apply the parking brake.

2. Locate the manual park release cable access cover inside your center console stowage box.

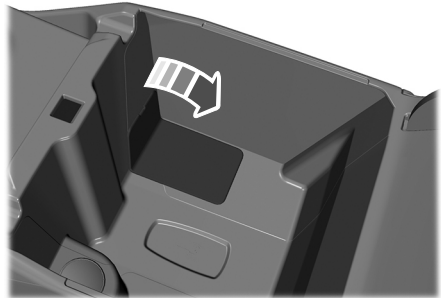

3. Carefully open the hinged access cover using a plastic type wedge or pry tool at the upper edge of the panel.

Note: Do not pull access cover out from console as cover tether could break off.

Note: Do not activate the override lever until you are in the driver seat.

4. Switch ignition on, but do not start your vehicle.
5. Once in the driver seat, fully apply and hold the brake pedal. Do not release. Pull the tether straight out from the console access until engaged. If done correctly, a message appears in the instrument cluster.

Note: Do not use excessive force when using the manual park release handle, as it could result in damage to the handle.

Note: Your vehicle is now out of the park (P) position and is free to roll.

Automatic Transmission

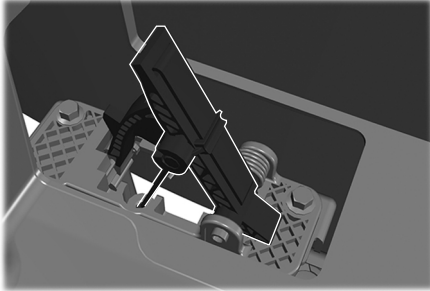
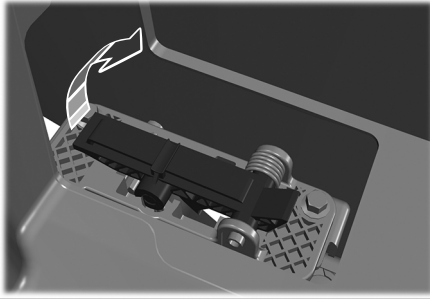

6. With your foot still fully applied on the brake pedal, disengage the parking brake. See **Electric Parking Brake** (page 219).
7. Your vehicle remains in neutral (N) for emergency towing purposes.
8. Switch off the ignition.
9. Once safe to do so, and there is no risk that your vehicle will roll, disconnect the negative (black) battery cable from the battery.

Returning Your Vehicle to Normal Mode

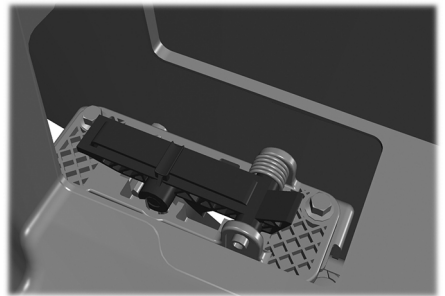
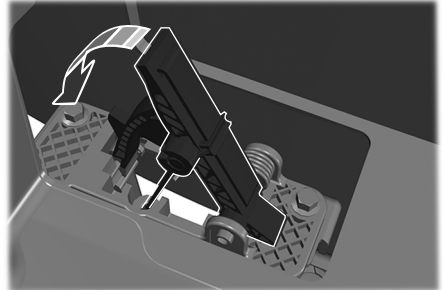

1. Once it is safe to do so, reconnect the negative (black) battery cable to the battery.
2. Apply the parking brake. See **Electric Parking Brake** (page 219).

Note: *If the vehicle battery is dead, an external power may be required to apply the parking brake.*

Note: *Do not pull on the lever until you are in the driver seat.*

3. Once in the driver seat, fully apply and hold the brake pedal, do not release. Pull the tether again to disengage the lever.
4. Return the manual park release lever to the stowed position and install the access cover.

Automatic Transmission

5. With your foot fully applied on the brake pedal, start your vehicle. Confirm that your vehicle is in the park (P) position and the instrument cluster indicates park (P).

Note: *If the instrument cluster is not displaying the park (P) position or the instrument cluster displays an error message, apply the parking brake before exiting your vehicle. Contact an authorized dealer for service.*

6. Close the access cover.

Four-Wheel Drive

HOW DOES FOUR-WHEEL DRIVE WORK - 4X4 WITH PART TIME ENGAGEMENT

4x4 With Part Time Engagement (If Equipped)

This system offers the driver two-wheel drive high, four-wheel drive high, and four-wheel drive low as available modes of operation.

When you select four-wheel drive high or four-wheel drive low, the system provides mechanically locked four-wheel drive power to both the front and rear wheels for use in off-road or slippery conditions such as deep snow, sand or mud.

Selecting four-wheel drive low also provides additional gearing for increased torque multiplication for conditions like deep sand, steep slopes, or pulling heavy objects.

HOW DOES FOUR-WHEEL DRIVE WORK - ADVANCED 4X4 WITH 4A MODE

Advanced 4x4 With Automatic On Demand Engagement (If Equipped)

This system monitors various vehicle sensory inputs to provide an increased level of performance. This system offers the driver two-wheel drive high (2H), four-wheel drive auto (4A), four-wheel drive high (4H) and four-wheel drive low (4L) as available modes of operation.

When you select four-wheel drive auto (4A), the system continuously varies power to the front wheels for optimum performance for all on-road conditions.

When you select four-wheel drive high (4H) or four-wheel drive low (4L), the system provides electronically locked power to the front and rear wheels for use in off-road or slippery conditions such as deep snow, sand or mud.

Selecting four-wheel drive low (4L) also provides additional gearing for increased torque multiplication for conditions like deep sand, steep slopes, or pulling heavy objects.

FOUR-WHEEL DRIVE PRECAUTIONS



WARNING: Vehicles with a higher center of gravity (utility and four-wheel drive vehicles) handle differently than vehicles with a lower center of gravity (passenger cars). Avoid sharp turns, excessive speed and abrupt steering in these vehicles. Failure to drive cautiously increases the risk of losing control of your vehicle, vehicle rollover, personal injury and death.



WARNING: Do not become overconfident in the ability of four-wheel drive vehicles. Although a four-wheel drive vehicle may accelerate better than a two-wheel drive vehicle in low traction situations, it won't stop any faster than two-wheel drive vehicles. Always drive at a safe speed.

Truck and utility vehicles can differ from some other vehicles. Your vehicle could be higher to allow it to travel over rough terrain without getting stuck or damaging underbody components. The differences that make your vehicle so versatile also make it handle differently than an ordinary passenger car. Always maintain steering wheel control, especially in rough terrain. Since sudden changes in terrain can result

Four-Wheel Drive

in abrupt steering wheel motion, make sure you grip the steering wheel from the outside. Do not grip the spokes. Drive cautiously to avoid vehicle damage from concealed objects such as rocks and stumps. Drive slower in strong crosswinds which can affect the normal steering characteristics of your vehicle. Be extremely careful when driving on pavement made slippery by loose sand, water, gravel, snow or ice.

Note: *Do not use four-wheel drive high or four-wheel drive low mode on dry, hard surfaced roads. Doing so can produce excessive noise, increase tire wear and can damage drive components.*

Parking



WARNING: If the parking brake is fully released, but the brake warning lamp remains illuminated, the brakes may not be working properly. Have your vehicle checked as soon as possible.



WARNING: Apply the parking brake, shift into park (P), switch the ignition off and remove the key before you leave your vehicle. Failure to follow this instruction could result in personal injury or death.

On some four-wheel drive vehicles, when the transfer case is in the neutral (N) position, the engine and transmission disconnects from the rest of the driveline. Therefore, your vehicle is free to roll even if the automatic transmission is in park (P). Do not leave the vehicle unattended with the transfer case in the neutral (N) position. Always set the parking brake fully and turn off the ignition when leaving your vehicle.

FOUR-WHEEL DRIVE LIMITATIONS - EXCLUDING: RAPTOR

Do not use four-wheel drive high (4H) or four-wheel drive low (4L) mode on dry, hard surfaced roads. Doing so can produce excessive noise, increase tire wear and damage drive components.

4H or 4L mode is only for use on consistently slippery or loose surfaces. Use of 4L mode on these surfaces could produce some noise, such as occasional clunks, but should not damage drive components.

For vehicles with an electronic shift-on-the-fly transfer case, the driveline could become mechanically blocked when attempting to shift out of a four-wheel drive mode on dry, hard surfaced roads.

Note: *If your vehicle is equipped with the 4x4 part-time selectable engagement transfer case and you are transitioning from consistently loose or slippery surfaces, be sure the four-wheel drive system is not mechanically blocked once you are on dry, hard surfaced roads in two-wheel drive high.*

Note: *In certain scenarios, where the four-wheel drive system has difficulty engaging, a **To Engage 4x4 Slow to 3 MPH** or **To Engage 4x4 Slow to 5 km/h** message could appear in the instrument cluster. This message may also appear when engaging the four-wheel drive system in extreme cold climates at the beginning of the drive cycle. Once the driveline warms up, shifting to four-wheel drive can resume as normal.*

Operating Four-Wheel Drive with a Spare or Mismatched Tires

On four-wheel drive vehicles, the size of the spare tire can affect the four-wheel drive system.

Four-Wheel Drive

If there is a significant difference between the size of the spare tire and the remaining tires, you could have limited four-wheel drive functionality, added noise, discomfort and driveline damage.

Due to normal tire wear, your spare tire is not necessarily the same size as your on-road tires, which makes your spare tire a dissimilar size. Use the spare tire on a limited basis only.

When driving with a dissimilar wheel and tire assembly do not:

- Exceed 50 mph (80 km/h) when operating in a four-wheel drive mode.
- Select a four-wheel drive mode unless the vehicle is stationary.
- Use a four-wheel drive mode on dry pavement.

You could have limited four-wheel drive functionality when driving with a dissimilar wheel and tire assembly, especially when driving in a mechanically locked four-wheel drive mode. You can experience the following:

- Additional noise from the transfer case or other drive components.
- Difficulty shifting in and out of a mechanically locked four-wheel drive mode.
- Driveline component damage.

Note: *When driving with a spare tire, do not switch on four-wheel drive mode unless you need to get your vehicle unstuck.*

Immediately after getting your vehicle unstuck, shift to 2H by performing the following steps:

1. Come to a stop on a flat, horizontal surface.
2. Shift the transmission to park (P) for automatic transmissions and neutral (N) for manual transmissions.
3. Switch to two-wheel drive mode.

4. Shift the transmission to reverse (R).
5. Shift the transmission to drive (D) for automatic transmissions and to first gear for manual transmissions to make sure the transfer case system is not trapped in place.

Mechanical Shift Blocking

On vehicles with an electronic shift-on-the-fly transfer case, the transfer case distributes torque to the front wheels by mechanically interlocking the front and rear driveshafts together. Various external factors can affect shifting performance of this type of system including, but not limited to:

- Vehicle acceleration.
- Dissimilar tire sizes.
- High steering input.

For vehicles with an electronic shift-on-the-fly transfer case, when shifting into two-wheel drive high (2H) on dry, hard surfaced roads, we recommend you preform the following procedure to reduce the likelihood of a mechanical shift block:

1. While driving straight, come to a complete stop on a flat, horizontal surface.
2. Shift the transmission into park (P) for automatic transmissions or press the clutch for vehicles with a manual transmission.
3. Select 2H and wait for the 2H LED to become solid.
4. Shift the transmission into reverse (R) for automatic transmissions or select reverse (R) and release the clutch for vehicles with a manual transmission. Allow the vehicle to roll back approximately 3 ft (1 m) and press the brake.

Four-Wheel Drive

5. Shift the transmission into drive (D) for automatic transmissions or press the clutch in and select a forward gear and release the clutch for vehicles with a manual transmission. Allow the vehicle to roll forward approximately 3 ft (1 m).

If the system is mechanically blocked or if the system detects a mechanical shift block at speed after two-wheel drive high (2H) has been selected, a message can appear momentarily indicating that four-wheel drive is unable to disengage. One or more of the following actions can relieve the mechanical shift block:

- Momentary acceleration.
- Momentary braking.
- Bringing the vehicle to a stop.
- Shifting the transmission to neutral (N) and back to drive (D).
- Shifting the transmission to reverse (R) and back to drive (D).
- Driving the vehicle around a tight turn at a slow speed.

FOUR-WHEEL DRIVE LIMITATIONS - RAPTOR

Do not use four-wheel drive high (4H) or four-wheel drive low (4L) mode on dry, hard surfaced roads. Doing so can produce excessive noise, increase tire wear and damage drive components.

4H or 4L mode is only for use on consistently slippery or loose surfaces. Use of 4L mode on these surfaces could produce some noise, such as occasional clunks, but should not damage drive components.

Operating Four-Wheel Drive with a Spare or Mismatched Tires

On four-wheel drive vehicles, the size of the spare tire can affect the four-wheel drive system.

If there is a significant difference between the size of the spare tire and the remaining tires, you could have limited four-wheel drive functionality, added noise, discomfort and driveline damage.

Due to normal tire wear, your spare tire is not necessarily the same size as your on-road tires, which makes your spare tire a dissimilar size. Use the spare tire on a limited basis only.

When driving with a dissimilar wheel and tire assembly do not:

- Exceed 50 mph (80 km/h) when operating in a four-wheel drive mode.
- Select a four-wheel drive mode unless the vehicle is stationary.
- Use a four-wheel drive mode on dry pavement.

You could have limited four-wheel drive functionality when driving with a dissimilar wheel and tire assembly, especially when driving in a mechanically locked four-wheel drive mode. You can experience the following:

- Additional noise from the transfer case or other drive components.
- Difficulty shifting in and out of a mechanically locked four-wheel drive mode.
- Driveline component damage.

Note: *When driving with a spare tire, do not switch on four-wheel drive mode unless you need to get your vehicle unstuck.*

Immediately after getting your vehicle unstuck, shift to 2H.

Four-Wheel Drive

SWITCHING FOUR-WHEEL DRIVE ON AND OFF

A vehicle that comes with four-wheel drive, when selected, has the ability to use all four wheels to power itself. This increases traction, which may enable you to safely drive over terrain and road conditions that a conventional two-wheel drive vehicle cannot.

On some four-wheel drive models, the initial shift from two-wheel drive to four-wheel drive while the vehicle is moving can cause a momentary clunk and ratcheting sound. These sounds are normal as the front drivetrain comes up to speed and are not cause for concern.

SELECTING A FOUR-WHEEL DRIVE MODE - 4X4 WITH PART TIME ENGAGEMENT

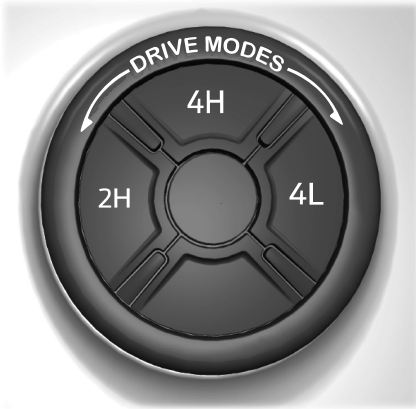

- 2H - Two-wheel drive high.
- 4H - Four-wheel drive high. See **Four-Wheel Drive High** (page 205).
- 4L - Four-wheel drive low. See **Four-Wheel Drive Low** (page 205).

Note: Do not perform this operation if the rear wheels are slipping, while applying the accelerator pedal or when driving in a tight turn.

Note: Momentarily releasing the accelerator pedal while a shift in progress message displays improves engagement or disengagement performance.

Note: Do not perform this operation when cruise control or trail control is selected and active. The system may not shift as expected.

Note: If your vehicle is equipped with a push button four-wheel drive mode selector and the light is solid, the system has achieved the preferred four-wheel drive mode. When a selected four-wheel drive mode light is blinking, the system is attempting to shift to that specific mode.

Shifting to or from Four-Wheel Drive Low

1. Bring your vehicle to a speed of 0 mph (0 km/h).
2. For vehicles with an automatic transmission, place in neutral (N). For vehicles with a manual transmission, fully press the clutch pedal.
3. Push the four-wheel drive mode selector to the preferred four-wheel drive mode.

Note: A **4x4 Shift in Progress** message appears in the instrument cluster display indicating the shift is in progress. If any of the previous shift conditions are not met, the shift does not occur and the instrument cluster display guides the driver through the proper shifting procedures.

Four-Wheel Drive

Note: If **Shift Delayed Drive Forward** displays in the instrument cluster display, place the transmission in a forward gear, move your vehicle forward approximately 5 ft (1.5 m), and shift the transmission back to neutral (N) to allow the transfer case to complete the range shift.

SELECTING A FOUR-WHEEL DRIVE MODE - ADVANCED 4X4 WITH 4A MODE

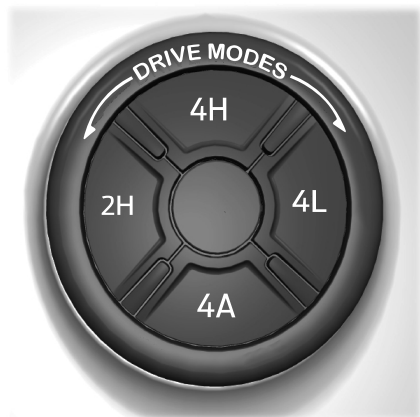

Push the button to select the four-wheel drive mode.

- 2H - Two-wheel drive high.
- 4A - Four-wheel drive auto. See **Four-Wheel Drive Auto** (page 205).
- 4H - Four-wheel drive high. See **Four-Wheel Drive High** (page 205).
- 4L - Four-wheel drive low. See **Four-Wheel Drive Low** (page 205).

Note: Do not perform this operation if the rear wheels are slipping or while applying the accelerator pedal.

Note: When the light is solid, the system has achieved the desired four-wheel drive mode. When a selected four-wheel drive mode LED is blinking, the system is attempting to shift to that specific mode.

Note: When all lights are blinking have your vehicle serviced as soon as possible.

Shifting to or from Four-Wheel Drive Low

1. Bring your vehicle to a speed of 0 mph (0 km/h).
2. For vehicles with an automatic transmission, place in neutral (N). For vehicles with a manual transmission, fully press the clutch pedal.
3. Push the four-wheel drive mode selector to the four-wheel drive mode you prefer.

Note: A **4x4 Shift in Progress** message appears in the instrument cluster display indicating the shift is in progress. If any of the previous shift conditions are not met, the shift will not occur and the instrument cluster display guides you through the proper shifting procedures.

Note: If **Shift Delayed Drive Forward** displays in the instrument cluster display, place the transmission in a forward gear, move your vehicle forward approximately 5 ft (1.5 m), and shift the transmission back to neutral (N) to allow the transfer case to complete the range shift.

FOUR-WHEEL DRIVE MODES

TWO-WHEEL DRIVE HIGH

Two-wheel drive high is for general on-road driving. Power is sent to the rear wheels only.

Note: Two-wheel drive high can turn on or off based on Drive Mode selection. See **Drive Mode Control** (page 278).

Four-Wheel Drive

FOUR-WHEEL DRIVE AUTO - ADVANCED 4X4 WITH 4A MODE

Four-wheel drive auto provides electronically controlled four-wheel drive power to both the front and rear wheels, as required, for increased traction in varying on-road conditions. The four-wheel drive auto tuning varies based on selected Drive Mode. See **Selecting a Drive Mode** (page 279).

Note: *Four-wheel drive auto can turn on or off automatically based on Drive Mode selection. See **Selecting a Drive Mode** (page 279).*

FOUR-WHEEL DRIVE HIGH

Four-wheel drive high provides electronically or mechanically locked four-wheel drive power to both the front and rear wheels for use in off-road or winter conditions such as deep snow, sand or mud. This mode is not for use on dry pavement.

Note: *Four-wheel drive high can turn on or off automatically based on Drive Mode selection. See **Selecting a Drive Mode** (page 279).*

FOUR-WHEEL DRIVE LOW

Four-wheel drive low provides electronically or mechanically locked four-wheel drive power to both the front and rear wheels for use on low traction surfaces, but does so with additional gearing for increased torque multiplication. This mode is only for off-road conditions such as deep sand, steep slopes, or pulling heavy objects.

Note: *Four-wheel drive low can turn on or off automatically based on drive mode selection. See **Selecting a Drive Mode** (page 279).*

FOUR-WHEEL DRIVE INDICATORS

When the indicator lights are solid the system has achieved the desired four-wheel drive mode.

Two-wheel Drive High



Illuminates briefly when you select two-wheel drive high.

Four-wheel Drive Auto (If Equipped)



Illuminates when you select four-wheel drive auto.

Four-wheel Drive High



Illuminates when you select four-wheel drive high.

Four-wheel Drive Low



Illuminates when you select four-wheel drive low.

TRANSFER CASE FLUID CAPACITY AND SPECIFICATION

See **Transfer Case Fluid Capacity and Specification** (page 489).

FOUR-WHEEL DRIVE – TROUBLESHOOTING

FOUR-WHEEL DRIVE – WARNING LAMPS



Illuminates when a four-wheel drive or power train fault is present.

Four-Wheel Drive

Note: When a system fault is present, the system can typically remain in whichever mode was selected prior to the fault condition occurring. It does not default to two-wheel drive in all circumstances. When this warning is displayed, have your vehicle serviced by an authorized dealer.

FOUR-WHEEL DRIVE – INFORMATION MESSAGES

Message	Details
For 4L slow to a stop	Displays when you attempt to shift into four-wheel drive low (4L) when traveling at too high of a speed.
For 4L Shift to N	Displays when you attempt to shift into four-wheel drive low (4L) without the transmission in neutral (N).
To exit 4L slow to a stop	Displays when you attempt to shift out of four-wheel drive low (4L) when traveling at too high of a speed.
To Exit 4L Shift to N	Displays when you attempt to shift out of four-wheel drive low (4L) without the transmission in neutral (N).
4x4 Shift in Progress	Displays when the four-wheel drive system shifts into and out of two-wheel drive high (2H) or between high and low ranges.
4X4 Temporarily Locked	Displays when the four-wheel drive system detects a driving condition that temporarily requires greater four-wheel drive performance. The system resumes normal function after the system no longer detects these driving conditions.
4x4 Temporarily Disabled	Displays when the four-wheel drive system detects an elevated system temperature and temporarily stops providing power to the front wheels. The system resumes normal function when the system temperature returns to normal.
4x4 Restored	Displays when the four-wheel drive system resumes normal function.
Shift Delayed Drive Forward	Displays when the transfer case is not able to complete a shift and requires forward motion to complete the shift.
Shift to Neutral	Displays when the system requires an additional transmission shift to neutral (N) to complete a transfer case shift.

Four-Wheel Drive

Message	Details
4x4 OFF	Displays when the system becomes disabled due to mismatched tires or an external fault.
Selected 4x4 Mode Not Available in Current Drive Mode	Displays when you select a four-wheel drive mode that the system does not allow in the current drive mode.
To Engage 4x4 Slow to 3 MPH	Displays when the system is unable to engage four-wheel drive high (4H) and requires you to slow the vehicle down before attempting to engage.
To Engage 4x4 Slow to 5 km/h	Displays when the system is unable to engage four-wheel drive high (4H) and requires you to slow the vehicle down before attempting to engage.
To Engage 4x4 Release Accelerator Pedal	Displays when the four-wheel drive system requires you to release the accelerator pedal to perform the shift into four-wheel drive mode.
4x4 Performance Reduced See Manual	Displays when the system enters a degraded mode due to mismatched tires.
Check 4x4	A four-wheel drive system fault is present. Have your vehicle checked as soon as possible.
4x4 Unable to Disengage See Manual	Displays when the four-wheel drive system detects a mechanical shift block when shifting out of four-wheel drive high (4H). See Four-Wheel Drive Limitations (page 200).

Electronic Locking Differential

WHAT IS THE ELECTRONIC LOCKING DIFFERENTIAL - EXCLUDING: RAPTOR

The electronic locking differential is a device housed in the rear axle and when activated, allows both wheels on that axle to turn at the same speed. The electronic locking differential can provide additional traction should your vehicle become stuck.

You can activate the electronic locking differential and shift it on the fly within the operating speed range. The electronic locking differential automatically disengages when the vehicle speed exceeds a set value and automatically reengages when the vehicle speed goes below a set value. See **Switching the Electronic Locking Differential On and Off** (page 209). It also automatically engages based on certain selected drive modes. See **Four-Wheel Drive Modes** (page 204).

The electronic locking differential is for use in mud, rocks, sand, or any off-road condition where you need maximum traction. It is not for use on dry pavement.

Note: *The electronic locking differential is for off-road use only and not for use on dry pavement. Using the electronic locking differentials on dry pavement results in increased tire wear, noise and vibration or driveline damage.*

Note: *Switching the electronic locking differential off while turning results in disengagement difficulties. If the electronic locking differential has difficulty disengaging, release the accelerator pedal and turn the steering wheel back and forth in small increments while maintaining control and following a straight line.*

WHAT IS THE ELECTRONIC LOCKING DIFFERENTIAL - RAPTOR

The electronic locking differential is a device housed in the front or rear axle and, when activated allows both wheels on that axle to turn at the same speed. The electronic locking differential can provide additional traction should your vehicle become stuck. You can activate the differential electronically and shift it on the fly within the operating speed range. The electronic differential automatically disengages when the vehicle speed exceeds a set value and it automatically reengages when the vehicle speed goes below a set value. See **Switching the Electronic Locking Differential On and Off** (page 209). It also automatically engages based on certain selected drive modes. See **Four-Wheel Drive Modes** (page 204). The electronic locking differential is for use in mud, rocks, sand, or any off-road condition where you need maximum traction. It is not for use on dry pavement.

Note: *The electronic locking differentials are for off-road use only and not for use on dry pavement. Using the electronic locking differentials on dry pavement results in increased tire wear, noise and vibration or driveline damage.*

Note: *The front electronic locking differential is only available in four-wheel drive low (4L).*

Note: *Locking the front differential reduces your ability to make tight turning maneuvers and creates additional resistance to steering inputs.*

Electronic Locking Differential

Note: Switching the electronic locking differentials off while turning results in disengagement difficulties. If the electronic locking differential has difficulty disengaging, release the accelerator pedal and turn the steering wheel back and forth in small increments while maintaining control and following a straight line.

SWITCHING THE ELECTRONIC LOCKING DIFFERENTIAL ON AND OFF - EXCLUDING: RAPTOR

Activating the Electronic Locking Differential

You can activate the rear electronic locking differential by pressing the switch on the center switch pack or through the touchscreen display. See **Off-Road Screen** (page 370).

Rear Electronic Locking Differential Engagement Speed and Availability

Four-Wheel Drive Modes	Maximum Engagement Speed	Automatic Disengagement Speed	Automatic Re-Engagement Speed
Normal (2H,4A, 4H)	20 mph (32 km/h)	25 mph (41 km/h)	20 mph (32 km/h)
Eco (2H, 4A, 4H)	20 mph (32 km/h)	25 mph (41 km/h)	20 mph (32 km/h)
Sport (2H, 4A, 4H)	20 mph (32 km/h)	25 mph (41 km/h)	20 mph (32 km/h)
Slippery (2H, 4A, 4H)	20 mph (32 km/h)	25 mph (41 km/h)	20 mph (32 km/h)
Deep Snow/Sand (4H, 4L) ¹	No Speed Limit	No Speed Limit	No Speed Limit
Mud/Ruts (4H, 4L) ¹			
Baja (2H, 4H, 4L)			
Rock Crawl (4L) ¹			

¹Automatically engages when you select these drive modes. You have the ability to manually override the automatic engagement by pressing the electronic locking differential switch.

Four-Wheel Drive Modes	Maximum Engagement Speed	Automatic Disengagement Speed	Automatic Re-Engagement Speed
4L	No Speed Limit	No Speed Limit	No Speed Limit

Electronic Locking Differential

Note: Do not perform this operation when cruise control or trail control is selected and active. The system may not engage or disengage as expected.

SWITCHING THE ELECTRONIC LOCKING DIFFERENTIAL ON AND OFF - RAPTOR

Activating the Electronic Locking Differential

You can activate the front or rear locking differential by pressing the switch on the center switch pack or through the touchscreen display. See **Off-Road Screen** (page 370).

Front Electronic Locking Differential Engagement Speed and Availability

Four-Wheel Drive Mode	Maximum Engagement Speed	Automatic Disengagement Speed	Automatic Re-Engagement Speed
4L	20 mph (32 km/h)	25 mph (41 km/h)	20 mph (32 km/h)

Rear Electronic Locking Differential Engagement Speed and Availability

Four-Wheel Drive Modes	Maximum Engagement Speed	Automatic Disengagement Speed	Automatic Re-Engagement Speed
Normal (2H,4A, 4H)	20 mph (32 km/h)	25 mph (41 km/h)	20 mph (32 km/h)
Eco (2H, 4A, 4H)	20 mph (32 km/h)	25 mph (41 km/h)	20 mph (32 km/h)
Sport (2H, 4A, 4H)	20 mph (32 km/h)	25 mph (41 km/h)	20 mph (32 km/h)
Slippery (2H, 4A, 4H)	20 mph (32 km/h)	25 mph (41 km/h)	20 mph (32 km/h)
Deep Snow/Sand (4H, 4L) ¹	No Speed Limit	No Speed Limit	No Speed Limit
Mud/Ruts (4H, 4L) ¹			
Baja (2H, 4H, 4L)			
Rock Crawl (4L) ¹			

¹Automatically engages when you select these drive modes. You have the ability to manually override the automatic engagement by pressing the electronic locking differential switch.

Electronic Locking Differential

Four-Wheel Drive Modes	Maximum Engagement Speed	Automatic Disengagement Speed	Automatic Re-Engagement Speed
4L	No Speed Limit	No Speed Limit	No Speed Limit

ELECTRONIC LOCKING DIFFERENTIAL INDICATORS - EXCLUDING: RAPTOR



Rear electronic locking differential indicator.

If the rear electronic locking differential indicator in the instrument cluster is amber, both wheels of the indicated axle are locked together providing additional traction.

If the rear electronic locking differential is selected and the indicator in the instrument cluster is gray or turns from amber to gray while driving, one of the following has occurred:

- Your vehicle speed is too high.
- The accelerator pedal is too high during an engagement attempt.
- Your vehicle is experiencing an anti-lock brake activation.
- The left and right wheel speed difference is too high during an engagement attempt.

If the rear electronic locking differential is selected and the indicator in the instrument cluster does not illuminate, one of the following has occurred:

- The rear electronic locking differential is not allowed in the current drive mode and is accompanied by **SELECTED LOCKING DIFFERENTIAL NOT AVAILABLE IN CURRENT DRIVE MODE** in the instrument cluster display.
- The rear electronic locking differential is not allowed in the current 4x4 mode and is accompanied by **SELECTED LOCKING DIFFERENTIAL NOT AVAILABLE IN CURRENT 4x4 MODE** in the instrument cluster display.
- The system has malfunctioned and is accompanied by **CHECK LOCKING DIFFERENTIAL** in the instrument cluster display. See your authorized dealer for assistance.
- The rear electronic locking differential was selected above allowable vehicle speed and is accompanied by **TO ENGAGE LOCKING DIFFERENTIAL SLOW TO 20 mph (32 km/h)** in the instrument cluster display.

ELECTRONIC LOCKING DIFFERENTIAL INDICATORS - RAPTOR



Rear locking differential indicator.



Front locking differential indicator.

If the front or rear locking differential indicator in the instrument cluster is amber, both wheels of the indicated axle are locked together providing additional traction.

Electronic Locking Differential

If the electronic locking differential is selected and the indicator in the instrument cluster is gray or turns from amber to gray while driving, one of the following has occurred:

- Your vehicle speed is too high.
- The accelerator pedal is too high during an engagement attempt.
- Your vehicle is experiencing an anti-lock brake activation.
- The left and right wheel speed difference is too high during an engagement attempt.

If the electronic locking differential is selected and the indicator in the instrument cluster does not illuminate, one of the following has occurred:

- The electronic locking differential is not allowed in the current drive mode and is accompanied by **SELECTED LOCKING DIFFERENTIAL NOT AVAILABLE IN CURRENT DRIVE MODE** in the instrument cluster.
- The electronic locking differential is not allowed in the current 4x4 mode and is accompanied by **SELECTED LOCKING DIFFERENTIAL NOT AVAILABLE IN CURRENT 4x4 MODE** in the instrument cluster.
- The system has malfunctioned and is accompanied by **CHECK LOCKING DIFFERENTIAL** in the instrument cluster. See your authorized dealer for assistance.

ELECTRONIC LOCKING DIFFERENTIAL – TROUBLESHOOTING

ELECTRONIC LOCKING DIFFERENTIAL – INFORMATION MESSAGES - EXCLUDING: RAPTOR

Message	Details
Selected Locking Differential Not Available in Current Drive Mode	The selected electronic locking differential is not available in the current drive mode. See Four-Wheel Drive Modes (page 204).
Selected Locking Differential Not Available in Current 4x4 Mode	The selected electronic locking differential is not available in the current four-wheel drive mode. See Four-Wheel Drive Modes (page 204).
To Engage Locking Differential Release Accelerator Pedal	The selected electronic locking differential requires that you release the accelerator pedal in order to engage.
Check Locking Differential	An electronic locking differential system fault is present. See your authorized dealer as soon as possible.
To Engage Locking Differential Slow to 20 mph (32 km/h)	Slow the vehicle to the displayed speed to allow the electronic locking differential to engage.

Electronic Locking Differential

The following conditions affect the electronic locking differential:

- Based on the drive mode selected, the rear electronic locking differential does not engage if your vehicle speed is above 20 mph (32 km/h).
- Based on the drive mode selected, the electronic locking differential automatically disengages at speeds above 25 mph (41 km/h) and automatically re-engages at speeds below 20 mph (32 km/h).
- The electronic locking differential may not engage if you press the accelerator pedal during an engagement attempt. A message may display in the instrument cluster instructing you to release the accelerator pedal.
- The AdvanceTrac system has the ability to take control of the electronic locking differential and disable it during driving maneuvers when necessary.

Operating Electronic Locking Differential With a Spare or Mismatched Tires

On vehicles with an electronic locking differential, the size of the spare tire can affect performance of the system. If there is a significant difference between the two rear tires or two front tires, you may have limited electronic locking differential functionality. If the electronic locking differential has difficulty disengaging, release the accelerator pedal and turn the steering wheel in the opposite direction when rolling. We recommend engaging and disengaging the electronic locking differential at a stop when you mount a spare or mismatched tire on either axle.

ELECTRONIC LOCKING DIFFERENTIAL – INFORMATION MESSAGES - RAPTOR

Message	Details
Selected Locking Differential Not Available in Current Drive Mode	The selected electronic locking differential is not available in current drive mode. See Four-Wheel Drive Modes (page 204).
Selected Locking Differential Not Available in Current 4x4 Mode	The selected electronic locking differential is not available in your current four-wheel drive mode. See Four-Wheel Drive Modes (page 204).
To Engage Locking Differential Release Accelerator Pedal	The selected electronic locking differential requires that you release the accelerator pedal in order to engage.
Check Locking Differential	An electronic locking differential system fault is present. See your authorized dealer as soon as possible.

The following conditions affect the electronic locking differential:

Electronic Locking Differential

- Based on drive mode selection, the rear electronic locking differential does not engage if your vehicle speed is above 20 mph (32 km/h).
 - The front electronic locking differential does not engage if your vehicle speed is above 20 mph (32 km/h) in four-wheel drive low (4L).
 - Based on drive mode selection, the electronic locking differential automatically disengages at speeds above 25 mph (41 km/h) and automatically re-engages at speeds below 20 mph (32 km/h).
 - The electronic locking differential may not engage if you press your accelerator pedal during an engagement attempt. A message may display in the instrument display guiding you to release the accelerator pedal.
 - In four-wheel drive low (4L), the front electronic locking differential automatically disengages at speeds above 25 mph (41 km/h) and automatically re-engages at speeds below 20 mph (32 km/h).
 - The AdvanceTrac system has the ability to take over control of the electronic locking differential and disable it during driving maneuvers when necessary.
- release the accelerator pedal and turn the steering wheel in the opposite direction when rolling. We recommend engaging and disengaging the electronic locking differential at a stop when you mount a spare or mismatched tire on either axle.

Operating Electronic Locking Differential With a Spare or Mismatched Tires

On vehicles with an electronic locking differential, the size of the spare tire can affect performance of the system. If there is a significant difference between the two rear tires or two front tires, you may have limited electronic locking differential functionality. If the electronic locking differential has difficulty disengaging,

Brakes

BRAKE PRECAUTIONS

Wet brakes result in reduced braking efficiency. Gently press the brake pedal a few times when leaving a car wash or driving from standing water to dry the brakes.

Note: *Depending on applicable laws and regulations in the country where your vehicle was originally built, the stoplamps could flash during heavy braking. The hazard warning flashers could also turn on when your vehicle comes to a stop.*

ANTI-LOCK BRAKING SYSTEM

ANTI-LOCK BRAKING SYSTEM LIMITATIONS

The anti-lock braking system does not eliminate the risk of crash when:

- You drive too closely to the vehicle in front of you.
- Your vehicle is hydroplaning.
- You take corners too fast.
- The road surface is poor.

Note: *If the system activates, the brake pedal could pulse and travel further. Maintain pressure on the brake pedal.*

ANTI-LOCK BRAKING SYSTEM INDICATORS

This system helps you maintain steering control during emergency stops by keeping the brakes from locking.



If the warning lamp illuminates when you are driving, this indicates a malfunction. Your vehicle continues to have normal braking without the anti-lock brake system function. Have your vehicle checked as soon as possible.

The warning lamp also momentarily illuminates when you switch the ignition on to confirm the lamp is functional. If it does not illuminate when you switch the ignition on, or begins to flash at any time, have the system checked by an authorized dealer.



The warning lamp illuminates when you engage the parking brake and the ignition is on. If it illuminates when your vehicle is moving, make sure the parking brake is disengaged. If the parking brake is disengaged, this indicates low brake fluid level or a brake system fault. Have your vehicle checked as soon as possible.

The warning lamp also momentarily illuminates when you switch the ignition on to confirm the lamp is functional. If it does not illuminate when you switch the ignition on, or begins to flash at any time, have the system checked by an authorized dealer.

BRAKE OVER ACCELERATOR

In the event the accelerator pedal becomes stuck or entrapped, apply steady and firm pressure to the brake pedal to slow the vehicle and reduce engine power. If you experience this condition, apply the brakes and bring your vehicle to a safe stop. Move the transmission to park (P), switch the engine off and apply the parking brake. Inspect the accelerator pedal for any interference. If none are found and the condition persists, have your vehicle towed to the nearest authorized dealer.

LOCATING THE BRAKE FLUID RESERVOIR

See **Under Hood Overview** (page 403).

Brakes

CHECKING THE BRAKE FLUID



WARNING: Do not use any fluid other than the recommended brake fluid as this will reduce brake efficiency. Use of incorrect fluid could result in the loss of vehicle control, serious personal injury or death.



WARNING: Only use brake fluid from a sealed container. Contamination with dirt, water, petroleum products or other materials may result in brake system damage or failure. Failure to adhere to this warning could result in the loss of vehicle control, serious personal injury or death.



WARNING: Do not allow the fluid to touch your skin or eyes. If this happens, rinse the affected areas immediately with plenty of water and contact your physician.



WARNING: The brake system could be affected if the brake fluid level is below the **MIN** mark or above the **MAX** mark on the brake fluid reservoir.



1. Park your vehicle on a level surface.
2. Look at the brake fluid reservoir to see where the brake fluid level is relative to the **MIN** and the **MAX** marks on the reservoir.

Note: To avoid fluid contamination, the reservoir cap must remain in place and fully tight, unless you are adding fluid.

Only use fluid that meets our specifications. See **Capacities and Specifications** (page 471).

BRAKE FLUID SPECIFICATION

See **Brake Fluid Specification** (page 488).

Brakes

BRAKES – TROUBLESHOOTING

BRAKES – WARNING LAMPS



WARNING: Driving your vehicle with the warning lamp on is dangerous. A significant decrease in braking performance may occur. It may take you longer to stop your vehicle. Have your vehicle checked as soon as possible. Driving extended distances with the parking brake engaged can cause brake failure and the risk of personal injury.



If the ABS indicator illuminates when you are driving, this indicates a malfunction. Your vehicle continues to have normal braking without the anti-lock braking system function. See an authorized dealer.

It also momentarily illuminates when you switch the ignition on to confirm the lamp is functional. If it does not illuminate when you switch the ignition on, or begins to flash at any time, have the system checked by an authorized dealer.

BRAKE



The brake indicator momentarily illuminates when you switch the ignition on to confirm the lamp is functional. It may also illuminate when you apply the parking brake and the ignition is on. If it illuminates when your vehicle is moving, make sure the parking brake is disengaged. If the parking brake is disengaged, this indicates low brake fluid level or a brake system fault. See an authorized dealer.

BRAKES – INFORMATION MESSAGES

Message	Details
Brake Fluid Level Low	The brake fluid level is low, check the brake system immediately. See Checking the Brake Fluid (page 216).
Check Brake System	Have the system checked as soon as possible.

Brakes

BRAKES – FREQUENTLY ASKED QUESTIONS

Is it normal for my brakes to make noise?

Occasional brake noise is normal. If a metal-to-metal, continuous grinding, or squeal sound is present, the brake lining could be worn. Have the system checked.

There is an electrical motor sound when I press on the brake pedal or activate the park brake switch. Is this normal?

Yes, those sounds are the electronic brake booster or the electronic park brake operating.

Note: *Brake dust could accumulate on the wheels, even under normal driving conditions. Some dust is normal as the brakes wear and does not contribute to brake noise. See **Cleaning Wheels** (page 426).*

Electric Parking Brake

WHAT IS THE ELECTRIC PARKING BRAKE

The electric parking brake is used to hold your vehicle on slopes and flat roads.

APPLYING THE ELECTRIC PARKING BRAKE



WARNING: Apply the parking brake and make sure your vehicle is in park (P). Power the vehicle off and remove the keys or remote control whenever you leave your vehicle. Failure to follow this instruction could result in personal injury or death.



WARNING: If you drive extended distances with the parking brake applied, you could cause damage to the brake system.



WARNING: The electric parking brake does not operate if the vehicle battery has run out of charge.



WARNING: If the parking brake is fully released, but the brake warning lamp remains illuminated, the brakes may not be working properly. Have your vehicle checked as soon as possible.



The electric parking brake switch is on the center console.

1. Pull the switch up.

The red warning lamp flashes during operation and illuminates when the parking brake is applied.

Note: You can apply the electric parking brake when the ignition is off.

Note: The electric parking brake could apply when you shift into park (P). See **Park (P)** (page 189).

APPLYING THE ELECTRIC PARKING BRAKE IN AN EMERGENCY

You can use the electric parking brake to slow or stop your vehicle in an emergency.

Pull the switch up and hold it.

The red warning lamp illuminates, a tone sounds and the stoplamps turn on when you use the electric parking brake in an emergency.

The electric parking brake continues to slow your vehicle down unless you release the switch.

Note: Do not apply the electric parking brake when your vehicle is moving, except in an emergency. If you repeatedly use the electric parking brake to slow or stop your vehicle, you could cause damage to the brake system.

MANUALLY RELEASING THE ELECTRIC PARKING BRAKE

1. Switch the ignition on.
2. Press and hold the brake pedal.
3. Push the switch down.

The red warning lamp turns off.

Pulling Away on a Hill When Towing a Trailer

1. Press and hold the brake pedal.
2. Pull the switch upward and hold it.
3. Shift into gear.

Electric Parking Brake

4. Press the accelerator pedal until engine has developed sufficient torque to prevent your vehicle from rolling down the hill.
5. Release the switch and pull away in a normal manner.

AUTOMATICALLY RELEASING THE ELECTRIC PARKING BRAKE

1. Close the driver door.
2. Shift into gear.
3. Press the accelerator pedal and pull away in a normal manner.

ELECTRIC PARKING BRAKE AUDIBLE WARNING

Sounds when the parking brake is on and your vehicle is moving. If the warning tone continues after you have released the parking brake, this indicates a malfunction. Have your vehicle checked as soon as possible.

RELEASING THE ELECTRIC PARKING BRAKE IF THE VEHICLE BATTERY HAS RUN OUT OF CHARGE



WARNING: The electric parking brake does not operate if the vehicle battery has run out of charge.

Connect a booster battery to the vehicle battery to release the electric parking brake if the vehicle battery has run out of charge. See **Jump Starting the Vehicle** (page 378).

ELECTRIC PARKING BRAKE – TROUBLESHOOTING

ELECTRIC PARKING BRAKE – WARNING LAMPS

Brake System



It illuminates red when you apply the parking brake and your vehicle is on. If the lamp flashes when the parking brake has been released, this indicates the parking brake system requires service. Have your vehicle checked as soon as possible.

Note: Lamps may vary depending on region.

Electric Parking Brake



When the lamp illuminates yellow, it indicates a malfunction in the electric parking brake.

Have your vehicle checked as soon as possible.

Note: Lamps may vary depending on region.

Electric Parking Brake

ELECTRIC PARKING BRAKE – INFORMATION MESSAGES

Parking Brake

Message	Details
Park Brake On	The electric parking brake is fully applied.
Park Brake Off	The electric parking brake is fully released.
Park Brake System Overheated	The electric parking brake system has detected a condition where components may have been subject to overheating. Contact an authorized dealer.
To Release: Press Brake and Switch	The electric parking brake is set and you attempted a manual release without pressing the brake.
Park Brake Use Switch to Release	With the electric parking brake set, you attempted an automatic release with no success. Perform a manual release.
Release Park Brake	The electric parking brake is set and your vehicle speed exceeds 3 mph (5 km/h). Release the parking brake before continued driving.
Park Brake Not Applied	The electric parking brake is not fully applied.
Park Brake Not Released	The electric parking brake is not fully released.
Park Brake Maintenance Mode	The electric parking brake system has been put into a special mode to allow rear brake service. Contact an authorized dealer.
Park Brake Limited Function Service Required	The electric parking brake system has detected a condition that requires service. Some functionality may still be available. Contact an authorized dealer.
Park Brake Malfunction Service Now	The electric parking brake system has detected a condition that requires service. Contact an authorized dealer.

ELECTRIC PARKING BRAKE – FREQUENTLY ASKED QUESTIONS

Pulling Away on a Hill When Towing a Trailer

Press and hold the brake pedal.



Pull the switch upward and hold it.

Shift into gear.

Press the accelerator pedal until engine has developed sufficient torque to prevent your vehicle from rolling down the hill.



Release the switch and pull away in a normal manner.

Reverse Brake Assist (If Equipped)

WHAT IS REVERSE BRAKE ASSIST

Reverse brake assist is designed to reduce impact damage or assist in avoiding a collision while in reverse (R). Using sensors on the rear of the vehicle, it can detect a possible collision and apply the brakes. If full braking occurs, the system attempts to stop the vehicle a safe distance from the obstacle.

HOW DOES REVERSE BRAKE ASSIST WORK

Reverse brake assist functions when in reverse (R) and traveling at a speed of 1–7 mph (2–12 km/h).

If the system detects an obstacle behind your vehicle, it provides a warning through the rear parking aid or cross traffic alert system.

REVERSE BRAKE ASSIST PRECAUTIONS



WARNING: You are responsible for controlling your vehicle at all times. The system is designed to be an aid and does not relieve you of your responsibility to drive with due care and attention. Failure to follow this instruction could result in the loss of control of your vehicle, personal injury or death.



WARNING: To help avoid personal injury, always use caution when in reverse (R) and when using the sensing system.



WARNING: The system may not operate properly during severe weather conditions, for example snow, ice, heavy rain and spray. Always drive with due care and attention. Failure to take care may result in a crash.



WARNING: Traffic control systems, fluorescent lamps, inclement weather, air brakes, external motors and fans may affect the correct operation of the sensing system. This may cause reduced performance or false alerts.



WARNING: Some situations and objects prevent hazard detection. For example low or direct sunlight, inclement weather, unconventional vehicle types, and pedestrians. Apply the brakes when necessary. Failure to follow this instruction could result in the loss of control of your vehicle, personal injury or death.



WARNING: Do not use the system with accessories that extend beyond the front or rear of your vehicle, for example a trailer hitch or bike rack. The system is not able to make corrections for the additional length of the accessories.

The system only applies the brakes for a short period of time when an event occurs. Act as soon as you notice the brakes apply to remain in control of the vehicle. If you do not intervene the vehicle may start to move again.

Note: Certain add-on devices around the bumper or fascia may create false alerts. For example, large trailer hitches, bicycle or surfboard racks, license plate brackets, bumper covers or any other device that may block the normal detection zone of the system. Remove the add-on device to prevent false alerts.

Reverse Brake Assist (If Equipped)

Note: The system does not react to small or moving objects, particularly those close to the ground.

Note: The system does not operate during hard acceleration or steering.

Note: If your vehicle sustains damage to the bumper or fascia leaving it misaligned or bent, it could alter the sensing zone causing inaccurate measurement of obstacles or false alerts.

Note: Vehicle loading and suspension changes can impact the angle of the sensors and may change the normal detection zone of the system resulting in inaccurate measurement of obstacles or false alerts.

Note: When you connect a trailer, the system may detect the trailer and provide an alert, or the system turns off. If the system does not turn off, manually switch the system off after you connect the trailer.

Note: You may experience reduced system performance on road surfaces that limit deceleration. For example, roads with ice, loose gravel, mud or sand.

SWITCHING REVERSE BRAKE ASSIST ON AND OFF

1.



Press the button on the touchscreen.

2. Press **Driver Assistance**.

3. Switch **Reverse Brake Assist** on or off.

Note: The system is unavailable when the rear parking aid or cross traffic alert is off.

Note: If your vehicle is not equipped with cross traffic alert the reverse brake assist relies on input from the rear parking aid and rear view camera sensors.

OVERRIDING REVERSE BRAKE ASSIST

There could be instances when unexpected or unwanted braking occurs. Firmly pressing the accelerator pedal or switching the feature off overrides the system.

REVERSE BRAKE ASSIST INDICATORS

If the system determines that a collision with an obstacle may occur, full braking may apply.



A message and warning indicator appear when the system applies the brakes.

Reverse Brake Assist (If Equipped)

REVERSE BRAKE ASSIST – TROUBLESHOOTING

REVERSE BRAKE ASSIST – INFORMATION MESSAGES

Message	Description
Reverse Brake Assist	Displays when the system applies the brakes and remains on for a few seconds.
Reverse Brake Assist Not Available See Manual	Displays when a related subsystem or feature error has occurred. Make sure the rear view camera and side cameras are clean and not obstructed. Drive the vehicle on a straight road for a short period. If the message remains on, have the system checked as soon as possible.
Reverse Brake Assist Fault	Displays when a system error has occurred. Have your vehicle checked as soon as possible.
Reverse Brake Assist Off	Displays when reverse brake assist is off.

Reverse Brake Assist (If Equipped)

REVERSE BRAKE ASSIST – FREQUENTLY ASKED QUESTIONS

Why is reverse brake assist unavailable?

- Make sure the reverse brake assist is on. See **Switching Reverse Brake Assist On and Off** (page 223).
- Make sure that all doors, liftgate or tailgate and hood are closed. Drive the vehicle on a straight road for a short period. If the message remains, have the system checked.
- If your vehicle has the cross traffic alert system, make sure it is on. See **Switching Cross Traffic Alert On and Off** (page 308).
- Make sure the rear parking aid system is on. See **Parking Aids** (page 243).
- Your vehicle may have sustained a rear end impact. Have the sensors checked for proper coverage and operation.
- Make sure the rear view camera and side cameras are not dirty or obstructed. If dirty, clean the cameras. If the message remains after cleaning the cameras, wait a short time for the message to clear. If the message does not clear, drive the vehicle on a straight road for a short period. If the message still appears, have your system checked.
- Make sure the cross traffic alert, rear parking aid and side parking aid sensors are not blocked or faulty. See **Locating the Cross Traffic Alert Sensors** (page 308). See **Locating the Rear Parking Aid Sensors** (page 244). See **Locating the Side Parking Aid Sensors** (page 246).
- You recently had your vehicle serviced, or the battery disconnected. Drive your vehicle a short distance to resume system operation.

- Reverse brake assist does not function when you connect a trailer. Operation resumes when you disconnect the trailer.

Note: *If the answers to why the system is unavailable do not assist in returning reverse brake assist to available, have the system checked as soon as possible.*

Hill Start Assist

WHAT IS HILL START ASSIST

Hill Start Assist makes it easier for you to pull away when your vehicle is on a slope without using the parking brake.

HOW DOES HILL START ASSIST WORK

When the system activates, your vehicle remains stationary for a few seconds after you release the brake pedal. This gives you time to move your foot from the brake pedal to the accelerator pedal. The brakes release when you apply the accelerator pedal and the vehicle begins to move forward, or the vehicle is stationary beyond the Hill Start Assist hold time.

The system activates when your vehicle is in any forward gear and facing uphill, or when your vehicle is in reverse (R) and facing downhill.

HILL START ASSIST PRECAUTIONS



WARNING: The system does not replace the parking brake. When you leave your vehicle, always apply the parking brake.



WARNING: You must remain in your vehicle when the system turns on. At all times you are responsible for controlling your vehicle, supervising the system, and intervening if required. Failure to follow this instruction could result in the loss of control of your vehicle, personal injury or death.



WARNING: The system turns off if there is a malfunction.

SWITCHING HILL START ASSIST ON AND OFF

Hill start assist is active when you switch the ignition on. You cannot switch the system on or off.

HILL START ASSIST – TROUBLESHOOTING

HILL START ASSIST – INFORMATION MESSAGES

Message	Details
Hill Start Assist Not Available	Displays when system is not available. Have your vehicle checked as soon as possible.

Auto Hold

HOW DOES AUTO HOLD WORK

Auto hold applies the brakes to hold your vehicle after you bring the vehicle to a stop. This can help when waiting on a hill or in traffic.

SWITCHING AUTO HOLD ON AND OFF



WARNING: The system does not replace the parking brake. When you leave your vehicle, always apply the parking brake.



WARNING: You must remain in your vehicle when the system turns on. At all times, you are responsible for controlling your vehicle, supervising the system and intervening, if required. Failure to take care may result in the loss of control of your vehicle, serious personal injury or death.

You can switch the system on or off by accessing the menu on the touchscreen.

1. Press **Settings** on the touchscreen.
2. Press **Driver Assistance**.

Note: You can only switch the system on after you close the driver door and fasten your seatbelt.

Note: The system remembers the last setting when you start your vehicle.

Note: When using an automatic car wash, make sure to switch auto hold off, or shift to neutral (N) with the brake pedal applied to ensure auto hold is not active.

USING AUTO HOLD

1. Bring your vehicle to a complete stop. The auto hold active indicator illuminates in the information display.
2. Release the brake pedal. The system holds your vehicle at a standstill. The auto hold active indicator remains illuminated in the information display.
3. Apply the accelerator and drive off in a normal manner. The system releases the brakes and the auto hold active indicator switches off.

Note: The system only activates if you apply enough brake pressure on the brake pedal to bring the vehicle to a standstill.

Note: Under certain conditions, the system could apply the electric parking brake. The brake system warning lamp illuminates. The electric parking brake releases when you press the accelerator pedal. See **Automatically Releasing the Electric Parking Brake** (page 220).

Note: The system switches off if you shift into reverse (R) or neutral (N) while pressing the brake pedal.

There could be actions that can cause the auto hold system not to work when the following occur:

- When you use active park assist.
- Your vehicle is in stay in neutral mode.
- The driver door is open.
- You shift into reverse (R) or neutral (N) before the system is active.

AUTO HOLD INDICATORS



Illuminates when the system is active.

Auto Hold



Illuminates when the system is on but cannot hold your vehicle at a standstill at this particular time.

Traction Control

WHAT IS TRACTION CONTROL

The traction control system helps to avoid drive wheel spin and loss of traction.

HOW DOES TRACTION CONTROL WORK

If your wheels begin to spin, the loss of traction can compromise steering control and stability of the vehicle. The traction control system applies the brakes to individual wheels and when needed, reduces engine power at the same time to increase traction.

SWITCHING TRACTION CONTROL ON AND OFF



WARNING: Operating your vehicle with the traction control disabled could lead to an increased risk of loss of vehicle control, vehicle rollover, personal injury and death.

The system turns on each time you switch the ignition on.

If your vehicle is stuck in mud or snow, switching traction control off may be beneficial as this allows the wheels to spin.

Switching the System Off



The switch for the stability and traction control system is on the center console.

When you switch the system off, a message and an illuminated icon appear on the instrument cluster.

Use the switch again to return the traction control system to normal operation.

Note: When you switch traction control off, stability control remains fully active.

Note: When you place your vehicle into four-wheel drive low (4L), the traction control disables. Traction control resumes when you put your vehicle back into two-wheel drive or four-wheel drive high (4H).

Note: For additional information on the traction and stability control systems. See **Stability Control** (page 231).

TRACTION CONTROL INDICATOR

Stability and Traction Control Indicator



If the indicator does not illuminate when you switch the ignition on, or remains on when the engine is running, this indicates a malfunction. Have your vehicle checked by an authorized dealer as soon as possible.



The traction control off indicator illuminates when you switch the traction control system off, or when an alternative stability control mode is selected that requires the traction control off depending on the drive mode selected.

Traction Control

TRACTION CONTROL – TROUBLESHOOTING

TRACTION CONTROL – WARNING LAMPS

System Messages



The traction control light temporarily illuminates on

start-up and flashes when activated by a driving condition.

The traction control off light temporarily illuminates on start-up and stays on:

- When you switch the traction control system off.
- When you select an alternative stability control mode.
- If a problem occurs in the system.

TRACTION CONTROL – INFORMATION MESSAGES

Message	Action
Traction Control Off	The status of the traction control system after you switched it off.
Traction Control On	The status of the traction control system after you switched it on.

Stability Control

HOW DOES STABILITY CONTROL WORK



WARNING: Vehicle modifications involving braking system, aftermarket roof racks, suspension, steering system, tire construction and wheel and tire size may change the handling characteristics of your vehicle and may adversely affect the performance of the electronic stability control system. In addition, installing any stereo loudspeakers may interfere with and adversely affect the electronic stability control system. Install any aftermarket stereo loudspeaker as far as possible from the front center console, the tunnel, and the front seats in order to minimize the risk of interfering with the electronic stability control sensors. Reducing the effectiveness of the electronic stability control system could lead to an increased risk of loss of vehicle control, vehicle rollover, personal injury and death.



WARNING: Remember that even advanced technology cannot defy the laws of physics. It's always possible to lose control of a vehicle due to inappropriate driver input for the conditions. Aggressive driving on any road condition can cause you to lose control of your vehicle increasing the risk of personal injury or property damage. Activation of the electronic stability control system is an indication that at least some of the tires have exceeded their ability to grip the road; this could reduce the operator's ability to control the vehicle potentially resulting in a loss of vehicle control, vehicle rollover, personal injury and death. If your electronic stability control system activates, SLOW DOWN.

If a driving condition activates either the stability control or the traction control system you may experience the following conditions:

- The stability and traction control light flashes.
- Your vehicle slows down.
- Reduced engine power.

The stability control system has several features built into it to help you maintain control of your vehicle:

Electronic Stability Control

Electronic stability control enhances your vehicle's ability to prevent skids or lateral slides by applying brakes to one or more of the wheels individually and, if necessary, reducing engine power.

Roll Stability Control

Roll stability control enhances your vehicle's ability to prevent rollovers by detecting your vehicle's roll motion and the rate at which it changes by applying the brakes to one or more wheels individually.

Curve Control

Curve control enhances your vehicle's ability to follow the road when cornering severely or avoiding objects in the roadway. Curve control operates by reducing engine power and, if necessary, applying brakes to one or more of the wheels individually.

Traction Control

Traction control enhances your vehicle's ability to maintain traction of the wheels by detecting and controlling wheel spin. See **How Does Traction Control Work** (page 229).

Stability Control

- B Vehicle with stability control maintaining control on a slippery surface.

SWITCHING STABILITY CONTROL ON AND OFF

Stability Control turns on each time you switch the ignition on.

You can switch the stability control off by pressing and holding the stability and traction control button off for 5-15 seconds, or you can press the button again to switch the system on.

Shifting the transmission into reverse (R) will disable the system.

You can switch the traction control system off or on independently. See **Switching Traction Control On and Off** (page 229).

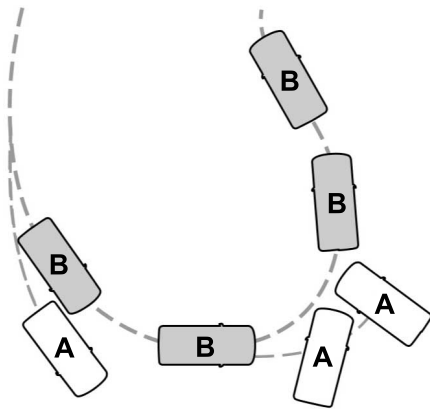

- A Vehicle without stability control skidding off its intended route.

Stability Control

Stability Control and Traction Control with Roll Stability Control

	Stability Control OFF Light	Roll Stability Control³	Electronic Stability Control³	Traction Control System³
Default at start-up	Illuminated during bulb check	Enabled	Enabled ³	Enabled
Button pressed momentarily	Illuminated	Enabled	Enabled ³	Disabled ¹
Button pressed and held for 5 - 15 seconds	Illuminated	Enabled	Disabled ²	Disabled ¹
Button not pressed and transfer case is switched to 4x4 Low or put into Rock Crawl Mode	Illuminated	Disabled	Disabled	Disabled ¹

¹ The Traction Control system can still be enabled but with tighter or looser thresholds.

² When you press and hold the button, a progress bar will display to show the button hold time progress.

³ Functions can vary depending on what selectable drive mode the vehicle is currently in.

STABILITY CONTROL INDICATOR



The system turns on each time you switch the ignition on. You can switch off the traction control portion of the system independently. See **How Does Traction Control Work** (page 229).

Stability Control

STABILITY CONTROL – TROUBLESHOOTING

STABILITY CONTROL – INFORMATION MESSAGES

Service AdvanceTrac	Displayed when the system has detected a condition that requires service. Contact your authorized dealer as soon as possible.
AdvanceTrac Off On	The traction control has been disabled or enabled by the driver

Trail Control - Raptor

WHAT IS TRAIL CONTROL



WARNING: The system does not control speed in low traction conditions or extremely steep slopes. The system is designed to be an aid and does not relieve you of your responsibility to drive with due care and attention. Failure to follow this instruction could result in personal injury.



WARNING: The system does not replace the parking brake. When you leave your vehicle, always apply the parking brake.

Trail control lets you focus on steering during low-speed and off-road use by controlling your vehicle's acceleration and braking to maintain the speed that you set.

You may hear a noise from the anti-lock brake system pump motor when you use the system. This is normal.

TRAIL CONTROL LIMITATIONS

Trail control is unavailable when any of the following occur:

- Your vehicle speed is greater than 20 mph (32 km/h) in two-wheel drive high (2H), four-wheel drive auto (4A) or four-wheel drive high (4H) modes.
- Your vehicle speed is greater than 9 mph (15 km/h) in four-wheel drive low (4L) mode.
- Your vehicle speed is greater than 5 mph (8 km/h) in reverse (R).
- The transmission is in park (P).
- The driver side door is open.
- Cruise control is on.
- The parking brake is applied.

SWITCHING TRAIL CONTROL ON AND OFF



Press the Trail Control on the touchscreen. See **Using the Off-Road Screen** (page 372).

The system switches off if you press the button again or exceed 42 mph (68 km/h).

SETTING THE TRAIL CONTROL SPEED

Note: *The buttons are located on the steering wheel.*

Drive to your preferred speed.



Press the toggle button up to increase the set current speed.



Press the toggle button down to decrease the set current speed.

Note: *The indicator changes color.*

You can adjust the set speed in small or large increments. Press the toggle button up or down once to adjust the set speed in small increments. Press and hold the toggle button up or down to adjust the set speed in large increments.

You can also decrease the set speed by braking.

Note: *If a set speed is set, the trail control is active and the vehicle is stopped by the brake, releasing the brake allows the vehicle to accelerate to the set speed. Pressing the brake pedal does not switch off the system.*

CANCELING THE SET SPEED



Press the button.

Trail Control - Raptor

TRAIL CONTROL INDICATORS



Trail Control - Raptor

TRAIL CONTROL – TROUBLESHOOTING

TRAIL CONTROL – INFORMATION MESSAGES

Message	Details
Reduce Speed To Enter Trail Control	Displays when you must reduce your vehicle speed to use trail control.
Trail Control Not Available with Park Brake Applied	Displays when you must release the park brake to use trail control.
Trail Control Not Available While Pro Trailer Backup Assist™ Active	Displays when you must switch off the trailer backup assist to use trail control.
Trail Control Enabled Use SET Button to Set Speed	Displays when you successfully enabled trail control and can set a speed with the Set+ or Set- control.
Trail Control Off Driver Resume Control	Displays when a system fault has occurred when trail control was active and the driver must resume control.
Trail Control Off	Displays when the system has turned off.
Trail Control Fault See Manual	Displays when a system fault is present. See the trail control section in your Owner's Manual. See your authorized dealer for diagnosis.
Trail Control To Activate Select Gear	Displays when you must be in drive (D), neutral (N) or reverse (R) to use trail control.
Trail Control Not Available with Cruise Control Active	Displays when you must switch the cruise control off to use trail control.
Trail Control Not Available with Driver Door Open	Displays when you must close the driver door to use trail control.
Set Trail Control to 1 MPH to Aid in Getting Unstuck in Sand	Displays when the system detects you may be stuck in sand and recommends using trail control on to the lowest set speed. Doing this could slowly pull sand under the tires to free the vehicle.
Set Trail Control to 2 km/h to Aid in Getting Unstuck in Sand	
Hill Descent Control Now Active Press Trail Control Switch To Exit	Due to some driver action, Trail Control propulsion was turned off but the vehicle will still brake if descending a hill. The driver must press the Trail Control switch to turn the feature OFF, they can then turn it back on.
Trail Control Not Available with Seatbelt Off	Displays when you must have the seatbelt on to use trail control.

Trail Turn Assist

WHAT IS TRAIL TURN ASSIST

Trail turn assist can reduce the turning radius of your vehicle by applying the brakes to the inside rear wheel in low-speed, high steering-angle maneuvers.

TRAIL TURN ASSIST PRECAUTIONS

Note: *Do not use trail turn assist on dry, hard surfaced roads. Doing so can produce excessive noise, increase tire wear and may damage drive line, or braking components. Trail turn assist is only intended for slippery, or loose surfaces.*

You may hear noise from the anti-lock brake system while trail turn assist is active. This is normal operation.

TRAIL TURN ASSIST LIMITATIONS

Trail turn assist can only be used when the vehicle's four-wheel drive system is in the four-wheel drive high (4H), or four-wheel drive low (4L) modes.

Trail Turn Assist cannot be used when the vehicle's rear differential is locked. If the rear differential has recently been locked prior to Trail Turn Assist being turned on, Trail Turn Assist may not activate until it can confirm that the rear differential is unlocked.

SWITCHING TRAIL TURN ASSIST ON AND OFF

You can switch trail turn assist on or off from the touchscreen.

Once trail turn assist activates:

- Vehicle speed is less than 12 mph (19 km/h).
- Vehicle is in four-wheel drive high (4H) or four-wheel drive low (4L).
- Steering wheel is almost fully turned to the left or right.

You can cease trail turn assist by performing any of the following:

- Select two-wheel drive high (2H) or four-wheel drive auto (4A).
- Switch on the rear locking differential.
- Reduce the steering wheel input.

Trail turn assist remains available, even if not active, until you switch it off in the touchscreen.

TRAIL TURN ASSIST INDICATORS



When trail turn assist is on, one of these two indicators will be displayed, depending on the direction of the vehicle's last turn. When the feature is available but not in use, the indicator will be gray. When the feature is active the indicator will be green.

Trail Turn Assist

TRAIL TURN ASSIST – TROUBLESHOOTING

TRAIL TURN ASSIST – INFORMATION MESSAGES

Message	Details
Trail Turn Assist Available in 4L or 4H	Switch to four-wheel drive low (4L) or four-wheel drive high (4H) to activate trail turn assist. See Selecting a Four-Wheel Drive Mode (page 203).
Trail Turn Assist Not Available See Manual	Trail turn assist system malfunction could be present. If this condition persists, have your vehicle serviced.
Trail Turn Assist ON	You have activated trail turn assist.
Trail Turn Assist OFF	You have switched trail turn assist off.

TRAIL TURN ASSIST – FREQUENTLY ASKED QUESTIONS

Why does Trail Turn Assist not activate after unlocking the rear differential?

The rear differential may not be fully disengaged. When possible, turn off the rear axle locker while driving immediately before using trail turn assist. If you are already in a tight turn when you encounter this situation, driving the vehicle for a short distance in reverse could allow the differential to fully disengage.

Steering

ELECTRIC POWER STEERING

HOW DOES ELECTRIC POWER STEERING WORK

The electric power steering system assists the brake system to help operate advanced stability control and accident avoidance systems.

If your vehicle loses electrical power or detects a concern when you are driving, the system switches to reduced steering assist or manual steering. Additionally, whenever disconnecting the battery or installing a new one, you must drive your vehicle a short distance before the system relearns the strategy and reactivates all systems.

ELECTRIC POWER STEERING PRECAUTIONS



WARNING: The electric power steering system has diagnostic checks that continuously monitor the system. If a fault is detected, a message displays in the information display. Stop your vehicle as soon as it is safe to do so. Switch the vehicle off. After at least 10 seconds, switch the vehicle on and watch the information display for a steering system warning message. If a steering system warning message returns, have the system checked as soon as possible.



WARNING: If the system detects an error, you may not feel a difference in the steering, however a serious condition may exist. Have your vehicle checked as soon as possible. Failure to do so may result in loss of steering control.

Adapt your speed and driving behavior according to reduced steering assist.

Extreme continuous steering may increase the effort to steer. This occurs to prevent internal overheating and damage to the steering system. If this occurs, you will not lose the ability to steer your vehicle manually nor will it cause damage to the system. Normal steering and driving allows the system to cool down and steering assist returns to normal.

Note: *There is no fluid reservoir to check or fill.*

STEERING – TROUBLESHOOTING

STEERING – WARNING INDICATORS



The electric power steering system indicator illuminates if the system detects a fault during the continuous diagnostic checks.

Note: *If a red warning message displays, stop your vehicle as soon as it is safe to do so.*

Steering

STEERING – INFORMATION MESSAGES

Message	Action
Steering Fault Service Now	The power steering system has detected a condition that requires service. Have your vehicle checked as soon as possible.
Steering Loss Stop Safely	The power steering system is not working. Stop your vehicle in a safe place. Have your vehicle checked as soon as possible.
Steering Assist Fault Service Required	The power steering system has detected a condition that requires service. Have your vehicle checked as soon as possible.
Steering Lock Malfunction Service Now	The steering system has detected a condition that could prevent you from starting your vehicle. Have your vehicle checked as soon as possible.

Steering

STEERING – FREQUENTLY ASKED QUESTIONS

Why does it seem that the steering is wandering or pulling?

- Check your vehicle for an improperly inflated or uneven tire, loose or worn suspension or steering components, or improper vehicle alignment.

The system is functioning properly and the components have been checked, why is the steering system continuing to pull or wander?

- A high crown in the road or crosswinds could make the steering system feel like it is wandering or pulling.

Parking Aids (If Equipped)

PARKING AID PRECAUTIONS



WARNING: To help avoid personal injury, always use caution when in reverse (R) and when using the sensing system.



WARNING: The system may not detect objects with surfaces that absorb reflection. Always drive with due care and attention. Failure to take care may result in a crash.



WARNING: Traffic control systems, fluorescent lamps, inclement weather, air brakes, external motors and fans may affect the correct operation of the sensing system. This may cause reduced performance or false alerts.



WARNING: The system may not detect small or moving objects, particularly those close to the ground.



WARNING: The parking aid system can only assist you to detect objects when your vehicle is moving at parking speeds. To help avoid personal injury you must take care when using the parking aid system.



WARNING: The system may not function if the sensor is blocked.



WARNING: In cold and severe weather conditions the system may not function. Rain, snow and spray can all limit sensor performance.



WARNING: If damage occurs in the immediate area surrounding the sensor, have your vehicle checked as soon as possible.

Note: If your vehicle sustains damage leaving the sensors misaligned, this will cause inaccurate measurements or false alerts.

When you connect a trailer to your vehicle, the rear parking aid detects the trailer and provides an alert. Disable the parking aid when you connect a trailer to prevent the alert.

Note: The system might detect a connected trailer, if so, it turns parking aid off.

Note: Certain add-on devices installed around the bumper or fascia may create false alerts. For example, large trailer hitches, bike or surfboard racks, license plate brackets, bumper covers or any other device could block the normal detection zone of the parking aid system. Aftermarket spare tires or spare tire covers mounted to the rear tailgate could cause false alerts from the park aid system. Remove the add-on device to prevent false alerts.

Note: Keep the sensors free of debris. Accumulation of dirt, snow or ice over the sensors can affect the accuracy of the system.

Do not clean the sensors with sharp objects.

Note: When using a programmed MyKey, you cannot switch the parking aids off.

SWITCHING PARKING AID ON AND OFF

Using the Parking Aid Button (If Equipped)



Press the parking aid button and use the menu to switch the system on and off.

Parking Aids (If Equipped)

Using the Touchscreen

1. Open the driver assistance menu. See **Center Display** (page 507).
2. Switch Park Aid System on or off.

REAR PARKING AID

WHAT IS THE REAR PARKING AID

Rear parking sensors detect objects behind your vehicle when in reverse (R).

REAR PARKING AID LIMITATIONS

There is a decreased coverage area at the outer corners.

When using a programmed MyKey, you cannot switch the rear parking aid off.

The rear parking aid sensors are active when your vehicle is in reverse (R) and the vehicle speed is less than 5 mph (8 km/h).

The sensor coverage area is up to 71 in (180 cm) from the rear bumper.

The rear parking aid detects large objects when you shift into reverse (R) and any of the following occur:

- Your vehicle is moving backward at a low speed.
- Your vehicle is stationary but an object is approaching the rear of your vehicle at a low speed.
- Your vehicle is moving backward at a low speed and an object is moving towards your vehicle, for example another vehicle at a low speed.

The system shall provide no audible warning for the object behind the vehicle when in neutral (N) gear.

LOCATING THE REAR PARKING AID SENSORS



The rear parking aid sensors are in the rear bumper.

REAR PARKING AID AUDIBLE WARNINGS

A warning tone sounds when your vehicle approaches an object. As your vehicle moves closer to an object, the rate of the tone increases. The warning tone continuously sounds when an object is 12 in (30 cm) or less from the rear bumper.

If your vehicle remains stationary for a few seconds, the audible warning turns off. If your vehicle moves backward the tone sounds again.

Note: When the parking aid system sounds a tone, the audio system could reduce the set volume.

FRONT PARKING AID

WHAT IS THE FRONT PARKING AID

Front parking sensors detect objects in front of your vehicle.

Parking Aids (If Equipped)

FRONT PARKING AID LIMITATIONS

The front parking aid sensors are active when your vehicle is in any position other than park (P) and the vehicle speed is less than 5 mph (8 km/h).

The sensor coverage area is up to 28 in (70 cm) from the front bumper.

If your vehicle is in reverse (R), the front parking aid detects objects and provides an audible warning when your vehicle is moving at a low speed, or when an object is moving toward your vehicle, for example, another vehicle at a low speed. If your vehicle remains stationary for a few seconds, the audible warning turns off. Visual indication is always active in reverse (R).

If your vehicle is in any forward gear, the front parking aid provides audible warnings and a visual indication when your vehicle is moving at a speed of 5 mph (8 km/h) or below and the system detects an object within the detection zone. If your vehicle remains stationary for a few seconds, the visual indication and audible warning turns off.

If your vehicle is in neutral (N), the front and rear sensors provide a visual indication only when your vehicle is moving below a speed of 5 mph (8 km/h) and the system detects obstacles inside the detection areas. Once your vehicle stops, the visual indication and audible warning stops after a few seconds.

LOCATING THE FRONT PARKING AID SENSORS



The front parking aid sensors are in the front bumper.

FRONT PARKING AID AUDIBLE WARNINGS

A warning tone sounds when there is an object within 28 in (70 cm) from the front bumper. As your vehicle moves closer to an object, the rate of the tone increases.

The warning tone continuously sounds when an object is 12 in (30 cm) or less from the front bumper.

Note: *If the detected object is 12 in (30 cm) or less from your vehicle, visual indication remains on.*

SIDE PARKING AID

WHAT IS THE SIDE PARKING AID

The front and rear outermost parking aid sensors map objects that are near to the sides of your vehicle.

SIDE PARKING AID LIMITATIONS

The sensor coverage is up to 24 in (60 cm) from the sides of your vehicle.

Parking Aids (If Equipped)

The side parking aid may not function if:

- Your vehicle remains stationary for over two minutes.
- The anti-lock brake system activates.
- The traction control system activates.
- Your vehicle is in park (P).
- The steering wheel angle information is not available. To reset the steering wheel angle information, drive straight for at least 492 ft (150 m) above 19 mph (30 km/h).

Note: *If you switch traction control off, the side sensing system also turns off.*

To reinitialize the system, drive the length of your vehicle.

The side parking aid does not detect an object that is moving toward the side of your vehicle, for example another vehicle moving at a low speed, if it does not pass a front or rear parking aid sensor.

If the transmission is in reverse (R), the side sensing system provides audible warnings. When your vehicle is moving slowly, the system detects obstacles within 24 in (60 cm) and are inside the driving path of your vehicle. If your vehicle remains stationary for a few seconds, the audible warning turns off. Visual indication is always present in reverse (R).

If your vehicle is in neutral (N), the side sensing system provides visual indication only when your vehicle is moving slowly and there is a front or rear parking aid obstacle detected, and the side obstacle is within 24 in (60 cm) from the side of your vehicle. If your vehicle remains stationary for a few seconds, the visual indication turns off.

If the transmission is in drive (D) or any other forward gear, the side sensing system provides audible and visual warnings. When your vehicle is moving slowly, the system detects obstacles within 24 in (60 cm) and are inside the driving path of your vehicle. If your vehicle remains stationary for a few seconds, the visual indication and audible warning turns off.

LOCATING THE SIDE PARKING AID SENSORS



The side parking sensors are located in the sides of the front and rear bumpers.

SIDE PARKING AID AUDIBLE WARNINGS

When the side parking aid detects an object within the coverage area and the driving path of your vehicle, an audible warning sounds. As your vehicle moves closer to the object, the rate of the tone increases.

Parking Aids (If Equipped)

PARKING AID INDICATORS



The system provides object distance indication through the center display.

- As the distance to the object decreases, the indicator blocks illuminate and move toward the vehicle icon.
- If there is no object detected, the distance indicator blocks are grey.

Visual indication remains on when the transmission is in reverse (R). When you stop your vehicle, visual indication turns off after four seconds.

If the parking aids are not available, the distance indicator blocks do not display.

PARKING AIDS – TROUBLESHOOTING

PARKING AIDS – INFORMATION MESSAGES

If a fault is present in the parking aids, a warning message appears in the instrument cluster or the touchscreen.

Note: *When the front or rear park aid presents a fault message, the side parking aid also disables.*

Message	Action
Check Front Park Aid	The system detects a condition that requires service. Have your vehicle checked as soon as possible.
Check Rear Park Aid	The system detects a condition that requires service. Have your vehicle checked as soon as possible.
Front Park Aid On Off	Displays the park aid status.
Rear Park Aid On Off	Displays the park aid status.

Rear View Camera

WHAT IS THE REAR VIEW CAMERA - VEHICLES WITH: DIGITAL REAR VIEW CAMERA

The rear view camera provides a video image of the area behind your vehicle when the transmission is in reverse (R).



You can access the rear view camera by pressing the button on the touchscreen.

WHAT IS THE REAR VIEW CAMERA - VEHICLES WITH: ANALOG REAR VIEW CAMERA

The rear view camera provides a video image of the area behind your vehicle when the transmission is in reverse (R).

REAR VIEW CAMERA PRECAUTIONS



WARNING: The rear view camera system is a reverse aid supplement device that still requires the driver to use it in conjunction with the interior and exterior mirrors for maximum coverage.



WARNING: Objects that are close to either corner of the bumper or under the bumper, might not be seen on the screen due to the limited coverage of the camera system.



WARNING: Reverse your vehicle slowly. Failure to follow this instruction could result in the loss of control of your vehicle, personal injury or death.



WARNING: Use caution when the tailgate is ajar. If the tailgate is ajar, the camera is out of position and the video image could be incorrect.



WARNING: Use caution when turning camera features on or off when the transmission is not in park (P). Make sure your vehicle is not moving.

Note: When towing, the camera only sees what you are towing. This might not provide adequate coverage and you might not see some objects. In some vehicles, the guide lines may disappear when you connect the trailer tow connector.

LOCATING THE REAR VIEW CAMERA

The rear view camera is on the tailgate. It provides a video image of the area behind your vehicle.

Rear View Camera

REAR VIEW CAMERA GUIDE LINES

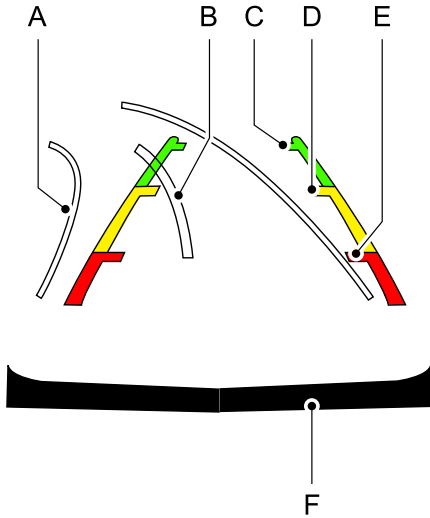

- A Active guide lines.
- B Centerline.
- C Fixed guide line: Green zone.
- D Fixed guide line: Yellow zone.
- E Fixed guide line: Red zone.
- F Rear bumper.

Active guide lines only show with fixed guide lines. To use active guide lines, turn the steering wheel to point the guide lines toward an intended path. If the steering wheel position changes while reversing, your vehicle might deviate from the intended path.

The fixed and active guide lines fade in and out depending on the steering wheel position. The active guide lines do not display when the steering wheel position is straight.

Use caution while reversing. Objects in the red zone are closest to your vehicle and objects in the green zone are farther away. Objects get closer to your vehicle as they move from the green zone to the yellow or red zones. Use the side view mirrors and rear view mirror to get better coverage on both sides and rear of your vehicle.

Note: Active guide lines and fixed guide lines are only available when the transmission is in reverse (R).

Note: The centerline is only available if the active or fixed guide lines are on.

Note: Not all camera modes work properly without an auxiliary camera.

REAR VIEW CAMERA SETTINGS

ZOOMING THE REAR VIEW CAMERA IN AND OUT

**WARNING:** When manual zoom is on, the full area behind your vehicle may not show. Be aware of your surroundings when using the manual zoom feature.

Selectable settings for this feature are zoom in (+) and zoom out (-). Press the symbol on the camera screen to change the view. The default setting is zoom off.

This allows you to get a closer view of an object behind your vehicle. The zoomed image keeps the bumper in the image to provide a reference. The zoom is only active while the transmission is in reverse (R).

Rear View Camera

Note: Manual zoom is only available when the transmission is in reverse (R).

Note: Only the centerline shows when you enable manual zoom.

Note: The rear normal view, hitch view and trailer auxiliary view are also available when your vehicle speed is greater than 6 mph (10 km/h).

SWITCHING REAR VIEW CAMERA DELAY ON AND OFF - VEHICLES WITH: DIGITAL REAR VIEW CAMERA

1. Open the driver assistance menu. See **Center Display** (page 507).
2. Switch **Rear View Camera Delay** on or off.

When shifting the transmission out of reverse (R) and into any gear other than park (P), the camera image remains in the display until the vehicle speed reaches approximately 5 mph (8 km/h) or you shift your vehicle into park (P).

SWITCHING THE REAR VIEW CAMERA VIEW - VEHICLES WITH: DIGITAL REAR VIEW CAMERA



Press to access the different camera views.



Rear normal view provides an image of what is directly behind your vehicle.



Rear split view provides an extended view of what is behind your vehicle.



The hitch view provides an image of the area around the tow hitch.



Trailer AUX camera shows a rear view camera image of what is behind your trailer. This camera view may not be available depending on your vehicle features.

360 Degree Camera (If Equipped)

WHAT IS THE 360 DEGREE CAMERA

The 360 degree camera system provides visibility around your vehicle in parking maneuvers such as:

- Centering in a parking space.
- Obstacles near your vehicle.
- Parallel parking.

The 360 degree camera system consists of front, side and rear cameras.

HOW DOES THE 360 DEGREE CAMERA WORK

The 360 degree camera system:

- Allows you to see what is directly in front of or behind your vehicle.
- Helps you when parallel parking and centering in a parking space.
- Provides a cross traffic view in front of and behind your vehicle.
- Allows you to see a top-down view of the area outside your vehicle, including the blind spots and obstacles near your vehicle.

360 DEGREE CAMERA PRECAUTIONS



WARNING: The 360 degree camera system still requires the driver to use it in conjunction with looking out of the windows, and checking the interior and exterior mirrors for maximum coverage.



WARNING: Objects that are close to either corner of the bumper or under the bumper, might not be seen on the screen due to the limited coverage of the camera system.



WARNING: When manual zoom is on, the full area behind your vehicle may not show. Be aware of your surroundings when using the manual zoom feature.



WARNING: Do not switch the camera features on or off when your vehicle is moving.



WARNING: You are responsible for controlling your vehicle at all times. The system is designed to be an aid and does not relieve you of your responsibility to drive with due care and attention. Failure to follow this instruction could result in the loss of control of your vehicle, personal injury or death.



WARNING: Use caution when the tailgate is ajar. If the tailgate is ajar, the camera is out of position and the video image could be incorrect.

LOCATING THE 360 DEGREE CAMERAS

Rear View Camera

The rear view camera is on the tailgate. It provides a video image of the area behind your vehicle.

Front View Camera

The front view camera is in the front grille. It provides a video image of the area in front of your vehicle.

360 Degree Camera (If Equipped)

Note: For vehicles with selectable drive modes, the front view camera switches on when you are in mud/ruts, deep snow/sand, rock crawl or baja mode, or in four-wheel drive low.

Side View Camera

The side view camera is on the outside mirror. It provides a video image of the area on the sides of your vehicle to aid you when parking or when backing up a trailer.

360 DEGREE CAMERA GUIDE LINES

Note: Active guide lines are only available when the transmission is in reverse (R).

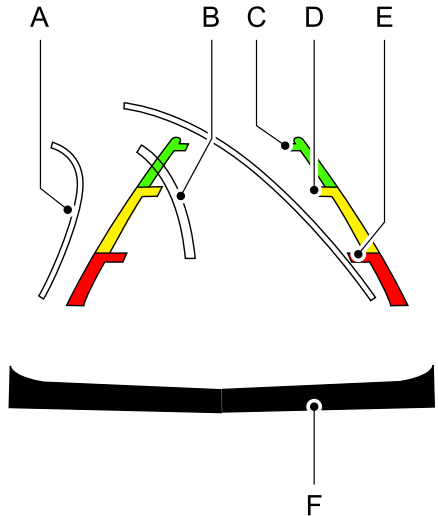

- A Active guide lines.
- B Centerline.
- C Fixed guide line: Green zone.
- D Fixed guide line: Yellow zone.
- E Fixed guide line: Red zone.
- F Rear bumper.

Active guide lines only show with fixed guide lines. Turn the steering wheel to point the guide lines toward an intended path. If the steering wheel position changes when reversing, your vehicle could deviate from the intended path.

The fixed and active guide lines fade in and out depending on the steering wheel position. The active guide lines do not display when the steering wheel position is straight.

360 Degree Camera (If Equipped)

Objects in the red zone are closest to your vehicle and objects in the green zone are farther away. Objects get closer to your vehicle as they move from the green zone to the yellow or red zones. Use the side view mirrors and rear view mirror to get better coverage on both sides and rear of your vehicle.

Keep Out Zone

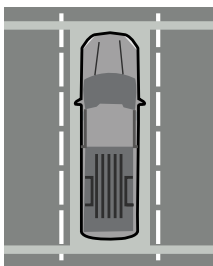

The keep out zone is represented by the yellow dotted lines running parallel to your vehicle.

360 DEGREE CAMERA SETTINGS

SWITCHING THE 360 DEGREE CAMERA ON AND OFF

 To access the 360 degree camera, press the camera button on the touchscreen or shift into reverse (R).

Note: When you press the camera button, it defaults to the front 360 camera view. The other front camera views are accessible on the touchscreen.

Note: The rear view camera activates when you shift into reverse (R). Additional views are then accessible on the touchscreen.

When in park (P), neutral (N) or drive (D), the front images display when you press the camera button.

Note: Not all cameras are available.

Note: The 360 degree camera system turns off when your vehicle is in motion at low speed, except when in reverse (R).

Switching Additional Views On and Off (If Equipped)

You can switch additional camera views on and off via the touchscreen.

Trailer Side View

Trailer side view activates using the turn signal lever with a trailer attached. It provides a side view of the vehicle and trailer for better visibility during lane changes and turns.

To switch trailer side view on and off:

1. Open the driver assistance menu. See **Center Display** (page 507).
2. Switch Trailer Side View on or off.

SWITCHING THE 360 DEGREE CAMERA VIEW

 Press to access the different camera views.

 Front normal view provides an image of what is directly in front of your vehicle.

 Front split view provides an extended view of what is in front of your vehicle.

 Normal + 360 degree view contains the normal camera view next to a 360 degree camera view.

360 Degree Camera (If Equipped)



Rear normal view provides an image of what is directly behind your vehicle.



Rear split view provides an extended view of what is behind your vehicle.



50/50 view provides views of the left and right side of your vehicle. It is available in park (P), neutral (N), and drive (D).



Trailer AUX camera shows a rear view camera image of what is behind your trailer. This camera view may not be available depending on your vehicle features.



The hitch view provides an image of the area around the tow hitch.



Zooms in on the image. See **Connecting a Trailer** (page 331).



Zooms in on the 360 degree image.

Note: *The rear normal view, hitch view, 50/50 view, and trailer aux view are also available when your vehicle speed is greater than 6 mph (10 km/h).*

Active Park Assist (If Equipped)

WHAT IS ACTIVE PARK ASSIST

Assists you with parking in and out of parking spaces.

HOW DOES ACTIVE PARK ASSIST WORK - VEHICLES WITH: FULLY ACTIVE PARK ASSIST

Active park assist uses sensors to detect parking spaces. The system steers, accelerates, brakes and shifts gears as necessary to maneuver into or out of a parking space.

HOW DOES ACTIVE PARK ASSIST WORK - VEHICLES WITH: SEMI ACTIVE PARK ASSIST

Active park assist uses sensors to detect parking spaces. The system controls steering as required to maneuver into or out of a parking space.

ACTIVE PARK ASSIST PRECAUTIONS



WARNING: You must remain in your vehicle when the system turns on. At all times, you are responsible for controlling your vehicle, supervising the system and intervening, if required. Failure to take care may result in the loss of control of your vehicle, serious personal injury or death.



WARNING: The sensors may not detect objects in heavy rain or other conditions that cause interference.



WARNING: You are responsible for controlling your vehicle at all times. The system is designed to be an aid and does not relieve you of your responsibility to drive with due care and attention. Failure to follow this instruction could result in the loss of control of your vehicle, personal injury or death.



WARNING: Do not use the system with accessories that extend beyond the front or rear of your vehicle, for example a trailer hitch or bike rack. The system is not able to make corrections for the additional length of the accessories.

SWITCHING ACTIVE PARK ASSIST ON AND OFF - VEHICLES WITH: FULLY ACTIVE PARK ASSIST



Press the parking aid button, then press the active park assist icon on the touchscreen to bring up full screen notifications.

Press the soft keys on the touchscreen to switch between the parallel park in, perpendicular park in, or parallel park out parking modes.

Cancelling Active Park Assist

To cancel parking assistance at any time, shift out of neutral (N).

Pausing Active Park Assist

To pause parking assistance at any time, release the parking aid button.

Active Park Assist (If Equipped)

If you open the passenger or rear doors, active park assist pauses.

To resume parking, press and hold the parking aid button again.

SWITCHING ACTIVE PARK ASSIST ON AND OFF - VEHICLES WITH: SEMI ACTIVE PARK ASSIST



Press the parking aid button, and then press the active park assist icon on the touchscreen to bring up full screen notifications.

Press the soft keys on the touchscreen to switch between parallel park in, perpendicular park in or parallel park out parking modes.

Cancelling Active Park Assist

To cancel parking assistance at any time:

- Press the active park assist button during operation.
- Grab the steering wheel during operation.
- Drive above 22 mph (35 km/h) for a short period of time when searching for a parking space.
- Drive above 6 mph (9 km/h) during operation.
- Switch traction control off.

ENTERING A PARALLEL PARKING SPACE - VEHICLES WITH: FULLY ACTIVE PARK ASSIST



1. Press the parking button.

Note: The system detects other vehicles and curbs to find a parking space.

2.



Press the active park assist icon on the touchscreen.

3. Use the turn signal lever to search for a parking space on the driver or passenger side of your vehicle.

Note: If you do not use the turn signal lever, the system searches for a parking space on the passenger side of your vehicle.

4. Drive your vehicle approximately 3 ft (1 m) away from and parallel to the other parked vehicles when searching for a parking space.

Note: A tone sounds and a message appears in the information and entertainment display when active park assist finds a suitable parking space.

5. Press and hold the brake pedal.

6. Release the steering wheel and shift into neutral (N).

7.



Press and hold the parking button.

8. Release the brake pedal to allow your vehicle to park.

Note: You can slow down your vehicle at any time by pressing the brake pedal.

Note: When parallel parking between objects, the system parks closer to the object in front of your vehicle to allow easier access to the luggage compartment.

Note: When parking is complete, your vehicle shifts into park (P).

Active Park Assist (If Equipped)

ENTERING A PARALLEL PARKING SPACE - VEHICLES WITH: SEMI ACTIVE PARK ASSIST

1. Press the active park assist button.
2. Select parallel park.

Note: *The system detects other vehicles and curbs to find a parking space.*

3. Use the turn signal lever to search for a parking space on the driver or passenger side of your vehicle.

Note: *The system defaults to searching for a parking spot on the passenger side of your vehicle if you do not use the turn signal lever.*

4. Drive your vehicle approximately 3 ft (1 m) away from and parallel to the other parked vehicles when searching for a parking space.

Note: *A tone sounds and a message appears on the touchscreen when active park assist finds a parking space.*

5. Press and hold the brake pedal.
6. Release the steering wheel and shift into reverse (R).
7. Use the accelerator and brake to control your vehicle's speed when parking. You are responsible for stopping your vehicle.
8. Active park assist is a multi-step process and requires you to shift the transmission multiple times. Follow the onscreen instructions until parking is complete.

Note: *You can slow down your vehicle at any time by pressing the brake pedal.*

Note: *When parallel parking between objects, the system will park closer to the object in front of your vehicle to allow easier access to the cargo area.*

ENTERING A PERPENDICULAR PARKING SPACE - VEHICLES WITH: FULLY ACTIVE PARK ASSIST

1.  Press the parking button.

Note: *Active park assist does not recognize parking space lines and centers your vehicle between objects.*

2.  Press the active park assist icon on the touchscreen.

3. Select perpendicular parking.
4. Use the turn signal lever to search for a parking space on the driver or passenger side of your vehicle.

Note: *If you do not use the turn signal lever, the system searches for a parking space on the passenger side of your vehicle.*

5. Drive your vehicle approximately 3 ft (1 m) away from and perpendicular to the other parked vehicles when searching for a parking space.

Note: *A tone sounds and a message appears in the information and entertainment display when active park assist finds a parking space.*

6. Press and hold the brake pedal.
7. Release the steering wheel and shift into neutral (N).
- 8.

9.  Press and hold the parking button.

9. Release the brake pedal to allow the vehicle to park.

Note: *Active park assist backs your vehicle into parking spaces.*

Active Park Assist (If Equipped)

Note: Active park assist aligns the front end of your vehicle with the lane side of the object next to it.

Note: When the system detects only one object, it allows enough distance to open the door on either side.

Note: You can slow down your vehicle at any time by pressing the brake pedal.

Note: When parking is complete, your vehicle shifts into park (P).

ENTERING A PERPENDICULAR PARKING SPACE - VEHICLES WITH: SEMI ACTIVE PARK ASSIST

1. Press the active park assist button.
2. Select perpendicular parking.

Note: Active park assist does not recognize parking space lines and centers your vehicle between objects.

Note: Active park assist backs your vehicle into parking spaces.

3. Use the turn signal lever to search for a parking space on the driver or passenger side of your vehicle.

Note: The system defaults to searching for a parking spot on the passenger side of your vehicle if you do not use the turn signal lever.

4. Drive your vehicle approximately 3 ft (1 m) away from and perpendicular to the other parked vehicles when searching for a parking space.

Note: A tone sounds and a message appears in the information and entertainment display when active park assist finds a parking space.

5. Press and hold the brake pedal.
6. Release the steering wheel and shift into reverse (R).



7. Use the accelerator and brake to control your vehicle's speed when parking. You are responsible for stopping your vehicle.
8. Active park assist is a multi-step process and requires you to shift the transmission multiple times. Follow the onscreen instructions until parking is complete.

Note: Active park assist aligns the front-end of your vehicle with the lane side of the object next to it.

Note: When only one object is detected, the system allows enough distance to open the door on either side.

Note: You can slow down your vehicle at any time by pressing the brake pedal.

EXITING A PARKING SPACE - VEHICLES WITH: FULLY ACTIVE PARK ASSIST

1.  Press the parking button.
2.  Press the active park assist icon on the touchscreen.
3. Select parallel park exit.
4. Use the turn signal to choose the direction to exit the parking space.
5. Press and hold the brake pedal.
6. Release the parking brake.
7. Release the steering wheel and shift into neutral (N).
8.  Press and hold the parking button.
9. Release the brake pedal to allow your vehicle to move.

Active Park Assist (If Equipped)

Note: After active park assist drives your vehicle to a position where you can exit the parking space in a forward movement, a message appears instructing you to take full control of your vehicle.

10. Take control of your vehicle.

Note: You can slow down your vehicle at any time by pressing the brake pedal.

EXITING A PARKING SPACE - VEHICLES WITH: SEMI ACTIVE PARK ASSIST

Active park assist only assists leaving parallel parking spaces.

1. Press the active park assist button.
2. Select parallel park exit.
3. Use the turn signal to choose the direction to exit the parking space.
4. Press and hold the brake pedal.
5. Release the parking brake.
6. Release the steering wheel and shift into the instructed gear.
7. Use the accelerator and brake to control your vehicle's speed when exiting the parking space. You are responsible for stopping your vehicle.
8. Active park assist is multi-step process and requires you to shift the transmission multiple times. Follow the onscreen instructions until operation is complete.

Note: After active park assist drives your vehicle to a position where you can exit the parking space in a forward movement, a message appears instructing you to take full control of your vehicle.

9. Take control of your vehicle.

Note: You can slow down your vehicle at any time by pressing the brake pedal.

ACTIVE PARK ASSIST – TROUBLESHOOTING

ACTIVE PARK ASSIST – INFORMATION MESSAGES

Message	Details
Active Park Fault	The system requires service. Have your vehicle checked as soon as possible.

ACTIVE PARK ASSIST – FREQUENTLY ASKED QUESTIONS

Why does active park assist not operate correctly?

- The system is unable to detect a vehicle, curb or object to park next to or in between. The system needs boundary objects to operate correctly.

Why does active park assist not search for a parking space?

- You have switched traction control off.
- The transmission is in reverse (R). Your vehicle must be moving forward to be able to detect a parking space.

Why does active park assist not offer a parking space?

- The sensors could be blocked. For example, snow, ice or large accumulations of dirt. Blocked sensors can affect how the system functions.
- The sensors in the front or rear bumper could be damaged.
- There is not enough room in the parking space for your vehicle to safely park.

Active Park Assist (If Equipped)

- There is not enough space for the parking maneuver on the opposite side of the parking space.
- The parking space is more than 1.6 yd (1.5 m) or less than 0.5 yd (0.5 m) away from your vehicle.
- Your vehicle's speed is greater than 21.7 mph (35 km/h) for parallel parking or greater than 11.8 mph (19 km/h) for perpendicular parking.
- You recently disconnected or replaced the battery. After you reconnect the battery you must drive your vehicle on a straight road for a short period of time.

Why does active park assist not correctly position the vehicle into a parking space?

- An irregular curb along the parking space prevents the system from correctly aligning your vehicle.
- Vehicles or objects bordering the space could not be correctly parked.
- Your vehicle stopped too far past the parking space.
- The tires are not correctly installed or maintained. For example, using a spare tire, not inflated correctly, improper size, or of different sizes.
- A repair or alteration changed the detection capabilities.
- A parked vehicle has a high attachment. For example, a salt sprayer, snowplow or moving truck bed.
- The parking space length or position of parked objects changes after your vehicle passes the space.
- The temperature around your vehicle quickly changes. For example, driving from a heated garage into a cold outside temperature, or after leaving a car wash.

Cruise Control

WHAT IS CRUISE CONTROL

Cruise control lets you maintain a set speed without keeping your foot on the accelerator pedal.

Requirements

Use cruise control when the vehicle speed is greater than 20 km/h in metric units or 15 mph in imperial units.

SWITCHING CRUISE CONTROL ON AND OFF



WARNING: Do not use cruise control on winding roads, in heavy traffic or when the road surface is slippery. This could result in loss of vehicle control, serious injury or death.

The cruise controls are on the steering wheel.

Switching Cruise Control On



Press the button to activate the system. When the system activates, the set speed is equal to the current vehicle speed or 20 km/h (15 mph), whichever is greater. If the speed is too low, or other conditions are not correct for cruise control activation, the system enters standby mode.

Switching Cruise Control Off



Press the button when the system is active or switch the ignition off.

Note: When you switch cruise control off, the set speed clears.

SETTING THE CRUISE CONTROL SPEED



WARNING: When you are going downhill, your vehicle speed could increase above the set speed. The system does not apply the brakes.

Drive to the speed you prefer.

SET+

Press the toggle button upward or downward to set the current speed.

SET-

Take your foot off the accelerator pedal.

Note: The indicator changes color in the instrument cluster display.

Changing the Set Speed

SET+

Press and release the toggle button up to increase the set speed in small increments.

Press and hold the toggle button up to accelerate. Release the button when you have reached your preferred speed.

SET-

Press and release the toggle button down to decrease the set speed in small increments.

Press and hold the toggle button down to decelerate. Release the button when you have reached your preferred speed.

Note: If you accelerate by pressing the accelerator pedal, the set speed does not change. When you release the accelerator pedal, your vehicle returns to the speed that you previously set.

Cruise Control

CANCELING THE SET SPEED



Press the button, or tap the brake pedal to cancel the set speed.

Note: *The system remembers the set speed.*

Note: *The system cancels if the vehicle speed drops below 10 mph (16 km/h) under the set speed when driving uphill.*

RESUMING THE SET SPEED



Press the button.

CRUISE CONTROL INDICATORS



Illuminates when you switch the system on.

Adaptive Cruise Control (If Equipped)

HOW DOES ADAPTIVE CRUISE CONTROL WORK

Adaptive cruise control uses a radar sensor to adjust your vehicle speed to maintain a set gap between you and the vehicle in front of you in the same lane.

HOW DOES ADAPTIVE CRUISE CONTROL WITH STOP AND GO WORK

Adaptive cruise control with stop and go uses radar and camera sensors to maintain a set gap between your vehicle and the vehicle in front of you while following it to a complete stop. Stop and go can also be set to follow a vehicle directly in front of you and adjust the set speed, while you are at a complete stop.

ADAPTIVE CRUISE CONTROL PRECAUTIONS



WARNING: You are responsible for controlling your vehicle at all times. The system is designed to be an aid and does not relieve you of your responsibility to drive with due care and attention. Failure to follow this instruction could result in the loss of control of your vehicle, personal injury or death.



WARNING: Pay close attention to changing road conditions such as entering or leaving a highway, on roads with intersections or roundabouts, roads without visible lanes of travel, roads that are winding, slippery, unpaved, or steep slopes.



WARNING: The system does not control speed in low traction conditions or extremely steep slopes. The system is designed to be an aid and does not relieve you of your responsibility to drive with due care and attention. Failure to follow this instruction could result in personal injury.



WARNING: The system is not a crash warning or avoidance system.



WARNING: Do not use the system when towing a trailer that has aftermarket electronic trailer brake controls. Failure to follow this instruction could result in the loss of control of your vehicle, personal injury or death.



WARNING: Do not use tire sizes other than those recommended because this can affect the normal operation of the system. Failure to do so may result in a loss of vehicle control, which could result in serious injury.



WARNING: Do not use the system with a snow plow blade installed.



WARNING: Do not use the system in poor visibility, for example fog, heavy rain, spray or snow.

When Following a Vehicle



WARNING: When following a vehicle that is braking, your vehicle does not always decelerate quickly enough to avoid a crash without driver intervention. Apply the brakes when necessary. Failure to follow this instruction could result in personal injury or death.

Adaptive Cruise Control (If Equipped)

Hilly Condition Usage

You should select a lower gear when the system is active in situations such as prolonged downhill driving on steep slopes, for example in mountainous areas. The system needs additional engine braking in these situations to reduce the load on the vehicle's regular brake system to prevent it from overheating.

Note: *An audible alarm sounds and the system shuts down if it applies brakes for an extended period of time. This allows the brakes to cool. The system functions normally again after the brakes cool.*

ADAPTIVE CRUISE CONTROL LIMITATIONS

Sensor Limitations

 **WARNING:** On rare occasions, detection issues can occur due to the road infrastructures, for example bridges, tunnels and safety barriers. In these cases, the system may brake late or unexpectedly. At all times, you are responsible for controlling your vehicle, supervising the system and intervening, if required.

 **WARNING:** If the system malfunctions, have your vehicle checked as soon as possible.

 **WARNING:** Large contrasts in outside lighting can limit sensor performance.

 **WARNING:** The system only warns of vehicles detected by the radar sensor. In some cases there may be no warning or a delayed warning. Apply the brakes when necessary. Failure to follow this instruction could result in personal injury or death.

 **WARNING:** The system may not detect stationary or slow moving vehicles below 6 mph (10 km/h).

 **WARNING:** The system does not detect pedestrians or objects in the road.

 **WARNING:** The system does not detect oncoming vehicles in the same lane.

 **WARNING:** The system may not operate properly if the sensor is blocked. Keep the windshield free from obstruction.

 **WARNING:** The sensor may incorrectly track lane markings as other structures or objects. This can result in a false or missed warning.

Adaptive Cruise Control (If Equipped)

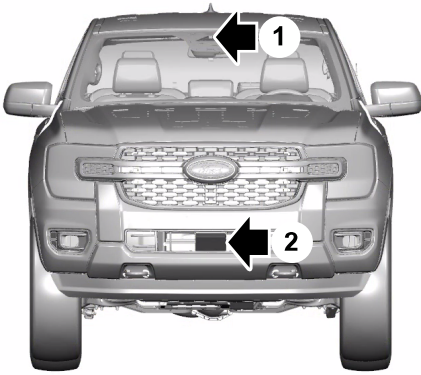

1. Camera.
2. Radar sensor.

The camera is mounted on the windshield behind the interior mirror.

The radar sensor is in the lower grille.

Note: You cannot see the sensor. It is behind a fascia panel.

Note: Keep the front of your vehicle free of dirt, metal badges or objects. Vehicle front protectors, aftermarket lights, additional paint or plastic coatings could also degrade sensor performance.

A message displays if something obstructs the camera or the sensor. When something blocks the sensor, the system cannot detect a vehicle ahead and does not function. See **Adaptive Cruise Control – Information Messages** (page 276).

The radar sensor has a limited field of view. It may not detect vehicles at all or detect a vehicle later than expected in some situations. The lead vehicle image does not illuminate if the system does not detect a vehicle in front of you.

Detection issues can occur:

A

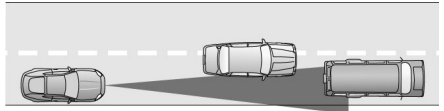

B



C

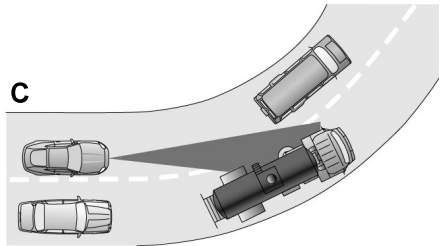

- A When driving on a different line than the vehicle in front.
- B With vehicles that edge into your lane. The system can only detect these vehicles once they move fully into your lane.
- C There may be issues with the detection of vehicles in front when driving into and coming out of a bend or curve in the road.

In these cases, the system may brake late or unexpectedly.

If something hits the front end of your vehicle or damage occurs, the radar-sensing zone may change. This could cause missed or false vehicle detection.

Adaptive Cruise Control (If Equipped)

Optimal system performance requires a clear view of the road by the windshield-mounted camera.

Optimal performance may not occur if:

- The camera is blocked.
- There is poor visibility or lighting conditions.
- There are bad weather conditions.

SWITCHING ADAPTIVE CRUISE CONTROL ON AND OFF

The cruise controls are on the steering wheel. See **Cruise Control** (page 261).

Switching Adaptive Cruise Control On



Press the button to activate the system. When the system activates, the set speed is equal to the current vehicle speed. If the speed is too low, or other conditions are not correct for adaptive cruise control activation, the system enters standby mode.

Note: *The minimum set speed is 15 mph or 20 km/h.*

The indicator, current gap setting and set speed appear in the instrument cluster display.

Switching Adaptive Cruise Control Off



Press the button when the system is in standby mode or switch the ignition off.

Note: *When you switch the system off, the set speed clears.*

Automatic Cancellation or Deactivation

The system may cancel if:

- The tires lose traction.
- You apply the parking brake.
- Your vehicle speed falls significantly below 15 mph or 20 km/h.

The system may turn off or prevent activating when requested if:

- The vehicle has a blocked sensor.
- The brake temperature is too high.
- There is a failure in the system or a related system.

ADAPTIVE CRUISE CONTROL AUTOMATIC CANCELLATION

The system may cancel if:

- The tires lose traction.
- You apply the parking brake.

The system may cancel and set the parking brake if:

- You unbuckle the seatbelt and open the driver door after adaptive cruise control stops your vehicle.
- Adaptive cruise control holds your vehicle at a stop continuously for more than three minutes.

The system may deactivate or prevent activating when requested if:

- The vehicle has a blocked sensor.
- The brake temperature is too high.
- There is a failure in the system or a related system.

SETTING THE ADAPTIVE CRUISE CONTROL SPEED

Drive to the speed you prefer.

Adaptive Cruise Control (If Equipped)

SET+

Press the toggle button up or down to set the current speed.

SET-

Take your foot off the accelerator pedal.

The indicator, current gap setting and set speed appear in the instrument cluster display.

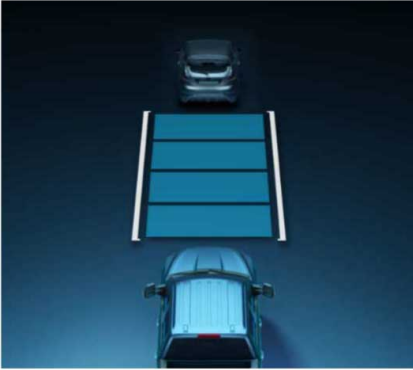

A vehicle image illuminates if there is a vehicle detected in front of you.

Note: When adaptive cruise control is active, the speedometer may vary slightly from the set speed displayed in the instrument cluster display.

Setting the Adaptive Cruise Speed from a Complete Stop

SET+

Press the toggle button up or down while keeping the brake pedal fully pressed.

SET-

The set speed adjusts to 15 mph when in imperial units or 20 km/h when in metric units.

The indicator, current gap setting and set speed appear in the instrument cluster display.

Note: The system activates from a complete stop only when it detects a lead vehicle in close proximity.

Manually Changing the Set Speed

SET+

Press and release the toggle button up to increase the set speed in small increments. Press and hold the toggle button up to increase the set speed in large increments. Release the button when the set speed is equal to the preferred speed.

SET-

Press and release the toggle button down to decrease the set speed in small increments. Press and hold the toggle button down to decrease the set speed in large increments. Release the button when the set speed is equal to the preferred speed.

You can also press the accelerator or brake pedal until you reach the speed you prefer. Press the toggle button up or down to select the current speed as the set speed.

The system may apply the brakes to slow the vehicle to the new set speed. The set speed continuously displays in the instrument cluster display when the system is active.

SETTING THE ADAPTIVE CRUISE CONTROL GAP



Press the button to cycle through the four gap settings.

Adaptive Cruise Control (If Equipped)



The selected gap appears in the instrument cluster display as shown by the bars in the image.

Note: The gap setting is time dependent and therefore, the distance adjusts with your vehicle speed.

Note: It is your responsibility to select a gap appropriate to the driving conditions.

Adaptive Cruise Control Gap Settings

Graphic Display, Bars Indicated Between Vehicles	Gap Distance	Dynamic Behavior
1	Closest.	Sport.
2	Close.	Normal.
3	Medium.	Normal.
4	Far.	Comfort.

Each time you switch the system on, it selects the last chosen gap setting.

Following a Vehicle

When a vehicle ahead of you enters the same lane or a slower vehicle is ahead in the same lane, the vehicle speed adjusts to maintain the gap setting.

Note: When you are following a vehicle and you switch on a turn signal lamp, adaptive cruise control may provide a small, temporary acceleration to help you pass.

Your vehicle maintains a consistent gap from the vehicle ahead until:

- The vehicle in front of you accelerates to a speed above the set speed.
- The vehicle in front of you moves out of the lane you are in.
- You set a new gap distance.

The system applies the brakes to slow down your vehicle to maintain a safe gap distance from the vehicle in front of you. The system only applies limited braking. You can override the system by applying the brakes.

Note: The brakes may emit noise when applied by the system.

If the system determines that its maximum braking level is not sufficient, an audible warning sounds, a message appears in the instrument cluster display and an indicator flashes when the system continues to brake. Take immediate action.

CANCELING THE SET SPEED



Press the button or tap the brake pedal.

The set speed does not erase.

RESUMING THE SET SPEED



Press the button.

Adaptive Cruise Control (If Equipped)

Your vehicle speed returns to the previously set speed and gap setting. The set speed displays continuously in the instrument cluster display when the system is active.

Note: Only use resume if you are aware of the set speed and intend to return to it.

Resuming the Set Speed from a Complete Stop (If Equipped)

If your vehicle follows a vehicle to a complete stop and remains stationary for less than a few seconds, your vehicle accelerates from a stationary position to follow the vehicle ahead.

If your vehicle follows a vehicle to a complete stop and remains stationary for more than a few seconds, an indicator and message displays.



Message	Action
Stopped	Cruise control does not resume automatically when this display is active.
Press button to resume	If the lead vehicle begins to move, you are prompted to press the resume button. Press and release the button or use the accelerator pedal to resume following the lead vehicle.
Auto-Resume	Displays when on a limited access highway after following a vehicle to a complete stop. In this situation, the vehicle resumes following the lead vehicle without a button press or pressing the accelerator pedal. The system can remain in auto-resume state for approximately 30 seconds, after which it no longer automatically resumes.

Adaptive Cruise Control (If Equipped)

OVERRIDING THE SET SPEED



WARNING: If you override the system by pressing the accelerator pedal, it does not automatically apply the brakes to maintain a gap from any vehicle ahead.

When you press the accelerator pedal, you override the set speed and gap distance.

Use the accelerator pedal to intentionally exceed the set speed limit.

When you override the system, the green indicator illuminates and the vehicle icon does not appear in the instrument cluster display.

The system resumes operation when you release the accelerator pedal. The vehicle speed decreases to the set speed, or a lower speed if following a slower vehicle.

ADAPTIVE CRUISE CONTROL INDICATORS



Illuminates when you switch adaptive cruise control on. The color of the indicator changes to indicate the system status.

White indicates the system is on but inactive.

Green indicates that you set the speed and the system is active.

SWITCHING FROM ADAPTIVE CRUISE CONTROL TO CRUISE CONTROL



WARNING: Normal cruise control will not brake when your vehicle is approaching slower vehicles. Always be aware of which mode you have selected and apply the brakes when necessary.

1.  Press the button on the touchscreen.
2. Press **Driver Assistance**.
3. Press **Cruise Control**.
4. Press **Normal Cruise Control**.



The cruise control indicator replaces the adaptive cruise control indicator if you select normal cruise control. The gap setting does not display, and the system does not respond to lead vehicles. Automatic emergency braking remains active to maintain set speed. The system remembers the last setting when you start your vehicle.

LANE CENTERING

HOW DOES LANE CENTERING WORK

Adaptive cruise control with lane centering uses the vehicle's front radar sensor and front windshield camera sensor, together with the steering sensor to operate.

Using these sensors, the system applies continuous steering assistance towards driving in the middle of the lane you choose on highway roads.

Adaptive Cruise Control (If Equipped)

Note: The gap setting for adaptive cruise control with lane centering, operates in the same way as normal adaptive cruise control.

LANE CENTERING PRECAUTIONS



WARNING: Do not use the system when towing a trailer. Failure to follow this instruction could result in the loss of control of your vehicle, personal injury or death.



WARNING: Do not use the system if any changes or modifications to the steering wheel have been made. Any changes or modifications to the steering wheel could affect the functionality or performance of the system. Failure to follow this instruction could result in the loss of control of your vehicle, personal injury or death.

Adaptive cruise control precautions apply to lane centering unless stated otherwise or contradicted by a lane centering precaution. See **Adaptive Cruise Control Precautions** (page 263).

LANE CENTERING REQUIREMENTS

You must keep your hands on the steering wheel at all times.

Lane centering only activates when all of the following occur:

- Adaptive cruise control with lane centering is enabled in your information and entertainment screen. See **Switching Lane Centering On and Off** (page 272).
- You have adaptive cruise control with stop and go enabled and set.
- The steering sensor detects your hands on the steering wheel.

- The system detects both lane markings when driving on a straight road.
- Your vehicle is initially centered in the lane between two visible line markings.

Note: If the system does not detect valid lane line markings, the system will remain in standby until valid line markings are available.

LANE CENTERING LIMITATIONS

Adaptive cruise control limitations apply to lane centering unless stated otherwise or contradicted by a lane centering limitation. See **Adaptive Cruise Control Limitations** (page 264).

Lane centering may not correctly operate in any of the following conditions:

- The lane width is too narrow or wide.
- The curve in the road is too tight.
- The system does not detect the minimum required lane markings or when lanes merge or split.
- When the required steering effort to maintain lane center exceeds the lane centering system limit.
- When driving in areas that are under construction or when road work is in progress.
- If the front windshield camera and/or the front radar are blocked.
- When using a spare tire.
- Inclement weather conditions including, but not limited to, high wind, heavy rain, and fog.
- Driving into direct sunlight.
- When modification to the steering system has been made, including alterations to the steering wheel.
- When towing a trailer.

See **Lane Centering Precautions** (page 271).

Adaptive Cruise Control (If Equipped)

Note: The system steering assistance is limited and may not have sufficient effort for all driving situations and/or conditions, such as driving through tight curves or driving through curves at high speeds.

Note: In exceptional conditions, the system may deviate from the lane center.

SWITCHING LANE CENTERING ON AND OFF

You must keep your hands on the steering wheel at all times.

The controls are on the steering wheel.



Press the button.

The indicator appears in the instrument cluster. When the lane centering system is on, the color of the indicator changes to indicate the system status.

You can override the system at any time by steering your vehicle.

Note: The lane centering requirements must be met before you can enable the feature. See **Lane Centering Requirements** (page 271).

Enabling and Disabling Lane Centering

- Press the button on the touchscreen.
- Press **Driver Assistance**.
- Press **Cruise Control**.
- Press **Adaptive Cruise Control**.
- Switch Lane Centering on or off.

LANE CENTERING ALERTS

You must keep your hands on the steering wheel at all times.

When the system is active and detects no steering activity for a period of time, the system alerts you to put your hands on the steering wheel. If you do not react appropriately to the warnings the adaptive cruise control with lane centering system cancels and slows your vehicle down to idle speeds while maintaining steering control. See **Lane Centering Automatic Cancellation** (page 272).

The system also alerts you if your vehicle crosses lane line markings without detected steering activity.

Note: The system could detect a light grip or light touch on the steering wheel as hands-off driving.

LANE CENTERING AUTOMATIC CANCELLATION

When an external condition cancels the system, and your hands are on the steering wheel, a tone sounds and a message appears in the instrument cluster display.

When an external condition cancels the system, and your hands are not on the steering wheel, the system immediately alerts you to take control of the vehicle. If this alert is ignored, the system slows the vehicle while maintaining steering assistance when lane markings are available. When no lane markings are available, the vehicle comes to a stop.



If your vehicle starts to slow down after system cancellation, you must take full control of the vehicle. To re-enable adaptive cruise control with lane centering after cancellation, press and release the resume button.

Automatic cancellation can also occur if:

- The lane becomes too wide or narrow.
- The system cannot detect valid lane markings.

Adaptive Cruise Control (If Equipped)

- Lane markings cross over one another.
- The curve of the road is too sharp.

Note: *If your vehicle slows down due to your inactivity twice within a key cycle, the system disables. To reset the system, when the vehicle is stationary, return the gear selector to park (P) and turn the vehicle off. Then, restart the vehicle with your foot on the brake pedal.*

LANE CENTERING MANUAL CANCELLATION

When you perform the following actions, adaptive cruise control with lane centering will cancel:

- The brake pedal is pressed.
- Adaptive cruise control button on the steering wheel is switched off.

The lane centering system is momentarily suppressed when either of the following actions are performed:

- Turn signal indicator is latched or tapped.
- You steer the vehicle out of lane.

LANE CENTERING INDICATORS



Illuminates when you switch lane centering on. The color of the indicator changes to indicate the system status.

Gray status indicates the system is on but in standby mode.

Green status indicates the system is enabled and applying steering assistance to keep the vehicle in the center of the lane.

Amber status with an audible tone, that then changes to gray status, indicates a system automatic cancellation.

LANE CENTERING – TROUBLESHOOTING

LANE CENTERING – INFORMATION MESSAGES

Note: *Depending on your vehicle options and instrument cluster type, not all messages display or are available.*

Adaptive Cruise Control (If Equipped)

Message	Action
Keep Hands on Steering Wheel	You must return your hands to the steering wheel and provide steering input to cancel the message.
Lane Centering Assist Not Available	Lane centering is currently not available, due to conditions that prevent the system from becoming active. To reset the system, when the vehicle is stationary, return the gear selector to park (P) and turn the vehicle off. Then, restart the vehicle with your foot on the brake pedal.
Resume Control	Adaptive cruise control with lane centering is about to cancel. You must immediately take full control of the vehicle.
Press Accelerator Pedal to Resume	Adaptive cruise control with lane centering is in standby mode. When safe to do so, you can resume adaptive cruise control with lane centering by applying pressure on the accelerator pedal. Alternatively, you can also re-enable adaptive cruise control with lane centering by pressing the resume button on the steering wheel.

Note: *The adaptive cruise control gap setting operates normally when the feature is enabled.*

INTELLIGENT ADAPTIVE CRUISE CONTROL

HOW DOES INTELLIGENT ADAPTIVE CRUISE CONTROL WORK

Intelligent adaptive cruise control combines speed sign recognition and navigation map data with adaptive cruise control to adjust the cruise set speed to the speed limit detected by the speed sign recognition system. As the system detects new speed signs, the set speed updates.

There are limitations that affect the accuracy of the speed sign recognition system and its ability to determine the current speed limit. The intelligent adaptive cruise control system and its ability to determine the current speed limit shares these limitations. See **Speed Sign Recognition** (page 318).

INTELLIGENT ADAPTIVE CRUISE CONTROL PRECAUTIONS



WARNING: You are responsible for controlling your vehicle at all times. The system is designed to be an aid and does not relieve you of your responsibility to drive with due care and attention. Failure to follow this instruction could result in the loss of control of your vehicle, personal injury or death.

INTELLIGENT ADAPTIVE CRUISE CONTROL LIMITATIONS

The speed limit information provided by the navigation map data could be inaccurate or out of date.

Adaptive Cruise Control (If Equipped)

The system may not detect and read speed limit signs with conditional information, for example, when a sign is flashing, during specific time ranges, or when children are present.

Note: *The system does not set the vehicle speed to speed limits shown with a supplementary traffic sign.*

Under certain conditions, the system may not adjust the vehicle speed until after your vehicle passes the speed limit.

SWITCHING INTELLIGENT MODE ON AND OFF

1.  Press the button on the touchscreen.
2. Press **Driver Assistance**.
3. Press **Cruise Control**.
4. Press **Adaptive Cruise Control**.
5. Press **Speed Sign Recognition**.

ADJUSTING THE SET SPEED TOLERANCE

1.  Press the button on the touchscreen.
2. Press **Driver Assistance**.
3. Press **Cruise Control**.
4. Press **Adaptive Cruise Control**.
5. Press **Speed Sign Recognition**.
6. Press **Tolerance**.
7. Use the slider bar to adjust the allowable tolerance for the system.

Note: *You cannot set the tolerance more than 20 mph (30 km/h) above or below the recognized speed.*

INTELLIGENT ADAPTIVE CRUISE CONTROL ALERTS

If you increase the set speed beyond the speed limit or speed limit plus a positive tolerance value, the set speed indicator flashes.

The warning does not occur if:

- You override the set speed using the accelerator pedal.
- The vehicle speed exceeds the set speed due to being on a downhill slope.

INTELLIGENT ADAPTIVE CRUISE CONTROL INDICATORS



The set speed limit displays next to the detected speed limit in the instrument cluster.

INTELLIGENT ADAPTIVE CRUISE CONTROL – TROUBLESHOOTING

INTELLIGENT ADAPTIVE CRUISE CONTROL – INFORMATION MESSAGES

Note: *Depending on your vehicle options and instrument cluster type, not all messages display or are available.*

Adaptive Cruise Control (If Equipped)

Note: Certain messages may be abbreviated or shortened depending upon which cluster type you have.

Message	Details
Intelligent Cruise Control Speed Sign Recognition Not Available	Conditions exist preventing the system from being available. Check that the front windshield camera is not blocked. Navigation system information may not be available. If the message continues to appear, have your vehicle checked as soon as possible.

Note: The system could abbreviate or shorten certain messages depending upon which cluster type you have.

ADAPTIVE CRUISE CONTROL – TROUBLESHOOTING

ADAPTIVE CRUISE CONTROL – INFORMATION MESSAGES - VEHICLES WITH: STOP AND GO

Note: Depending on your vehicle options and instrument cluster type, not all messages display or are available.

Message	Action
Adaptive Cruise Malfunction	A malfunction is preventing the adaptive cruise from engaging.
Front Sensor Not Aligned	Contact an authorized dealer to have the radar checked for proper coverage and operation.
Adaptive Cruise Not Available	Conditions exist preventing the system from being available.
Adaptive Cruise Not Available Sensor Blocked See Manual	You have a blocked radar because of poor radar visibility due to inclement weather or ice, mud, or water in front of the radar. You can typically clean the sensor to resolve this. Due to the nature of radar technology, it is possible to get a blockage warning with no actual block. This happens, for example, when driving in sparse rural or desert environments. A false blocked condition either self clears, or clears after you restart your vehicle.

Adaptive Cruise Control (If Equipped)

Message	Action
Normal Cruise Active Adaptive Braking Off	You have selected normal cruise control. The system does not brake or react to traffic.
Adaptive Cruise - Driver Resume Control	Displays when the adaptive cruise control is going to cancel and you must take control.
Adaptive Cruise Speed Too Low to Activate	Displays when the vehicle speed is too slow to activate the adaptive cruise control and there is no lead vehicle in range.

Drive Mode Control - Excluding: Raptor

WHAT IS DRIVE MODE CONTROL

Your vehicle has various drive modes that you can select for different driving conditions. Depending on the drive mode that you select, the system adjusts various vehicle settings.

HOW DOES DRIVE MODE CONTROL WORK

Drive mode control adjusts your vehicle configuration for each mode you select.

Changing the drive mode adjusts the steering effort and feel of the steering system.

The stability and traction control assist your vehicle control in adverse conditions or high-performance driving.

Throttle control enhances the powertrain response, transmission controls become optimized with shift schedules, and four-wheel drive settings are optimized and tuned to each mode.

Changing the drive mode can engage or disengage the electronic locking differentials.

Changing the drive mode changes the four-wheel drive mode to the default setting for the selected drive mode.

Note: The system has diagnostic checks that continuously monitor the system for proper operation. If a mode is unavailable due to a system fault, the drive mode system defaults to normal. When the system defaults to normal, the driveline settings remain the same as prior to the system fault.

Note: Your vehicle reverts to normal mode each time it is started. If you shut your vehicle off in a drive mode other than normal mode, at startup the instrument cluster screen displays a pop-up asking if you would like to return to your last used drive mode. If you select yes to the pop-up, your vehicle returns to the last selected drive mode and the default four-wheel driveline setting associated with that drive mode. If you select no, your vehicle remains in normal mode and the default four-wheel driveline setting associated with that drive mode. If you do not select yes or no the pop up message times out, your vehicle remains in normal mode, and the four-wheel driveline setting remains in its last used setting.

SELECTING A DRIVE MODE



Press the button on the center console. The first press activates the drive mode selection menu in the display. Subsequent presses change the selected drive mode.

Note: Button icons vary depending on the vehicle.

Note: Mode changes are not available when your vehicle is off or when the transmission is in reverse (R).

Drive Mode Control - Excluding: Raptor

SELECTING A DRIVE MODE (IF EQUIPPED)

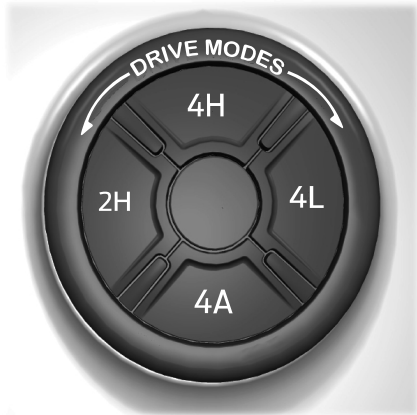

Rotate the drive mode control on the center console to select or change a drive mode.

Note: Button icons vary depending on the vehicle.

DRIVE MODES

ECO



For efficient driving. This mode helps deliver maximum fuel efficiency and helps to increase driving range.

Depending on your vehicle options, four-wheel drive auto (4A) or two-wheel drive high (2H) is the default four-wheel drive mode. Four-wheel drive low (4L) is not selectable in eco mode.

The rear electronic locking differential is available below 25 mph (40 km/h).

MUD/RUTS - FX4+



For off-road driving. This mode enhances vehicle performance to traverse muddy, rutted or uneven terrains.

Four-wheel drive high (4H) is the default four-wheel drive mode. Four-wheel drive low (4L) is selectable in mud/ruts mode. Depending on your vehicle options, four-wheel drive auto (4A) or two-wheel drive high (2H) is not selectable in mud/ruts mode.

The rear electronic locking differential is engaged when in mud/ruts mode and is available at any speed in all selectable four-wheel drive modes.

Note: Do not use this mode on dry, hard pavement. This could produce some vibration, driveline bind up, and potential excessive tire and vehicle wear depending on the four-wheel drive mode selection.

NORMAL



For everyday driving. This mode is the perfect balance of excitement, comfort and convenience. This is the default mode after each ignition cycle, the driveline settings remain the same prior to the ignition cycle.

Depending on your vehicle options, four-wheel drive auto (4A) or two-wheel drive high (2H) is the default four-wheel drive mode. All four-wheel drive modes are selectable when in normal mode.

The rear electronic locking differential is available below 25 mph (40 km/h).

Note: The rear electronic locking differential is available at any speed when in four-wheel drive low (4L).

Drive Mode Control - Excluding: Raptor

SAND



For off-road driving on soft, dry sand or deep snow. This mode may help get your vehicle unstuck from deep snow or sand.

Four-wheel drive high (4H) is the default four-wheel drive mode. Four-wheel drive low (4L) is selectable in sand mode. Depending on your vehicle options, four-wheel drive auto (4A) or two-wheel drive high (2H) is not selectable in sand mode.

The rear electronic locking differential is engaged when in sand mode and is available at any speed in all selectable four-wheel drive modes.

Note: *Do not use this mode on dry, hard pavement. This could produce some vibration, driveline bind up, and potential excessive tire and vehicle wear depending on the four-wheel drive mode selection.*

Note: *Sand mode is not intended for use on firm, slippery surfaces, such as paved roads covered with snow or ice. For slippery, firm surfaces use slippery mode.*

SLIPPERY



For less than ideal conditions such as snow or ice. This mode can be used for crossing terrain where a firm surface is covered with loose or slippery material. Slippery mode lowers throttle response and optimizes shifting for slippery surfaces.

Depending on your vehicle options, four-wheel drive auto (4A) or four-wheel drive high (4H) is the default four-wheel drive mode. When Four-wheel drive auto (4A) is the default, two-wheel drive high (2H) is not available.

The rear electronic locking differential is available below 25 mph (40 km/h).

Note: *The rear electronic locking differential is available at any speed when in four-wheel drive low (4L).*

Note: *Do not use this mode on hard pavement while in four-wheel drive high (4H) or four-wheel drive low (4L). This could produce some vibration, driveline bind up, and potential excessive tire and vehicle wear depending on the four-wheel drive mode selection.*

TOW/HAUL



For improved transmission operation when towing a trailer or a heavy load. This mode moves upshifts to higher engine speeds to reduce the frequency of transmission shifting. This mode also provides engine braking in all forward gears, which slows your vehicle and assists you in controlling your vehicle when descending a slope. The amount of downshift braking provided varies based on the amount you press the brake pedal.

Four-wheel drive auto (4A) is the default four-wheel drive mode when four-wheel drive auto (4A) is available, otherwise this mode does not default to a certain four-wheel drive mode and maintains the previous selection. All four-wheel drive modes are selectable when in tow/haul.

The system tunes the steering to enhance driving comfort when towing or carrying heavy loads.

The rear electronic locking differential is available below 25 mph (40 km/h).

Note: *The rear electronic locking differential is available at any speed when in four-wheel drive low (4L).*

Drive Mode Control - Excluding: Raptor

TRAIL - VEHICLES WITH: FX2 PACKAGE



Trail mode is for off-road driving on muddy, rutted, soft or uneven terrain. This mode lowers throttle response to increase wheel spin to keep the tires clear and to prevent getting stuck.

The electronic locking differential is available below 25 mph (40 km/h). See **Switching the Electronic Locking Differential On and Off** (page 209).

Drive Mode Control - Raptor

WHAT IS DRIVE MODE CONTROL

Your vehicle has various drive modes that you can select for different driving conditions. Depending on the drive mode that you select, the system adjusts various vehicle settings.

HOW DOES DRIVE MODE CONTROL WORK

Drive mode control adjusts your vehicle configuration for each mode you select.

Changing the drive mode adjusts the steering effort and feel of the steering system.

The stability and traction control assist your vehicle control in adverse conditions or high-performance driving.

Throttle control enhances the powertrain response, transmission controls become optimized with shift schedules, and four-wheel drive settings are optimized and tuned to each mode.

Changing the drive mode can engage or disengage the electronic locking differentials.

Changing the drive mode changes the four-wheel drive mode to the default setting for the selected drive mode.

Note: The system has diagnostic checks that continuously monitor the system for proper operation. If a mode is unavailable due to a system fault, the drive mode system defaults to normal. When the system defaults to normal, the driveline settings remain the same as prior to the system fault.

Note: Your vehicle reverts to normal mode each time it is started. If you shut your vehicle off in a drive mode other than normal mode, at startup the instrument cluster screen displays a pop-up asking if you would like to return to your last used drive mode. If you select yes to the pop-up, your vehicle returns to the last selected drive mode and the default four-wheel driveline setting associated with that drive mode. If you select no, your vehicle remains in normal mode and the default four-wheel driveline setting associated with that drive mode. If you do not select yes or no the pop up message times out, your vehicle remains in normal mode, and the four-wheel driveline setting remains in its last used setting.

SELECTING A DRIVE MODE

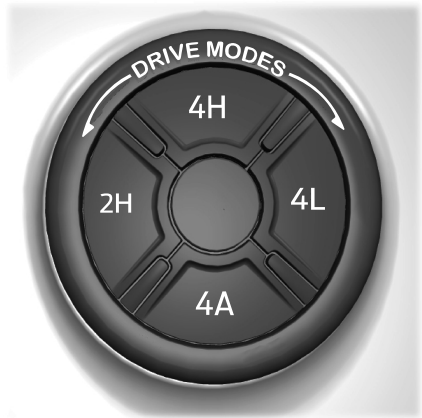

Rotate the drive mode control on the center console to select or change a drive mode.

Note: Button icons vary depending on the vehicle.

Drive Mode Control - Raptor

Selecting a Steering Mode



To change the steering feel, press the button on the steering wheel. The first press displays a pop-up message in the instrument cluster display of the selected mode and subsequent presses changes the selected mode.

Modes:

- Normal – Developed to complement vehicle response during daily driving.
- Sport – Slightly less assist and damping for improved steering feel during spirited driving.
- Comfort – Slightly more assist for driver preference and daily driving ease.
- Off-road – Similar assist to Normal with added damping for improved control during off-road driving.

After selecting the desired setting, you may feel a soft feedback bump in the steering wheel when the changeover occurs.

Note: *If you disconnect or remove the battery, the steering system defaults to normal.*

Selecting a Suspension Mode



To change the suspension feel, press the button on the steering wheel. The first press displays a pop-up message in the instrument cluster display of the selected mode and subsequent presses changes the selected mode.

Modes:

- Normal – Developed to complement vehicle response during daily driving.
- Sport – Slightly firmer suspension with emphasis on handling and control.
- Off-road – Maximizes suspension performance in extreme off-road environments.

Selecting an Exhaust Mode



To change the exhaust sound, press the button on the steering wheel. The first press displays a pop-up message in the instrument cluster display of the selected mode and subsequent presses changes the selected mode.

Modes:

- Normal – Default setting provides a balance of comfort and feedback.
- Sport – Slightly louder than normal for spirited driving.
- Baja – Loudest setting for off-road use only. Maximum exhaust noise under all driving conditions.
- Quiet – Quietest setting for maximum comfort under all driving conditions.

Quiet Start

Quiet start allows you to schedule when the exhaust mode turns on the quiet setting. The time window can be from 1 to 24 hours

Enabling and disabling quiet start:

1. Press Settings.
2. Press Vehicle.
3. Press Quiet Start.
4. Press Quiet Start.
5. Press Settings.

Setting quiet time:

1. Press Settings.
2. Press Vehicle.
3. Press Quiet Start.
4. Press Set Quiet Time.
5. Set your desired start and end times.

Drive Mode Control - Raptor

MyMode



You can use MyMode to create one custom vehicle configuration based on the current state of your vehicle.

When you have your vehicle configured to your desired settings, press and hold the button for a few seconds to save as MyMode.

Press the button twice to activate your saved MyMode.

You can check the saved MyMode settings with a single press of the button.

You can save the following settings as MyMode:

- Drive mode.
- Steering mode.
- Suspension mode.
- Exhaust mode.
- Four-wheel drive mode.
- Stop and start on or off.
- Rear electronic locking differential on or off.

Note: MyMode can only be set with configurations that are available for each drive mode. See **Drive Modes** (page 279).

Note: You can save or view MyMode at any time, regardless of your vehicle's speed or transmission selection, as long as your vehicle is running and it meets system conditions.

Note: When activating MyMode, your vehicle must meet all preconditions for the drive mode and various settings before it activates. A message appears if it does not meet system conditions.

DRIVE MODES

BAJA



For high speed off-road driving. Baja mode optimizes the throttle control for better response and torque delivery.

Four-wheel drive high (4H) is the default four-wheel drive mode. Four-wheel drive auto (4A) is not selectable in baja mode.

The front electronic locking differential is available below 25 mph (40 km/h) when in four-wheel drive low (4L). The rear electronic locking differential is available at any speed in all selectable four-wheel drive modes.

Note: Do not use this mode on dry, hard pavement. This could produce some vibration, driveline bind up, and potential excessive tire and vehicle wear depending on the four-wheel drive mode selection.

NORMAL



For everyday driving. This mode is the perfect balance of excitement, comfort and convenience. This is the default mode after each ignition cycle, the driveline settings remain the same prior to the ignition cycle.

Four-wheel drive auto (4A) is the default four-wheel drive mode. All four-wheel drive modes are selectable when in normal mode.

The front electronic locking differential is available below 25 mph (40 km/h) when in four-wheel drive low (4L). The rear electronic locking differential is available below 25 mph (40 km/h).

Note: The rear electronic locking differential is available at any speed when in four-wheel drive low (4L).

Drive Mode Control - Raptor

OFF-ROAD



For off-road driving through sand, loose gravel, mud or mixed off-road terrain. This mode optimizes accelerator pedal response, traction and stability controls in order to enhance vehicle performance in off-road environments. If your vehicle becomes stuck in deep conditions, this mode may assist with helping to get unstuck.

Four-wheel drive high is the default four-wheel drive mode. Four-wheel drive low is selectable in off-road mode.

Comfort is the default steering mode. All steering modes are available.

Off-road is the default suspension mode. All suspension modes are available.

Sport is the default exhaust mode. All exhaust modes are available.

The system tunes the engine and transmission control to off-road mode.

The system tunes the stability and traction control to off-road mode.

The electronic locking differential engages when you select this mode at any speed, and you can disengage it at any time using the button. See **Switching the Electronic Locking Differential On and Off** (page 210).

Note: Do not use this mode when driving on pavement or packed snow. This could cause driveline bind up and damage the system depending on the four-wheel drive mode selection. See **Four-Wheel Drive** (page 199).

ROCK CRAWL



For off-road driving and optimum rock climbing. Rock crawl mode optimizes throttle response and adjusts transmission shift points to provide additional control of your vehicle.

Four-wheel drive low (4L) is the only four-wheel drive mode available in rock crawl mode.

Comfort is the default steering mode. All steering modes are available.

Off-road is the default suspension mode. All suspension modes are available.

Normal is the default exhaust mode. All exhaust modes are available.

The front electronic locking differential is available below 25 mph (40 km/h) when in four-wheel drive low (4L). The rear electronic locking differential is engaged when in rock crawl mode and is available at any speed.

SLIPPERY



For less than ideal conditions such as snow or ice. This mode can be used for crossing terrain where a firm surface is covered with loose or slippery material. Slippery mode lowers throttle response and optimizes shifting for slippery surfaces.

Four-wheel drive auto (4A) is the default four-wheel drive mode. Two-wheel drive high (2H) is not available.

The front electronic locking differential is available below 25 mph (40 km/h) when in four-wheel drive low (4L). The rear electronic locking differential is available below 25 mph (40 km/h).

Drive Mode Control - Raptor

Note: *The rear electronic locking differential is available at any speed when in four-wheel drive low (4L).*

Note: *Do not use this mode on hard pavement while in four-wheel drive high (4H) or four-wheel drive low (4L). This could produce some vibration, driveline bind up, and potential excessive tire and vehicle wear depending on the four-wheel drive mode selection.*

The electronic locking differential is available below 25 mph (40 km/h). See **Switching the Electronic Locking Differential On and Off** (page 210).

SPORT



For sporty driving with improved performance handling and response. This mode increases accelerator pedal response and provides a sportier steering feel. The powertrain system holds onto lower gears longer, helping your vehicle accelerate faster.

Two-wheel drive auto (2H) is the default four-wheel drive mode. Four-wheel drive low (4L) is not selectable in sport mode.

TOW/HAUL



For improved transmission operation when towing a trailer or a heavy load. This mode moves upshifts to higher engine speeds to reduce the frequency of transmission shifting. This mode also provides engine braking in all forward gears, which slows your vehicle and assists you in controlling your vehicle when descending a slope. The amount of downshift braking provided varies based on the amount you press the brake pedal.

Four-wheel drive auto (4A) is the default four-wheel drive mode. All four-wheel drive modes are selectable in tow/haul mode.

The system tunes the steering and suspension to enhance driving comfort when towing or carrying heavy loads.

Intelligent Speed Limiter (If Equipped)

WHAT IS THE INTELLIGENT SPEED LIMITER

The system allows you to limit the vehicle speed to the maximum speed limit detected by the traffic sign recognition system.

HOW DOES THE INTELLIGENT SPEED LIMITER WORK

Intelligent speed limiter uses data from the traffic sign recognition system to set a maximum speed. For example, if the traffic sign recognition system detects a 50 mph (80 km/h) speed limit, the vehicle speed is limited to 50 mph (80 km/h).

INTELLIGENT SPEED LIMITER PRECAUTIONS



WARNING: When you are going downhill, your vehicle speed may increase above the set speed. The system will not apply the brakes but a warning displays. Failure to follow this warning could result in serious personal injury or death.



WARNING: You are responsible for controlling your vehicle at all times. The system is designed to be an aid and does not relieve you of your responsibility to drive with due care and attention. Failure to follow this instruction could result in the loss of control of your vehicle, personal injury or death.

Note: *The system does not limit your vehicle's speed to speed limits shown with a supplementary traffic sign.*

SWITCHING THE INTELLIGENT SPEED LIMITER ON AND OFF



Press to switch the system on.

The system activates with the detected speed limit or, if no speed limit is detected the current speed of your vehicle is set. Press again to switch the system off.

SETTING THE SPEED LIMIT



Press the toggle button upward or downward with the system in standby mode to set the speed limiter to the current vehicle speed. The set speed is stored and displayed in the instrument



cluster.

Note: *The set speed limiter adjusts when the system detects a different maximum speed limit.*

Note: *If the system cannot detect a maximum speed limit, the system returns to standby mode.*

CHANGING THE SET SPEED LIMIT



You can adjust the set speed in small or large increments. Press the toggle button upward or downward once to adjust the set speed in small increments. Press and hold the toggle button upward or downward to adjust the set speed in large increments.



Intelligent Speed Limiter (If Equipped)

ADJUSTING THE SPEED LIMIT TOLERANCE

-  Press the button on the touchscreen.
- Press **Driver Assistance**.
- Press **Speed Limit Assist**.
- Switch **Intelligent Speed Limiter** on.
- Use the slider bar to adjust the allowable tolerance for the system.

CANCELING THE SET SPEED LIMIT

-  Press to cancel the limiter and place it in standby mode. The symbol in instrument cluster display appears grey.

RESUMING THE SET SPEED LIMIT

-  Press to resume the limiter. The system sets the speed limit to the detected maximum speed limit when it resumes. The symbol in the instrument cluster display appears green.

INTENTIONALLY EXCEEDING THE SET SPEED LIMIT

Firmly press the accelerator pedal to temporarily turn the system off. The system reactivates once your vehicle speed drops below the set speed.

INTELLIGENT SPEED LIMITER INDICATORS

-  It illuminates in the instrument cluster when the system is in standby or active.

INTELLIGENT SPEED LIMITER AUDIBLE WARNINGS

A warning appears in the instrument cluster and a tone sounds if any of the following occur:

- Your vehicle's speed exceeds the current set speed.
- The system detects a maximum speed limit that is lower than your vehicle's current speed. A tone sounds when your vehicle speed remains above the speed limit for 30 seconds.
- You intentionally exceed the set speed.

If the traffic sign recognition system detects a speed limit outside the operational speed range, 15–113 mph (24–182 km/h), a single warning tone sounds and the system switches to standby mode.

SWITCHING FROM INTELLIGENT SPEED LIMITER TO SPEED LIMITER

-  Press the button on the touchscreen.
- Press **Driver Assistance**.
- Press **Speed Limit Assist**.
- Switch **Intelligent Speed Limiter** off.

Intelligent Speed Limiter (If Equipped)

Note: *If you switch intelligent speed limiter off, the system defaults to manual speed limiter. You can manually set the speed limiter using the controls on the steering wheel.*

INTELLIGENT SPEED LIMITER – TROUBLESHOOTING

INTELLIGENT SPEED LIMITER – FREQUENTLY ASKED QUESTIONS

Why does a warning appear in the instrument cluster display?

- The vehicle speed exceeds the current set speed.
- The system detects a maximum speed limit that is lower than the current vehicle speed.
- You intentionally exceed the set speed.

Lane Keeping System

WHAT IS THE LANE KEEPING SYSTEM

The lane keeping system alerts you by providing temporary steering assistance or steering wheel vibration when it detects an unintended lane departure.

HOW DOES THE LANE KEEPING SYSTEM WORK

The lane keeping system uses a forward looking camera mounted on the windshield to monitor vehicle movement within the lane of travel.

When the camera detects a drift out of the lane of travel, the lane keeping system alerts the driver by vibrating the steering wheel, or aids the driver by providing a small steering input to move the vehicle back into the lane of travel.

The driver can select one of three modes:

- Alert
- Aid
- Alert + Aid

LANE KEEPING SYSTEM PRECAUTIONS

 **WARNING:** You are responsible for controlling your vehicle at all times. The system is designed to be an aid and does not relieve you of your responsibility to drive with due care and attention. Failure to follow this instruction could result in the loss of control of your vehicle, personal injury or death.

 **WARNING:** The system will not operate if the sensor cannot track the road lane markings.

 **WARNING:** The sensor may incorrectly track lane markings as other structures or objects. This can result in a false or missed warning.

 **WARNING:** In cold and severe weather conditions the system may not function. Rain, snow and spray can all limit sensor performance.

 **WARNING:** The system may not operate properly if the sensor is blocked. Keep the windshield free from obstruction.

 **WARNING:** If damage occurs in the immediate area surrounding the sensor, have your vehicle checked as soon as possible.

 **WARNING:** The system may not correctly operate if your vehicle is fitted with a suspension kit not approved by us.

 **WARNING:** Large contrasts in outside lighting can limit sensor performance.

LANE KEEPING SYSTEM LIMITATIONS

The lane keeping system only operates when the vehicle speed is greater than 40 mph (64 km/h).

The system works when the camera can detect at least one lane marking or the edge of the road.

Lane Keeping System

Note: When you select Aid or Alert and Aid mode and the system detects no steering activity for a short period of time, the system alerts you to put your hands on the steering wheel. The system may detect a light grip or touch on the steering wheel as hands-off driving.

The lane keeping system may not correctly operate in any of the following conditions:

- The lane keeping system does not detect at least one lane marking.
- You switch the turn signal on.
- You apply direct steering, accelerate fast or brake hard.
- The vehicle speed is less than 40 mph (64 km/h).
- The anti-lock brake, stability control or traction control system activates.
- The lane is too narrow.
- Something is obscuring the camera or it is unable to detect the lane markings due to environment, traffic or vehicle conditions.
- Entering or exiting a tight curve when driving at high speeds.

The lane keeping system may not correct lane positioning in any of the following conditions:

- High winds.
- Uneven road surfaces.
- Heavy or uneven loads.
- Incorrect tire pressure.

SWITCHING THE LANE KEEPING SYSTEM ON AND OFF



To activate the lane keeping system, press the button on the steering wheel.

To deactivate the lane keeping system, press the button again.

Note: When switching the system on or off a message appears in the instrument cluster display to show the status.

Note: The system stores the on or off setting until manually changed.

SWITCHING THE LANE KEEPING SYSTEM MODE

The lane keeping system has different settings that you can view or adjust using the information display.

- Alert (If Equipped)
- Aid
- Alert and Aid

The system permanently stores the last known selection for each setting.

To change the lane keeping system mode:

1.  Press the button on the touchscreen.
2. Press **Driver Assistance**.
3. Press **Lane-Keeping System**.
4. Press **Lane-Keeping Mode**.
5. Select a setting.

Note: The system remembers the last setting when you start your vehicle.

LANE KEEPING SYSTEM SETTINGS

Adjusting the Steering Wheel Vibration Intensity

1.  Press the button on the touchscreen.

Lane Keeping System

2. Press **Driver Assistance**.
3. Press **Lane-Keeping System**.
4. Press **Lane-Keeping Intensity**.
5. Select a setting.

Note: This setting is not available in all modes.

ALERT MODE

WHAT IS ALERT MODE

Alert mode vibrates the steering wheel when it detects an unintended lane departure.

HOW DOES ALERT MODE WORK

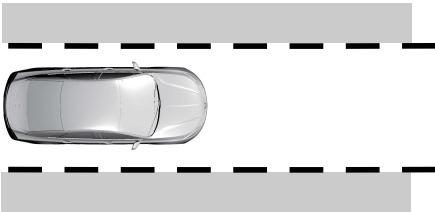

When in alert mode, the lane keeping system alerts you by vibrating the steering wheel. The intensity of the vibration is set through the lane keeping system menu.

AID MODE

WHAT IS AID MODE

Aid mode provides temporary steering assistance toward the center of the lane.

HOW DOES AID MODE WORK

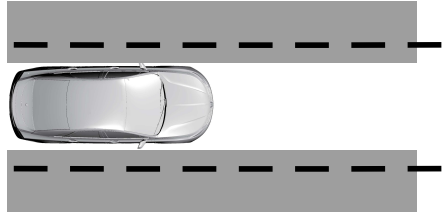

The lane keeping system aids you when an unintentional lane departure occurs. The system provides a small steering input to move the vehicle towards the center of the lane.

ALERT AND AID MODE

WHAT IS ALERT AND AID MODE

Alert and aid mode uses multiple features to keep you in your lane. The system first provides a small steering input to bring your vehicle back towards the center of the lane. If your vehicle moves too far from the center of the lane the system alerts you with vibration in the steering wheel.

Lane Keeping System

HOW DOES ALERT AND AID MODE WORK

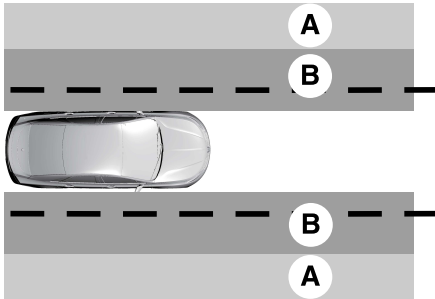

- A Alert.
- B Aid.

The lane keeping system detects a lane departure and provides aid when the vehicles enters **B** and applies the additional alert warning if **A** is entered.

LANE KEEPING SYSTEM INDICATORS

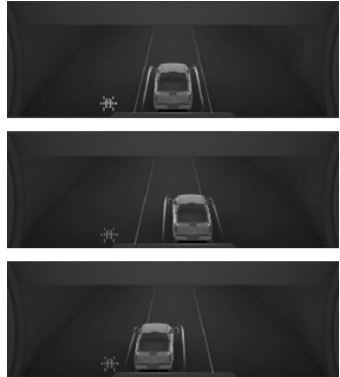

If you switch the lane keeping system on, a graphic with lane markings appears in the instrument cluster display.

When you switch the system off, the lane marking graphics do not display.

Note: *The overhead vehicle graphic may still display if adaptive cruise control is enabled.*

While the lane keeping system is on, the color of the lane markings change to indicate the system status.

Gray	Green	Orange	Red
Indicates that the system is temporarily unavailable to provide a warning or intervention on the indicated side.	Indicates that the system is available or ready to provide a warning or intervention on the indicated side.	Indicates that the system is providing or has just provided a lane keeping aid intervention.	Indicates that the system is providing or has just provided a lane keeping alert warning.

Lane Keeping System

BLIND SPOT ASSIST (IF EQUIPPED)

WHAT IS BLIND SPOT ASSIST

Blind spot assist is an extension of the lane keeping system.

It may help you identify adjacent vehicles during a lane change.

Blind spot assist provides a blind spot warning and steering assistance to help you become aware of and steer away from vehicles in your blind spot during lane changes.

HOW DOES BLIND SPOT ASSIST WORK



Activate and deactivate the system using the lane keeping system button on the steering

wheel.

During lane changes, the design of the blind spot assist feature detects vehicles in, or approaching, your blind spot and provides a warning, plus steering assistance to direct your vehicle back into your lane.

When active, this system functions with or without the use of turn signals and hazard flashers.

You must keep your hands on the steering wheel at all times.

BLIND SPOT ASSIST LIMITATIONS

All system limitations present in the basic lane keeping system also apply to blind spot assist.

Blind spot assist does not function under the following conditions:

- No lane markings are detected.
- One or both rear radar sensors become blocked or faulty.
- Attaching bike or cargo racks could cause false alerts due to obstruction of the sensor.

Blind spot assist may have difficulty detecting hazards under the following conditions:

- If a vehicle is approaching in an adjacent lane at a speed higher than your vehicle.
- Bad weather obstructing the sensors.

Lane Keeping System

BLIND SPOT ASSIST INDICATORS

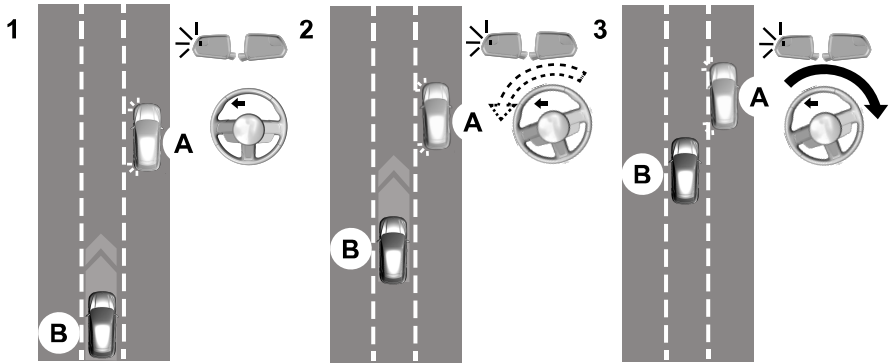

Diagram 1: Vehicle A uses its left turn signal preparing to change from the right lane to the middle lane. Vehicle B is already in the middle lane and just entered Vehicle A's blind spot causing the blind spot information system alert indicator to flash on the exterior mirror.

Diagram 2: The driver of Vehicle A begins to steer into the center lane not aware of Vehicle B.

Diagram 3: Blind spot assist counter steers to help alert the driver of Vehicle A to direct their vehicle back into the right lane to help avoid a possible collision with Vehicle B.

The lane keeping aid warning lamp or yellow lane marking in your instrument cluster display indicate blind spot assist activation. In addition, the blind spot information system alert indicator flashes on the exterior mirror on the same side as the detection. See **Blind Spot Information System** (page 301).

Blind Spot Assist Information Messages

Message	Action
Blind Spot Assist Not Available Trailer Attached	Displays if you attach a trailer to your vehicle with the blind spot information system switched off or you have not configured the trailer.
Blind Spot Assist Not Available Side Sensor Blocked	Displays if your blind spot information system sensors are blocked.
Blind Spot Assist System fault	The system has detected a fault that requires service. Have your vehicle checked as soon as possible.

Lane Keeping System

Message	Action
Trailer Brake Module Fault	Lost communication with the trailer module. Blind spot assist is suppressed until the failure is fixed.
Trailer Lighting Module Fault See Manual	Lost communication with the trailer module. Blind spot assist is suppressed until the failure is fixed.
Front Camera Fault Service Required	Front camera fault. Blind spot assist is disabled until the failure is fixed.

BLIND SPOT ASSIST WITH TRAILER COVERAGE (IF EQUIPPED)

WHAT IS BLIND SPOT ASSIST WITH TRAILER COVERAGE

Blind spot assist with trailer coverage is an extension of the lane keeping system.

It may help you identify adjacent vehicles during a lane change.

Blind spot assist provides a blind spot warning and steering assistance to help you become aware of and steer away from vehicles in your blind spot during lane changes.

When attaching a trailer, ensure you have properly set up the trailer coverage settings. See **Blind Spot Information System With Trailer Coverage** (page 303).

HOW DOES BLIND SPOT ASSIST WITH TRAILER COVERAGE WORK



Activate and deactivate the system using the lane keeping system button on the steering wheel.

During lane changes, the design of the blind spot assist feature detects vehicles in, or approaching, your blind spot and provides a warning, plus steering assistance to direct your vehicle back into your lane.

If a supported trailer is connected, the function is reduced to only detecting vehicles on both sides of your vehicle and trailer, extending rearward from the exterior mirrors to the end of your trailer. See **Blind Spot Information System With Trailer Coverage** (page 303).

When active, this system functions with or without the use of direction indicators and hazard flashers.

You must keep your hands on the steering wheel at all times.

BLIND SPOT ASSIST WITH TRAILER COVERAGE LIMITATIONS

All system limitations present in the basic lane keeping system also apply to blind spot assist.

Blind spot assist does not function under the following conditions:

Lane Keeping System

- No lane markings are detected.
- One or both rear radar sensors become blocked or faulty.
- You have not configured the attached trailer correctly in the trailer tow menus or you attached an unsupported trailer. The system only supports certain trailer shapes and dimensions.

Note: *Blind spot assist with trailer coverage could have reduced performance if any of the above limitations are present.*

Blind spot assist may have difficulty detecting hazards under the following conditions:

- If a vehicle is approaching in an adjacent lane at a relative speed much higher than your vehicle.
- Bad weather conditions are present that obstruct the sensors.
- Attaching bike or cargo racks could cause false alerts due to obstruction of the sensor.

BLIND SPOT ASSIST WITH TRAILER COVERAGE INDICATORS

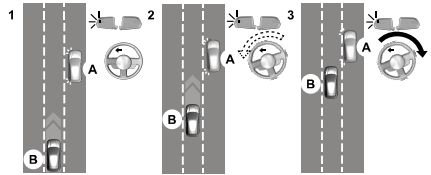

Diagram 1: Vehicle A uses its left turn signal preparing to change from the right lane to the middle lane. Vehicle B is already in the middle lane and just entered Vehicle A's blind spot causing the blind spot information system alert indicator to flash on the exterior mirror.

Diagram 2: The driver of Vehicle A begins to steer into the center lane not aware of Vehicle B.

Diagram 3: Blind spot assist counter steers to help alert the driver of Vehicle A to direct their vehicle back into the right lane to help avoid a possible collision with Vehicle B.

The lane keeping aid warning lamp or yellow lane marking in your instrument cluster display indicate blind spot assist activation. In addition, the blind spot information system alert indicator flashes on the exterior mirror on the same side as the detection. See **Blind Spot Information System** (page 301).

Lane Keeping System

Blind Spot Assist Information Messages

Message	Action
Blind Spot Assist Not Available Trailer Attached	Displays if you attach a trailer to your vehicle with the blind spot information system switched off or you have not configured the trailer.
Blind Spot Assist Not Available Side Sensor Blocked	Displays if your blind spot information system sensors are blocked.
Blind Spot Assist System fault	The system has detected a fault that requires service. Have your vehicle checked as soon as possible.
Trailer Brake Module Fault	Lost communication with the trailer module. Blind spot assist is disabled until the failure is fixed.
Trailer Lighting Module Fault See Manual	Lost communication with the trailer module. Blind spot assist is disabled until the failure is fixed.
Front Camera Fault Service Required	Front camera fault. Blind spot assist is disabled until the failure is fixed.

LANE KEEPING SYSTEM – TROUBLESHOOTING

LANE KEEPING SYSTEM – INFORMATION MESSAGES

Message	Action
Lane Keeping Sys. Malfunction Service Required	The system has malfunctioned. Have your vehicle checked as soon as possible.
Front Camera Temporarily Not Available	The system has detected a condition that has caused the system to be temporarily unavailable.
Front Camera Low Visibility Clean Screen	The system has detected a condition that requires you to clean the windshield in order for it to operate properly.
Front Camera Malfunction Service Required	The system has malfunctioned. Have your vehicle checked as soon as possible.
Keep Hands on Steering Wheel	The system requests that you keep your hands on the steering wheel.

Lane Keeping System

LANE KEEPING SYSTEM – FREQUENTLY ASKED QUESTIONS

Why is the feature not available (lane markings are gray) when I can see the lane markings on the road?
Your vehicle speed is less than 40 mph (65 km/h).
The sun is shining directly into the camera lens.
A quick intentional lane change has occurred.
Your vehicle stays too close to the lane markings for an extended interval of time.
Driving at high speeds in curves.
The last alert warning or aid intervention occurred a short time ago.
Ambiguous lane markings, for example, in construction zones.
Rapid transition from light to dark, or from dark to light.
Sudden offset in lane markings.
ABS or AdvanceTrac™ is active.
There is a camera blockage due to dirt, grime, fog, frost or water on the windshield.
You are driving too close to the vehicle in front of you.
Transitioning between no lane markings to lane markings, or vice versa.
There is standing water on the road.
Faint lane markings, for example, partial yellow lane markings on concrete roads.
Lane width is too narrow or too wide.
You have not calibrated the camera after a windshield replacement.
Driving on tight or on uneven roads.

Lane Keeping System

Why does the vehicle not come back toward the middle of the lane, as expected, in the Aid, or Aid + Alert mode?
High cross winds are present.
There is a large road crown.
Rough roads, grooves or shoulder drop-offs.
Heavy, uneven loading of the vehicle or improper tire inflation pressure.
You changed the tires or modified the suspension.

Blind Spot Information System (If Equipped)

WHAT IS BLIND SPOT INFORMATION SYSTEM

Blind spot information system detects vehicles that may have entered the blind spot zone.

HOW DOES BLIND SPOT INFORMATION SYSTEM WORK

Blind spot information system uses sensors on both sides of your vehicle, detecting rearward from the exterior mirrors to approximately 13 ft (4 m) beyond the rear bumper. The detection area extends to approximately 59 ft (18 m) beyond the rear bumper when the vehicle speed is greater than 30 mph (48 km/h) to alert you of faster approaching vehicles.

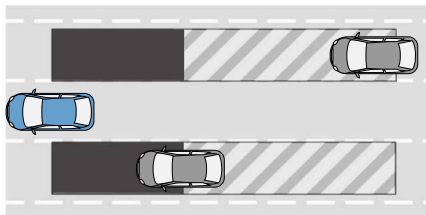

BLIND SPOT INFORMATION SYSTEM PRECAUTIONS



WARNING: Do not use the blind spot information system as a replacement for using the interior and exterior mirrors or looking over your shoulder before changing lanes. The blind spot information system is not a replacement for careful driving.



WARNING: The system may not operate properly during severe weather conditions, for example snow, ice, heavy rain and spray. Always drive with due care and attention. Failure to take care may result in a crash.

Note: *Blind spot information system does not prevent contact with other vehicles. It does not detect parked vehicles, pedestrians, animals or other infrastructure.*

BLIND SPOT INFORMATION SYSTEM LIMITATIONS

Blind spot information system does not operate in park (P) or reverse (R).

The system may not alert you if a vehicle quickly passes through the detection zone.

BLIND SPOT INFORMATION SYSTEM REQUIREMENTS

Vehicles with Automatic Transmission

Blind spot information system turns on when all the following occur:

- You start your vehicle.
- You shift into drive (D).
- The vehicle speed is greater than 6 mph (10 km/h).

Note: *The system does not operate in park (P) or reverse (R).*

Blind Spot Information System (If Equipped)

Vehicles with Manual Transmission (If Equipped)

Blind spot information system turns on when all the following occur:

- You start your vehicle.
- The vehicle speed is greater than 6 mph (10 km/h).

Note: The system does not operate in reverse (R).

SWITCHING BLIND SPOT INFORMATION SYSTEM ON AND OFF

1.  Press the button on the touchscreen.
2. Press **Driver Assistance**.
3. Switch **Blind Spot Information System** on or off.

When you switch blind spot information system off, a warning lamp illuminates. When you switch the system on or off, the alert indicators flash twice.

Note: The system remembers the last setting when you start your vehicle.

LOCATING THE BLIND SPOT INFORMATION SYSTEM SENSORS



The sensors are inside the brake lamp on both sides of your vehicle.

Note: Keep the sensors free from snow, ice and large accumulations of dirt.

Note: Do not cover the sensors with bumper stickers, repair compound or other objects.

Note: Bike and cargo racks could cause false alerts due to obstruction of the sensor. We recommend switching the feature off when using a bike or cargo rack.

Note: Blocked sensors may affect system accuracy.

If the sensors become blocked, a message appears in the instrument cluster display. See **Blind Spot Information System – Information Messages** (page 306). The alert indicators illuminate but the system does not alert you.

Blind Spot Information System (If Equipped)

BLIND SPOT INFORMATION SYSTEM WITH TRAILER COVERAGE (IF EQUIPPED)

WHAT IS BLIND SPOT INFORMATION SYSTEM WITH TRAILER COVERAGE

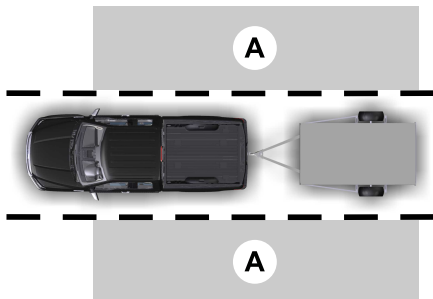

A. Trailer coverage detection zone.

Blind spot information system detects vehicles that may have entered the blind spot zone. The detection area is on both sides your vehicle and trailer, extending rearward from the exterior mirrors to the end of your trailer.

HOW DOES BLIND SPOT INFORMATION SYSTEM WITH TRAILER COVERAGE WORK

The blind spot information system with trailer coverage is designed to detect vehicles that could have entered the blind spot zone. The detection area is on both sides of your vehicle and trailer, extending rearward from the exterior mirrors to the end of your trailer. When you attach a trailer and have set up a trailer, the blind spot information system with trailer tow becomes active when driving forward above 6 mph (10 km/h).

You can set up the trailer length, select a trailer or switch blind spot information system with trailer tow off.

BLIND SPOT INFORMATION SYSTEM WITH TRAILER COVERAGE LIMITATIONS

Trailer coverage only supports conventional trailers. The system turns off if you select a fifth wheel or gooseneck trailer type.

Make sure the trailer width is less than or equal to 8 ft (2.4 m) and the length is less than 33 ft (10.1 m). If you input values higher, the system turns off.

Some trailers could cause a slight change in system performance:

- Large box trailers could cause false alerts to occur when driving next to infrastructures or near parked cars. A false alert could also occur while making a 90-degree turn.
- Trailers that have a width greater than 8 ft (2.4 m) at the front and have a total length greater than 20 ft (6 m) could cause delayed alerts when a vehicle is passing at high speeds.
- Box trailers that have a width greater than 8 ft (2.4 m) at the front could cause early alerts when you pass a vehicle.
- Clamshell or V-nose box trailers with a width greater than 8 ft (2.4 m) at the front could cause delayed alerts when a vehicle traveling the same speed as your vehicle merges lanes.

Blind Spot Information System (If Equipped)

SWITCHING BLIND SPOT INFORMATION SYSTEM WITH TRAILER COVERAGE ON AND OFF

-  Press the button on the touchscreen.
- Press **Driver Assistance**.
- Switch **Blind Spot Information System** on or off.

Note: Some vehicles may not have the ability to switch the feature on or off.

When you switch the system off, a warning lamp illuminates and the alert indicators flash twice.

Note: The system turns off and a message appears when a trailer is connected, but not set up or selected.

SETTING A TRAILER LENGTH

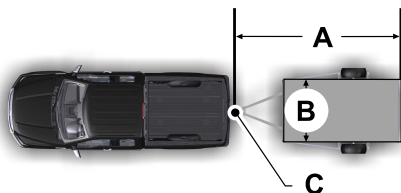

- A Trailer length.
- B Trailer width.
- C Trailer hitch ball.

You can set up a trailer to work with the blind spot information system through the touchscreen. When setting up a trailer, a sequence of screens appear asking for trailer information.

- Select the type of trailer; conventional, fifth wheel or gooseneck.

Note: The system only supports a conventional trailer.

- Do you want to set up blind spot with trailer screen? No, the system turns off. Yes, the system takes you to the next screen.
- Is the width less than or equal to 8 ft (2.4 m) and the length less than or equal to 33 ft (10 m)? Yes, the system takes you to the next screen. No, the system turns off.
- Trailer width measurement. Measure the width at the front of the trailer. The maximum width the system can support is 7.9 ft (2.4 m).

Note: You do not need to enter an exact trailer width measurement. You only need to confirm the width of the trailer is less than or equal to 8 ft (2.4 m).

- Trailer length measurement. The trailer length is the distance between the trailer hitch ball and the rear of the trailer. The maximum length the system can support is 33 ft (10 m).
- Enter the length of trailer. The default setting is 25 ft (7.6 m). Select a length that is equal to or within 3 ft (1 m) of the actual measured length. For example, if the actual measured length is 25 ft (7.5 m), toggle the length in the menu to 27 ft (8.2 m). The system setup saves when you enter the trailer length.

Note: If the trailer is a bike rack or cargo rack with electrical lighting, enter a length of 3 ft (1 m). Cross traffic alert remains on for trailers with a length of 3 ft (1 m) or less.

Note: The system requires that you enter the correct measurement for it to properly function.

Blind Spot Information System (If Equipped)

SELECTING A TRAILER

When you connect a trailer to your vehicle, the trailer set up menu appears in the touchscreen. This menu allows you to set up a new trailer or choose from a previously set up trailer. A warning message appears and the system turns off if you do not choose or add a new trailer.

Note: *The warning message may not appear until your vehicle reaches 22 mph (35 km/h).*

BLIND SPOT INFORMATION SYSTEM INDICATORS



When blind spot information system detects a vehicle, an alert indicator illuminates in the exterior mirror on the side from which the vehicle is approaching. If you turn the turn signal on for that side of your vehicle, the alert indicator flashes.

BLIND SPOT INFORMATION SYSTEM – TROUBLESHOOTING

BLIND SPOT INFORMATION SYSTEM – WARNING LAMPS



If the system detects a fault, it illuminates in the instrument cluster and a message appears in the instrument cluster display. Have your vehicle checked as soon as possible.

Blind Spot Information System (If Equipped)

BLIND SPOT INFORMATION SYSTEM – INFORMATION MESSAGES

Message	Action
Blind Spot System Fault	A fault with the system has occurred. Have your vehicle checked as soon as possible.
Blind Spot Not Available Sensor Blocked See Manual	Something is blocking the sensors. Clean the sensors.
Blind Spot Alert Deactivated Trailer Attached	The system automatically turns off and displays this message when you connect a trailer to your vehicle under any of the following conditions: <ul style="list-style-type: none">- Your vehicle does not have blind spot information system with trailer coverage.- You switch the blind spot information system off through the touchscreen.- Your trailer exceeds the limits for the system. See Setting a Trailer Length (page 304).

Note: When connecting a trailer, the system may detect the trailer and turn the system OFF. If the system does not automatically turn OFF, manually switch the blind spot information system OFF. If your vehicle has the blind spot information system with trailer coverage, the system prompts you to set up a trailer that allows the feature to function, if your trailer meets the requirements of the system.

Cross Traffic Alert (If Equipped)

WHAT IS CROSS TRAFFIC ALERT

The system alerts you of vehicles approaching from the sides behind your vehicle when you shift into reverse (R).

HOW DOES CROSS TRAFFIC ALERT WORK

Cross traffic alert detects vehicles that approach at a speed between 4–37 mph (6–60 km/h). Coverage decreases when the sensors are partially, mostly or fully obstructed.

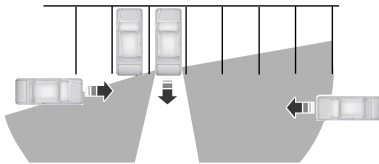

The sensor on the left-hand side is only partially obstructed and zone coverage on the right-hand side is maximized.

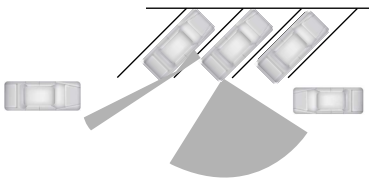

Zone coverage also decreases when parking at narrow angles. The sensor on the left-hand side is mostly obstructed and zone coverage on that side is severely reduced.

Note: *Slowly reversing helps increase the coverage area and effectiveness.*

CROSS TRAFFIC ALERT PRECAUTIONS

WARNING: Do not use the cross traffic alert system as a replacement for using the interior and exterior mirrors or looking over your shoulder before reversing out of a parking space. The cross traffic alert system is not a replacement for careful driving.

WARNING: The system may not operate properly during severe weather conditions, for example snow, ice, heavy rain and spray. Always drive with due care and attention. Failure to take care may result in a crash.

CROSS TRAFFIC ALERT LIMITATIONS

The system may not correctly operate when any of the following occur:

- Something is blocking the sensors.
- Adjacently parked vehicles or objects are obstructing the sensors.
- Vehicles approach at speeds less than 4 mph (6 km/h) or greater than 37 mph (60 km/h).
- Your vehicle speed is greater than 7 mph (12 km/h).
- You reverse out of an angled parking space.

Cross Traffic Alert (If Equipped)

Cross Traffic Alert Limitations with a Trailer Attached

The system remains on when you attach a trailer to vehicles with blind spot information system with trailer coverage under the following conditions:

- You connect a trailer.
- The trailer is a bike rack or cargo rack with a maximum length of 3 ft (1 m).
- You set the trailer length to 3 ft (1 m) in the instrument cluster display.

Note: *The system may not correctly operate when towing a trailer. For vehicles with a trailer tow module and tow bar approved by the manufacturer, the system turns off when you attach a trailer. For vehicles with an aftermarket trailer tow module or tow bar, we recommend that you switch the system off when you attach a trailer.*

SWITCHING CROSS TRAFFIC ALERT ON AND OFF

1.  Press the button on the touchscreen.
2. Press **Driver Assistance**.
3. Switch **Cross Traffic Alert** on or off.

When you switch the system on or off, the alert indicators flash twice.

Note: *The system turns on every time you start your vehicle.*

LOCATING THE CROSS TRAFFIC ALERT SENSORS

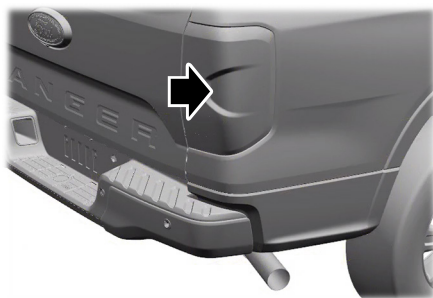

The sensors are inside the brake lamp on both sides of your vehicle.

Note: *Keep the sensors free from snow, ice and large accumulations of dirt.*

Note: *Do not cover the sensors with bumper stickers, repair compound or other objects.*

Note: *Blocked sensors may affect system accuracy.*

If something is blocking the sensors, a message may appear in the information display when you shift into reverse (R).

Note: *Bike and cargo racks could cause false alerts due to obstruction of the sensor. We recommend switching the feature off when using a bike or cargo rack.*

CROSS TRAFFIC ALERT INDICATORS

When the cross traffic alert detects an approaching vehicle, a tone sounds, a warning lamp illuminates in the relevant exterior mirror and arrows appear in the instrument cluster display to show from which side the vehicle is approaching.

Cross Traffic Alert (If Equipped)

If the system malfunctions, a warning lamp illuminates in the instrument cluster and a message appears in the instrument cluster display. Have your vehicle checked as soon as possible.

Note: *In some conditions, the system could alert you, even when there is nothing in the detection zone, for example a vehicle passing further away from your vehicle.*

CROSS TRAFFIC ALERT – TROUBLESHOOTING

CROSS TRAFFIC ALERT – INFORMATION MESSAGES

Message	Action
Cross Traffic Alert	Displays instead of indication arrows when the system detects a vehicle. Check for approaching traffic. Only available in vehicles with 8 inch displays.
Cross Traffic Not Available Sensor Blocked See Manual	Indicates blocked cross traffic alert system sensors. Clean the sensors. If the message continues to appear, have your vehicle checked as soon as possible.
Cross Traffic System Fault	The system has malfunctioned. Have your vehicle checked as soon as possible.
Cross Traffic Alert Deactivated Trailer Attached	Displays if you attach a trailer to your vehicle.

Note: *When connecting a trailer, the system may detect the trailer and turn the system OFF. If the system does not turn OFF automatically, switch the cross traffic alert system OFF manually. See **Switching Cross Traffic Alert On and Off** (page 308).*

Pre-Collision Assist

WHAT IS PRE-COLLISION ASSIST

Pre-collision assist detects and warns of approaching hazards in the roadway. If your vehicle is rapidly approaching another stationary vehicle, a vehicle traveling in the same direction as yours, or a pedestrian within your driving path, the system provides multiple levels of assistance to help avoid a collision.

HOW DOES PRE-COLLISION ASSIST WORK

The system warns the driver of potential hazards by providing three levels of assistance.



If your vehicle is rapidly approaching potential hazards, the system provides the following levels of functionality:

1. Alert.
2. Brake Support.
3. Automatic Emergency Braking.



Alert: When active, a flashing visual warning appears and an audible warning tone sounds.

Brake Support: The system is designed to help reduce the impact speed by preparing the brakes for rapid braking. The system does not automatically apply the brakes. If you press the brake pedal, the system could apply additional braking up to maximum braking force, even if you lightly press the brake pedal.

Automatic Emergency Braking: This may activate if the system determines that a collision is imminent.

Note: If you perceive the pre-collision assist alerts as being too frequent or disturbing, then you can reduce the alert sensitivity. Setting the low sensitivity would result in fewer and later warnings of a potential forward collision. The manufacturer recommends using the high sensitivity setting where possible.

Note: Automatic emergency braking performance is not affected by the sensitivity setting.

Each system has various levels of detection capabilities. See **Pre-Collision Assist Limitations** (page 311).

PRE-COLLISION ASSIST PRECAUTIONS



WARNING: You are responsible for controlling your vehicle at all times. The system is designed to be an aid and does not relieve you of your responsibility to drive with due care and attention. Failure to follow this instruction could result in the loss of control of your vehicle, personal injury or death.



WARNING: The system does not detect vehicles moving in a different direction or animals. Apply the brakes when necessary. Failure to follow this instruction could result in the loss of control of your vehicle, personal injury or death.



WARNING: The system does not operate during hard acceleration or steering. Failure to take care may lead to a crash or personal injury.

Pre-Collision Assist



WARNING: The system may operate with reduced function during cold and inclement weather conditions. Snow, ice, rain, spray and fog can adversely affect the system. Keep the front camera and radar free of snow and ice. Failure to follow this instruction may result in the loss of control of your vehicle, serious personal injury or death.



WARNING: Take additional care if your vehicle is heavily loaded or you are towing a trailer. These conditions could result in reduced performance of this system. Failure to follow this instruction could result in the loss of control of your vehicle, personal injury or death.



WARNING: The system cannot help prevent all crashes. Do not rely on this system to replace driver judgment and the need to maintain a safe distance and speed.



WARNING: In situations where the vehicle camera has limited detection capability, this may reduce system performance. These situations include but are not limited to direct or low sunlight, vehicles at night without tail lights, unconventional vehicle types, pedestrians with complex backgrounds, running pedestrians, partly obscured pedestrians, or pedestrians that the system cannot distinguish from a group. Failure to take care may result in the loss of control of your vehicle, serious personal injury or death.

PRE-COLLISION ASSIST LIMITATIONS

Pre-collision assist depends on the detection ability of its camera and sensors. Any obstructions or damage to these areas can limit detection or prevent the system from functioning. See **Locating the Pre-Collision Assist Sensors** (page 312).

The system is active at 3 mph (5 km/h) and above.

Note: *The Pre-Collision Assist system disables when you select **4X4 LOW** or when you manually disable AdvanceTrac™.*

Note: *Brake support and automatic emergency braking are active at speeds up to 80 mph (130 km/h). If your vehicle has a radar sensor included with adaptive cruise control, then brake support and automatic emergency braking are active up to the maximum speed of the vehicle.*

Pedestrian Detection Limitations

Pedestrian detection is active at speeds up to 50 mph (80 km/h).

Pedestrian detection operates optimally when detected hazards are clearly identifiable. System performance may reduce in situations where pedestrians are running, partly obscured, have a complex background, or cannot be distinguished from a group.

Intersection Assist (If Equipped)

If your vehicle comes with the radar sensor included in the adaptive cruise control, pre-collision assist may operate to detect oncoming vehicles as you traverse intersections. Detection of vehicles driving in an oncoming direction is active if your vehicle is driving at speeds up to 50 mph (80 km/h).

Pre-Collision Assist

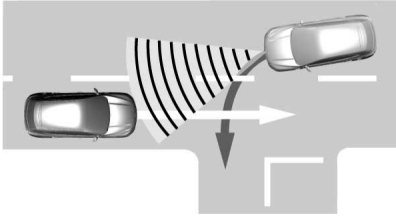

LOCATING THE PRE-COLLISION ASSIST SENSORS

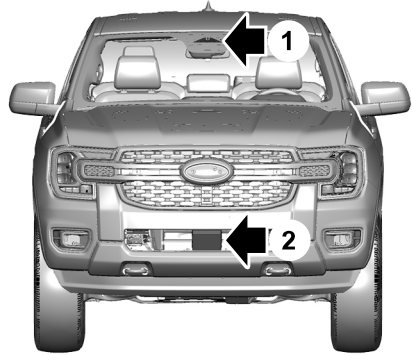

1. Camera.
2. Radar sensor (if equipped).

SWITCHING PRE-COLLISION ASSIST ON AND OFF

1.  Press the button on the touchscreen.
2. Press **Driver Assistance**.
3. Press **Pre-Collision Assist**.
4. Switch the feature on or off.

Adjusting the Pre-Collision Assist Settings

You can adjust the following settings by using the touchscreen controls in the pre-collision assist menu:

- Change alert sensitivity to one of three possible settings.
- If required, switch automatic emergency braking on or off.
- If required, switch the entire pre-collision assist feature on or off.

Note: Automatic emergency braking switches on every time you switch the ignition on.

If a message regarding a blocked sensor or camera appears in the instrument cluster, something is obstructing the radar signals or camera images. The radar sensor is located behind the fascia cover in the center of the lower grille. If a sensor or camera is blocked, the system may not function, or performance may reduce. See **Pre-Collision Assist – Information Messages** (page 316).

Note: Proper system operation requires the camera have a clear view of the road. Have any windshield damage in the area of the camera's field of view repaired.

Note: If something hits the front end of your vehicle or damage occurs and your vehicle has a radar sensor, the radar sensing zone could change. This could cause missed or false vehicle detections. Have your vehicle serviced to have the radar checked for proper coverage and operation.

Pre-Collision Assist

Note: If your vehicle detects excessive heat at the camera or a potential misalignment condition, a message could display in the instrument cluster indicating the sensor is temporarily unavailable. When operational conditions are correct, the message deactivates. For example, when the ambient temperature around the sensor decreases or the sensor recalibrates successfully.

DISTANCE INDICATION (IF EQUIPPED)

WHAT IS DISTANCE INDICATION

Distance indication displays the gap between your vehicle and the vehicle ahead of you.

Note: The graphic does not display if you switch on cruise control or adaptive cruise control.

Vehicle Speed	System Sensitivity	Distance Indicator Color	Distance Gap	Time Gap
62 mph (100 km/h).	Normal.	Gray.	Greater than 82 ft (25 m).	Greater than 0.9 seconds.
		Yellow.	56–82 ft (17–25 m).	0.6–0.9 seconds.
		Red.	Less than 56 ft (17 m).	Less than 0.6 seconds.

Pre-Collision Assist

SWITCHING DISTANCE INDICATION ON AND OFF

1.  Press the button on the touchscreen.
2. Press **Driver Assistance**.
3. Press **Pre-Collision Assist**.
4. Switch **Distance Indication** on or off.

DISTANCE INDICATION INDICATOR

The indicator displays the time gap between your vehicle and vehicles traveling in the same direction ahead of you.



DISTANCE ALERT (IF EQUIPPED)

WHAT IS DISTANCE ALERT

The system alerts you with a warning lamp if the distance to the vehicle ahead is small.

Note: *The warning lamp does not illuminate if cruise control or adaptive cruise control is active.*

Pre-Collision Assist

ADJUSTING THE SENSITIVITY OF DISTANCE ALERT

To adjust the sensitivity of the system:

1.  Press the button on the touchscreen.
2. Press **Driver Assistance**.
3. Press **Pre-Collision Assist**.
4. Press **Alert Sensitivity**.
5. Select a setting.

AUTOMATIC EMERGENCY BRAKING

WHAT IS AUTOMATIC EMERGENCY BRAKING

Automatic emergency braking may activate if the system determines that a collision is imminent. The system may help to reduce impact damage or avoid the crash completely.

Automatic emergency braking is only available up to certain speeds. See **Pre-Collision Assist Limitations** (page 311).

SWITCHING AUTOMATIC EMERGENCY BRAKING ON AND OFF

1.  Press the button on the touchscreen.
2. Press **Driver Assistance**.
3. Press **Pre-Collision Assist**.
4. Switch **Automatic Emergency Braking** on or off.

EVASIVE STEERING ASSIST (IF EQUIPPED)

WHAT IS EVASIVE STEERING ASSIST

If your vehicle is rapidly approaching a road user, evasive steering assist helps you steer around the road user.

After you turn the steering wheel in an attempt to avoid a crash with the road user, the system applies additional steering torque to help you steer around the road user. After you pass the road user, the system applies steering torque when you turn the steering wheel to steer back into the lane. The system deactivates after you fully pass the road user.

Note: *Road users are defined as pedestrians or bicyclists in your vehicle's path or another stationary vehicle in the same lane or a vehicle traveling in the same lane in the same direction as you. See **Pre-Collision Assist Precautions** (page 310).*

EVASIVE STEERING ASSIST LIMITATIONS

Evasive steering assist only activates when all the following occur:

- Automatic emergency braking and evasive steering assist are on.
- The system detects a road user ahead and starts to apply the brakes.
- You significantly turn the steering wheel to steer around a road user.

Note: *Evasive steering assist does not automatically steer around a road user. If you do not turn the steering wheel, evasive steering assist does not activate.*

Pre-Collision Assist

Note: *Evasive steering assist does not activate if the distance to the road user ahead is too small and the system cannot avoid a crash.*

SWITCHING EVASIVE STEERING ASSIST ON AND OFF

1.  Press the button on the touchscreen.
2. Press **Driver Assistance**.
3. Press **Pre-Collision Assist**.
4. Switch **Evasive Steering** on or off.

Note: *If you switch automatic emergency braking off, evasive steering assist turns off.*

Note: *Automatic emergency braking and evasive steering assist turn on every time you switch the power on.*

PRE-COLLISION ASSIST – TROUBLESHOOTING

PRE-COLLISION ASSIST – WARNING LAMPS



A telltale illuminates in the instrument cluster display to indicate if the system is disabled, unavailable, or temporarily degraded due to external environmental conditions.

Note: *No action is needed if the telltale illuminates without a corresponding information message. See **Pre-Collision Assist Precautions** (page 310).*

PRE-COLLISION ASSIST – INFORMATION MESSAGES

Message	Action
Pre-Collision Assist Not Available Sensor Blocked	You have a blocked sensor due to bad weather, ice, mud or water in front of the radar sensor. You can typically clean the sensor to resolve.
Pre-Collision Assist Not Available	A fault with the system has occurred. Have your vehicle checked as soon as possible.

Pre-Collision Assist

PRE-COLLISION ASSIST – FREQUENTLY ASKED QUESTIONS

Camera Troubleshooting

The windshield in front of the camera is dirty or obstructed.

- Clean the outside of the windshield in front of the camera.

The windshield in front of the camera is clean, but the message remains in the instrument cluster display.

- Wait a short time. It could take several minutes for the camera to detect that there is no obstruction.

Radar Troubleshooting (If Equipped)

The surface of the radar in the grille is dirty or obstructed.

- Clean the grille surface in front of the radar or remove the object causing the obstruction.

The surface of the radar in the grille is clean, but the message remains in the instrument cluster display.

- Wait a short time. It could take several minutes for the radar to detect that there is no obstruction.

Heavy rain, spray or fog is interfering with the radar signals.

- Due to the current conditions, the system temporarily disables this feature. Pre-collision assist reactivates a short time after the weather conditions improve.

Swirling water, snow or ice on the surface of the road is interfering with the radar signals.

- Due to the current conditions, the system temporarily disables this feature. Pre-collision assist reactivates a short time after the weather conditions improve.

Radar is out of alignment due to a front-end impact.

- Have your vehicle serviced to have the radar checked for proper coverage and operation.

Speed Sign Recognition (If Equipped)

WHAT IS SPEED SIGN RECOGNITION

Speed sign recognition detects speed limit signs to inform you of the current speed limit. Detected speed signs appear in the instrument cluster display.

HOW DOES SPEED SIGN RECOGNITION WORK

Speed sign recognition uses a sensor behind the interior mirror to detect speed signs.

If your vehicle has speed sign recognition with navigation, stored speed sign data may influence the indicated speed limit value.

SPEED SIGN RECOGNITION PRECAUTIONS



WARNING: You are responsible for controlling your vehicle at all times. The system is designed to be an aid and does not relieve you of your responsibility to drive with due care and attention. Failure to follow this instruction could result in the loss of control of your vehicle, personal injury or death.



WARNING: In cold and severe weather conditions the system may not function. Rain, snow and spray can all limit sensor performance.



WARNING: The system may not operate properly if the sensor is blocked. Keep the windshield free from obstruction.

Note: Do not carry out windshield repairs in the immediate area surrounding the sensor.

Note: If your vehicle has a suspension kit not approved by Ford, the system may not correctly function.

Note: The system may not detect all speed signs and may incorrectly read signs.

Note: Always fit our original parts when replacing headlamp bulbs. Other bulbs may reduce system performance.

SPEED SIGN RECOGNITION LIMITATIONS

Speed sign recognition may not operate correctly due to:

- Outdated map data.
- Incorrect recognition of speed limits by the sensor of signs on parallel roads or exit ramps.
- Missed recognition of faded, dirty, or distorted signs.

SPEED SIGN RECOGNITION INDICATORS



When the system detects a speed limit sign, it appears in the instrument cluster display.

Speed Sign Recognition (If Equipped)

Note: Sign indicator image may vary based on your vehicle's display type.

SETTING THE SPEED SIGN RECOGNITION SPEED WARNING

-  Press the button on the touchscreen.
- Press **Driver Assistance**.
- Press **Speed Limit Assist**.
- Select to switch the feature on or off.

SETTING THE SPEED SIGN RECOGNITION SPEED TOLERANCE

-  Press the button on the touchscreen.
- Press **Driver Assistance**.
- Press **Speed Limit Assist**.
- Press **Tolerance**.
- Use the slider bar to select the required level.

SPEED SIGN RECOGNITION – TROUBLESHOOTING

SPEED SIGN RECOGNITION – INFORMATION MESSAGES

Message	Details
Traffic Sign Reduced Performance See Manual	The traffic sign data provided by the navigation system is unavailable due to weak or no signal. Wait for a short period of time for the signal to improve. If the message continues to appear, have the system checked as soon as possible.

Speed Sign Recognition (If Equipped)

SPEED SIGN RECOGNITION – FREQUENTLY ASKED QUESTIONS

Why does the speed limit change without any sign on the road?

- The speed limit changes due to the speed limit data stored in the map data.

Why does speed sign recognition show a wrong speed limit?

- The system shows a wrong speed limit due to incorrect and outdated map data or due to incorrect recognition of the speed limits by the camera.

Driver Alert (If Equipped)

WHAT IS DRIVER ALERT

Driver alert alerts you if it determines that you are becoming drowsy or if your driving deteriorates.

HOW DOES DRIVER ALERT WORK

Driver alert uses a front camera sensor located behind the interior mirror to calculate your alertness level based on your driving behavior in relation to the lane markings and other factors.

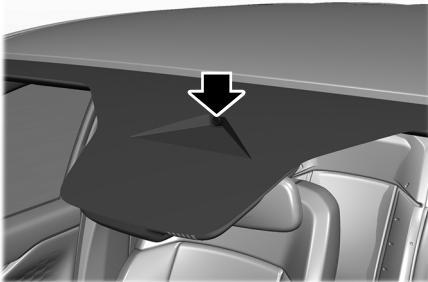

DRIVER ALERT PRECAUTIONS

WARNING: You are responsible for controlling your vehicle at all times. The system is designed to be an aid and does not relieve you of your responsibility to drive with due care and attention. Failure to follow this instruction could result in the loss of control of your vehicle, personal injury or death.

WARNING: Take regular rest breaks if you feel tired. Do not wait for the system to warn you.

WARNING: Certain driving styles may result in the system warning you even if you are not feeling tired.

WARNING: In cold and severe weather conditions the system may not function. Rain, snow and spray can all limit sensor performance.

WARNING: The system will not operate if the sensor cannot track the road lane markings.

WARNING: If damage occurs in the immediate area surrounding the sensor, have your vehicle checked as soon as possible.

WARNING: The system may not correctly operate if your vehicle is fitted with a suspension kit not approved by us.

WARNING: The system may not operate properly if the sensor is blocked. Keep the windshield free from obstruction.

Note: If something is blocking the camera or damaged the windshield, Driver Alert may not function.

DRIVER ALERT LIMITATIONS

Driver alert may not function correctly if:

- The sensor cannot track the road lane markings.
- Your vehicle's speed is less than approximately 40 mph (65 km/h).

Driver Alert (If Equipped)

SWITCHING DRIVER ALERT ON AND OFF

-  Press the button on the touchscreen.
- Press **Driver Assistance**.
- Switch **Driver Alert** on or off.

Note: *The system remains on or off depending on how it was last set.*

Resetting Driver Alert

You can reset the system by either:

- Switching your vehicle off and on.
- Stopping the vehicle and then opening and closing the driver door.

DRIVER ALERT INDICATORS

System Warnings

The warning system has two stages:

- A temporary warning is issued to advise you to take a rest. This message only appears for a short time.
- If you do not rest and the system continues to detect that your driving deteriorates, it issues a further warning. This remains in the instrument cluster display until you cancel it.

Note: *The system does not warn you if the vehicle speed falls below approximately 40 mph (65 km/h).*

DRIVER ALERT – TROUBLESHOOTING

DRIVER ALERT – INFORMATION MESSAGES

Message	Action
Driver Alert Warning Rest Now	Stop and rest as soon as it is safe to do so.
Driver Alert Warning Rest Suggested	Take a rest soon.

Load Carrying

LOAD CARRYING PRECAUTIONS

Keep your loaded vehicle weight within its design rating capability, with or without a trailer. Properly loading your vehicle provides maximum return of vehicle design performance. Before you load your vehicle, become familiar with the following terms for determining your vehicle's weight rating, with or without a trailer, from the vehicle's Tire and Loading Information label or Safety Compliance Certification label.



WARNING: The appropriate loading capacity of your vehicle can be limited either by volume capacity (how much space is available) or by payload capacity (how much weight the vehicle should carry). Once you have reached the maximum payload of your vehicle, do not add more cargo, even if there is space available. Overloading or improperly loading your vehicle can contribute to loss of vehicle control and vehicle rollover.



WARNING: Exceeding the Safety Compliance Certification label vehicle weight limits can adversely affect the performance and handling of your vehicle, cause vehicle damage and can result in the loss of control of your vehicle, serious personal injury or death.



WARNING: Do not use replacement tires with lower load carrying capacities than the original tires because they may lower your vehicle's GVWR and GAWR limitations. Replacement tires with a higher limit than the original tires do not increase the GVWR and GAWR limitations.



WARNING: Do not exceed the GVWR or the GAWR specified on the certification label.



WARNING: Exceeding any vehicle weight rating can adversely affect the performance and handling of your vehicle, cause vehicle damage and can result in the loss of control of your vehicle, serious personal injury or death.



WARNING: When loading the roof racks, we recommend you evenly distribute the load, as well as maintain a low center of gravity. Loaded vehicles, with higher centers of gravity, may

Load Carrying

handle differently than unloaded vehicles. Take extra precautions, such as slower speeds and increased stopping distance, when driving a heavily loaded vehicle.

The gross combined weight must never exceed the Gross Combined Weight Rating.

USING A SLIDE-IN CAMPER

We do not recommend using your pickup for carrying a slide-in camper.

LOCATING THE SAFETY COMPLIANCE CERTIFICATION LABELS

Safety Compliance Certification Label Example:

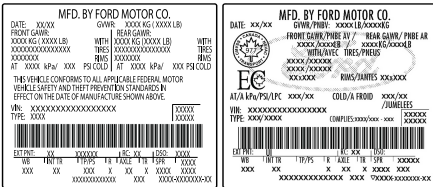

The Safety Compliance Certification label is located on the door hinge pillar, door-latch post, or the door edge that meets the door-latch post, next to the driver seating position.

WHAT IS THE GROSS AXLE WEIGHT RATING

GAWR (Gross Axle Weight Rating)

GAWR is the maximum allowable weight that a single axle (front or rear) can carry. These numbers are on the Safety Compliance Certification label.

WHAT IS THE GROSS VEHICLE WEIGHT RATING

GVWR is the maximum allowable weight of the fully loaded vehicle. This includes all options, equipment, passengers and cargo. It appears on the Safety Compliance Certification label.

WHAT IS THE GROSS COMBINED WEIGHT RATING

Gross Combined Weight Rating (GCWR) is the maximum allowable weight of the vehicle and the loaded trailer, including all cargo and passengers, that the vehicle can handle without risking damage. (Important: The towing vehicle's braking system is rated for operation at Gross Vehicle Weight Rating, not at Gross Combined Weight Rating.) Separate functional brakes should be used for safe control of towed vehicles and for trailers where the

Load Carrying

Gross Combined Weight of the towing vehicle plus the trailer exceed the Gross Vehicle Weight Rating of the towing vehicle. See **Recommended Towing Weights** (page 337).

CALCULATING PAYLOAD

Tire and Loading Label Information

Example:



TIRE AND LOADING INFORMATION

SEATING CAPACITY TOTAL: 5 FRONT: 2 REAR: 3

The combined weight of occupants and cargo should never exceed **385 kg or 850 lbs.**

TIRE	SIZE	COLD TIRE PRESSURE	SEE OWNERS MANUAL FOR ADDITIONAL INFORMATION
FRONT	235/45R18 94V	235 KPA, 34 PSI	
REAR	235/45R18 94V	235 KPA, 34 PSI	
SPARE	NONE	NONE	



TIRE AND LOADING INFORMATION RENSEIGNEMENTS SUR LES PNEUS ET LE CHARGEMENT

SEATING CAPACITY TOTAL: 5 FRONT: 2 REAR: 3
NOMBRE DE PLACES AVANT ARRIERE

The combined weight of occupants and cargo should never exceed **396 kg or 875 lbs.**
Le poids total des occupants et du chargement ne doit jamais dépasser 396 kg ou 875 lb.

TIRE PNEU	SIZE DIMENSIONS	COLD TIRE PRESSURE PRESSION DES PNEUS A FROID	SEE OWNER'S MANUAL FOR ADDITIONAL INFORMATION VOIR LE MANUEL DE L'USAGER POUR PLUS DE RENSEIGNEMENTS
FRONT AVANT	235/40R19 96V	255 KPA, 37 PSI	
REAR ARRIERE	235/40R19 96V	255 KPA, 37 PSI	
SPARE DE SECOURS	T125/80R16 97M	415 KPA, 60 PSI	

Payload is the combined weight of cargo and passengers that your vehicle is carrying. The maximum payload for your vehicle appears on the Tire and Loading label. The label is either on the B-pillar or the edge of the driver door. Vehicles

exported outside the US and Canada may not have a tire and loading label. Look for "The combined weight of occupants and cargo should never exceed XXX kg or XXX lb" for maximum payload. The payload listed on the Tire and Loading Information label is the maximum payload for your vehicle as built by the assembly plant. If you install any additional equipment on your vehicle, you must determine the new payload. Subtract the weight of the equipment from the payload listed on the Tire and Loading label. When towing, trailer tongue weight or king pin weight is also part of payload.

CALCULATING THE LOAD LIMIT

Steps for determining the correct load limit:

1. Locate the statement "The combined weight of occupants and cargo should never exceed XXX kg or XXX lb." on your vehicle's placard.
2. Determine the combined weight of the driver and passengers that will be riding in your vehicle.
3. Subtract the combined weight of the driver and passengers from XXX kg or XXX lb.

Load Carrying

4. The resulting figure equals the available amount of cargo and luggage load capacity. For example, if the “XXX” amount equals 1,400 lb. and there will be five 150 lb. passengers in your vehicle, the amount of available cargo and luggage load capacity is 650 lb. $(1400 - 750 (5 \times 150) = 650 \text{ lb.})$
5. Determine the combined weight of luggage and cargo being loaded on the vehicle. That weight may not safely exceed the available cargo and luggage load capacity calculated in Step 4.
6. If your vehicle will be towing a trailer, load from your trailer will be transferred to your vehicle. Consult this manual to determine how this reduces the available cargo and luggage load capacity of your vehicle.

Helpful examples for calculating the available amount of cargo and luggage load capacity

Suppose your vehicle has a 1400-pound (635-kilogram) cargo and luggage capacity. You decide to go golfing. Is there enough load capacity to carry you, four of your friends and all the golf bags? You and four friends average 220 pounds (99 kilograms) each and the golf bags weigh approximately 30 pounds (13.5 kilograms) each. The calculation would be: $1400 - (5 \times 220) - (5 \times 30) = 1400 - 1100$

$- 150 = 150$ pounds. Yes, you have enough load capacity in your vehicle to transport four friends and your golf bags. In metric units, the calculation would be: $635 \text{ kilograms} - (5 \times 99 \text{ kilograms}) - (5 \times 13.5 \text{ kilograms}) = 635 - 495 - 67.5 = 72.5 \text{ kilograms}$.

Suppose your vehicle has a 1400-pound (635-kilogram) cargo and luggage capacity. You and one of your friends decide to pick up cement from the local home improvement store to finish that patio you have been planning for the past two years. Measuring the inside of the vehicle with the rear seat folded down, you have room for twelve 100-pound (45-kilogram) bags of cement. Do you have enough load capacity to transport the cement to your home? If you and your friend each weigh 220 pounds (99 kilograms), the calculation would be: $1400 - (2 \times 220) - (12 \times 100) = 1400 - 440 - 1200 = -240$ pounds. No, you do not have enough cargo capacity to carry that much weight. In metric units, the calculation would be: $635 \text{ kilograms} - (2 \times 99 \text{ kilograms}) - (12 \times 45 \text{ kilograms}) = 635 - 198 - 540 = -103 \text{ kilograms}$. You will need to reduce the load weight by at least 240 pounds (104 kilograms). If you remove three 100-pound (45-kilogram) cement bags, then the load calculation would be: $1400 - (2 \times 220) - (9 \times 100) = 1400 - 440 - 900 = 60$ pounds. Now you have

Load Carrying

the load capacity to transport the cement and your friend home. In metric units, the calculation would be: 635 kilograms - (2 x 99 kilograms) - (9 x 45 kilograms) = 635 - 198 - 405 = 32 kilograms.

The above calculations also assume that the loads are positioned in your vehicle in a manner that does not overload the front or the rear gross axle weight rating specified for your vehicle on the Safety Compliance Certification label.

Pickup Bed

PICKUP BED PRECAUTIONS



WARNING: Do not allow people or animals in truck beds that have modifications, such as bed covers or slide-in campers, when the engine is running. Exhaust fumes are toxic. Failure to follow this instruction could result in personal injury or death.



WARNING: It is extremely dangerous to ride in a cargo area, inside or outside of a vehicle. In a crash, people riding in these areas are more likely to be seriously injured or killed. Do not allow people to ride in any area of your vehicle that is not equipped with seats and seatbelts. Make sure everyone in your vehicle is in a seat and properly using a seatbelt. Failure to follow this warning could result in serious personal injury or death.

the maximum payload of your vehicle, do not add more cargo, even if there is space available. Overloading or improperly loading your vehicle can contribute to loss of vehicle control and vehicle rollover.



WARNING: Do not use the load retaining fixtures for towing. Failure to follow this instruction could result in personal injury.



WARNING: Do not exceed the maximum load rating of the load retaining fixtures. Failure to follow this instruction could result in personal injury.



WARNING: Check the load retaining fixtures for damage before using them. Failure to follow this instruction could result in personal injury.

PICKUP BED ANCHOR POINTS

PICKUP BED ANCHOR POINT PRECAUTIONS



WARNING: Always properly secure cargo to prevent shifting cargo or cargo falling from the vehicle. Failure to do so could result in compromised vehicle stability and serious personal injury to vehicle occupants or others.



WARNING: The appropriate loading capacity of your vehicle can be limited either by volume capacity (how much space is available) or by payload capacity (how much weight the vehicle should carry). Once you have reached

LOCATING THE PICKUP BED ANCHOR POINTS

Pickup Bed Anchor Points

The pickup bed anchor points are in each corner of the pickup bed.

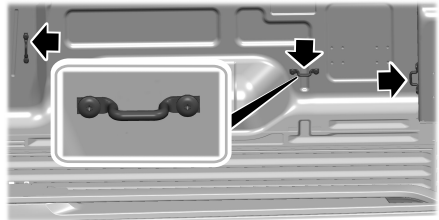

Adjustable Bed Rail (If Equipped)

Sliding cleat tie-downs are on each side of the pickup bed.

Pickup Bed

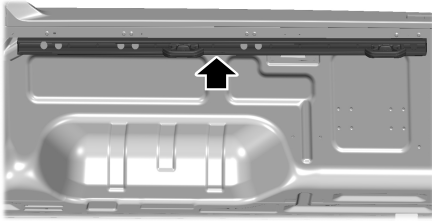

Adjusting the Sliding Cleat Tie-downs

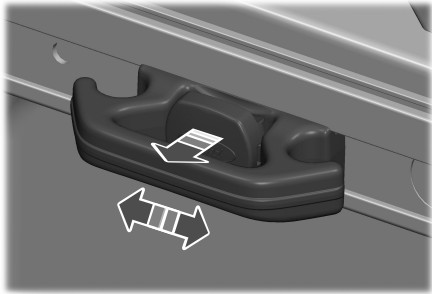

1. Pull the release button on the cleat to release the cleat.
2. Move the cleat to desired position.
3. Lock the cleat to the locking positions on the sliding rails. Locking positions can be identified as holes on the rails.

Note: The release button returns to the lock position only when the cleat is locked correctly.

Note: Do not load the cleat unless it is properly locked onto the rail.

PICKUP BED ANCHOR POINT LOAD CAPACITIES

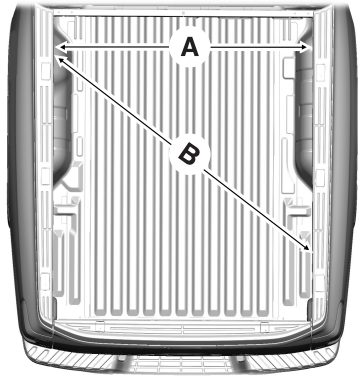

A	B
Maximum force between directly opposed anchor points 276 lb (125 kg).	Maximum force between diagonally opposed anchor points 600 lb (272 kg).

Note: You could damage the pickup bed walls if you overload the tie-downs.

Note: Make sure that you properly balance and secure the cargo load. Failure to do this can cause cargo instability and damage to the box.

Note: Do not secure cargo with tie downs connected from the tie-down brackets to the pickup box tie-downs. This could cause the tailgate to detach.

Adjustable Sliding Cleat Tie-Down Load Capacities

The sliding cleats can be used to secure loads. The maximum recommended load is 551 lb (250 kg) per cleat.

Pickup Bed

PICKUP BED SLOTS

LOCATING THE PICKUP BED SLOTS

Slots in the pickup bed provide location points for timber to support various loads.

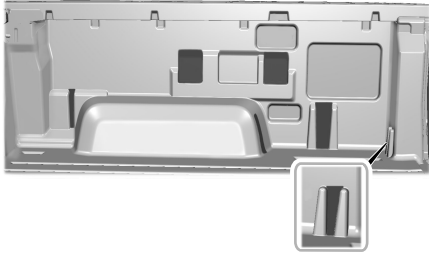

PICKUP BED ACCESS CAPS

WHAT ARE PICKUP BED ACCESS CAPS

The pickup bed has removable access caps that expose structural attachment points used to fit aftermarket accessories.

LOCATING THE PICKUP BED ACCESS CAPS

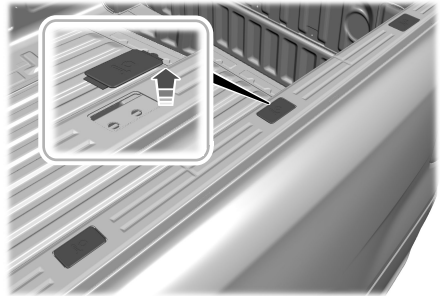

Access caps are located on the sides of the pickup bed. Remove the caps to access the attachment points.

Note: *Replace the access caps when the structural attachment points are no longer being used.*

Connecting a Trailer

CONNECTING A TRAILER PRECAUTIONS

Do not tow a trailer until you drive your vehicle at least 1,000 mi (1,600 km).

Consult your local motor vehicle laws for towing a trailer.

See the instructions included with towing accessories for the proper installation and adjustment specifications.

Service your vehicle more frequently if you tow a trailer. See **General Maintenance Information** (page 534).

If you use a rental trailer, follow the instructions the rental agency gives you.

When attaching the trailer wiring connector to your vehicle, only use a proper fitting connector that works with the vehicle and trailer functions.

Account for the trailer coupler weight as part of your vehicle load when calculating the total vehicle weight.

Do not exceed the load limits. See **Calculating the Load Limit** (page 325).

CONNECTING A TRAILER

Recognizing a Trailer

1. Attach the trailer and wiring connector to your vehicle.
2. Switch on your vehicle.
3. Set up a profile for the trailer using the touchscreen.

Note: *If your vehicle does not recognize the trailer, press and hold the brake pedal for a few seconds.*

Note: *Trailer profiles store trailer types, dimensions, preferences, trailer specific mileage and range estimation.*

Note: *Disabling the trailer detection notification makes the default trailer profile active when a connection is detected.*

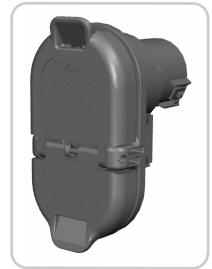
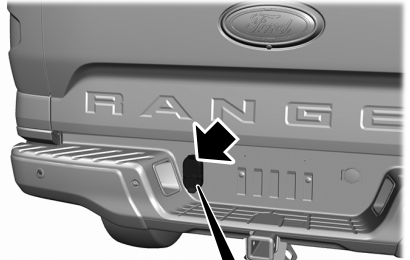

When attaching the trailer wiring connector to your vehicle, only use a proper fitting connector that works with the vehicle and trailer functions.

Safety Chains

Install trailer safety chains to the trailer hitch as recommended by the manufacturer. Cross the chains under the trailer coupler and allow enough slack for turning tight corners. Do not allow the chains to drag on the ground.

Note: *Do not attach safety chains to the bumper. Always connect the safety chains to the loops on the tow bar.*

Connecting a Trailer

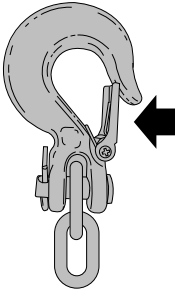

If the trailer safety chain hook has a latch, make sure the latch is fully closed.

Trailer Connection Checklist

1. Access the applications drawer on the touchscreen.
2. Press **Towing**.
3. Press **Connection Checklist**.

TRAILER LIGHTING CHECK



WARNING: Never connect any trailer lamp wiring to the vehicle's tail lamp wiring; this may damage the electrical system resulting in fire. Contact your authorized dealer as soon as possible for assistance in proper trailer tow wiring installation. Additional electrical equipment may be required.

Perform a trailer light illumination sequence to confirm that all lights are functioning by using the FordPass app or the vehicle's touchscreen.

Note: *The FordPass app allows one person to confirm that all lights are functioning.*

Performing the Trailer Lighting Check Using the Touchscreen

1.  Open the towing app using the app launcher.
2. Open the towing settings.
3. Press **Trailer Light Check**.
4. Press **Start**.

Connecting a Trailer

CONNECTING A TRAILER – TROUBLESHOOTING

CONNECTING A TRAILER – INFORMATION MESSAGES

Message	Description
Trailer Disconnected	The system senses a trailer connection becomes disconnected, either intentionally or unintentionally, during a given ignition cycle.
Trailer Wiring Fault	There are certain faults in your vehicle wiring and trailer wiring or brake system.
Trailer Battery Not Charging See Manual	There is a fault with your trailer battery, or your trailer battery voltage is very low.

Towing a Trailer

TOWING A TRAILER PRECAUTIONS

 **WARNING:** Do not exceed the GVWR or the GAWR specified on the certification label.

 **WARNING:** Towing trailers beyond the maximum recommended gross trailer weight exceeds the limit of your vehicle and could result in engine damage, transmission damage, structural damage, loss of vehicle control, vehicle rollover and personal injury.

 **WARNING:** Do not exceed the lowest rating capacity for your vehicle or trailer hitch. Overloading your vehicle or trailer hitch can impair your vehicle stability and handling. Failure to follow this instruction could result in the loss of control of your vehicle, personal injury or death.

 **WARNING:** Make sure that the vertical load on the tow ball is between the minimum and maximum recommended weight at all times. Failure to follow this instruction could result in the loss of control of your vehicle, personal injury or death.

 **WARNING:** Do not cut, drill, weld or modify the trailer hitch. Modifying the trailer hitch could reduce the hitch rating.

 **WARNING:** The anti-lock brake system does not control the trailer brakes.

Towing a trailer also depends on additional systems present in your vehicle. See **Lane Centering Precautions** (page 271).

TRAILER BRAKE PRECAUTIONS

 **WARNING:** Do not connect a trailer's hydraulic brake system directly to your vehicle's brake system. Your vehicle may not have enough braking power and your chances of having a collision greatly increase.

 **WARNING:** Do not tow a trailer fitted with electric trailer brakes unless your vehicle is fitted with a compatible aftermarket electronic trailer brake controller. Failure to follow this instruction could result in the loss of control of your vehicle, personal injury or death. For additional information and assistance, we recommend that you contact an authorized dealer.

Electric brakes and manual, automatic or surge-type trailer brakes are safe if you install them properly and adjust them to the manufacturer's specifications. The trailer brakes must meet local and federal regulations.

Towing a Trailer

The rating for the tow vehicle's braking system operation is at the gross vehicle weight rating, not the gross combined weight rating.

Certain states require functioning trailer brakes for trailers over a specified weight. Be sure to check state regulations for this specified weight.

Ford Motor Company recommends separate functioning brake systems for trailers weighing more than 1,500 lb (680 kg) when loaded.

TOWING A TRAILER LIMITATIONS

The vehicle's load capacity designation is by weight, not by volume, so you cannot necessarily use all available space when loading a vehicle or trailer.

Towing a trailer also depends on additional systems present in your vehicle. See **Lane Centering Limitations** (page 271).

Note: *Your vehicle could have reduced performance when operating at high altitudes and when heavily loaded or towing a trailer. When driving at elevation, to match driving performance as perceived at sea level, reduce gross vehicle weight and gross combination weight by 2% per 1,000 ft (300 m) of elevation.*

Note: *Do not use four-wheel drive when towing a trailer or when you heavily load your vehicle for extended periods of time.*

LOADING YOUR TRAILER

To help minimize how trailer movement affects your vehicle when driving:

- Load the heaviest items closest to the trailer floor.
- Load the heaviest items centered between the left and right side trailer tires.
- Load the heaviest items above the trailer axles or just slightly forward toward the trailer tongue. Do not allow the final trailer tongue weight to go above or below 10-15% of the loaded trailer weight. The trailer tongue weight should never exceed 10% of the maximum towing capacity.
- Select a ball mount with the correct rise or drop. When both the loaded vehicle and trailer are connected, the trailer frame should be level, or slightly angled down toward your vehicle, when viewed from the side.

TRAILER TOWING HINTS

Towing a trailer places an extra load on your vehicle's engine, transmission, axle, brakes, tires and suspension. Periodically inspect these components during and after any towing operation.

When driving with a trailer or payload, a slight takeoff vibration or shudder may be present due to the increased payload weight.

Towing a Trailer

Your vehicle may have a temporary or conventional spare tire. A temporary spare tire is different in diameter or width, tread-type, or is from a different manufacturer than the road tires on your vehicle. Consult information on the tire label or Safety Compliance label for limitations when using.

When towing a trailer:

- Obey country specific regulations for towing a trailer.
- Do not drive faster than 70 mph (113 km/h) during the first 500 mi (800 km).
- Do not make full-throttle starts.
- Check your hitch, electrical connections and trailer wheel lug nuts thoroughly after you have traveled 50 mi (80 km).
- When stopped in congested or heavy traffic during hot weather, place the transmission in park (P) to aid engine and transmission cooling and to help A/C performance.
- Turn off the speed control with heavy loads or in hilly terrain. The speed control may turn off when you are towing on long, steep slopes.
- Shift to a lower gear when driving down a long or steep hill. Do not continuously apply the brakes, as they may overheat and become less effective.
- If your transmission has Grade Assist or Tow/Haul, use this feature when towing. This provides engine braking and helps eliminate excessive transmission shifting for optimum fuel economy and transmission cooling.

- Your vehicle has AdvanceTrac with roll stability control. When towing a trailer, additional loads could cause the AdvanceTrac system to engage during cornering maneuvers. Reduce cornering speeds to make sure that you can maintain control of the vehicle and trailer if the AdvanceTrac system engages.
- Allow more distance for stopping with a trailer attached. Anticipate stops and gradually brake.
- Avoid parking on a slope. However, if you must park on a slope, turn the steering wheel to point your vehicle tires away from traffic flow, set the parking brake, place the transmission in park (P) and place wheel chocks in front and back of the trailer wheels.

Note: *Chocks are not included with your vehicle.*

LAUNCHING OR RETRIEVING A BOAT OR PERSONAL WATERCRAFT

When backing down a ramp during boat launching or retrieval:

- Do not allow the static water level to rise above the bottom edge of the rear bumper.
- Do not allow waves to break higher than 6 in (15 cm) above the bottom edge of the rear bumper.

Exceeding 6 in (15 cm) could allow water to enter vehicle components, causing internal damage to the components and affecting driveability, emissions and reliability.

Note: *Disconnect the trailer wiring connector before backing the trailer into the water.*

Towing a Trailer

Note: Reconnect the trailer wiring connector after removing the trailer from the water.

Note: Switch off Reverse Brake Assist if the trailer wiring connector is disconnected. See **Switching Reverse Brake Assist On and Off** (page 223).

TOWING WEIGHTS AND DIMENSIONS

RECOMMENDED TOWING WEIGHTS

Market	Website
United States of America	https://www.fleet.ford.com/towing-guides/
Canada	https://www.fleet.ford.ca/towing-guides/

Towing a Trailer

WHAT IS THE MAXIMUM LOADED TRAILER WEIGHT

The maximum loaded trailer weight is the highest possible weight of a fully loaded trailer the vehicle can tow.

CALCULATING THE MAXIMUM LOADED TRAILER WEIGHT FOR YOUR VEHICLE

1. Start with the gross combined weight rating for your vehicle model and axle ratio.
2. Subtract all of the following that apply to your vehicle:
 - Vehicle curb weight.
 - Hitch hardware weight, for example a draw bar, ball or locks.

- Driver weight.
- Passenger weight.
- Payload, cargo and luggage weight.
- Aftermarket equipment weight.

This equals the maximum loaded trailer weight for this combination.

Note: *The trailer tongue load is considered part of the payload for your vehicle. Reduce the total payload by the final trailer tongue weight.*

Note: *Consult an authorized dealer to determine the maximum trailer weight allowed for your vehicle if you are not sure.*

Towing a Trailer

TOWING A TRAILER – TROUBLESHOOTING

TOWING A TRAILER – INFORMATION MESSAGES

Message	Details
Trailer Left Turn Lamps Fault Check Lamps	The left-hand trailer turn lamp requires service.
Trailer Right Turn Lamps Fault Check Lamps	The right-hand trailer turn lamp requires service.
Trailer Battery Not Charging See Manual	The trailer battery voltage is too low to charge.
Trailer Lighting Module Fault See Manual	The system detects a short created by the trailer lamps. Inspect and repair the trailer wiring, or have the system checked as soon as possible.
Trailer Stop Lamps Fault Check Lamps	The trailer stoplamps require service.
Trailer Sway Reduce Speed	The trailer sway control detects trailer sway. Reduce the vehicle's speed.

Integrated Trailer Brake Controller (If Equipped)

WHAT IS THE INTEGRATED TRAILER BRAKE CONTROLLER

The trailer brake controller assists in smooth and effective trailer braking based on the towing vehicle's brake pressure.

INTEGRATED TRAILER BRAKE CONTROLLER PRECAUTIONS



WARNING: Use the integrated trailer brake controller to properly adjust the trailer brakes and check all connections before towing a trailer. Failure to follow this instruction could result in the loss of control of your vehicle, personal injury or death.

- Only use the manual control lever for proper adjustment of the gain during trailer setup. Misuse, such as application during trailer sway, could cause instability of trailer or tow vehicle.
- Avoid towing in adverse weather conditions. The trailer brake controller does not provide anti-lock control of the trailer wheels. Trailer wheels can lock up on slippery surfaces, resulting in reduced stability of trailer and tow vehicle.
- The trailer brake controller is only a factory-installed or dealer-installed item. Ford is not responsible for warranty or performance of the controller due to misuse or customer installation.

Note: Do not attempt removal of the trailer brake controller without consulting the Workshop Manual. Damage to the unit may result.

Note: Make sure to set the integrated trailer brake controller gain to 0 if you are using an aftermarket trailer brake controller.

USING THE INTEGRATED TRAILER BRAKE CONTROLLER

1. Make sure the trailer brakes are in good working condition, functioning normally and properly adjusted. See your trailer dealer if necessary.

Note: An authorized dealer can diagnose the trailer brake controller to determine exactly which trailer fault has occurred. Your vehicle warranty does not cover issues with your trailer.

2. Hook up the trailer and make the electrical connections according to the trailer manufacturer's instructions.

Note: Select default mode if the trailer has surge brakes, or no brakes at all. The system has no effect on the braking performance of the trailer in either of these cases.

Note: If a trailer is connected by a four-pin connector, the trailer braking function will not be supported.

Note: If you push the gain button in case of a trailer with mechanical brakes the instrument cluster will display, Trailer Brakes-No Trailer warning as the system does not work with those trailers.

3. When you plug in a trailer with electric or electric-over-hydraulic brakes, a message confirming connection appears in the information display.
4. Use the gain adjustment to find the desired starting point. A gain setting of 6.0 is a good starting point for heavier loads.

Note: Use the following steps to adjust the gain setting whenever road, weather and trailer, or vehicle loading conditions, change from when you initially set the gain.

Integrated Trailer Brake Controller (If Equipped)

- In a traffic-free environment, tow the trailer on a dry, level surface and squeeze the manual control lever completely.
- If the trailer wheels lock up, indicated by squealing tires, reduce the gain setting. If the trailer wheels turn freely, increase the gain setting. Repeat Steps 5 and 6 until the gain setting is at a point just below trailer wheel lock-up. If towing a heavier trailer, trailer wheel lock-up may not be attainable even with the maximum gain setting of 10.

Note: Only perform this procedure at speeds of approximately 20–25 mph (30–40 km/h).

Note: The trailer brake controller reduces output at vehicle speeds below 11 mph (18 km/h) so that trailer and vehicle braking is not jerky or harsh. This feature is only available when applying the brakes using your vehicle's brake pedal, not the controller.

Note: Your vehicle's brake system and the trailer brake system work independently of each other. Changing the gain setting on the controller does not affect the operation of your vehicle's brakes whether you attach a trailer or not.

Note: With the proper electrical connection, pressing your vehicle brake pedal or using the manual control lever illuminates both trailer and vehicle brake lamps.

Note: When you switch the engine off, the controller output is disabled and the display and module shut down. The controller module and display turn on when you switch the ignition on.

Adjusting the Trailer Brake Gain

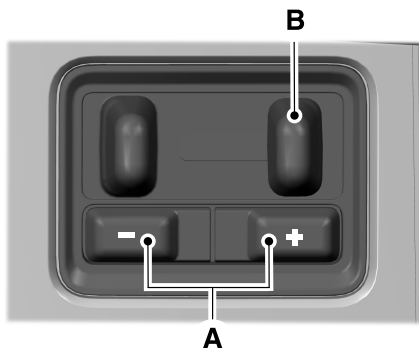

- A Increase or decrease the amount of gain in set increments.
- B Slide the control to engage the trailer brakes.

Note: Adjust the gain setting before using the trailer brake controller for the first time.

Note: The gain should be set to provide the maximum trailer braking assistance while making sure the trailer wheels do not lock when using the brakes. Locked trailer wheels may lead to trailer instability.

Note: Setting adjustments are saved when a trailer profile is selected.

ADJUSTING THE INTEGRATED TRAILER BRAKE CONTROLLER MODE

Select the correct integrated trailer brake controller mode option using the touchscreen.

Note: Trailer brake gain settings are saved to the active trailer profile.

Integrated Trailer Brake Controller (If Equipped)

Selecting the Trailer Brake Type

1. Press **Default** for trailers with electromagnetic drum brake systems or press **Electric over Hydraulic** for trailers with electrically actuated hydraulic brake systems.
2. Press **Save**.

Selecting the Trailer Brake Effort

1. Select a setting for your trailer.
Note: *The default value is **Low** and is the recommended setting for most trailers. Select a different setting if your trailer's brakes require more initial voltage, or you prefer more aggressive trailer braking.*
2. Press **Save**.

INTEGRATED TRAILER BRAKE CONTROLLER – TROUBLESHOOTING

INTEGRATED TRAILER BRAKE CONTROLLER – INFORMATION MESSAGES

Message	Details
Trailer Disconnected	The system detects the trailer wiring connection is disconnected, during a given ignition cycle.
Trailer Wiring Fault	The system detects an electrical fault in the trailer brake circuit. If this message appears without a trailer attached, see your authorized dealer. If a trailer is attached, inspect and repair the trailer wiring.
Trailer Brake Gain: {trailer gain value:#0.0}	Displays the current gain setting for the trailer brake.
Trailer Brake Gain: {trailer gain value:#0.0} No Trailer	Displays the current gain setting for the trailer brake when you do not have a trailer connected and also when you have a trailer connected with mechanical brakes.

Integrated Trailer Brake Controller (If Equipped)

INTEGRATED TRAILER BRAKE CONTROLLER – FREQUENTLY ASKED QUESTIONS

How do I determine if there is an issue with the wiring on my vehicle?

- A message displays accompanied by a single tone when no trailer is connected. This indicates the issue is between the trailer brake controller and the 7-pin connector at the bumper.

How do I determine if there is an issue with the wiring on my trailer?

- A message only displays when a trailer is connected. Consult your trailer dealer for assistance.

Trailer Sway Control

HOW DOES TRAILER SWAY CONTROL WORK

The system applies the brakes to the individual wheels and reduces engine torque to aid vehicle stability.

If the trailer begins to sway, the stability control lamp flashes and the message **Trailer Sway Reduce Speed** appears in the information display.

Stop your vehicle as soon as it is safe to do so. Check the vertical weight on the tow ball and trailer load distribution.

TRAILER SWAY CONTROL PRECAUTIONS



WARNING: Turning off trailer sway control increases the risk of loss of vehicle control, serious injury or death. Ford does not recommend disabling this feature except in situations where speed reduction may be detrimental (such as hill climbing), the driver has significant trailer towing experience, and can control trailer sway and maintain safe operation.

Note: This feature only activates when significant trailer sway occurs.

Note: This feature does not prevent trailer sway, but reduces it once it begins.

Note: This feature cannot stop all trailers from swaying.

Note: In some cases, if vehicle speed is too high, the system may activate multiple times, gradually reducing vehicle speed.

SWITCHING TRAILER SWAY CONTROL ON AND OFF

1.  Open the towing app using the app launcher.
2. Open the towing settings.
3. Switch **Trailer Sway Control** on or off.

The system turns on each time you start your vehicle.

Trailer Backup Assistance (If Equipped)

WHAT IS TRAILER BACKUP ASSISTANCE

Trailer backup assistance utilizes the control knob on the center console to help you steer a trailer. Turn the control knob in the direction you want the trailer to go and the system steers the vehicle.

HOW DOES TRAILER BACKUP ASSISTANCE WORK

Trailer backup assistance uses a sticker attached to the trailer to detect the trailer angle relative to the towing vehicle and provides instructions, graphics and camera views on the touchscreen.

Note: Trailer backup assistance only works with conventional trailers, couplers and hitch balls.

TRAILER BACKUP ASSISTANCE PRECAUTIONS



WARNING: Driving while distracted can result in loss of vehicle control, crash and injury. We strongly recommend that you use extreme caution when using any device that may take your focus off the road. Your primary responsibility is the safe operation of your vehicle. We recommend against the use of any hand-held device while driving and encourage the use of voice-operated systems when possible. Make sure you are aware of all applicable local laws that may affect the use of electronic devices while driving.



WARNING: This system is an extra driving aid. It does not replace your attention and judgment, or the need to apply the brakes. This system does NOT automatically brake your vehicle. If you fail to press the brake pedal when necessary, you may collide with another vehicle.

Note: The system restricts your vehicle speed to 3 mph (5 km/h) during operation when backing up in a straight line. The speed is reduced when backing in a curve (left or right turn).

Note: The system is not a substitute for safe driving practices. Always be aware of your vehicle and trailer combination, and the surrounding environment.

Note: The system does not detect or prevent your vehicle or trailer from making contact with obstacles in the surrounding environment.

Note: The front end of your vehicle swings out when changing the direction of the trailer.

Note: In certain conditions, the trailer could turn faster or the trailer angle could increase more than anticipated. Always monitor the clearance between the trailer and vehicle and the surroundings.

SETTING UP THE TRAILER BACKUP ASSISTANCE FOR A CONVENTIONAL TRAILER

CONFIGURING THE TRAILER

You must configure a trailer in the system to use trailer backup assistance. This is a one-time setup process and the trailer information is saved in the system for the next time you use that trailer.

Trailer Backup Assistance (If Equipped)

The following illustration shows examples of conventional trailers. Fifth wheel and gooseneck trailers are not supported.

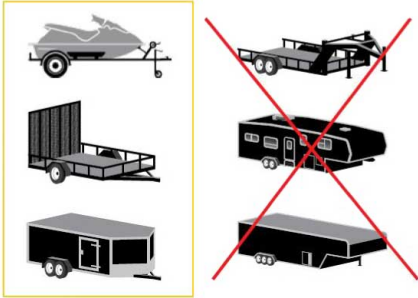

Positioning the Trailer

Hitch the trailer to your vehicle and connect the electrical wiring harness. Check to make sure that the wiring is working. See **Connecting a Trailer** (page 331).

Note: Trailer Backup Assistance continues to work if the trailer wiring harness is disconnected (for example prior to backing down a boat ramp). Reconnect the wiring as soon as possible.



Park your vehicle and hitched trailer on a level surface.

For best results, make sure that your trailer rides level with the ground when you hitch your vehicle. See **Connecting a Trailer** (page 331).



Make sure that the trailer and your vehicle are in line with each other. You can do this by putting the transmission in drive (D) and pulling straight forward.

Configuring the Trailer in the Touchscreen

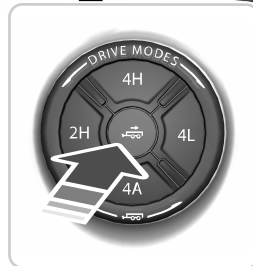
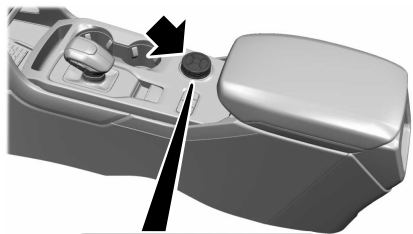

1. Press the button to switch the system on.
2. Press **Add Trailer** on the touchscreen.
3. Follow the directions on the touchscreen to enter the trailer name and trailer type, then proceed to the sticker setup.

Trailer Backup Assistance (If Equipped)

APPLYING THE TRAILER REVERSING AID STICKER

Place the sticker in an area visible by the rear view camera. The entire sticker must be within 4–20 in (10–50 cm) from the center of the hitch ball, as shown in the following illustration.

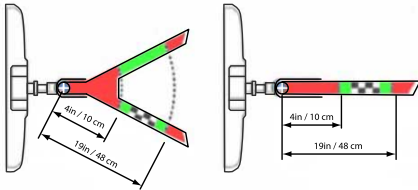

Use the supplied sticker placement card, a tape measure and pen to carefully mark the area to attach the sticker. The sticker is in the back cover pocket of your quick start guide. Make sure the entire sticker is within the green zone between the two arcs or distance markers on the diagram, and is also visible in the rear view camera display.

Once you have found the correct location, place the sticker.

Note: Make sure nothing can obstruct the rear view camera's view of the sticker such as a jack handle or wiring.

Note: Position the sticker on a flat, dry and clean horizontal surface. For best results, apply the sticker when temperatures are above 32°F (0°C).

Note: Do not move stickers after placing them. Do not re-use any stickers if removed.

Note: You can purchase additional stickers through your authorized dealer.

CALIBRATING THE SYSTEM

Calibrating the system requires driving forward and turning left or right. Follow the instructions on the touchscreen to complete the calibration process.

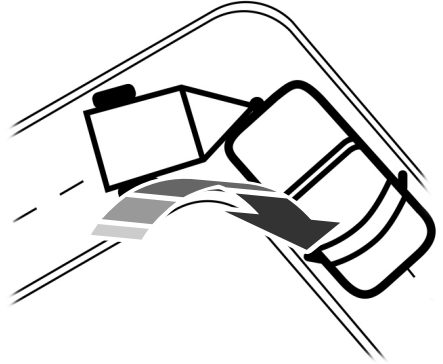

Note: To calibrate the system, you need an area where you can safely drive forward and turn left or right. An open parking lot is an ideal place to perform the calibration.

Note: You need to complete at least a 90° turn, and longer trailers could require a 180° turn. Camera trailer tracking requires the system to locate the hitch ball as well as determine the trailer length. Some trailers could require you to drive straight then turn multiple times before calibration completes. The touchscreen provides instructions and notifies you when calibration completes. Making tighter turns (when requested) helps the calibration process.

Note: Keep the steering wheel straight when instructed by the touchscreen. If the steering wheel is in a turned position during this instruction, the calibration pauses.

Trailer Backup Assistance (If Equipped)

Note: During calibration, the system determines the trailer length. The system supports trailer lengths of 6–20 ft (1.83–6.1 m) distance from the hitch point to the center of the axle or axles. The system is designed to work with drawbars (tow ball mounts) that have a license plate to hitch ball center measurement of 10–17 in (26–43 cm) when installed. Do not use drawbars or trailers that have a length outside of this range as the system performance degrades and could cause improper system function.

Note: The touchscreen shows if you are going too slow or fast. Calibration pauses if the speed is outside the required range of 2–9 mph (4–15 km/h).

Note: Do not calibrate the system at night. The calibration process may not be completed, or the system may not work as expected.

SWITCHING TRAILER BACKUP ASSISTANCE ON AND OFF

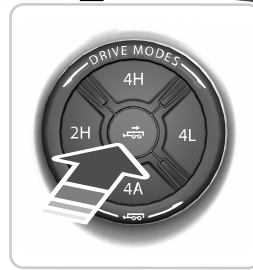
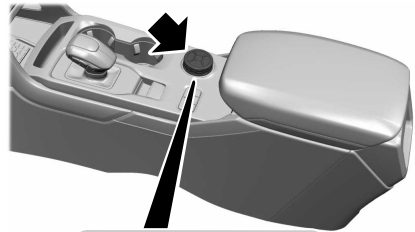

Press the button and use the touchscreen to select the connected trailer.

Note: A trailer must be configured to use trailer backup assistance. See **Configuring the Trailer** (page 345).

Note: If you use the steering wheel when using trailer backup assistance, the system turns off and a message displays in the touchscreen.

Note: If the trailer was connected just prior to turning the system on, you may need to drive forward to initialize the system. Follow the instructions on the touchscreen to activate the system.

Trailer Backup Assistance (If Equipped)

USING THE TRAILER BACKUP ASSISTANCE CONTROLLER

Use the control knob to steer the trailer. Take your hands off the steering wheel and turn the control knob instead. The control knob acts as the steering control for the trailer.

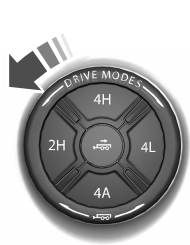

Turn and hold counterclockwise to make the trailer go left.



Turn and hold clockwise to make the trailer go right.

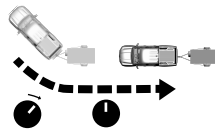

Release the knob when the trailer is moving in the direction you want.

Note: The more you turn the knob, the sharper the trailer turns.

Note: Quickly turning and releasing the knob results in a jerky movement of the vehicle.

Note: You may have to use the knob to correct the trailer direction when attempting to move the trailer straight back under some conditions.

USING THE TRAILER BACKUP ASSISTANCE VIEWS

Up to six camera views could be available when using trailer backup assistance. Use the view that helps you the most when reversing your vehicle and trailer.

Note: The rear view camera view is available on all vehicles with the trailer backup assist feature. Additional views are available on vehicles equipped with the trailer reverse guidance feature.



360° camera view. Shows a 360° view on the right-hand side of the touchscreen with a rear camera view on the left-hand side of the touchscreen.

Trailer Backup Assistance (If Equipped)



Rear view camera view. Shows your trailer hitch or what is directly behind your vehicle.



Trailer AUX camera view (if equipped). Shows a rear view camera image of what is behind your trailer.

Note: This view also provides a picture-in-picture view.



Trailer reverse guidance view. Shows you a view of the sides of your truck and the trailer. In auto mode, this view moves as the trailer moves so that you do not have to adjust the camera as you turn. Left and right arrows let you see other camera views.



Picture-in-picture view (if equipped). Shows a main view and a secondary view when in trailer AUX camera view.

Note: Picture-in-picture is on by default and cannot be switched off.



Swap. Press to swap between picture-in-picture views.



Auto

Auto. Press to return to auto view.

Note: Auto mode is the default setting.

Hitch Angle Graphic

The hitch angle graphic shows a small representation of your truck and trailer with visual feedback to help you monitor the trailer. The graphic shows two different colored lines for the trailer hitch angle. A black line shows you where your trailer is in relation to your vehicle. The white line represents the amount the trailer can turn based on knob input.

The graphic shows a yellow and red zone for the hitch angle to warn you of a high angle condition that could require you to pull forward to reduce the hitch angle. The angle limits for each zone vary based on the trailer length.

The yellow zone indicates you are approaching the maximum controllable trailer angle for the system. When the trailer enters this zone, it is more difficult to reduce the trailer turn when backing up. It may be necessary to put your vehicle into drive (D) and pull forward to get the truck and trailer back in line.

The red zone indicates you have exceeded the maximum controllable trailer angle for the system. Immediately stop reversing. Put your vehicle into drive (D) and pull forward until the trailer is no longer in the red zone.

Setting the Trailer Angle Limit

-  Press the button on the touchscreen.
-  Press **Towing**.
- Press the saved trailer you want to change.
- Press **Pro Trailer Backup Assist**.
- Press **Trailer Angle Limit**.
- Press a setting.

Normal Control Angle

Default setting. This provides a balanced limit that returns from a turn to straight backing with minimal change to the trailer direction.

Trailer Backup Assistance (If Equipped)

Max Control Angle

Increases the trailer angle limit close to the maximum controllable angle to allow

sharper turns but also causes more change in the trailer direction when straightening out from a turn.

Trailer Backup Assistance (If Equipped)

TRAILER BACKUP ASSISTANCE – TROUBLESHOOTING

TRAILER BACKUP ASSISTANCE – INFORMATION MESSAGES

Message	Description
Detecting Trailer Please Wait...	Displays when the system turns on and is initializing.
Pro Trailer Backup Assist™ System is Not Available	A condition exists that prevents the system from turning on. If the message continues to display, visit your authorized dealer to have your vehicle checked.
Pro Trailer Backup Assist™ Driving Required to Initialize Steering Press Knob to Exit	The steering system needs to learn internal parameters to fully enable the feature. Drive your vehicle straight forward above 25 mph (40 km/h) for approximately 5 minutes.
Pro Trailer Backup Assist™ Stop now Maximum trailer angle Press Knob to Exit	Displays when you reach the maximum controllable trailer angle for the system. Place your vehicle in drive (D) and pull forward to get the truck and trailer back to an in-line position. If this message consistently displays, you may need to repeat the trailer calibration. Delete the trailer from the system and repeat the setup and calibration process.
Stop now. Deactivated by trailer angle.	Displays when you exceed the maximum controllable trailer angle for the system. Place your vehicle in drive (D) and pull forward to get your vehicle and trailer back to an in-line position, then activate the system by selecting the connected trailer and following the instructions on the touchscreen. If this message consistently displays, you may need to repeat the trailer setup and calibration. Delete the trailer from the system and repeat the setup and calibration process.
Pro Trailer Backup Assist™ Stop Now Take Control of Steering Wheel	Displays when the system can no longer steer the vehicle and you must take over steering.

Trailer Backup Assistance (If Equipped)

Message	Description
Pro Trailer Backup Assist™ Trailer Not Detected. Shift to Park Press Knob to Exit	These messages display when the system does not detect the trailer.
Pro Trailer Backup Assist™ Trailer Not Detected. Refer to Owner's Manual. Press Knob to Exit	Make sure the rear camera is clean, and the sticker is clearly visible in the camera image. You can also move the trailer forward or backward to change the trailer position and lighting conditions. If these messages continue to display, visit your authorized dealer to have your vehicle checked.
Pro Trailer Backup Assist™ Trailer Not Detected Pull Forward to Initialize Press Knob to Exit	This message displays when the camera system cannot detect the trailer and requires trailer movement to enable trailer detection. Drive forward above 2 mph (3 km/h) to initialize the system.
Pro Trailer Backup Assist™ Stop Now System Not Active Press Knob to Exit	Displays when your vehicle is backing up but the system is not activated. Select the connected trailer on the touchscreen and follow the instructions to activate the system. This message also displays when you back up during the calibration process.
Pro Trailer Backup Assist™ Backup Slowly Turn Knob to Steer Press Knob to Exit	Displays when the system turns on and is available to use.

Trailer Backup Assistance (If Equipped)

TRAILER BACKUP ASSISTANCE – FREQUENTLY ASKED QUESTIONS

Why does the trailer not reverse straight?

Factors such as the hitch connection, road camber, road slope and trailer suspension could influence how straight the system can reverse the trailer when the control knob is not turned. You can compensate for the trailer drifting to the right or left by slowly turning the knob until the trailer is following your desired path and then holding the knob in that position.

What does it mean if the system remains on one message for an extended time during calibration when setting up the system with the sticker?

The camera could need to be cleaned, the sticker could be blocked, the drawbar could be outside the allowed range of 4–19 in (10–48 cm) or you could need to move to a different area to change the lighting and background. Verify the sticker is in the proper location. See **Applying the Trailer Reversing Aid Sticker** (page 347). You can move to a different area or change the direction you are driving or setup the system at a different time of day. Some trailers are not compatible with the sticker and camera system.

What does it mean if the system pauses during calibration?

There could be steering input or trailer movement during the straight drive portion of the calibration process.

What does it mean if the system displays hold steering steady during turn?

Part of the calibration process for the sticker setup requires a steady turn. If you are continually moving the steering wheel during the turn, this delays the calibration process. To enable the calibration process, hold the steering wheel at the same position when turning.

What does it mean if the system displays that it is not available?

There could be a sub-system that the system uses that is not correctly operating or there could be a battery voltage issue. If the system continues to display it is not available, visit your authorized dealer to have your vehicle checked.

What does it mean if the system displays that driving is required to initialize steering?

The steering system needs to learn internal parameters to fully turn on the feature. Drive your vehicle straight forward above 25 mph (40 km/h) for approximately 5 minutes. This could also occur when your vehicle is new, there is a battery voltage issue or if the steering system has been serviced.

What does it mean if the system requires you to pull forward to initialize?

This occurs when the vehicle has not moved during the current key cycle after you connect and select the trailer in the touchscreen or you operate the system at speeds below 1 mph (1 km/h) for an extended period of time. Drive forward above 2 mph (3 km/h) and the system indicates when it initializes.

Trailer Backup Assistance (If Equipped)

What does it mean if the trailer is at its maximum angle or the system deactivated by trailer angle?

You are at the maximum controllable trailer angle for the system. Place your vehicle in drive (D) and pull forward to get the truck and trailer back to an in-line position. If this message consistently displays, this could indicate the sticker is incorrectly placed, the trailer needs to be recalibrated or the drawbar or the trailer dimensions are outside of the supported range. The system is designed to work with drawbars that have a license plate to hitch ball center measurement of 9–18 in (23–46 cm) when installed. The system is designed to work with trailers that have a hitch point to center of the axle or axles measurement of 6–33 ft (1.85–10.05 m). Do not attempt to use drawbars or trailers that have a length outside of this range as the system performance degrades and could cause improper system function. Check that the correct trailer is selected in the touchscreen. Verify the sticker is placed according to the instructions. Then, delete the trailer from the system and repeat the setup process to calibrate the trailer.

What does it mean when the system tells you to take control of the steering wheel?

The system is no longer steering the vehicle and you must take over steering. There are four reasons the system could display this message:

1. You have touched the steering wheel when the system is steering. Avoid touching the wheel during system operation.
2. You have exceeded the maximum speed of 24.9 mph (40 km/h) for the feature.

3. The system no longer detects the trailer.
4. An internal condition for system operation is not met that requires your vehicle to return to manual control of the steering.

What does it mean if the system does not detect a trailer that is setup with a sticker?

The system requires a clear view of the sticker placed on the trailer. You must keep the camera lens and sticker clean for the system to correctly operate. If the system cannot initially detect the trailer, it could be necessary for you to change the lighting conditions by moving your vehicle and trailer or waiting until the conditions change. See **Applying the Trailer Reversing Aid Sticker** (page 347). Some trailers are not compatible with the sticker and camera system.

Trailer Reverse Guidance (If Equipped)

WHAT IS TRAILER REVERSE GUIDANCE

Trailer reverse guidance provides views and graphics on the touchscreen to help you steer your vehicle when you backup a trailer.

HOW DOES TRAILER REVERSE GUIDANCE WORK

Trailer reverse guidance uses a sticker attached to the trailer to detect the trailer angle relative to the towing vehicle and provides instructions, graphics and camera views on the touchscreen.

Note: Trailer reverse guidance only works with conventional trailers and couplers and on cars with a 360 degree camera system.

TRAILER REVERSE GUIDANCE PRECAUTIONS



WARNING: Driving while distracted can result in loss of vehicle control, crash and injury. We strongly recommend that you use extreme caution when using any device that may take your focus off the road. Your primary responsibility is the safe operation of your vehicle. We recommend against the use of any hand-held device while driving and encourage the use of voice-operated systems when possible. Make sure you are aware of all applicable local laws that may affect the use of electronic devices while driving.



WARNING: This system is an extra driving aid. It does not replace your attention and judgment, or the need to apply the brakes. This system does NOT automatically brake your vehicle. If you fail to press the brake pedal when necessary, you may collide with another vehicle.

Note: The system is not a substitute for safe driving practices. Always be aware of your vehicle and trailer combination, and the surrounding environment.

Note: The system does not detect or prevent your vehicle or trailer from making contact with obstacles in the surrounding environment.

Note: The front end of your vehicle swings out when changing the direction of the trailer.

Note: In certain conditions, the trailer could turn faster or the trailer angle could increase more than anticipated. Always monitor the clearance between the trailer and vehicle and the surroundings.

SETTING UP TRAILER REVERSE GUIDANCE FOR A CONVENTIONAL TRAILER

CONFIGURING THE TRAILER

You must configure a trailer in the system to use trailer reverse guidance. This is a one-time setup process and the trailer information is saved in the system for the next time you use that trailer.

The system only works with conventional trailers. It does not work with other types including fifth-wheel and gooseneck. The following illustration shows examples of conventional trailers on the left-hand side.

Trailer Reverse Guidance (If Equipped)

Note: Trailer reverse guidance camera views are available with no trailer setup. However, complete functionality including graphics and automatic view switching is enabled by setup. Setup is required to enable trailer backup assistance.

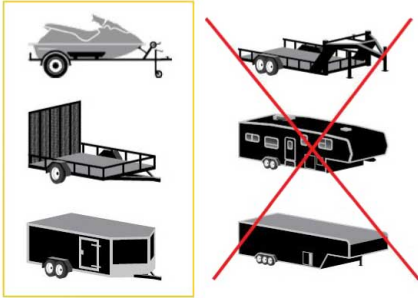

Positioning the Trailer

Hitch the trailer to your vehicle and connect the electrical wiring harness. Check to make sure that the wiring is working. See **Connecting a Trailer** (page 331).



Park your vehicle and hitched trailer on a level surface.

For best results, make sure that your trailer rides level with the ground when you hitch your vehicle. See **Connecting a Trailer** (page 331).



Make sure that the trailer and your vehicle are in line with each other. You can do this by putting the transmission in drive (D) and pulling straight forward.

Configuring the Trailer in the Touchscreen

1. Shift to reverse (R).
2. Press the camera menu view button.
3. Press the trailer view icon.
4. Press **Add Trailer**.
5. Follow the directions on the touchscreen to enter the trailer name and trailer type, then proceed to the sticker setup.

APPLYING THE TRAILER REVERSE AID STICKER

Place the sticker in an area visible by the rear view camera. The entire sticker must be within 4–19 in (10–48 cm) from the center of the hitch ball, as shown in the following illustration.

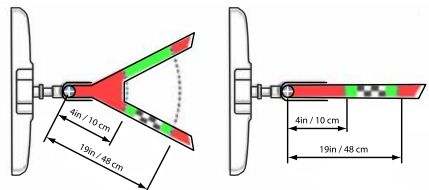

Trailer Reverse Guidance (If Equipped)

Use the supplied sticker placement card, a tape measure and pen to carefully mark the area to attach the sticker. The sticker is in the back cover pocket of your quick start guide. Make sure the entire sticker is within the green zone between the two arcs or distance markers on the diagram, and is also visible in the rear view camera display.

Once you have found the correct location, place the sticker.

Note: Make sure nothing can obstruct the rear view camera's view of the sticker such as a jack handle or wiring.

Note: Position the sticker on a flat, dry and clean horizontal surface. For best results, apply the sticker when temperatures are above 32°F (0°C).

Note: Do not move stickers after placing them. Do not re-use any stickers if removed.

Note: You can purchase additional stickers through your authorized dealer.

CALIBRATING THE SYSTEM

Calibrating the system requires driving forward and turning left or right. Follow the instructions on the touchscreen to complete the calibration process.

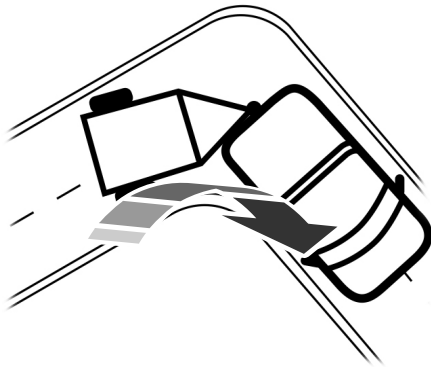

Note: To calibrate the system, you need an area where you can safely drive forward and turn left or right. An open parking lot is an ideal place to perform the calibration.

Note: Keep the steering wheel straight when instructed to by the touchscreen. If the steering wheel is in a turned position during this instruction, the calibration pauses.

Note: During calibration, the system determines the trailer length. The system supports trailer lengths of 6–20 ft (1.83–6.1 m) distance from the hitch point to the center of the axle or axles. The system is designed to work with drawbars (tow ball mounts) that have a license plate to hitch ball center measurement of 10–17 in (26–43 cm) when installed. Do not use drawbars or trailers that have a length outside of this range as the system performance degrades and could cause improper system function.

Note: The touchscreen shows if you are going too slow or fast. Calibration pauses if the speed is outside the required range of 2–9 mph (4–15 km/h).

Note: You need to complete at least a 90° turn, and longer trailers could require a 180° turn. Camera trailer tracking requires the system to locate the hitch ball as well as determine the trailer length. Some trailers could require you to drive straight then turn multiple times before calibration completes. The touchscreen provides instructions and notifies you when calibration completes.

Note: Do not calibrate the system at night. The calibration process may not be completed, or the system may not work as expected.

Trailer Reverse Guidance (If Equipped)

SWITCHING TRAILER REVERSE GUIDANCE ON AND OFF

Shift into reverse (R), press the rear camera menu view button to expand the menu, press the trailer icon and use the touchscreen to select the connected trailer.

Note: If the trailer was connected just prior to turning the system on, you may need to drive forward to initialize the system. Follow the instructions on the touchscreen to activate the system.

USING TRAILER REVERSE GUIDANCE VIEWS

Up to six camera views could be available when using trailer reverse guidance. Use the view that helps you the most when reversing your vehicle and trailer.



360° camera view. Shows a 360° view on the right-hand side of the touchscreen with a rear camera view on the left-hand side of the touchscreen.



Rear view camera view. Shows your trailer hitch or what is directly behind your vehicle.



Trailer AUX camera view. (Where Fitted) Shows a rear view camera image of what is behind your trailer.

Note: This view also provides a picture-in-picture view.



Trailer reverse guidance view. Shows you a view of the sides of your truck and the trailer. In auto mode, this view moves as the trailer moves so that you do not have to adjust the camera as you turn. Left and right arrows let you see other camera views.



Straight backup mode. Shows which way to turn your steering wheel to keep the trailer straight.

Use this view when you want to keep your trailer completely in line with your truck.

Note: This view also provides a picture-in-picture view.

Note: It may be helpful to shift your vehicle into drive (D), pull forward and straighten out the vehicle and trailer before engaging straight backup mode.



Picture-in-picture view. Shows a main view and a secondary view when in trailer AUX camera view. (Where Fitted)

Note: Picture-in-picture is on by default (where fitted) and cannot be switched off.



Swap. Press to swap between picture-in-picture views.



This takes you back to the 360° camera system and out of the trailer reverse guidance feature.



Auto. Press to return to auto view.

Note: Auto mode is the default setting.

Hitch Angle Graphic

The hitch angle graphic shows a small representation of your truck and trailer with visual feedback to help you monitor the trailer. The graphic shows two different colored lines for the trailer hitch angle. A black line shows you where your trailer is in relation to your vehicle. The white line represents the amount the trailer can turn based on steering wheel position.

The graphic shows a yellow and red zone for the hitch angle to warn you of a high angle condition that could require you to pull forward to reduce the hitch angle. The angle limits for each zone vary based on the trailer length.

Trailer Reverse Guidance (If Equipped)

The yellow zone indicates you are approaching the maximum controllable trailer angle for the system. When the trailer enters this zone, it is more difficult to reduce the trailer turn when backing up. It may be necessary to put your vehicle back into drive (D) and pull forward to get the truck and trailer back to an in-line

position.

The red zone indicates you have exceeded the maximum controllable trailer angle for the system. Immediately stop reversing. Put your vehicle into drive (D) and pull forward until the trailer is no longer in the red zone.

Trailer Reverse Guidance (If Equipped)

TRAILER REVERSE GUIDANCE – TROUBLESHOOTING

TRAILER REVERSE GUIDANCE – INFORMATION MESSAGES

Message	Description
Detecting Trailer Please Wait...	Displays when the system turns on and is initializing.
Trailer Reverse Guidance System is Not Available	A condition exists that prevents the system from turning on. If the message continues to display, visit your authorized dealer to have your vehicle checked.
Trailer Reverse Guidance Driving Required to Initialize Steering Press OK to Exit	The steering system needs to learn internal parameters to fully enable the feature. Drive your vehicle straight forward above 25 mph (40 km/h) for approximately 5 minutes.
Stop now. Deactivated by trailer angle.	Displays when you exceed the maximum controllable trailer angle for the system. Place your vehicle in drive (D) and pull forward to get your vehicle and trailer back to an in-line position, then activate the system by selecting the connected trailer and following the instructions on the touchscreen. If this message consistently displays, you may need to repeat the trailer setup and calibration. Delete the trailer from the system and repeat the setup and calibration process.
Trailer Reverse Guidance Trailer Not Detected. Refer to Owner's Manual. Press OK to Exit	Displays when the system does not detect the trailer. Make sure the rear camera is clean, and the sticker is clearly visible in the camera image. You can also move the trailer forward or backward to change the trailer position and lighting conditions. If this message continues to display, visit your authorized dealer to have your vehicle checked.

Trailer Reverse Guidance (If Equipped)

Message	Description
Trailer Reverse Guidance Trailer Not Detected Pull Forward to Initialize Press OK to Exit	This message displays when the camera system cannot detect the trailer and requires trailer movement to enable trailer detection. Drive forward above 2 mph (3 km/h) to initialize the system.

Trailer Reverse Guidance (If Equipped)

TRAILER REVERSE GUIDANCE – FREQUENTLY ASKED QUESTIONS

Why does the trailer not reverse straight?

Verify the sticker has been positioned correctly. Other factors such as the hitch connection, road camber, road slope and trailer suspension could influence how straight the system can reverse the trailer when the control knob is not turned. You can compensate for the trailer drifting to the right or left by slowly turning the knob until the trailer is following your desired path and then holding the knob in that position.

What does it mean if the system remains on one message for an extended time during calibration when setting up the system with the sticker?

The camera could need to be cleaned, the sticker could be blocked, the drawbar could be outside the allowed range of 4–19 in (10–48 cm) or you could need to move to a different area to change the lighting and background. Verify the sticker is in the proper location. See **Applying the Trailer Reverse Aid Sticker** (page 357). You can move to a different area or change the direction you are driving or set up the system at a different time of day. Some trailers are not compatible with the sticker and camera system.

What does it mean if the system pauses during calibration?

There could be steering input or trailer movement during the straight drive portion of the calibration process.

What does it mean if the system displays hold steering steady during turn?

Part of the calibration process for the sticker setup requires a steady turn. If you are continually moving the steering wheel during the turn, this delays the calibration process. To enable the calibration process, hold the steering wheel at the same position when turning.

What does it mean if the system displays that it is not available?

There could be a sub-system that the system uses that is not correctly operating or there could be a battery voltage issue. If the system continues to display it is not available, visit your authorized dealer to have your vehicle checked.

What does it mean if the system displays that driving is required to initialize steering?

The steering system needs to learn internal parameters to fully turn on the feature. Drive your vehicle straight forward above 25 mph (40 km/h) for approximately 5 minutes. This could also occur when your vehicle is new, there is a battery voltage issue or if the steering system has been serviced.

What does it mean if the system requires you to pull forward to initialize?

This occurs when the vehicle has not moved during the current key cycle after you connect and select the trailer in the touchscreen or you operate the system at speeds below 1 mph (1 km/h) for an extended period of time. Drive forward above 2 mph (3 km/h) and the system indicates when it initializes.

Trailer Reverse Guidance (If Equipped)

What does it mean if the trailer is at its maximum angle or the system deactivated by trailer angle?

You are at the maximum controllable trailer angle for the system. Place your vehicle in drive (D) and pull forward to get the truck and trailer back to an in-line position. If this message consistently displays, this could indicate the sticker is incorrectly placed, the trailer needs to be recalibrated or the drawbar or the trailer dimensions are outside of the supported range. The system is designed to work with drawbars that have a license plate to hitch ball center measurement of 10–17 in (26–43 cm) when installed. The system is designed to work with trailers that have a hitch point to center of the axle or axles measurement of 6–20 ft (1.83–6.1 m). Do not use drawbars or trailers that have a length outside of this range as the system performance degrades and could cause improper system function. Check that the correct trailer is selected in the touchscreen. Verify the sticker is placed according to the instructions. Then, delete the trailer from the system and repeat the setup process to calibrate the trailer.

What does it mean if the system does not detect a trailer that is setup with a sticker?

The system requires a clear view of the sticker placed on the trailer. You must keep the camera lens and sticker clean for the system to correctly operate. If the system cannot initially detect the trailer, it could be necessary for you to change the lighting conditions by moving your vehicle and trailer or waiting until the conditions change. See **Applying the Trailer Reverse Aid Sticker** (page 357). Some trailers are not compatible with the sticker and camera system.

Note: *The system is designed to be used with the same trailer connection every time you choose the trailer from the touchscreen. When using a different drawbar (tow ball mount) or a different pin hole on drawbars with more than one, connecting the drawbar to your vehicle affects the trailer position and you may need to repeat the trailer setup and calibration process.*

Off-Road Driving

BASIC OFF-ROAD DRIVING TECHNIQUES

Off-road Driving Hints

Before taking your vehicle off-roading, perform a basic inspection to make sure your vehicle is in good working condition.

We recommend that you always use at least two vehicles while off-roading. The buddy system helps make sure that help is close at hand should a vehicle become stuck or damaged. It is also wise to take supplies such as a first aid kit, water, tow strap, cell phone with you.

The following are hints for safe off-road driving:

- Steer, brake and accelerate in a smooth controlled manner. Avoid jerky, unsteady movements.
- Look ahead on your route noting upcoming obstacles, or any other factors that may indicate a change in available traction and adjust the vehicle speed and route accordingly.
- If the front or rear suspension is bottoming out, or you encounter excessive contact with the skid-plates, reduce the vehicle speed to avoid potential damage to your vehicle.
- We recommend that you use vehicle communication, such as, turn signals, brake lights, and hazard flashers to alert other drivers of what you intend to do next, and of obstacles that could cause potential vehicle damage.

- Always keep available ground clearance in mind and pick a route that minimizes the risk of catching the underside of the vehicle on an obstacle.
- When negotiating low speed obstacles, applying light brake pressure in conjunction with the throttle helps prevent your vehicle from jerking and allows you to negotiate the obstacle in a more controlled manner. Using four-wheel drive low (4L) will also help with this.

Crossing Obstacles

- Review the path ahead before attempting to cross an obstacle. It is best if you view the obstacle from outside your vehicle so that you have a good understanding of terrain conditions both in front of and behind the obstacle.
- Approach obstacles slowly.
- If you cannot avoid a large obstacle such as a rock, choose a path that places the rock directly under the tire rather than the undercarriage of your vehicle. This helps prevent damage to your vehicle.
- Cross ditches and washouts at a 45° angle, allowing each wheel to independently cross the obstacle.

Climbing A Hill



WARNING: Extreme care should be used when steering the vehicle in reverse down a slope so as not to cause the vehicle to swerve out of control.

Do not drive over the crest of a hill without seeing what conditions are on the other side. Do not drive in reverse over a hill without the aid of an observer.

Off-Road Driving

- Always attempt to climb a steep hill along the fall line of the slope and not diagonally.
- If the vehicle is unable to make it up the hill, DO NOT attempt to turn back down the slope. Place the vehicle in low range and slowly back down in reverse.
- When descending a steep slope, select low gear and engage hill descent control. Use the accelerator and brake pedals to control your descent speed.

Note: Hill descent control is functional in reverse and should be used in this situation.

Note: Avoid turning on steep slopes or hills. You could lose traction, slip sideways or a possible vehicle roll over.

Driving Over Rocks and Gravel

Never attempt to straddle a rock that is large enough to strike your axles or undercarriage. Leave a generous gap between your vehicle and other vehicles to minimize the risk of damage. Avoid dust clouds as they reduce visibility.

DRIVING YOUR VEHICLE AT HIGH SPEEDS

If you plan on using your vehicle for severe, high speed off-road use, we recommend the following:

- Equipping your vehicle with the safety equipment appropriate for off-road recovery.
- Using personal safety equipment, including a certified helmet and approved neck restraint device.
- Doing a low speed observance run in unfamiliar areas to become aware of any obstacles that you could encounter.

The vehicle warranty does not cover damage caused by driving your vehicle beyond its capabilities, or in extreme off-road conditions. Damage can include but is not limited to the following: skid plates, shock guards, running boards and exterior finishes, as well as a bent, cracked or broken body, frame and chassis components.

Note: Driving your vehicle off-road at high speeds will require an alternative maintenance schedule.

DRIVING THROUGH WATER LIMITATIONS



WARNING: Do not attempt to cross a deep, fast flowing body of water. Failure to follow this instruction could result in the loss of control of your vehicle, personal injury or death.

Determine the depth and speed of the current before attempting a water crossing. As the water depth increases, reduce your vehicle speed to avoid potential vehicle damage.

The key to a safe crossing is the water depth, current and bottom of the water's condition. On soft bottoms, the vehicle sinks in, effectively increasing the water level on the vehicle. Make sure to consider this when determining the depth of water. Be aware that obstacles and debris may be beneath the water's surface.

Note: Cross flowing water at an angle heading slightly upstream.

Note: Tread lightly and avoid damage to the environment.

Off-Road Driving

Drive slowly when crossing water. Start very slowly when entering, then build momentum. Proceed with a constant slow speed lightly pressing on the accelerator. Ease off the accelerator as you reach the other side to diminish the front wave. Apply the accelerator slowly and as necessary to climb out of the other side.

Note: Do not try to accelerate through the water crossing.

When driving too fast in water or through deep water, the engine, transmission, transfer case, axles, electrical components or vehicle interior could ingest water. Muddy waters can reduce the cooling system effectiveness by depositing debris into the radiator. The vehicle warranty does not cover water damage. See below for your vehicle's capabilities.

Model	Maximum Wading Capability
Vehicles without Tremor or XL Off-Road Packages	22 in (560 mm) ¹
XL Off-Road Package	30 in (762 mm)
Tremor Package	33 in (838 mm)

¹ Bottom of the doors.

Note: When you are driving through water do not exceed 4.3 mph (7 km/h)

Never stop or shut a vehicle off when crossing deep water unless your vehicle ingested water into the engine air intake. If the engine stalls, do not attempt to restart it. Keep the doors fully closed during a water crossing. Take extra care crossing any type of water. Do not drive into water unless necessary. Only drive through areas that are designated and approved.

Determine exit points that are downstream of your entry point to allow for drifting. If there are other vehicles ahead, wait until they have left the water. Unsettled water can make a safe passage more challenging.

High currents even in shallow water can wash the dirt out from around your tires or push your vehicle across slippery rocks or surfaces. Never attempt to cross flowing water that is deeper than your vehicle's ground clearance. Even in low currents your vehicle's body surface area can be pushed downstream and out of control. Do not cross any body of water that is fast flowing and rising, wait for the flow rate to reduce.

Vehicles used to cross water regularly should be periodically inspected for signs of water ingestion in all of the vehicle's fluids. If water is found inside your vehicle fluids, service your vehicle or see an authorized dealer.

After driving through water and as soon as it is safe to do so, check the brakes, horn, lights, and steering wheel to make sure everything is still in working order.

WATER WADING - EXCLUDING: RAPTOR



WARNING: Do not attempt to cross a deep, fast flowing body of water. Failure to follow this instruction could result in the loss of control of your vehicle, personal injury or death.

As the water depth increases, you must reduce your vehicle speed to avoid potential vehicle damage.

Off-Road Driving



As the water depth increases, you must reduce your vehicle speed to avoid potential vehicle damage.



- Always determine the depth before attempting a water crossing. Never drive through water that is higher than the bottom of the wheel hubs.
- Slowly proceed and avoid splashing water any more than is necessary.
- Be aware that obstacles and debris may be beneath the water's surface.
- Keep the doors fully closed during the water crossing.
- After driving through water and as soon as it is safe to do so, check the brakes, horn, lights, and steering wheel to confirm those systems are properly functioning.

Note: Engine damage can occur if water enters the air filter.

- Always determine the depth before attempting a water crossing.
- Slowly proceed and avoid splashing water any more than is necessary.
- Be aware that obstacles and debris may be beneath the water's surface.
- Keep the doors fully closed during the water crossing.
- After driving through water and as soon as it is safe to do so, check the brakes, horn, lights, and steering wheel to confirm those systems are properly functioning.

Note: Engine damage can occur if water enters the air filter.

WATER WADING - RAPTOR



WARNING: Do not attempt to cross a deep, fast flowing body of water. Failure to follow this instruction could result in the loss of control of your vehicle, personal injury or death.

OFF-ROAD DRIVING AIDS

Selecting an Off-Road Drive Mode

Using the appropriate drive mode increases your vehicle's control. See **Drive Mode Control** (page 282).

Off-Road Driving

Using Four-Wheel Drive

Your vehicle has a four-wheel drive system that offers various modes to help you optimize traction on any off-road surface. See **Four-Wheel Drive** (page 199).

Using the Cameras Off-Road

Use the 360 degree camera to enhance your off-road experience. See **360 Degree Camera** (page 251).

Using the Rear Differential Lock

When engaged, the rear differential lock provides additional traction to your vehicle by forcing the two rear wheels to turn at the same speed.

Note: *Rear differential lock is only available when the vehicle is in four-wheel drive high (4H) or four-wheel drive low (4L). See **Electronic Locking Differential** (page 208).*

Using Trail Control

Trail Control provides you the ability to maneuver the vehicle without using the throttle and brake pedals.

The system controls acceleration and braking in difficult off-road environments, which allows you to focus on steering. See **Trail Control** (page 235).

Trail Control Performance:

- Manages wheel slip to maximize traction.
- Provides braking to maximize traction in descents.

Using Trail One Pedal Drive (if

Equipped)

Trail one pedal drive allows you to accelerate and brake using only the accelerator pedal.

Use this when driving over large obstacles, such as rocks or logs, to help maintain a constant vehicle speed.

In four-wheel drive high (4H), the system offers lift pedal braking and auto hill hold functionality.

Note: *Trail one pedal drive is only available when the vehicle is in four-wheel drive high (4H) or four-wheel drive low (4L).*

AFTER DRIVING YOUR VEHICLE OFF-ROAD



WARNING: After off-road use, before returning to the road, check the wheels and tires for damage. Off-road use may cause damage to your wheels and tires that can lead to tire failure, loss of vehicle control, serious injury or death.



WARNING: Always re-inflate tires to recommended tire pressures before the vehicle is operated on-road. The recommended pressure is located on the tire label or safety certification label, located on the B-pillar, inside the driver's door.

After driving off-road check for damage to your vehicle and, if necessary, have your vehicle fixed as soon as possible. Inspect the underbody of your vehicle by checking tires, body structure, steering, suspension, and exhaust system for damage.

Check the radiator for mud and debris and clean as needed.

Remove accumulations of plants or brush. These things could be a fire hazard or hide damage to the fuel lines, brake hoses, and propeller shafts.

Off-Road Driving

With the vehicle off, use a low pressure hose to wash away mud and fine debris. You may need to reach past the active grille shutters to remove larger debris.

If you experience unusual vibration after driving in mud, slush or similar conditions, check the wheels for impacted material. Impacted material can cause vibrations while driving and wheel imbalance. Remove the material to resolve the problem.

OFF-ROAD SCREEN

WHAT IS THE OFF-ROAD SCREEN

The off-road screen displays information related to the vehicle's position and performance. It is designed to help you get the most out of your vehicle's off-road driving capabilities.

HOW DOES THE OFF-ROAD SCREEN WORK

The off-road screen assists you by:

- Using the cameras to display what is directly in front of and behind your vehicle to help you avoid obstacles.
- Displaying information related to tire pressure if the vehicle is equipped with the tire pressure monitoring system.
- Displaying information related to drivetrain status.
- Allowing you to enable or disable a variety of on-demand features.

SWITCHING THE OFF-ROAD SCREEN ON AND OFF



Press and release the off-road switch to enable the feature, press and release the switch again to disable.

The off-road screen can also be enabled and disabled through the touchscreen:

1.  Press the button on the touchscreen.
2. Press **CONTROLS**.
3. Press **Off-Road**.

USING THE OFF-ROAD SCREEN - VEHICLES WITH: 360 DEGREE CAMERA, EXCLUDING: RAPTOR

The buttons on the side of the off-road screen allow you to turn the different features on and off.

Off-Road Driving



- A Off-Road camera views.
- B Exit off-road screen.
- C Information menu.
- D Off-road feature buttons.
- E Active guidelines.

Off-Road Feature Buttons

These buttons activate various off-road features. The features available depend on your vehicle's equipment.



Trail control. See **Trail Control** (page 235).



Front differential lock. See **Electronic Locking Differential** (page 208).



Rear differential lock. See **Electronic Locking Differential** (page 208).



Parking aids. See **Parking Aids** (page 243).

Off-Road Information On-Demand



Off-road status.



Pitch and roll.



Parking aid indicators. See **Parking Aid Indicators** (page 247).

Off-Road Camera (if Equipped)

The off-road camera provides a video image of the area in the front or rear of your vehicle. For available camera views, See **Switching the 360 Degree Camera View** (page 253).

Note: The camera feed may not automatically launch with the off-road screen. If this occurs, use the camera button to re-launch the camera feed. See **Switching the 360 Degree Camera On and Off** (page 253).

USING THE OFF-ROAD SCREEN - VEHICLES WITH: ANALOG REAR VIEW CAMERA/DIGITAL REAR VIEW CAMERA, EXCLUDING: RAPTOR

The buttons on the side of the off-road screen allow you to turn the different features on and off.

Off-Road Driving

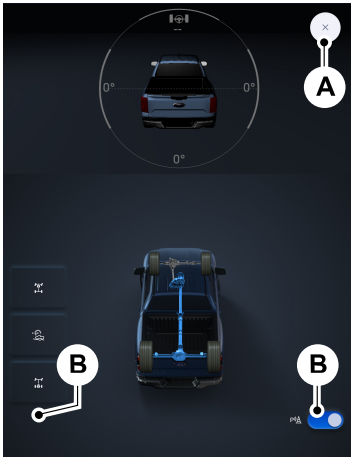

- A Exit off-road screen.
- B Off-road feature buttons.

Off-Road Feature Buttons

These buttons activate various off-road features. The features available depend on your vehicle's equipment.



Trail control. See **Trail Control** (page 235).



Front differential lock. See **Electronic Locking Differential** (page 208).



Rear differential lock. See **Electronic Locking Differential** (page 208).



Parking aids. See **Parking Aids** (page 243).

USING THE OFF-ROAD SCREEN - RAPTOR, VEHICLES WITH: 360 DEGREE CAMERA

The buttons on the side of the off-road screen allow you to turn the different features on and off.

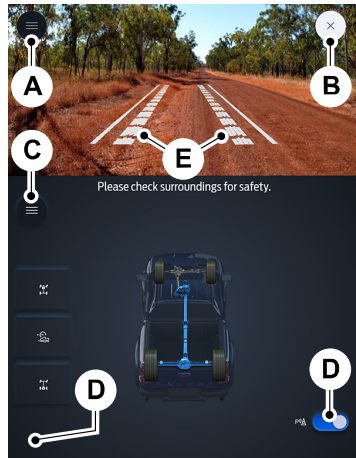

- A Off-Road camera views.
- B Exit off-road screen.
- C Information menu.
- D Off-road feature buttons.
- E Active guidelines.

Off-Road Feature Buttons

These buttons activate various off-road features. The features available depend on your vehicle's equipment.



Trail control. See **Trail Control** (page 235).



Front differential lock. See **Electronic Locking Differential** (page 208).

Off-Road Driving



Rear differential lock. See **Electronic Locking Differential** (page 208).



Parking aids. See **Parking Aids** (page 243).

Off-Road Information On-Demand



Off-road status.



Pitch and roll.



Parking aid indicators. See **Parking Aid Indicators** (page 247).

Off-Road Camera (If Equipped)

The off-road camera provides a video image of the area in the front or rear of your vehicle. For available camera views, See **Switching the 360 Degree Camera View** (page 253).

Note: *The camera feed may not automatically launch with the off-road screen. If this occurs, use the camera button to re-launch the camera feed. See **Switching the 360 Degree Camera On and Off** (page 253).*

Driving Hints

BREAKING-IN

You need to break in new tires for approximately 300 mi (480 km). During this time, your vehicle may exhibit some unusual driving characteristics.

Avoid driving too fast during the first 1,000 mi (1,600 km). Vary your speed frequently and change up through the gears early. Do not labor the engine.

Do not tow during the first 1,000 mi (1,600 km).

DRIVING ECONOMICALLY

The following helps to improve fuel consumption:

- Drive smoothly, accelerate gently and anticipate the road ahead to avoid heavy braking.
- Regularly check your tire pressures and make sure that they are inflated to the correct pressure.
- Follow the recommended maintenance schedule and carry out the recommended checks.
- Plan your journey and check the traffic before you set off. It is more efficient to combine errands into a single trip whenever possible.
- Avoid idling the engine in cold weather or for extended periods. Start the engine only when you are ready to set off.
- Do not carry unnecessary weight in your vehicle as extra weight wastes fuel.
- Do not add unnecessary accessories to the exterior of your vehicle, for example running boards. If you use a roof rack, remember to fold it down or remove it when not in use.
- Do not shift into neutral when you are braking or when your vehicle is slowing down.

- Shut all windows when driving at high speeds.
- Switch off all electric systems when not in use, for example air conditioning. Make sure that you unplug any accessories from the auxiliary power points when not in use.

DRIVING IN COLD WEATHER

The functional operation of some components and systems can be affected at temperatures below approximately -13°F (-25°C).

Driving on Snow and Ice



WARNING: If you are driving in slippery conditions that require tire chains or cables, then it is critical that you drive cautiously. Keep speeds down, allow for longer stopping distances and avoid aggressive steering to reduce the chances of a loss of vehicle control which can lead to serious injury or death. If the rear end of your vehicle slides while cornering, steer in the direction of the slide until you regain control of your vehicle.

On ice and snow, you should drive more slowly than usual. Your vehicle has a four wheel anti-lock brake system, do not pump the brake pedal. See **Anti-Lock Braking System Limitations** (page 215).

In snow and ice, all-wheel drive vehicles have advantages over two-wheel drive vehicles but can still skid. When driving on snowy or icy roads, should you start to slide, turn the steering wheel in the direction of the slide until you regain control.

Driving Hints

On snow and ice, avoid suddenly applying power and avoid quick change of direction. Apply the accelerator slowly and steadily when starting from a stop.

Avoid sudden braking. An all-wheel drive vehicle may accelerate better than a two-wheel drive vehicle in snow and ice. However, an all-wheel drive vehicle will not stop any faster, as braking occurs at all four wheels. Do not become overconfident to road conditions.

FLOOR MATS



WARNING: Use a floor mat designed to fit the footwell of your vehicle that does not obstruct the pedal area. Failure to follow this instruction could result in the loss of control of your vehicle, personal injury or death.



WARNING: Pedals that cannot move freely can cause loss of vehicle control and increase the risk of serious personal injury.



WARNING: Secure the floor mat to both retention devices so that it cannot slip out of position and interfere with the pedals. Failure to follow this instruction could result in the loss of control of your vehicle, personal injury or death.



WARNING: Do not place additional floor mats or any other covering on top of the original floor mats. This could result in the floor mat interfering with the operation of the pedals. Failure to follow this instruction could result in the loss of control of your vehicle, personal injury or death.



WARNING: Always make sure that objects cannot fall into the driver foot well while your vehicle is moving. Objects that are loose can become trapped under the pedals causing a loss of vehicle control.



To install floor mats that have eyelets, position the floor mat eyelet over the retention post and press down to lock in position. Repeat for all eyelets on the floor mat.

To remove the floor mats, reverse the installation procedure.

Note: Regularly check the floor mats to make sure they are secure.

Crash and Breakdown Information

ROADSIDE ASSISTANCE

Vehicles Sold in the United States: Getting Roadside Assistance

If you have a vehicle concern, Ford Motor Company offers a complimentary roadside assistance program. This program is separate from the New Vehicle Limited Warranty.

The service is available:

- 24 hours a day, seven days a week.
- For the coverage period supplied with your vehicle.

Knowing your vehicle's VIN, mileage and your specific location allows help to get to you faster.

Roadside Assistance covers:

- A flat tire change with a good spare (except vehicles supplied with a tire inflation kit).
- Battery jump start.
- Lock-out assistance (key replacement cost is the customer's responsibility).
- Fuel delivery — independent service contractors, if not prohibited by state, local or municipal law, shall deliver up to 2 gal (8 L) of gasoline or 5 gal (20 L) of diesel fuel to a disabled vehicle. Roadside assistance limits fuel delivery service to two no-charge occurrences within a 12-month period.
- Winch out — available within 100 ft (30 m) of a paved or county maintained road, no recoveries.

- Towing — independent service contractors, if not prohibited by state, local or municipal law, shall tow Ford eligible vehicles to an authorized dealer within 50 mi (80 km) of the disablement location or to the nearest authorized dealer. If a member requests a tow to an authorized dealer that is more than 50 mi (80 km) from the disablement location, the member shall be responsible for any mileage costs in excess of 50 mi (80 km). Warranty towing, non-warranty towing and collision towing are available.
- Roadside Assistance includes up to \$200 for a towed trailer if the disabled eligible vehicle requires service at the nearest authorized dealer. If the towing vehicle is operational but the trailer is not, then the trailer does not qualify for any roadside services.

Vehicles Sold in the United States: Using Roadside Assistance

United States vehicle customers who require Roadside Assistance, call 1-800-241-3673.

If you need to arrange roadside assistance on your own, Ford Motor Company reimburses a reasonable amount for towing to the nearest dealership within 50 mi (80 km). To obtain reimbursement information, United States vehicle customers call 1-800-241-3673. Customers need to submit their original receipts.

Vehicles Sold in Canada: Getting Roadside Assistance

If you have a vehicle concern, Ford Motor Company of Canada, Limited offers a complimentary roadside assistance program. This program is eligible within Canada or the continental United States.

The service is available 24 hours a day, seven days a week.

Crash and Breakdown Information

This program is separate from the New Vehicle Limited Warranty, but the coverage is concurrent with the powertrain coverage period of your vehicle. Canadian roadside coverage and benefits may differ from the U.S. coverage. For complete details, see your Warranty Guide at www.ford.com/support/warranty/.

Download the Sykes4Ford Roadside Assistance App for access to your roadside assistance services. For more information, scan here:



If you require more information, please call us in Canada at 1-800-665-2006, or visit our website at www.ford.ca.

Ford Motor Company reserves the right to modify or discontinue Roadside Assistance at any time. Certain restrictions apply to Roadside Assistance benefits.

For further details, call
1-800-241-3673 (United States)
1-800-665-2006 (Canada)

SWITCHING THE HAZARD FLASHERS ON AND OFF



The hazard flasher button is on the instrument panel. Press the button to switch the hazard flashers on if your vehicle is creating a safety hazard for other road users.

When you switch the hazard flashers on, all front and rear direction indicators flash.

Note: *The hazard flashers operate when the ignition is in any position, or if the key is not in the ignition. The battery loses charge and could have insufficient power to restart your vehicle.*

Press the button again to switch them off.

JUMP STARTING THE VEHICLE

JUMP STARTING PRECAUTIONS



WARNING: Batteries normally produce explosive gases which can cause personal injury. Therefore, do not allow flames, sparks or lighted substances to come near the battery. When working near the battery, always shield your face and protect your eyes. Always provide correct ventilation.



WARNING: Keep batteries out of reach of children. Batteries contain sulfuric acid. Avoid contact with skin, eyes or clothing. Shield your eyes when working near the battery to protect against possible splashing of acid solution. In case of acid contact with skin or eyes, flush immediately with water for a minimum of 15 minutes and get prompt medical attention. If acid is swallowed, call a physician immediately.



WARNING: Use only adequately sized cables with insulated clamps.



WARNING: Make sure that the cables are clear of any moving parts and fuel delivery system parts.



WARNING: Connect batteries with only the same nominal voltage.

Crash and Breakdown Information



WARNING: If the engine is running while the hood is open, stay clear of moving engine components. Failure to follow this warning could result in serious personal injury or death.

Do not attempt to push-start an automatic transmission vehicle. This could cause transmission damage.

Do not disconnect the battery of the disabled vehicle. This could damage your vehicle's electrical system.

PREPARING THE VEHICLE

Use only a 12 volt supply to start your vehicle.

Park the booster vehicle close to the hood of the disabled vehicle, making sure the two vehicles do not touch.

JUMP STARTING THE VEHICLE

Connecting the Jumper Cables



WARNING: Do not connect the negative jumper cable to any other part of your vehicle. Use the ground point.

Note: If you are using a jump pack or booster box, follow the manufacturer's instructions.

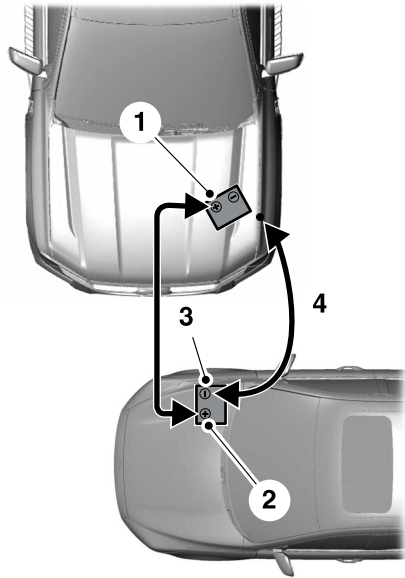

1. Unlatch the red cover to access the positive (+) terminal. Connect the positive (+) jumper cable to the positive (+) terminal of the discharged battery.
2. Connect the other end of the positive (+) jumper cable to the positive (+) terminal of the booster vehicle battery.
3. Connect the negative (-) jumper cable to the negative (-) terminal of the booster vehicle battery.
4. Make the final connection of the negative (-) jumper cable to an exposed metal part of the disabled vehicle's engine, as shown in the following illustration, away from the battery and fuel injection system, or connect the negative (-) jumper cable to a ground connection point if available.

Crash and Breakdown Information

Note: Do not use the hood latch as a negative (-) connection point. This could cause springs in the latch to burn and prevent the hood from operating correctly.

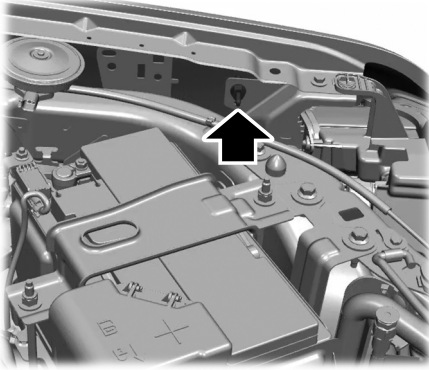

Starting the Engine

1. Start the engine of the booster vehicle and moderately rev the engine, or gently press the accelerator to keep the engine speed between 2000 RPM and 3000 RPM, as shown in your tachometer.
2. Start the engine of the disabled vehicle.
3. Once you start the disabled vehicle, run both vehicle engines for an additional three minutes before disconnecting the jumper cables.

Removing the Jumper Cables

Remove the jumper cables in the reverse order that they were connected.

Note: Do not switch the headlamps on when disconnecting the cables. The peak voltage could blow the bulbs.

POST-CRASH ALERT SYSTEM

WHAT IS THE POST-CRASH ALERT SYSTEM

The system helps draw attention to your vehicle in the event of a serious impact.

HOW DOES THE POST-CRASH ALERT SYSTEM WORK

The system is designed to turn the hazard flashers on, turn the courtesy lamps on, intermittently sound the horn and unlock all doors in the event of a serious impact that deploys an airbag or the seatbelt pretensioners.

POST-CRASH ALERT SYSTEM LIMITATIONS

Depending on applicable laws in the country your vehicle was built for, the horn does not sound in the event of a serious impact.

SWITCHING THE POST-CRASH ALERT SYSTEM OFF

Press the hazard flasher switch, the unlock button on the remote control, the panic button on the remote control or cycle the ignition to switch the system off.

Note: The alert turns off when the vehicle battery runs out of charge.

POST-COLLISION BRAKING

How Does Post-Collision Braking Work

In the event of a moderate to severe crash, the braking system reduces the vehicle's speed to prevent or reduce the impact of a potential secondary crash.

Crash and Breakdown Information

Post-Collision Braking Limitations

Post-collision braking does not activate if any of the following occur:

- The anti-lock braking system is damaged during the collision.
- Electronic stability control is disabled.

Overriding Post-Collision Braking

You can override post-collision braking by pressing the brake or accelerator pedal.

Post-Collision Braking Indicators



It flashes when a post-collision braking event is occurring.

AUTOMATIC CRASH SHUTOFF

WHAT IS AUTOMATIC CRASH SHUTOFF

The automatic crash shutoff is designed to stop the fuel going to the engine in the event of a moderate or severe crash.

Note: *Not every impact causes a shutoff.*

AUTOMATIC CRASH SHUTOFF PRECAUTIONS



WARNING: If your vehicle has been involved in a crash, have the fuel system checked. Failure to follow this instruction could result in fire, personal injury or death.

RE-ENABLING YOUR VEHICLE

1. Switch the ignition off.
2. Attempt to start your vehicle.
3. Switch the ignition off.

4. Attempt to start your vehicle.

Note: *If your vehicle does not start after the third attempt, have your vehicle checked as soon as possible.*

RECOVERY TOWING

ACCESSING THE FRONT TOWING POINT (If Equipped)



WARNING: Using recovery hooks is dangerous and should only be done by a person familiar with proper vehicle recovery safety practices. Improper use of recovery hooks may cause hook failure or separation from the vehicle and could result in serious injury or death.



WARNING: Slowly remove the slack from the recovery strap prior to pulling. Failure to do so can introduce significantly higher loads which can cause the recovery hooks to break off, or the recovery strap to fail which can cause serious injury or death.



WARNING: Never link two straps together with a clevis pin. These heavy metal objects could become projectiles if the strap breaks and can cause serious injury or death.

Crash and Breakdown Information

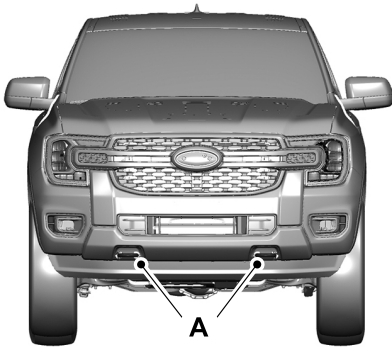

A. Front recovery hooks.

Note: Your vehicle's front towing point configuration may be slightly different.

Note: Do not apply a load to the recovery hooks that is greater than the gross vehicle weight rating of your vehicle.

Before using recovery hooks:

- Make sure all attaching points are secure and capable of withstanding the applied load.
- Do not use chains, cables or tow straps with metal hook ends.
- Only use recovery straps that have a minimum breaking strength two to three times the gross vehicle weight of the stuck vehicle.
- Make sure the recovery strap is in good condition and free of visible cuts, tears or damage.
- Use a damper device such as a tarp, heavy blanket or piece of carpet, and place it over the recovery strap to help absorb the energy in the event the strap breaks.

- Make sure the stuck vehicle is not loaded heavier than its gross vehicle weight rating specified on the certification label.
- Align the tow vehicle and stuck vehicle in a straight line, within 10 degrees.
- Keep bystanders to the sides of the vehicle, at a distance of at least twice the length of the recovery strap. This helps avoid injury from the hazard of a recovery hook or strap breaking, or a vehicle lurching into their path.

ACCESSING THE REAR TOWING POINT



WARNING: Using recovery hooks is dangerous and should only be done by a person familiar with proper vehicle recovery safety practices. Improper use of recovery hooks may cause hook failure or separation from the vehicle and could result in serious injury or death.



WARNING: Slowly remove the slack from the recovery strap prior to pulling. Failure to do so can introduce significantly higher loads which can cause the recovery hooks to break off, or the recovery strap to fail which can cause serious injury or death.



WARNING: Never link two straps together with a clevis pin. These heavy metal objects could become projectiles if the strap breaks and can cause serious injury or death.

Crash and Breakdown Information

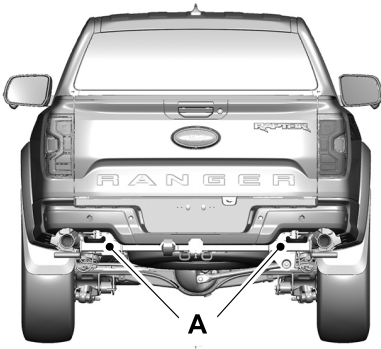

A. Rear recovery hooks.

Note: Do not apply a load to the recovery hooks that is greater than the gross vehicle weight rating of your vehicle.

Before using recovery hooks:

- Make sure all attaching points are secure and capable of withstanding the applied load.
- Do not use chains, cables or tow straps with metal hook ends.
- Only use recovery straps that have a minimum breaking strength two to three times the gross vehicle weight of the stuck vehicle.
- Make sure the recovery strap is in good condition and free of visible cuts, tears or damage.
- Use a damper device such as a tarp, heavy blanket or piece of carpet, and place it over the recovery strap to help absorb the energy in the event the strap breaks.
- Make sure the stuck vehicle is not loaded heavier than its gross vehicle weight rating specified on the certification label.

- Align the tow vehicle and stuck vehicle in a straight line, within 10 degrees.
- Keep bystanders to the sides of the vehicle, at a distance of at least twice the length of the recovery strap. This helps avoid injury from the hazard of a recovery hook or strap breaking, or a vehicle lurching into their path.

TRANSPORTING THE VEHICLE

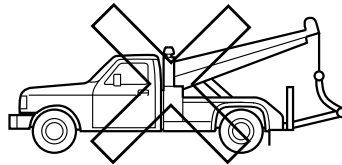
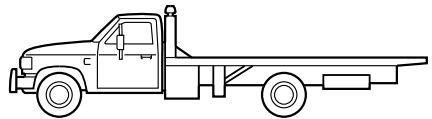
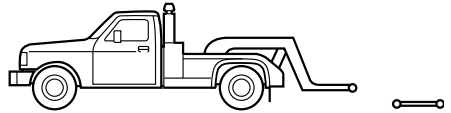

If you need to tow your vehicle, contact a professional towing service or your roadside assistance service provider.

Your manufacturer produces a towing manual for all authorized tow truck operators. Have your tow truck operator refer to this manual for proper hook-up and towing procedures.

Crash and Breakdown Information

We recommend the use of a wheel lift and dollies or flatbed equipment to tow your vehicle. Vehicle damage could occur if towed incorrectly, or by any other means.

Front-wheel and rear-wheel drive vehicles must have their designated drive wheels off the ground regardless of towing direction. Use tow dollies to prevent damage to the transmission.

All-wheel or four-wheel drive vehicles require that all wheels be off the ground using a wheel lift and dollies or flatbed equipment. This prevents damage to the transmission and drive system.

Note: You need to switch on the ignition to unlock the steering.

Note: Make sure you check the steering column before towing. It could lock if the battery is dead.

FAIL-SAFE COOLING

WHAT IS FAIL-SAFE COOLING

Fail-safe cooling allows you to temporarily drive your vehicle before any incremental component damage occurs due to overheating.

The fail-safe distance depends on outside temperature, vehicle load and terrain.

HOW DOES FAIL-SAFE COOLING WORK

If the engine reaches a preset over-temperature condition, the engine automatically switches to alternating cylinder operation. Each disabled cylinder acts as an air pump and cools the engine.

When this occurs, your vehicle still operates, however:

- Engine power is limited.
- The air conditioning system turns off.

Continued operation increases the engine temperature, causing the engine to completely shut down. Your steering and braking effort increases in this situation.

When the engine temperature cools, you can re-start the engine.

Note: Have your vehicle checked as soon as possible to minimize engine damage.

DRIVING WHEN FAIL-SAFE MODE IS ACTIVATED



WARNING: Fail-safe mode is for use during emergencies only. Operate your vehicle in fail-safe mode only as long as necessary to bring your vehicle to rest in a safe location and seek immediate repairs. When in fail-safe mode, your vehicle will have limited power, will not be able to maintain high-speed operation, and may completely shut down without warning, potentially losing engine power, power steering assist, and power brake assist, which may increase the possibility of a crash resulting in serious injury.



WARNING: Do not remove the coolant reservoir cap when the engine is on or the cooling system is hot. Wait 10 minutes for the cooling system to cool down. Cover the coolant reservoir cap with a thick cloth to prevent the possibility of scalding and slowly remove the cap. Failure to follow this instruction could result in personal injury.

Continued operation increases the engine temperature, causing the engine to completely shut down. Your steering and braking effort increases in this situation.

When the engine temperature cools, you can re-start the engine. Have your vehicle checked as soon as possible to minimize engine damage.

Crash and Breakdown Information

Your vehicle has limited engine power when in the fail-safe mode, drive your vehicle with caution. Your vehicle does not maintain high-speed operation and the engine may operate poorly.

Remember that the engine is capable of automatically shutting down to prevent engine damage. In this situation:

1. Pull off the road as soon as safely possible and switch the engine off.
2. If you are a member of a roadside assistance program, we recommend that you contact your roadside assistance service provider.
3. If this is not possible, wait for a short period of time for the engine to cool.
4. Check the coolant level. If the coolant level is at or below the minimum mark, add prediluted coolant immediately.
5. When the engine temperature cools, you can re-start the engine. Have your vehicle checked as soon as possible to minimize engine damage.

Note: *Driving your vehicle without repair increases the chance of engine damage.*

FAIL-SAFE COOLING INDICATORS



If the engine begins to overheat, the coolant temperature gauge moves toward the red zone.



A warning lamp illuminates and a message may appear in the instrument cluster display.

Towing Your Vehicle

TOWING YOUR VEHICLE PRECAUTIONS

Use the following guidelines when towing your vehicle. Failure to follow this instruction could result in vehicle damage not covered by the vehicle warranty.

Note: *Make sure you properly secure your vehicle to the tow vehicle.*

Note: *If you are unsure of the vehicle's configuration, contact an authorized dealer.*

RECREATIONALLY TOWING YOUR VEHICLE

You cannot recreational tow your vehicle with all wheels on the ground because vehicle or transmission damage could occur. You must recreational tow your vehicle with all four wheels off the ground, such as when using a car-hauling trailer. Otherwise, you cannot recreational tow your vehicle.

EMERGENCY TOWING

If your vehicle becomes inoperable without access to wheel dollies or a vehicle transport trailer, it can be flat-towed with all wheels on the ground, regardless of the powertrain and transmission configuration, under the following conditions:

- Your vehicle is facing forward for towing in a forward direction.
- Use the manual park release procedure. See **Using Manual Park Release** (page 196). Failure to do so may result in damage to the transmission.
- Maximum speed is 35 mph (56 km/h).
- Maximum distance is 50 mi (80 km).

Fuses

FUSE PRECAUTIONS



WARNING: Always disconnect the battery before servicing high current fuses.



WARNING: To reduce risk of electrical shock, always replace the cover to the power distribution box before reconnecting the battery or refilling fluid reservoirs.



WARNING: Always replace a fuse with one that has the specified amperage rating. Using a fuse with a higher amperage rating can cause severe wire damage and could start a fire.

UNDER HOOD FUSE BOX

LOCATING THE UNDER HOOD FUSE BOX

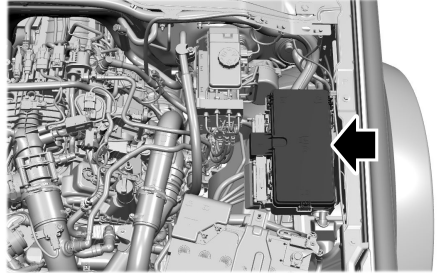

ACCESSING THE UNDER HOOD FUSE BOX

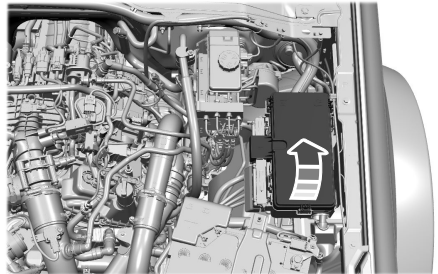

Fuses

IDENTIFYING THE FUSES IN THE UNDER HOOD FUSE BOX

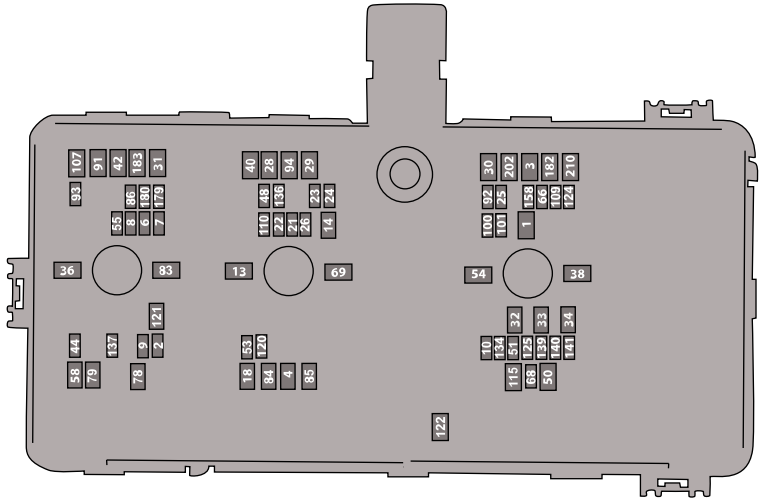

Item	Rating	Protected Component
1	30 A	Body control module 1.
2	20 A	Crankcase ventilation heater (2.0L, 3.0L diesel).
3	30 A	Body control module 2.
4	30 A	Fuel pump.
5	—	Not used.
6	25 A	Powertrain control module power.
7	30 A	Exhaust gas recirculation bypass valve (3.0L diesel). Vacuum solenoid valve (2.0L).

Fuses

Item	Rating	Protected Component
8	20 A	Heater positive crankcase ventilation valve (3.0L diesel). Variable oil pump (3.0L diesel). Active grille shutter motor. Cooling fan relays. A/C clutch solenoid. Auxiliary water pump. Aspirate valve control.
9	20 A	Glow plug control module (diesel). Particulate matter sensor (diesel). Nitrogen oxide sensor (diesel). 4x4 relay coil.
10	20 A	Fuel volume control valve (3.0L diesel). Transmission control module.
11	—	Not used.
12	—	Not used.
13	40 A	Front blower motor.
14	20 A	Automatic transmission fluid pump (diesel).
15	—	Not used.
16	—	Not used.
17	—	Not used.
18	30 A	Starter motor.
19	—	Not used.
20	—	Not used.
21	10 A	Automatic headlamp leveling.
22	—	Not used.

Fuses

Item	Rating	Protected Component
23	10 A	Anti-lock brake system module.
24	10 A	Powertrain control module. Glow plug control module (2.0L , 3.0L diesel) Electronic power assist steering.
25	20 A	Driveline control module. Rear camera.
26	15 A	Transmission control module. Transmission oil pump. Automatic transmission fluid pump (diesel).
27	—	Not used.
28	60 A	Anti-lock brake system valves.
29	60 A	Anti-lock brake system pump.
30	40 A	Left-hand power seat.
31	40 A	Right-hand power seat.
32	20 A	Power point - first row.
33	20 A	Power point - rear console.
34	20 A	Rear cargo power outlet - bedliner power point.
35	—	Not used.
36	60 A	Inverter.
37	—	Not used.
38	40 A	Heated seats control module.
39	—	Not used.
40	30 A	Not used (spare).
41	—	Not used.

Fuses

Item	Rating	Protected Component
42	30 A	Not used (spare).
43	—	Not used.
44	10 A	Brake switch.
45	—	Not used.
46	—	Not used.
47	—	Not used.
48	30 A	Not used (spare).
49	—	Not used.
50	40 A	Heated backlite.
51	15 A	Not used (spare).
52	—	Not used.
53	15 A	Rear electronic differential lock.
54	40 A	Driveline control module.
55	30 A	Trailer tow park lamp.
56	—	Not used.
57	—	Not used.
58	15 A	Trailer tow backup lamp.
59	—	Not used.
60	—	Not used.
61	—	Not used.
62	—	Not used.
63	—	Not used.
64	—	Not used.
65	—	Not used.
66	10 A	Not used (spare).
67	—	Not used.

Fuses

Item	Rating	Protected Component
68	20 A	Not used (spare).
69	30 A	Wiper motor.
70	—	Not used.
71	—	Not used.
72	—	Not used.
73	—	Not used.
74	—	Not used.
75	—	Not used.
76	—	Not used.
77	—	Not used.
78	—	Not used.
79	—	Not used.
80	—	Not used.
81	—	Not used.
82	—	Not used.
83	50 A	Not used (spare).
84	50 A	Not used (spare).
85	50 A	Not used (spare).
86	15 A	Selective catalytic reduction system heater 2 (2.0L, 3.0L diesel).
87	—	Not used.
88	—	Not used.
89	—	Not used.
90	—	Not used.
91	40 A	Trailer tow module.
92	10 A	Accessory.
93	5 A	Not used (spare).

Fuses

Item	Rating	Protected Component
94	20 A	Not used (spare).
95	—	Not used.
96	—	Not used.
97	—	Not used.
98	—	Not used.
99	—	Not used.
100	20 A	Left-hand headlamps.
101	20 A	Right-hand headlamps.
102	—	Not used.
103	—	Not used.
104	—	Not used.
105	—	Not used.
106	—	Not used.
107	30 A	Trailer tow module - battery charger.
108	—	Not used.
109	20 A	Not used (spare).
110	30 A	Trailer tow auxiliary.
111	—	Not used.
112	—	Not used.
113	—	Not used.
114	—	Not used.
115	30 A	Power roller shutter.
116	—	Not used.
117	—	Not used.
118	—	Not used.
119	—	Not used.

Fuses

Item	Rating	Protected Component
120	10 A	Fuel injectors (2.7L).
121	40 A	Water in fuel heater (diesel).
122	30 A	Transfer case control module.
123	—	Not used.
124	5 A	Rain sensor.
125	10 A	Not used (spare).
126	—	Not used.
127	—	Not used.
128	—	Not used.
129	—	Not used.
130	—	Not used.
131	—	Not used.
132	—	Not used.
133	—	Not used.
134	25 A	Not used (spare).
135	—	Not used.
136	—	Not used.
137	20 A	Advanced driver assistance system.
138	—	Not used.
139	5 A	Not used (spare).
140	5 A	USB smart charge port - rear console.
141	5 A	USB smart charge port - top.
142	—	Not used.
143	—	Not used.
145	—	Not used.

Fuses

Item	Rating	Protected Component
146	—	Not used.
147	—	Not used.
148	—	Not used.
149	—	Not used.
150	—	Not used.
151	—	Not used.
152	—	Not used.
153	—	Not used.
154	—	Not used.
155	—	Not used.
156	—	Not used.
157	—	Not used.
158	10 A	Not used (spare).
159	—	Not used.
160	—	Not used.
161	—	Not used.
162	—	Not used.
163	—	Not used.
164	—	Not used.
165	—	Not used.
166	—	Not used.
167	—	Not used.
168	—	Not used.
169	—	Not used.
170	—	Not used.
171	—	Not used.
172	—	Not used.

Fuses

Item	Rating	Protected Component
173	—	Not used.
174	—	Not used.
175	—	Not used.
176	—	Not used.
177	—	Not used.
178	—	Not used.
179	15 A	Selective catalytic reduction system heater 1 (diesel).
180	10 A	Selective catalytic reduction system heater 3 (diesel).
181	—	Not used.
182	60 A	Drive door module.
183	60 A	Passenger door module.
192	—	Not used.
202	60 A	Body control module B+.
210	30 A	Body control module start-stop.

Fuses

BATTERY FUSE BOX

LOCATING THE BATTERY FUSE BOX

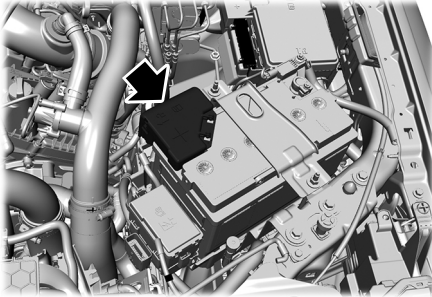

IDENTIFYING THE FUSES IN THE BATTERY FUSE BOX

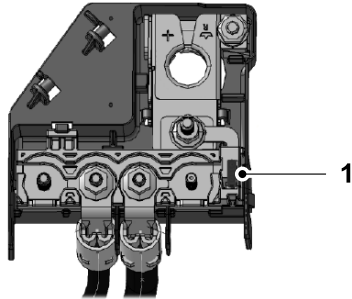

Item	Rating	Protected Component
1	3 A	Battery Monitoring System.

ACCESSING THE BATTERY FUSE BOX

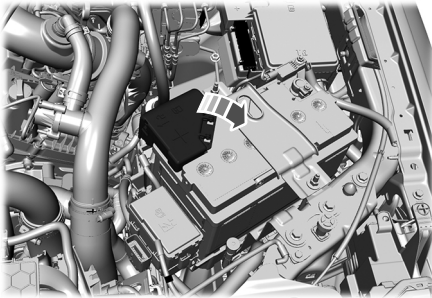

BODY CONTROL MODULE FUSE BOX

LOCATING THE BODY CONTROL MODULE FUSE BOX

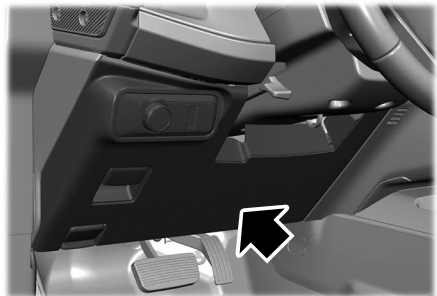

Fuses

ACCESSING THE BODY CONTROL MODULE FUSE BOX

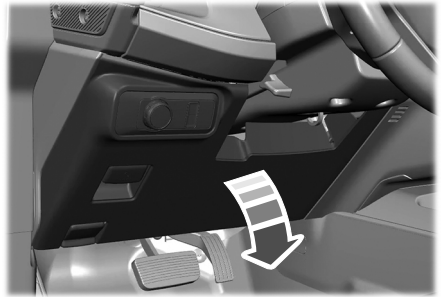

IDENTIFYING THE FUSES IN THE BODY CONTROL MODULE FUSE BOX

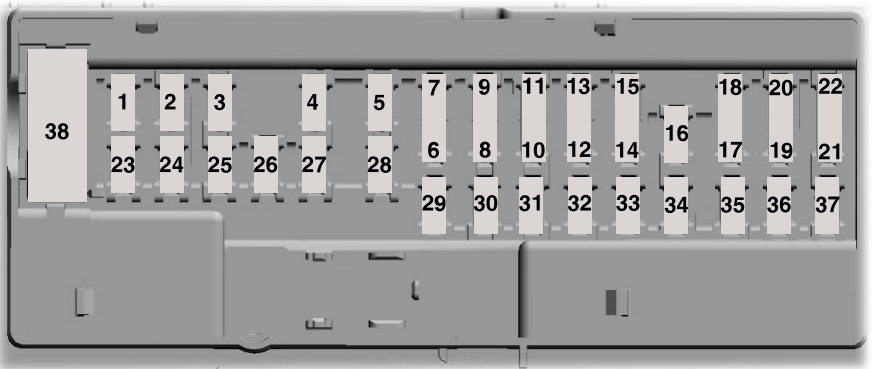

Item	Rating	Protected Component
1	—	Not used.
2	10 A	Inverter. Door lock switch. Power window switch.
3	7.5 A	Wireless accessory charging module.

Fuses

Item	Rating	Protected Component
4	—	Not used.
5	—	Not used.
6	10 A	Alarm horn. Battery backup sounder.
7	10 A	Not used (spare).
8	5 A	Telematics modem.
9	—	Not used.
10	—	Not used.
11	—	Not used.
12	7.5 A	Climate control module. Gear shift module. Enhanced central gateway module.
13	7.5 A	Steering column control module. Instrument panel.
14	—	Not used.
15	15 A	On board diagnostic connector. SYNC.
16	—	Not used.
17	7.5 A	Adaptive front lighting module.
18	7.5 A	Auxiliary switch.
19	5 A	Headlamp switch pack.
20	5 A	Ignition switch. Push button switch.
21	5 A	Not used (spare).
22	5 A	Not used (spare).
23	30 A	Not used (spare).
24	30 A	Moonroof.

Fuses

Item	Rating	Protected Component
25	20 A	Not used (spare).
26	30 A	Not used (spare).
27	30 A	Not used (spare).
28	30 A	Not used (spare).
29	15 A	Display.
30	—	Not used.
31	10 A	Terrain management switch. Integrated control module. Radio frequency receiver module.
32	20 A	Audio control module.
33	—	Not used.
34	—	Not used.
35	—	Not used.
36	15 A	Parking aid module.
37	20 A	Electrochromatic mirror. Steering wheel control module.
38	—	Not used.

Fuses

IDENTIFYING FUSE TYPES

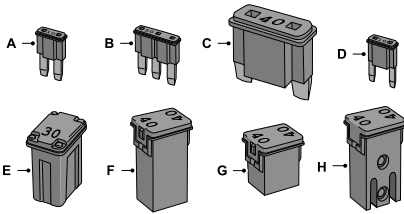

- A Micro 2.
- B Micro 3.
- C Maxi.
- D Mini.
- E M Case.
- F J Case.
- G J Case Low Profile.
- H Slotted M Case.

FUSES – TROUBLESHOOTING

FUSES – FREQUENTLY ASKED QUESTIONS

When do I need to check a fuse?

- If electrical components in the vehicle are not working.

When do I need to replace a fuse?

- If a fuse has blown.

How do I identify a blown fuse?

- You can identify a blown fuse by a broken wire within the fuse.

Maintenance

MAINTENANCE PRECAUTIONS

Have your vehicle serviced regularly to help maintain its roadworthiness and resale value. There is a large network of authorized dealers that are there to help you with their professional servicing expertise. We believe that their specially trained technicians are best qualified to service your vehicle properly and expertly. They are supported by a wide range of highly specialized tools developed specifically for servicing your vehicle.

If your vehicle requires professional service, an authorized dealer can provide the necessary parts and service. Check your warranty information to find out which parts and services are covered.

Use only recommended fluids and service parts conforming to specifications. See **Capacities and Specifications** (page 471).



WARNING: Switch the ignition off and apply the parking brake.



WARNING: Do not touch the electronic ignition system parts after you have switched the ignition on or when the engine is running. The system operates at high voltage. Failure to adhere to this warning could result in serious personal injury or death.



WARNING: Keep your hands and clothing clear of the engine cooling fan.

OPENING AND CLOSING THE HOOD

Opening the Hood



1. Pull the hood release lever.

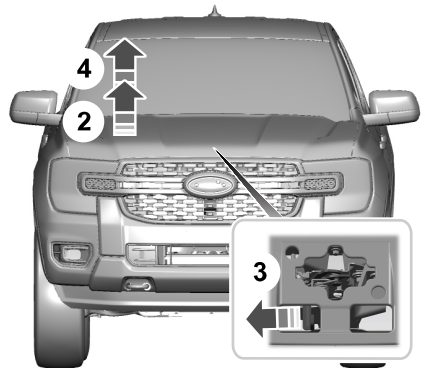

2. Slightly lift the hood.
3. Release the hood latch by pushing the secondary release lever to your left-hand side.

Maintenance

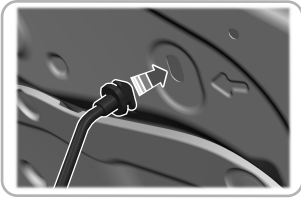

4. Open the hood and support it with the prop rod.

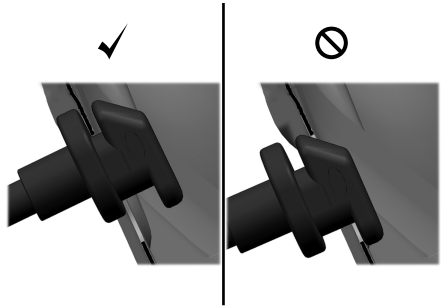

5. Make sure you fully engage the prop rod end cap with the hood.

Closing the Hood



WARNING: Make sure that you fully latch the hood before driving. Failure to follow this instruction could result in personal injury or death.

1. Fully stow the prop rod prior to lowering the hood.
2. To close, lower the hood and make sure that it fully latches.

Note: *Make sure the hood is closed completely.*

Maintenance

UNDER HOOD OVERVIEW - 2.3L ECOBOOST™

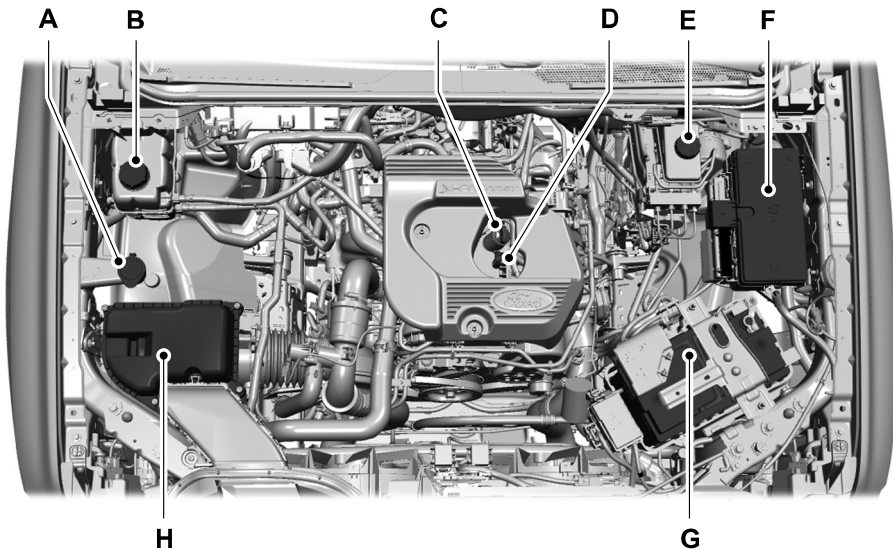

- A Washer fluid reservoir. See **Adding Washer Fluid** (page 95).
- B Engine coolant reservoir. See **Checking the Coolant Level** (page 408).
- C Engine oil filler cap. See **Adding Engine Oil** (page 406).
- D Engine oil dipstick. See **Checking the Engine Oil Level** (page 406).
- E Brake fluid reservoir. See **Checking the Brake Fluid** (page 216).
- F Engine compartment fuse box. See **Identifying the Fuses in the Under Hood Fuse Box** (page 387).
- G Battery. See **Changing the 12V Battery** (page 413).
- H Air filter assembly. See **Changing the Engine Air Filter** (page 407).

Maintenance

UNDER HOOD OVERVIEW - 2.7L ECOBOOST™

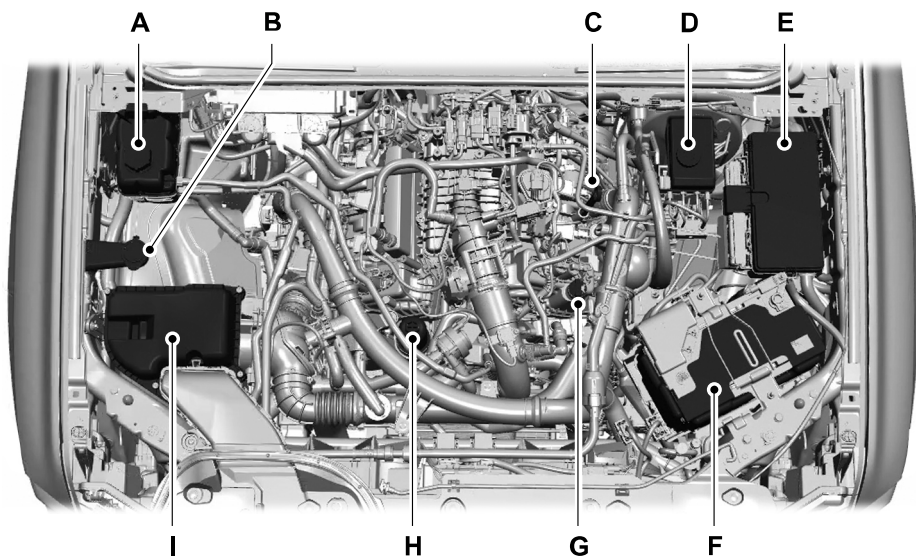

- A Engine coolant reservoir. See **Checking the Coolant Level** (page 408).
- B Windshield washer fluid. See **Adding Washer Fluid** (page 95).
- C Engine oil dipstick. See **Adding Engine Oil** (page 406).
- D Brake fluid reservoir. See **Checking the Brake Fluid** (page 216).
- E Engine compartment fuse box. See **Fuses** (page 386).
- F Battery. See **Changing the 12V Battery** (page 413).
- G Engine oil filler cap. See **Adding Engine Oil** (page 406).
- H Oil filter.
- I Air Filter. See **Changing the Engine Air Filter** (page 407).

Maintenance

UNDER HOOD OVERVIEW - 3.0L ECOBOOST™

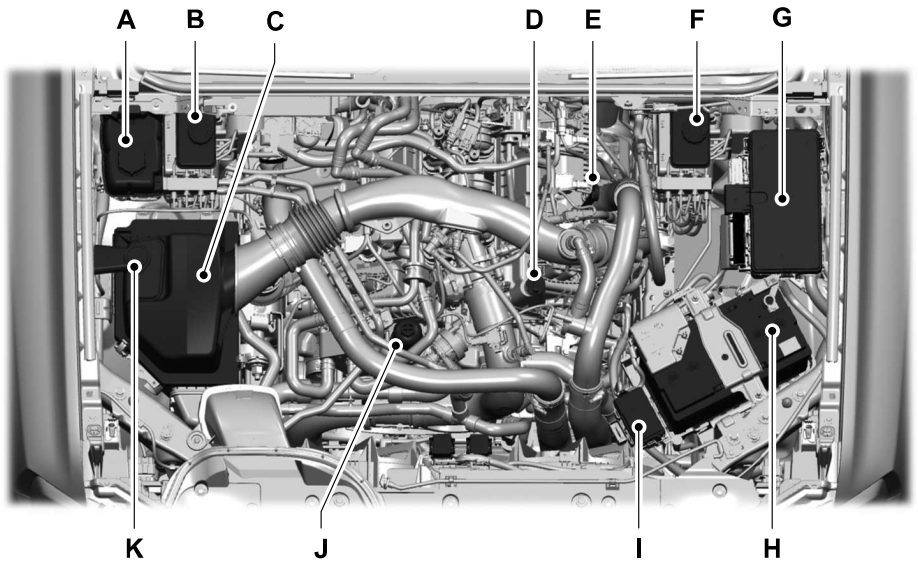

- A Engine coolant reservoir. See **Checking the Coolant Level** (page 408).
- B Brake fluid reservoir - Right-hand drive. See **Checking the Brake Fluid** (page 216).
- C Air filter. See **Changing the Engine Air Filter** (page 407).
- D Engine oil filler cap. See **Adding Engine Oil** (page 406).
- E Engine oil dipstick. See **Checking the Engine Oil Level** (page 406).
- F Brake fluid reservoir - Left-hand drive. See **Checking the Brake Fluid** (page 216).
- G Engine compartment fuse box. See **Fuses** (page 386).
- H Battery. See **Changing the 12V Battery** (page 413).
- I Engine compartment accessory fuse box. See **Fuses** (page 386).
- J Oil filter.
- K Windshield washer fluid. See **Adding Washer Fluid** (page 95).

Maintenance

ENGINE OIL

ENGINE OIL DIPSTICK OVERVIEW

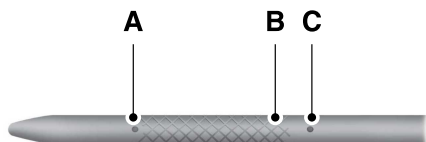

- A Minimum.
- B Nominal.
- C Maximum.

CHECKING THE ENGINE OIL LEVEL

1. Make sure that your vehicle is on level ground.
2. Check the oil level before starting the engine, or switch the engine off after warm up and wait 15 minutes for the oil to drain into the oil pan.

Note: *Checking the oil level too soon could result in an inaccurate reading.*

3. Remove the dipstick and wipe it with a clean, lint-free cloth.
4. Reinstall the dipstick and make sure it is fully seated.
5. Remove the dipstick again to check the oil level.

Note: *If the oil level is between the maximum and minimum marks, the oil level is acceptable. Do not add oil.*

6. If the oil level is at the minimum mark, immediately add oil.

7. Reinstall the dipstick. Make sure it is fully seated.

Note: *The oil consumption of new engines reaches its normal level after approximately 3,000 mi (5,000 km).*

Note: *Increases in oil level can occur from frequent short trips that do not allow the engine to get to operating temperature, as well as frequent idling or low speed driving for long periods of time.*

Note: *If oil levels are continuously noted above the maximum mark, have your vehicle checked as soon as possible.*

ADDING ENGINE OIL



WARNING: Do not remove the filler cap when the engine is running.



WARNING: Do not add engine oil when the engine is hot. Failure to follow this instruction could result in personal injury.

Do not use supplemental engine oil additives because they are unnecessary and could lead to engine damage that the vehicle warranty may not cover.

1. Clean the area surrounding the engine oil filler cap before you remove it.
2. Remove the engine oil filler cap.
3. Add engine oil that meets our specifications. See **Capacities and Specifications** (page 471).
4. Reinstall the engine oil filler cap. Turn it clockwise until you feel a strong resistance.

Note: *Do not add oil further than the maximum mark. Oil levels above the maximum mark may cause engine damage.*

Note: *Immediately soak up any oil spillage with an absorbent cloth.*

Maintenance

INTELLIGENT OIL LIFE MONITOR

Under certain conditions the vehicle's intelligent oil life monitor may determine your oil requires replacement prior to your general service. Should this occur it is recommended you replace your oil within two weeks or 500 mi (800 km) of being alerted.

Your authorized dealer will be able to advise you whether only an engine oil and filter change is recommended or whether you should complete your general service inclusive of oil and oil filter.

RESETTING THE INTELLIGENT OIL LIFE MONITOR

Only reset the oil life monitoring system after changing the engine oil and oil filter.

1. Press the menu button on the steering wheel to enter the instrument cluster display main menu.
2. Select **Vehicle Maintenance**.
3. Select **Oil Life**.
4. Press and hold the **OK** button until the system reset confirmation appears.

ENGINE OIL CAPACITY AND SPECIFICATION

For filling information, please refer to the Capacities and Specifications section of your owner's manual. See **Capacities and Specifications** (page 471).

ENGINE OIL – INFORMATION MESSAGES

Message	Action
Change Engine Oil Soon	Displays when the engine oil life is becoming depleted. Have the engine oil changed as soon as possible.
Oil Change Required	Displays when the engine oil life is depleted. Have the engine oil changed as soon as possible.

ENGINE AIR FILTER

CHANGING THE ENGINE AIR FILTER



WARNING: To reduce the risk of vehicle damage and personal burn injuries, do not start your engine with the air cleaner removed and do not remove it while the engine is running.

Change the air filter element at the proper intervals.

When changing the air filter element, use only the air filter element listed. See **Capacities and Specifications** (page 471).

Note: Failure to use the correct air filter element could result in severe engine damage that the vehicle warranty may not cover.

Maintenance

Note: When servicing the air filter, do not allow foreign material to enter the air induction system. The engine is susceptible to damage from even small particles.

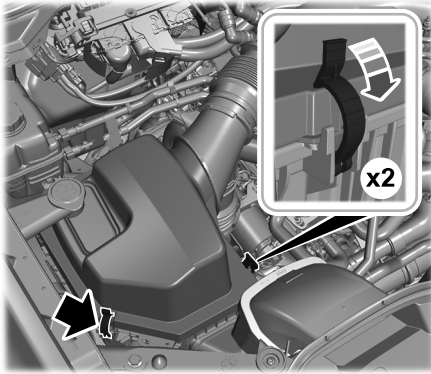

1. Release the two clips securing the air filter housing cover to the housing.
2. Carefully lift the air filter housing cover.
3. Remove the air filter element from the air filter housing.
4. To install, reverse the removal procedure.

COOLANT

CHECKING THE COOLANT LEVEL

WARNING: Do not remove the coolant reservoir cap when the engine is on or the cooling system is hot. Wait 10 minutes for the cooling system to cool down. Cover the coolant reservoir cap with a thick cloth to prevent the possibility of scalding and slowly remove the cap. Failure to follow this instruction could result in personal injury.

WARNING: To reduce the risk of personal injury, make sure the engine is cool before unscrewing the coolant pressure relief cap. The cooling system is under pressure. Steam and hot liquid can come out forcefully when you loosen the cap slightly.

When the engine is cold, check the concentration and level of the coolant at the intervals listed in the scheduled maintenance information. See **Scheduled Maintenance** (page 534).

Note: Make sure that the coolant level is between the **MIN** and the **MAX** marks on the coolant reservoir.

Note: Coolant expands when it is hot. The level may extend beyond the **MAX** mark. This is normal.

Maintain coolant concentration within 48% to 50%, which equates to a freeze point between -29°F (-34°C) and -35°F (-37°C). Coolant concentration should be checked using a refractometer. We do not recommend the use of hydrometers or coolant test strips for measuring coolant concentration.

ADDING COOLANT

WARNING: Do not add coolant when the vehicle is on or the cooling system is hot. Failure to follow this instruction could result in personal injury.

Maintenance



WARNING: Do not remove the coolant reservoir cap when the engine is on or the cooling system is hot. Wait 10 minutes for the cooling system to cool down. Cover the coolant reservoir cap with a thick cloth to prevent the possibility of scalding and slowly remove the cap. Failure to follow this instruction could result in personal injury.



WARNING: Do not allow the fluid to touch your skin or eyes. If this happens, rinse the affected areas immediately with plenty of water and contact your physician.



WARNING: Do not put coolant in the windshield washer reservoir. If sprayed on the windshield, coolant could make it difficult to see through the windshield.



WARNING: Do not add coolant further than the **MAX** mark.

Note: Do not use stop leak pellets, cooling system sealants, or non-specified additives as they can cause damage to the engine cooling or heating systems. Resulting component damage may not be covered by the vehicle Warranty.

Note: Automotive fluids are not interchangeable.

It is very important to use prediluted coolant approved to the correct specification in order to avoid plugging the small passageways in the engine cooling system. See **Capacities and Specifications** (page 471). Do not mix different colors or types of coolant in your vehicle. Mixing of engine coolants or using an incorrect coolant may harm the engine or cooling system components and may not be covered by the vehicle Warranty.

Note: If prediluted coolant is not available, use the approved concentrated coolant diluting it to 50/50 with deionised or distilled water. See **Capacities and Specifications** (page 471). Using water that has not been deionised may contribute to deposit formation, corrosion and plugging of the small cooling system passageways.

Note: Coolants marketed for all makes and models may not be approved to our specifications and may cause damage to the cooling system. Resulting component damage may not be covered by the vehicle Warranty.

If the coolant level is at or below the minimum mark, add prediluted coolant immediately.

To top up the coolant level do the following:

1. Unscrew the cap slowly. Any pressure escapes as you unscrew the cap.
2. Add prediluted coolant approved to the correct specification. See **Capacities and Specifications** (page 471).
3. Add enough prediluted coolant to reach the correct level.
4. Replace the coolant reservoir cap. Turn the cap clockwise until it contacts the hard stop.
5. Check the coolant level in the coolant reservoir the next few times you drive your vehicle. If necessary, add enough prediluted engine coolant to bring the coolant level to the correct level.

If you have to add more than 1.1 qt (1 L) of engine coolant per month, have your vehicle checked as soon as possible. Operating an engine with a low level of coolant can result in engine overheating and possible engine damage.

In case of emergency, you can add a large amount of water without engine coolant in order to reach a vehicle service location.

Maintenance

Water alone, without engine coolant, can cause engine damage from corrosion, overheating or freezing.

Do not use the following as a coolant substitute:

- Alcohol.
- Methanol.
- Brine.
- Any coolant mixed with alcohol or methanol antifreeze.

Alcohol and other liquids can cause engine damage from overheating or freezing.

Do not add extra inhibitors or additives to the coolant. These can be harmful and compromise the corrosion protection of the coolant.

CHANGING THE COOLANT

For coolant change, see your authorized dealer.

Changing the coolant is necessary at specific mileage intervals listed in the scheduled maintenance information. See **Scheduled Maintenance** (page 534).

MANAGING THE COOLANT TEMPERATURE

If you tow a trailer with your vehicle, the engine may temporarily reach a higher temperature during severe operating conditions, for example ascending a long or steep grade in high ambient temperatures.

At this time, you may notice the coolant temperature gauge moves toward the red zone and a message may appear in the information display.



WARNING: To reduce the risk of crash and injury, be prepared that the vehicle speed may reduce and the vehicle may not be able to accelerate with full power until the coolant temperature reduces.



WARNING: If you continue to drive your vehicle when the engine is overheating, the engine could stop without warning. Failure to follow this instruction could result in the loss of control of your vehicle.

You may notice a reduction in vehicle speed caused by reduced engine power in order to manage the engine coolant temperature. Your vehicle may enter this mode if certain high-temperature and high-load conditions take place. The amount of speed reduction depends on vehicle loading, grade and outside temperature. If this occurs, there is no need to stop your vehicle. You can continue to drive. See **Fail-Safe Cooling** (page 383).

The air conditioning may automatically turn on and off during severe operating conditions to protect the engine from overheating. When the coolant temperature decreases to the normal operating temperature, the air conditioning turns on.

If the coolant temperature gauge moves fully into the red zone, or if the coolant temperature warning or service engine soon messages appear in your information display, do the following:

1. Stop your vehicle as soon as it is safe to do so. Fully apply the parking brake, shift into park (P) or neutral (N).

Maintenance

2. Leave the engine running until the coolant temperature gauge needle returns to the normal position. If the temperature does not drop after several minutes, follow the remaining steps.
3. Switch the engine off and wait for it to cool. Check the coolant level.
4. If the coolant level is at or below the minimum mark, add prediluted coolant immediately.
5. If the coolant level is normal, restart the engine and continue.

COOLANT – WARNING LAMPS



If the engine begins to overheat, the coolant temperature gauge moves toward the red zone.



A warning lamp illuminates and a message may appear in the information display.

COOLANT – INFORMATION MESSAGES

Message	Description and Action
High engine temperature Stop safely	Displays when the engine temperature is too high. Stop your vehicle as soon as it is safe to do so, switch the engine off and allow it to cool. If the problem persists, have your vehicle checked as soon as possible. See Checking the Coolant Level (page 408).

CHANGING THE FUEL FILTER

Replace the fuel filter on your vehicle at the specified service interval. Refer to your scheduled maintenance information.

Maintenance

DRIVE BELT ROUTING OVERVIEW - 2.3L ECOBOOST™

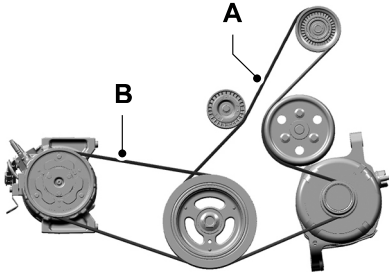

- A. Long drive belt is on the first pulley groove closest to engine.
- B. Short drive belt is on the second pulley groove farthest from engine.

DRIVE BELT ROUTING OVERVIEW - 2.7L ECOBOOST™/3.0L ECOBOOST™

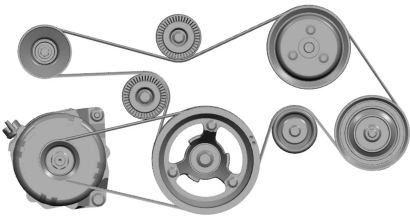

- A. Long drive belt is on the first pulley groove closest to engine.
- B. Short drive belt is on the second pulley groove farthest from engine.

12V BATTERY

12V BATTERY PRECAUTIONS

⚠ WARNING: Batteries normally produce explosive gases which can cause personal injury. Therefore, do not allow flames, sparks or lighted substances to come near the battery. When working near the battery, always shield your face and protect your eyes. Always provide correct ventilation.

⚠ WARNING: When lifting a plastic-cased battery, excessive pressure on the end walls could cause acid to flow through the vent caps, resulting in personal injury and damage to the vehicle or battery. Lift the battery with a battery carrier or with your hands on opposite corners.

⚠ WARNING: Keep batteries out of reach of children. Batteries contain sulfuric acid. Avoid contact with skin, eyes or clothing. Shield your eyes when working near the battery to protect against possible splashing of acid solution. In case of acid contact with skin or eyes, flush immediately with water for a minimum of 15 minutes and get prompt medical attention. If acid is swallowed, call a physician immediately.

⚠ WARNING: Battery posts, terminals and related accessories contain lead and lead compounds, chemicals known to the State of California to cause cancer and reproductive harm. **Wash your hands after handling.**

Maintenance



WARNING: This vehicle may have more than one battery. Removing the battery cables from only one battery does not disconnect your vehicle electrical system. Make sure you disconnect the battery cables from all batteries when disconnecting power. Failure to do so may cause serious personal injury or property damage.



WARNING: For vehicles with Auto-Start-Stop the battery requirement is different. You must replace the battery with one of exactly the same specification.

WHAT IS THE BATTERY MANAGEMENT SYSTEM

The battery management system monitors battery conditions and takes actions to extend battery life.

HOW DOES THE BATTERY MANAGEMENT SYSTEM WORK

If excessive battery drain is detected, the system temporarily disables some electrical systems to protect the battery.

Systems included are:

- Heated rear window.
- Heated seats.
- Climate control.
- Heated steering wheel.
- Audio unit.
- Navigation system.

A message could appear in the information display to alert you that battery protection actions are active. This message is only for notification that an action is taking place, and not intended to indicate an electrical problem or that the battery requires replacement.

BATTERY MANAGEMENT SYSTEM LIMITATIONS

After battery replacement, or in some cases after charging the battery with an external charger, the battery management system requires eight hours of vehicle sleep time to relearn the battery state of charge. During this time, your vehicle must remain fully locked with the ignition switched off.

Note: *Prior to relearning the battery state of charge, the battery management system could temporarily disable some electrical systems.*

Electrical Accessory Installation

To make sure the battery management system works correctly, do not connect an electrical device ground connection directly to the battery negative post. This can cause inaccurate measurements of the battery condition and potential incorrect system operation.

Note: *If you add electrical accessories or components to the vehicle, it could adversely affect battery performance and durability. This could also affect the performance of other electrical systems in the vehicle.*

CHANGING THE 12V BATTERY

The battery is in the engine compartment. See **Maintenance** (page 401).

Your vehicle has a maintenance-free battery. It does not require additional water during service.

If the vehicle battery has a cover, make sure you correctly install it after cleaning or replacing the battery.

Maintenance

For longer, trouble-free operation, keep the top of the battery clean and dry and the battery cables tightly fastened to the battery terminals. If any corrosion is present on the battery or terminals, remove the cables from the terminals and clean with a wire brush. You can neutralize the acid with a solution of baking soda and water.

We recommend that you disconnect the negative battery cable terminal from the battery if you plan to store your vehicle for an extended period.

Note: *If you only disconnect the negative battery cable terminal, make sure it is isolated or placed away from the battery terminal to avoid unintended connection or arcing.*

If you disconnect or replace the battery and your vehicle has an automatic transmission, it must relearn its adaptive strategy. Because of this, the transmission may shift firmly when first driven. This is normal operation while the transmission fully updates its operation to optimum shift feel.

Removing the Battery

1. Apply the parking brake and switch the ignition off.
2. Switch all electrical equipment off, for example lights and radio.
3. Wait a minimum of two minutes before disconnecting the battery.

Note: *The engine management system has a power hold function and remains powered for a period of time after you switch the ignition off. This is to allow diagnostic and adaptive tables to be stored. Disconnecting the battery without waiting can cause damage not covered by the vehicle Warranty.*

4. Disconnect and isolate the negative battery cable terminal.

5. Disconnect and isolate the positive battery cable terminal.
6. Remove the battery securing clamp.
7. Remove the battery.

If you disconnect or replace the vehicle battery, you must reset the following features:

- Window bounce-back. See **Window Bounce-Back** (page 109).
- Clock Settings.
- Pre-set radio stations.

Replacing the Battery

Note: *Before reconnecting the battery, make sure the ignition remains switched off.*

You must replace the battery with one of exactly the same specification.

To install, reverse the removal procedure.

Note: *Make sure that you correctly install the battery terminal covers, battery cover and battery cable terminals.*

RESETTING THE BATTERY SENSOR

When you install a new battery, reset the battery sensor by doing the following:

1. Switch the ignition on, and leave the engine off.
- Note:** *Complete Steps 2 and 3 within 10 seconds.*
2. Flash the high beam headlamps five times, ending with the high beams off.
 3. Press and release the brake pedal three times.

The battery warning lamp flashes three times to confirm that the reset is successful.

Maintenance

RECYCLING AND DISPOSING OF THE 12V BATTERY



Make sure that you dispose of old batteries in an environmentally friendly way.

Seek advice from your local authority about recycling old batteries.

12V BATTERY – TROUBLESHOOTING

12V BATTERY – WARNING LAMPS



If it illuminates while driving, it indicates a charging system error. Switch off all unnecessary electrical equipment and have your vehicle immediately checked.

12V BATTERY – INFORMATION MESSAGES

Message	Details
Check Charging System	The charging system needs servicing. If the warning stays on or continues to come on, have your vehicle checked as soon as possible.
Charging System Service Soon	The charging system needs servicing. If the warning stays on or continues to come on, have your vehicle checked as soon as possible.
Charging System Service Now	The charging system needs servicing. Have your vehicle immediately checked.

Maintenance

Message	Details
Battery State of Charge Low	The battery management system determines that the 12V battery is at a low state of charge. Start the engine to charge the battery or charge the battery using an aftermarket battery charger. Always use the vehicle ground point when connecting the negative cable of the external battery charger. See Jump Starting the Vehicle (page 378). This message clears once you restart your vehicle and the battery state of charge has recovered. Do not switch on the ignition when a battery charger is in use to charge the battery.
Turn Power Off To Save Battery	The battery management system determines that the battery is at a low state of charge. Turn the ignition off as soon as possible to protect the battery. This message will clear once the vehicle has been started and the battery state of charge has recovered. Turning off unnecessary electrical loads will allow faster battery state-of-charge recovery.
Electrical Power Saver Active Some Features Turned Off See Manual	Displayed when the battery management system detects an extended low-voltage condition. Various vehicle features will be disabled to help preserve the battery. Turn off as many of the electrical loads as soon as possible to improve system voltage. If the system voltage has recovered, the disabled features will operate again as normal.

ADJUSTING THE HEADLAMPS

Vertical Aim Adjustment

The headlamps on your vehicle are properly aimed at the assembly plant. If your vehicle has been in an accident, contact an authorized dealer to check and realign your headlamps.

Headlamp Aiming Target

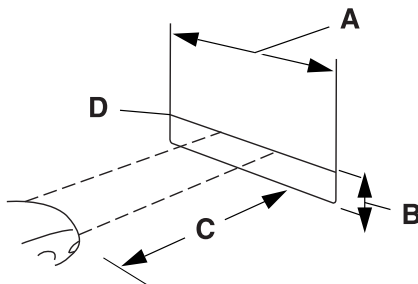

- A 15 feet (4.5 m).
- B Center height of lamp to ground.
- C 35 feet (10 m).
- D B height minus 100 mm.

Maintenance

1. Park your vehicle directly in front of a wall or screen on a level surface, approximately 35 ft (10 m) away.
2. Measure height from the center of the low beam to the ground and, from this measurement, deduct 4 in (10cm) and add a reference line 15 ft (4.5 m) wide on vertical wall or screen at this height. A piece of masking tape works well.
3. Switch on the low beam headlamps to illuminate the wall or screen and open the hood. Cover one of the headlamps so no light hits the wall.



4. On the wall or screen, observe a light pattern with a distinct horizontal edge toward the right. If this edge is not at the horizontal reference line, adjust the beam so the edge is at the same height as the horizontal reference line.



5. Locate the vertical adjuster on each headlamp. Use a screwdriver to turn the adjuster either counterclockwise or clockwise to adjust the vertical aim of the headlamp.
6. Repeat Steps 3 through 7 to adjust the other headlamp.
7. Close the hood and switch off the headlamps.

Horizontal Aim Adjustment

Horizontal aim is not required for this vehicle and is not adjustable.

EXTERIOR BULBS

EXTERIOR BULB SPECIFICATION CHART

Replacement bulbs are specified in the chart below. The correct bulbs will not damage the lamp assembly or void the lamp assembly warranty and provide quality bulb illumination time.

Lamp	Specification	Power (Watt)
Center high mounted cargo lamp. Vehicles with pickup box.	LED	LED
Daytime running lamp (If equipped).	Low Series - H18	Low Series - 21W

Maintenance

Lamp	Specification	Power (Watt)
	Mid and High Series - LED	Mid and High Series - LED
Front position lamp.	Low - W5W Mid and High - LED	Low - 5W Mid and High - LED
Front turn signal.	Low and Mid Series - WY28/8W High Series - LED	Mid and Low Series - 28W High Series - LED
Front fog lamp.	Low Series - H11 Mid and High Series - LED	Low Series - 55W Mid and High Series - LED
Headlamp low beam.	Low Series - H18 Mid and High Series - LED	Low Series - 55W Mid and High Series - LED
Headlamp high beam.	Low Series - HB3 Mid and High Series - LED	Low Series - 65W Mid and High Series - LED
License plate lamp.	Low Series - W5W Mid and High Series - LED	Low Series - 5W Mid and High Series - LED
Puddle lamp.	LED	LED
Rear cargo box lamp.	LED	LED
Rear turn signal.	Low and Mid Series - WY21W High Series - LED	Low and Mid Series - 21W High Series - LED
Rear lamp, stop lamp.	Low Series - W21/5W Mid and High Series - LED	Low Series - 21W Mid and High Series - LED
Rear position lamp.	Low Series - W21/5W Mid and High Series - LED	Low Series - 5W Mid and High Series - LED
Reversing lamp.	Low and Mid Series - W21W High Series - LED	Low and Mid Series - 21W High Series - LED

Note: LED lamps are not serviceable. See an authorized dealer if they fail.

Maintenance

REMOVING A REAR LAMP ASSEMBLY

1. Make sure the headlamps and rear lamps are off.
2. Open the tailgate to access the rear lamp assemblies.

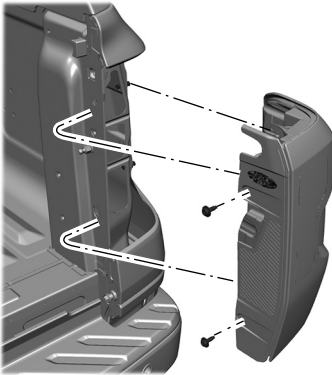

3. Remove the two bolts from the tail lamp assembly. Carefully pull the lamp assembly from the tailgate pillar.
4. Disconnect the electrical connector from the bulb.
5. To install, reverse the removal procedure.

CHANGING A HEADLAMP BULB



WARNING: Make sure the bulbs have cooled down before removing them. Failure to follow this warning could result in serious personal injury.

Accessing and Replacing the Low Beam Headlamp Bulbs

1. Make sure the headlamps are off.
2. Remove the scrivet from the modesty panel.

3. Remove the modesty panel section.

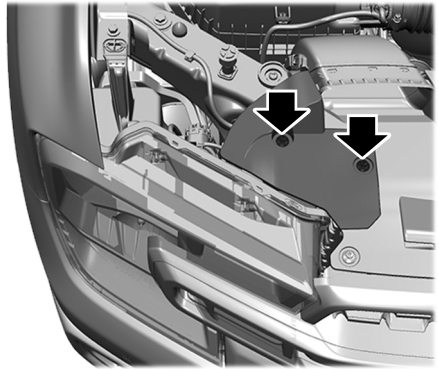

4. Remove the scrivet from the front fender and the hardware from the bolster.

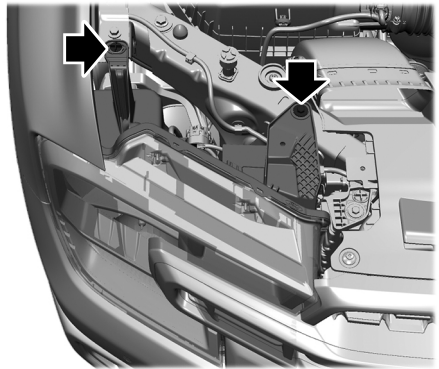

5. Using a screwdriver loosen, but do not remove, the three screws by turning them two full turns.

Maintenance

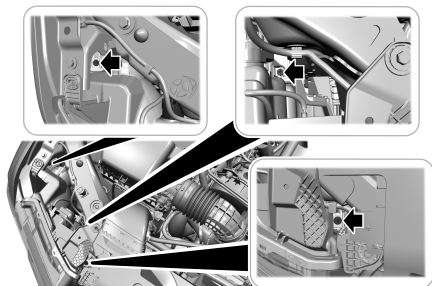

6. Carefully slide the headlamp assembly forward approximately 1.2 in (30 mm), do not remove the headlamp. Be careful of the sharp fender edge, as it could damage the headlamp.

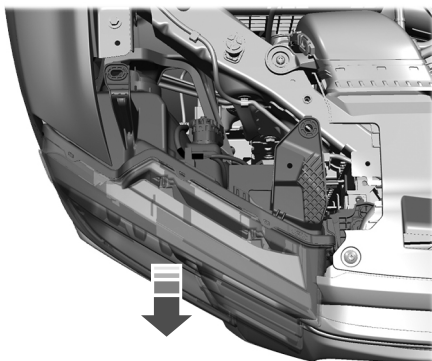

7. Rotate the low beam bulb cap counterclockwise and remove it from the vehicle.

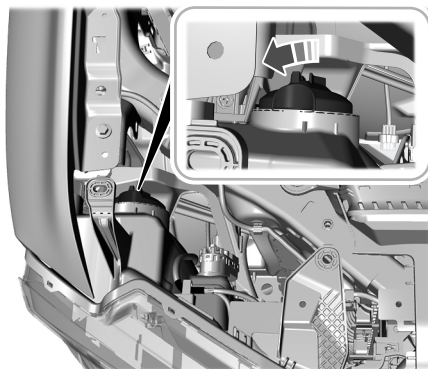

8. Disconnect the electrical connector from the bulb.
9. Place your hand behind the headlamp and push the retainer toward the lamp and down.
10. Move the bulb retainer away from the bulb and remove the bulb.

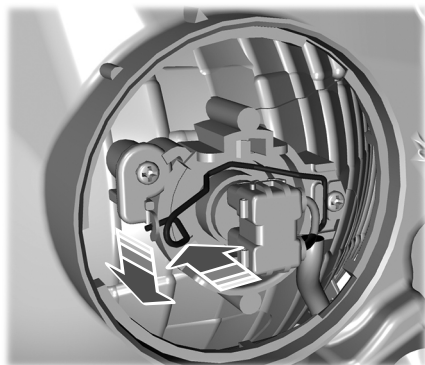

11. To install the bulb, reverse the removal steps.

Maintenance

Note: Handle a halogen headlamp bulb carefully and keep out of children's reach. Handle the bulb only by its plastic base and do not touch the glass. The oil from your hand could cause the bulb to break the next time the headlamps are operated.

Note: If the bulb is accidentally touched, clean it with rubbing alcohol before installing it.

Accessing and Replacing the High Beam Headlamp Bulbs

1. Make sure the headlamps are off.
2. Remove the scrivet from the modesty panel.
3. Remove the modesty panel section.

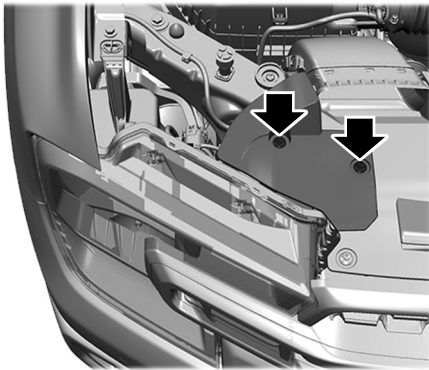

4. Remove the scrivet from the front fender and the hardware from the bolster.

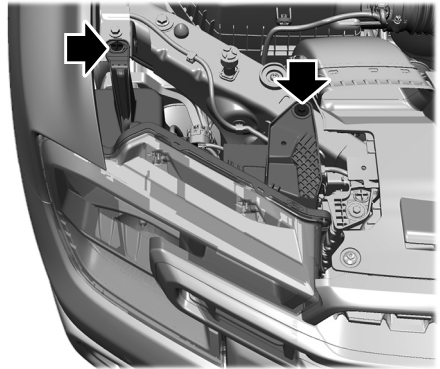

5. Using a screwdriver loosen, but do not remove, the three screws by turning them two full turns.

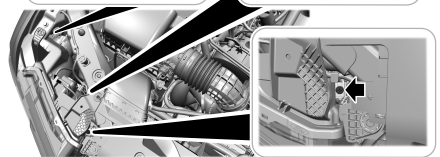
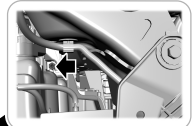
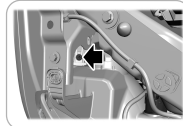

6. Carefully slide the headlamp assembly forward approximately 1.2 in (30 mm), do not remove the headlamp. Be careful of the sharp fender edge, as it could damage the headlamp.

Maintenance

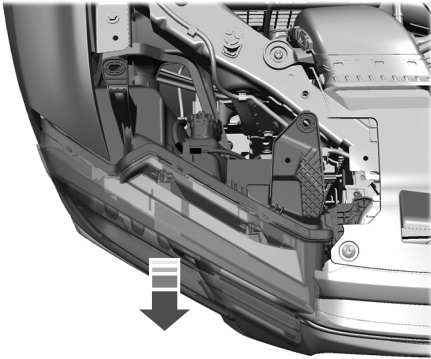

7. Reach into the space below the low beam socket.

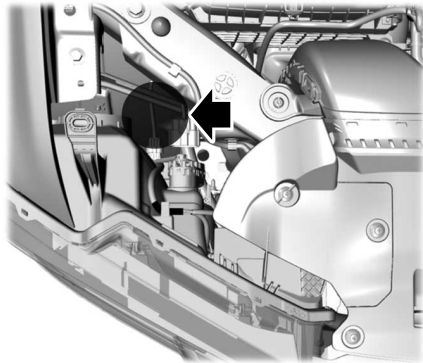

8. Disconnect the electrical connector from the bulb.
9. Rotate the high beam bulb socket counterclockwise and remove the high beam bulb.

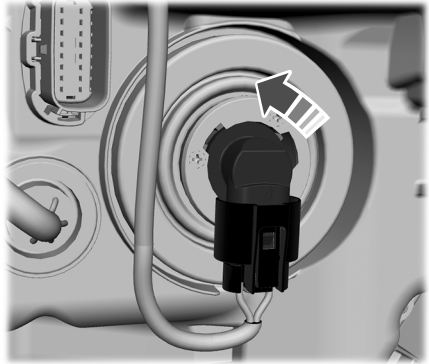

10. To install the bulb, reverse the removal steps.

Note: Handle a halogen headlamp bulb carefully and keep out of children's reach. Handle the bulb only by its plastic base and do not touch the glass. The oil from your hand could cause the bulb to break the next time the headlamps are operated.

Note: If the bulb is accidentally touched, clean it with rubbing alcohol before installing it.

CHANGING A FRONT TURN SIGNAL LAMP BULB



WARNING: Make sure the bulbs have cooled down before removing them. Failure to follow this warning could result in serious personal injury.

Changing a Front Turn Signal Lamp Bulb with Halogen Headlamps

1. Make sure the headlamps and the front turn signal lamps are off.
2. Remove the scrivet from the modesty panel.
3. Remove the modesty panel section.

Maintenance

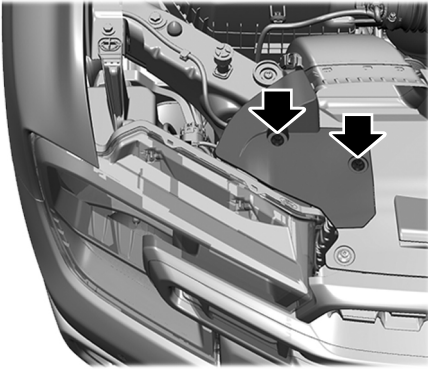

4. Reach behind the headlamp assembly and rotate the bulb socket counterclockwise to remove it from the headlamp assembly.
5. Remove the bulb from the socket.

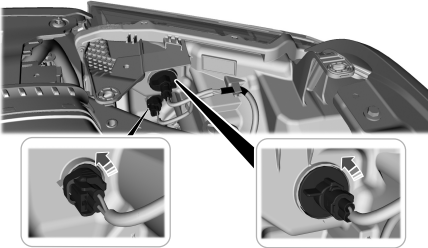

6. To install the bulb, reverse the removal steps.

Changing a Front Turn Signal Lamp Bulb with Mid Level Headlamps

1. Make sure the headlamps and the front turn signal lamps are off.
2. Remove the scrivet from the modesty panel.
3. Remove the modesty panel section.

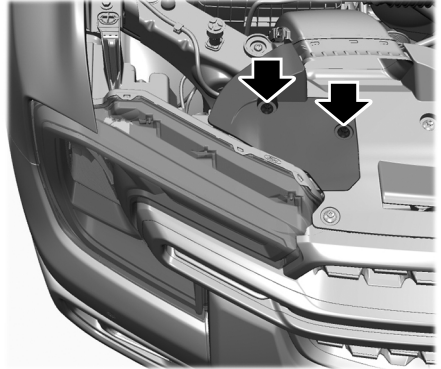

4. Rotate the low beam bulb cap counterclockwise and remove it from the headlamp assembly.

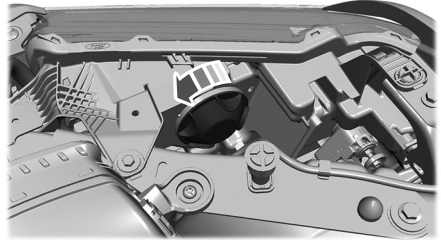

5. Reach behind the headlamp assembly and rotate the bulb socket counterclockwise to remove it from the headlamp assembly.
6. Remove the bulb from the socket.

Maintenance

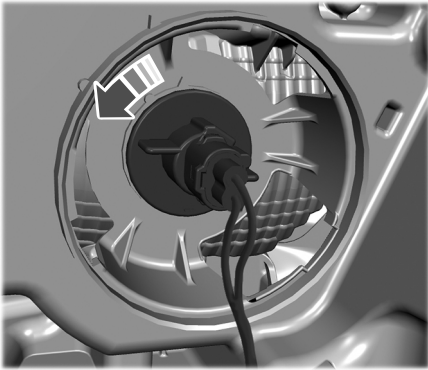

7. To install the bulb, reverse the removal steps.

CHANGING A FRONT FOG LAMP BULB

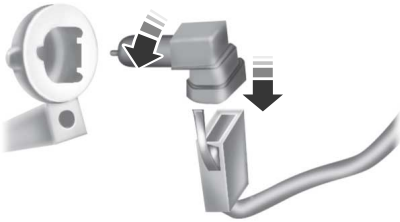

1. Make sure the fog lamps are off.
2. Disconnect the electrical connector from the fog lamp bulb.
3. Turn the bulb counterclockwise and remove it from the fog lamp.
4. To install, reverse the removal procedure.

CHANGING A REAR LAMP BULB

Low Series

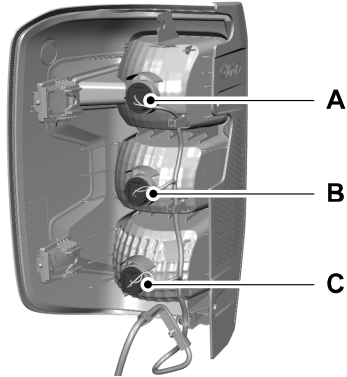

- A Tail lamp and stop lamp bulb.
- B Turn signal bulb.
- C Reverse bulb.

Mid Series

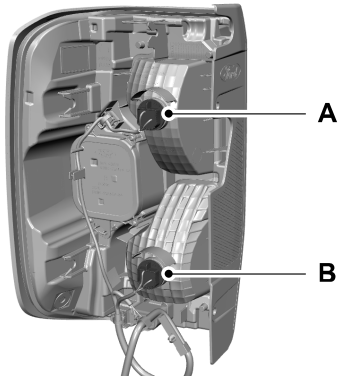

- A Turn signal bulb.
- B Reverse bulb.

Maintenance

1. Remove the rear lamp assembly. See **Removing a Rear Lamp Assembly** (page 419).
2. Rotate the bulb socket counterclockwise and remove it from the rear lamp assembly.
3. Remove the bulb from the bulb socket.
4. To install, reverse the removal procedure.

INTERIOR BULBS

INTERIOR BULB SPECIFICATION CHART

Your vehicle has LED lamps. These are not serviceable items. See an authorized dealer if they fail.

Vehicle Care

CLEANING THE EXTERIOR

CLEANING THE EXTERIOR PRECAUTIONS

Immediately remove fuel spillages, additive residuals, bird droppings, insect deposits and road tar. These may cause damage to your vehicle's paintwork or trim over time. Remove any exterior accessories, for example antennas, before entering a car wash.

CLEANING HEADLAMPS AND REAR LAMPS

We recommend that you only use cold or lukewarm water containing car shampoo to clean the headlamps and the rear lamps.

Do not scrape the lamps.

Do not wipe lamps when they are dry.

CLEANING WINDOWS AND WIPER BLADES

To clean the windshield and wiper blades:

- Clean the windshield with a non-abrasive glass cleaner.

Note: *When cleaning the interior of the windshield, avoid getting any glass cleaner on the instrument panel or door panels. Wipe any glass cleaner off these surfaces immediately.*

- Clean the wiper blades with washer fluid or water applied with a soft sponge or cloth.

Note: *Do not use razor blades or other sharp objects to clean or remove decals from the inside of the heated rear window. This can cause damage not covered by the vehicle Warranty.*

Note: *We recommend cleaning the power sliding rear window at regular intervals to avoid dust and debris accumulation to deliver appropriate function.*

CLEANING CHROME, ALUMINIUM OR STAINLESS STEEL

We recommend that you only use a car shampoo, a soft cloth and water on bumpers and other chrome, aluminium or stainless steel parts.

Note: *For additional information and assistance, we recommend that you contact an authorized dealer.*

Note: *Rinse the area well after cleaning.*

Note: *Do not use abrasive materials, for example steel wool or plastic pads, as they can scratch these surfaces.*

Note: *Do not use chrome cleaner, metal cleaner or polish on wheels or wheel covers.*

CLEANING WHEELS

Only use a recommended wheel and tire cleaner to clean the wheels weekly. For additional information and assistance, we recommend that you contact an authorized dealer.

1. Use a sponge to remove heavy deposits of dirt and brake dust.
2. Rinse well after cleaning.

Note: *Do not apply a cleaning chemical to warm or hot wheel rims and covers.*

If you intend on parking your vehicle for an extended period after cleaning the wheels with a wheel cleaner, drive your vehicle for a few minutes before parking your vehicle. This reduces the risk of corrosion of the brake discs, brake pads and linings.

Do not clean the wheels when they are hot.

Note: *Some car washes could damage wheel rims and covers.*

Vehicle Care

Note: *Using non-recommended cleaners, harsh cleaning products, chrome wheel cleaners or abrasive materials could damage wheel rims and covers.*

CLEANING THE ENGINE COMPARTMENT

Use a vacuum cleaner to remove debris from the screen area below windshield.

Note: *If you are not familiar with the parts around the engine do not wash the engine compartment. Avoid frequent engine washes.*

When washing the engine compartment:

- Never wash or rinse the engine while it is hot or running.
- Never wash or rinse any ignition coil, spark plug wire or spark plug well.
- Cover the battery, power distribution box, and air filter assembly to prevent water damage.

Note: *If your vehicle has an engine cover remove the cover before application of shampoo and degreaser.*

- Spray an approved engine shampoo and degreaser on all parts that require cleaning and rinse with water.

CLEANING STRIPES OR GRAPHICS

It is recommended to wash your vehicle by hand however, pressure washing may be used under the following conditions:

- Use a spray with a 40° wide spray angle pattern.
- Keep the nozzle at a 12 in (30 cm) distance and 90° angle to your vehicle's surface.

- Do not use water pressure higher than 1,450 psi (10,000 kPa).
- Do not use water hotter than 167°F (75°C).

Note: *Holding the pressure washer nozzle at an angle to the vehicle's surface may damage graphics and cause the edges to peel away from the vehicle's surface.*

CLEANING CAMERA LENSES AND SENSORS

We recommend that you only use lukewarm or cold water and a soft cloth to clean the camera lens and sensors.

Note: *Do not pressure wash camera lens and sensors.*

CLEANING THE UNDERBODY

Flush the complete underside of your vehicle frequently. Keep body and door drain holes free from packed dirt.

Rear suspension components and the complete underbody will require regular cleaning with a power washer or a thorough rinse with a strong stream of water if the vehicle is operated in coastal areas, dusty or muddy environments. Rear leaf springs or other suspension components may emit squeaking or popping noises while operating the vehicle if particles, such as dirt, rocks, or other debris, are present in the components.

Vehicle Care

CLEANING THE INTERIOR

CLEANING THE INSTRUMENT PANEL



WARNING: Do not use chemical solvents or strong detergents when cleaning the steering wheel or instrument panel to avoid contamination of the airbag system.

We recommend that you only clean the instrument panel and cluster lens with a damp soft cloth. Dry the area with a clean, soft cloth.

For additional information and assistance, we recommend that you contact an authorized dealer.

Note: *Avoid cleaners or polishes that increase the gloss of the upper portion of the instrument panel. The dull finish in this area helps protect you from undesirable windshield reflection.*

CLEANING PLASTIC

We recommend that you only use a mild soap and water solution on a soft cloth. Dry the area with a clean, soft cloth.

CLEANING DISPLAYS AND SCREENS

We recommend that you only use a microfiber cloth in a circular motion to clean off the fingerprint or dust.

If dirt or fingerprints are still on the screen, apply a small amount of alcohol to the cloth and try to clean it again.

Note: *Do not pour or spray alcohol onto the touchscreen.*

Note: *Do not use detergent or any type of solvent to clean the touchscreen.*

CLEANING FABRIC



WARNING: On vehicles equipped with seat-mounted airbags, do not use chemical solvents or strong detergents. Such products could contaminate the side airbag system and affect performance of the side airbag in a crash.

We recommend that you only clean fabric in the following way:

1. Remove dust and loose dirt with a vacuum cleaner.
2. Wipe the surface with a soft, damp cloth and a mild soap and water solution. Dry the area with a clean, soft cloth.
3. For additional information and assistance, we recommend that you contact an authorized dealer.

For heavy stains, spot clean the area. If a ring forms on the fabric, clean the entire area immediately, but do not oversaturate or the ring could set.

CLEANING LEATHER



WARNING: On vehicles equipped with seat-mounted airbags, do not use chemical solvents or strong detergents. Such products could contaminate the side airbag system and affect performance of the side airbag in a crash.

We recommend that you only clean the leather surfaces in the following way:

1. Remove dust and loose dirt with a vacuum cleaner.
2. Wipe the surface with a soft, damp cloth and a mild soap and water solution. Dry the area with a clean, soft cloth.

Vehicle Care

3. Make sure the leather is dry, then apply a small amount of conditioner to a clean, dry cloth.
 4. Rub the conditioner into the leather until it disappears. Allow the conditioner to dry, then repeat the process for the entire interior. If a film appears, wipe it off with a dry, clean cloth.
 5. For additional information and assistance, we recommend that you contact an authorized dealer.
2. Wipe the surface with a soft, damp cloth and a mild soap and water solution. Dry the area with a clean, soft cloth.
 3. For additional information and assistance, we recommend that you contact an authorized dealer.

For heavy stains, spot clean the area. If a ring forms on the fabric, clean the entire area immediately, but do not oversaturate or the ring could set.

We recommend that you only clean your floor mats in the following way:

1. Remove dust and loose dirt with a vacuum cleaner.
2. Wash rubber floor mats using mild soap and lukewarm or cold water.
3. Completely dry the floor mat before placing them back in your vehicle.

CLEANING VINYL



WARNING: On vehicles equipped with seat-mounted airbags, do not use chemical solvents or strong detergents. Such products could contaminate the side airbag system and affect performance of the side airbag in a crash.

We recommend that you only clean vinyl surfaces in the following way:

1. Remove dust and loose dirt with a vacuum cleaner.
2. Wipe the surface with a soft, damp cloth and a mild soap and water solution. Dry the area with a clean, soft cloth.
3. For additional information and assistance, we recommend that you contact an authorized dealer.

CLEANING SEATBELTS



WARNING: Do not use cleaning solvents, bleach or dye on the vehicle's seatbelts, as these actions may weaken the belt webbing.

1. Wipe the surface with a soft, damp cloth and a mild soap and water solution. Dry the area with a clean, soft cloth.

CLEANING CARPETS AND FLOOR MATS

We recommend that you only clean your carpets in the following way:

1. Remove dust and loose dirt with a vacuum cleaner.

REPAIRING MINOR PAINT DAMAGE

We recommend that you contact an authorized dealer to identify your vehicle color code. Authorized dealers have touch-up paint to match your vehicle's color.

Vehicle Care

Before repairing minor paint damage, use a cleaner to remove particles such as bird droppings, tree sap, insect deposits, tar spots, road salt and industrial fallout.

Read the instructions before using cleaning products.

WAXING YOUR VEHICLE

Wax the high-gloss painted surface of your prewashed vehicle once or twice a year.

We recommend that you only use an approved quality wax that does not contain abrasives. Follow the manufacturer's instructions to apply and remove the wax. For additional information and assistance, we recommend that you contact an authorized dealer.

When washing and waxing, park your vehicle in a shaded area out of direct sunlight.

Note: *Avoid waxing unpainted or low-gloss black colored parts, they discolor over time.*

Storing Your Vehicle

PREPARING YOUR VEHICLE FOR STORAGE

If you plan on storing your vehicle for 30 days or more, the following maintenance recommendations ensures your vehicle stays in good operating condition.

Under various conditions, long-term storage may lead to degraded engine performance or failure unless you use specific precautions to preserve your vehicle.

General

- Store all vehicles in a dry, ventilated place.
- If vehicles are stored outside, they require regular maintenance to protect against rust and weather damage.
- Make sure all linkages, cables, levers and pins under your vehicle are covered with grease to prevent rust.
- Move vehicles at least 25 ft (7.5 m) every 15 days to lubricate working parts and prevent corrosion.
- Fill the fuel tank with high-quality fuel until the first automatic shutoff of the fuel pump nozzle.

Engine

- Change the engine oil and filter prior to storage because used engine oil contains contaminants which may cause engine damage.
- Start the engine every 15 days for a minimum of 15 minutes. Run at fast idle with the climate controls set to defrost until the engine reaches normal operating temperature.
- With your foot on the brake, shift through all the gears while the engine is running.

Body

- Wash your vehicle thoroughly to remove dirt, grease, oil, tar or mud from exterior surfaces, rear wheel housings and the underside of front fenders.
- Periodically wash your vehicle if it is stored in exposed locations.
- Touch-up exposed or primed metal to prevent rust.
- Cover chrome and stainless steel parts with a thick coat of auto wax to prevent discoloration. Rewax as necessary when you wash your vehicle.
- Lubricate all hood, door and luggage compartment hinges and latches with a light grade oil.
- Cover interior trim to prevent fading.
- Keep all rubber parts free from oil and solvents.

12 Volt Battery

- When storing your vehicle for longer than 30 days the state of charge should be approximately 50%. Additionally, we recommend to disconnect the 12v battery to reduce system loads on the battery, or you can use a trickle charger for longer storage periods.
- Check and recharge as necessary. Keep connections clean.

Note: *It is necessary to reset memory features if you disconnect the battery cables.*

Storing Your Vehicle

Tires

- Maintain recommended air pressure.
- To minimize flat spots on the tires, inflate all four tires to the recommended cold pressures listed on the Safety Compliance Certification label or Tire Label affixed to your vehicle. When the vehicle is taken out of storage, reset the tire pressures as necessary to the recommended levels listed on the Safety Compliance Certification label or Tire Label affixed to your vehicle.

Note: *If you store your vehicle in a location with low ambient temperatures, follow the instructions for care of summer tires.*

Brakes

Make sure the brakes and parking brake fully release.

Note: *If you intend on parking your vehicle for an extended period after cleaning the wheels with a wheel cleaner, drive your vehicle for a few minutes before doing so to reduce the risk of increased corrosion of the brake discs, brake pads and linings.*

- Check the exhaust for any foreign materials.
- Check tire pressures and set tire inflation per the Tire Label.
- Check brake pedal operation. Corroded brake rotors could cause brake noise. Drive your vehicle and gently apply and release the brakes repeatedly over a 10-minute drive to reduce the corrosion from the brakes.
- Check fluid levels (including coolant, oil and gas) to make sure there are no leaks, and fluids are at recommended levels.
- If you remove the battery, clean the battery cable ends and check for damage.

Contact an authorized dealer if you have any concerns or issues.

REMOVING YOUR VEHICLE FROM STORAGE

When your vehicle is ready to come out of storage, do the following:

- We recommend that you change the engine oil before you use your vehicle again.
- Wash your vehicle to remove any dirt or grease film build-up on window surfaces.
- Check windshield wipers for any deterioration.
- Check the underhood for any foreign materials such as mice or squirrel nests.

Wheel and Tire Information

LOCATING THE TIRE LABEL

The tire label or safety certification label is on the driver side B-pillar or the edge of the driver door. It contains information on the recommended front and rear tire inflation pressures.

DEPARTMENT OF TRANSPORTATION UNIFORM TIRE QUALITY GRADES



Tire Quality Grades apply to new pneumatic passenger car tires. The Quality grades can be found where applicable on the tire sidewall between tread shoulder and maximum section width. For example: **Treadwear 200 Traction AA Temperature A.**

These Tire Quality Grades are determined by standards that the United States Department of Transportation has set.

Tire Quality Grades apply to new pneumatic passenger car tires. They do not apply to deep tread, winter-type snow tires, space-saver or temporary use spare tires, light truck or LT type tires, tires with nominal rim diameters of 10 to 12 inches or limited production tires as defined in Title 49 Code of Federal Regulations Part 575.104 (c)(2).

U.S. Department of Transportation Tire quality grades: The U.S. Department of Transportation requires us to give you the following information about tire grades exactly as the government has written it.

Treadwear

The treadwear grade is a comparative rating based on the wear rate of the tire when tested under controlled conditions on a specified government test course. For example, a tire graded 150 would wear 1½ times as well on the government course as a tire graded 100. The relative performance of tires depends upon the actual conditions of their use, however, and may depart significantly from the norm due to variations in driving habits, service practices, and differences in road characteristics and climate.

Wheel and Tire Information

Traction AA A B C



WARNING: The traction grade assigned to this tire is based on straight-ahead braking traction tests, and does not include acceleration, cornering, hydroplaning or peak traction characteristics.

The traction grades, from highest to lowest are AA, A, B, and C. The grades represent the tire's ability to stop on wet pavement as measured under controlled conditions on specified government test surfaces of asphalt and concrete. A tire marked C may have poor traction performance.

Temperature A B C



WARNING: The temperature grade for this tire is established for a tire that is properly inflated and not overloaded. Excessive speed, underinflation, or excessive loading, either separately or in combination, can cause heat buildup and possible tire failure.

The temperature grades are A (the highest), B and C, representing the tire's resistance to the generation of heat and its ability to dissipate heat when tested under controlled conditions on a specified indoor laboratory

test wheel. Sustained high temperature can cause the material of the tire to degenerate and reduce tire life, and excessive temperature can lead to sudden tire failure. The grade C corresponds to a level of performance which all passenger car tires must meet under the Federal Motor Vehicle Safety Standard No. 139. Grades B and A represent higher levels of performance on the laboratory test wheel than the minimum required by law.

INFORMATION ON THE TIRE SIDEWALL

Both United States and Canada Federal regulations require tire manufacturers to place standardized information on the sidewall of all tires. This information identifies and describes the fundamental characteristics of the tire and also provides a U.S. DOT Tire Identification Number for safety standard certification and in case of a recall.

Wheel and Tire Information

Information on P Type Tires

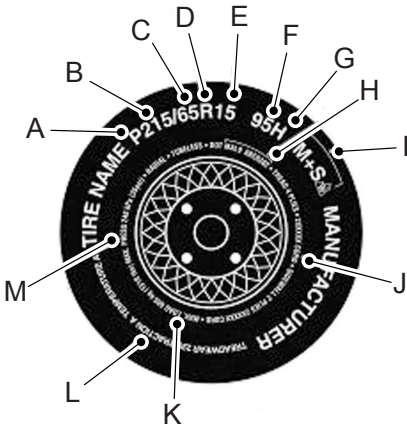

P215/65R15 95H is an example of a tire size, load index and speed rating. The definitions of these items are listed below. (Note that the tire size, load index and speed rating for your vehicle may be different from this example.)

A. P: Indicates a tire, designated by the Tire and Rim Association, that may be used for service on cars, sport utility vehicles, minivans and light trucks. **Note:** If your tire size does not begin with a letter this may mean it is designated by either the European Tire and Rim Technical Organization or the Japan Tire Manufacturing Association.

B. 215: Indicates the nominal width of the tire in millimeters from sidewall edge to sidewall edge. In general, the larger the number, the wider the tire.

C. 65: Indicates the aspect ratio which gives the tire's ratio of height to width.

D. R: Indicates a radial type tire.

E. 15: Indicates the wheel or rim diameter in inches. If you change your wheel size, you will have to purchase new tires to match the new wheel diameter.

F. 95: Indicates the tire's load index. It is an index that relates to how much weight a tire can carry. You may find this information in your owner's manual. If not, contact a local tire dealer.

Note: *You may not find this information on all tires because it is not required by federal law.*

G. H: Indicates the tire's speed rating. The speed rating denotes the speed at which a tire is designed to be driven for extended periods of time under a standard condition of load and inflation pressure. The tires on your vehicle may operate at different conditions for load and inflation pressure. These speed ratings may need to be adjusted for the difference in conditions. The ratings range from 81 mph (130 km/h) to 186 mph (299 km/h). These ratings are listed in the following chart.

Wheel and Tire Information

Note: You may not find this information on all tires because it is not required by federal law.

Letter rating	Speed rating
M	81 mph (130 km/h)
N	87 mph (140 km/h)
Q	99 mph (159 km/h)
R	106 mph (171 km/h)
S	112 mph (180 km/h)
T	118 mph (190 km/h)
U	124 mph (200 km/h)
H	130 mph (210 km/h)
V	149 mph (240 km/h)
W	168 mph (270 km/h)
Y	186 mph (299 km/h)

Note: For tires with a maximum speed capability over 149 mph (240 km/h), tire manufacturers sometimes use the letters ZR. For those with a maximum speed capability over 186 mph (299 km/h), tire manufacturers always use the letters ZR.

H. U.S. DOT Tire Identification Number (TIN): This begins with the letters DOT and indicates that the tire meets all federal standards. The next two numbers or letters are the plant code designating where it was manufactured, the next two are

the tire size code and the last four numbers represent the week and year the tire was built. For example, the numbers 317 mean the 31st week of 1997. After 2000, the numbers go to four digits. For example, 2501 means the 25th week of 2001. The numbers in between are identification codes used for traceability. This information is used to contact customers if a tire defect requires a recall.

I. M+S or M/S: Mud and Snow, or
AT: All Terrain, or
AS: All Season.

J. Tire Ply Composition and Material Used: Indicates the number of plies or the number of layers of rubber-coated fabric in the tire tread and sidewall. Tire manufacturers also must indicate the ply materials in the tire and the sidewall, which include steel, nylon, polyester, and others.

K. Maximum Load: Indicates the maximum load in kilograms and pounds that can be carried by the tire. See the Safety Compliance Certification Label (affixed to either the door hinge pillar, door-latch post, or the door edge that meets the door-latch post, next to the driver's seating position), for the correct tire pressure for your vehicle.

L. Treadwear, Traction and Temperature Grades:

Wheel and Tire Information

***Treadwear:** The treadwear grade is a comparative rating based on the wear rate of the tire when tested under controlled conditions on a specified government test course. For example, a tire graded 150 would wear one and one-half times as well on the government course as a tire graded 100.

***Traction:** The traction grades, from highest to lowest are AA, A, B, and C. The grades represent the tire's ability to stop on wet pavement as measured under controlled conditions on specified government test surfaces of asphalt and concrete. A tire marked C may have poor traction performance.

***Temperature:** The temperature grades are A (the highest), B and C, representing the tire's resistance to the generation of heat and its ability to dissipate heat when tested under controlled conditions on a specified indoor laboratory test wheel.

M. Maximum Inflation Pressure: Indicates the tire manufacturers' maximum permissible pressure or the pressure at which the maximum load can be carried by the tire. This pressure is normally higher than the vehicle manufacturer's recommended cold inflation pressure which can be found on the Safety Compliance Certification Label (affixed to either the door hinge pillar,

door-latch post, or the door edge that meets the door-latch post, next to the driver's seating position), or Tire Label which is located on the B-Pillar or the edge of the driver's door. The cold inflation pressure should never be set lower than the recommended pressure on the vehicle label.

The tire suppliers may have additional markings, notes or warnings such as standard load or radial tubeless.

Additional Information Contained on the Tire Sidewall for LT Type Tires

Note: *Tire Quality Grades do not apply to this type of tire.*

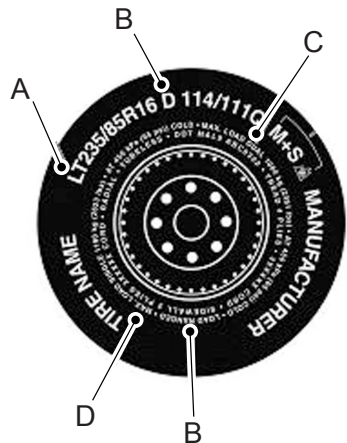

Wheel and Tire Information

LT type tires have some additional information beyond those of P type tires; these differences are described below.

A. **LT:** Indicates a tire, designated by the Tire and Rim Association, that is intended for service on light trucks.

B. **Load Range and Load Inflation Limits:** Indicates the tire's load-carrying capabilities and its inflation limits.

C. **Maximum Load Dual lb (kg) at psi (kPa) cold:** Indicates the maximum load and tire pressure when the tire is used as a dual, defined as four tires on the rear axle (a total of six or more tires on the vehicle).

D. **Maximum Load Single lb (kg) at psi (kPa) cold:** Indicates the maximum load and tire pressure when the tire is used as a single, defined as two tires (total) on the rear axle.

Information on T Type Tires

T145/80D16 is an example of a tire size.

Note: *The temporary tire size for your vehicle may be different from this example. Tire Quality Grades do not apply to this type of tire.*

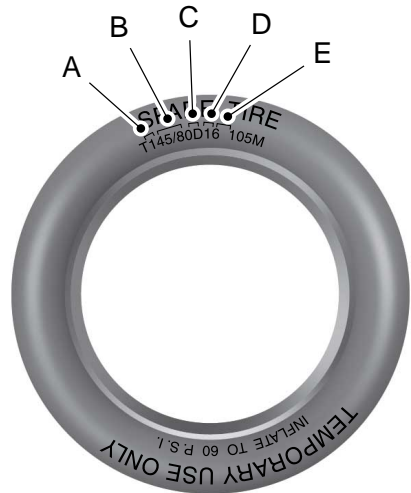

T type tires have some additional information beyond those of P type tires; these differences are described below:

A. **T:** Indicates a type of tire, designated by the Tire and Rim Association, that is intended for temporary service on cars, sport utility vehicles, minivans and light trucks.

B. **145:** Indicates the nominal width of the tire in millimeters from sidewall edge to sidewall edge. In general, the larger the number, the wider the tire.

Wheel and Tire Information

C. **80:** Indicates the aspect ratio which gives the tire's ratio of height to width. Numbers of 70 or lower indicate a short sidewall.

D. **D:** Indicates a diagonal type tire.

R: Indicates a radial type tire.

E. **16:** Indicates the wheel or rim diameter in inches. If you change your wheel size, you will have to purchase new tires to match the new wheel diameter.

GLOSSARY OF TIRE TERMINOLOGY

***Tire label:** A label showing the original equipment tire sizes, recommended inflation pressure and the maximum weight the vehicle can carry.

***Tire Identification Number (TIN):** A number on the sidewall of each tire providing information about the tire brand and manufacturing plant, tire size and date of manufacture. Also referred to as DOT code.

***Inflation pressure:** A measure of the amount of air in a tire.

***Standard load:** A class of P-metric or Metric tires designed to carry a maximum load at set pressure. For example: For P-metric tires 35 psi (2.4 bar) and for Metric tires 36 psi (2.5 bar). Increasing the inflation pressure beyond this pressure will not increase the tire's load carrying capability.

***Extra load:** A class of P-metric or Metric tires designed to carry a heavier maximum load at 42 psi (2.9 bar). Increasing the inflation pressure beyond this pressure will not increase the tire's load carrying capability.

***kPa:** Kilopascal, a metric unit of air pressure.

***PSI:** Pounds per square inch, a standard unit of air pressure.

***Cold tire pressure:** The tire pressure when the vehicle has been stationary and out of direct sunlight for an hour or more and prior to the vehicle being driven for 1 mi (1.6 km).

***Recommended inflation pressure:** The cold inflation pressure found on the Safety Compliance Certification Label (affixed to either the door hinge pillar, door-latch post, or the door edge that meets the door-latch post, next to the driver's seating position), or Tire Label located on the B-Pillar or the edge of the driver door.

* **B-pillar:** The structural member at the side of the vehicle behind the front door.

***Bead area of the tire:** Area of the tire next to the rim.

* **Sidewall of the tire:** Area between the bead area and the tread.

Wheel and Tire Information

***Tread area of the tire:** Area of the perimeter of the tire that contacts the road when mounted on the vehicle.

***Rim:** The metal support (wheel) for a tire or a tire and tube assembly upon which the tire beads are seated.

TIRE REPLACEMENT REQUIREMENTS

AGE



WARNING: Tires degrade over time depending on many factors such as weather, storage conditions, and conditions of use (load, speed, inflation pressure) the tires experience throughout their lives.

In general, tires should be replaced after six years regardless of tread wear. However, heat caused by hot climates or frequent high loading conditions can accelerate the aging process and may require tires to be replaced more frequently.

You should replace your spare tire when you replace the road tires or after six years due to aging even if it has not been used.

U.S. DOT Tire Identification Number

Both United States and Canada Federal regulations require tire manufacturers to place standardized information on the sidewall of all tires. This information identifies and describes the fundamental characteristics of the tire and also provides a U.S. DOT Tire Identification Number for safety standard certification and in case of a recall.

This begins with the letters DOT and indicates that the tire meets all federal standards. The next two numbers or letters are the plant code designating where it was manufactured, the next two are the tire size code and the last four numbers represent the week and year the tire was built. For example, the numbers 317 mean the 31st week of 1997. After 2000, the numbers go to four digits. For example, 2501 means the 25th week of 2001. The numbers in between are identification codes used for traceability. This information is used to contact customers if a tire defect requires a recall.

Tire Replacement Requirements

Your vehicle is equipped with tires designed to provide a safe ride and handling capability.

Wheel and Tire Information



WARNING: Only use replacement tires and wheels that are the same size, load index, speed rating, and type as those originally provided for your vehicle. The recommended tire and wheel sizes can be found on the Tire Label on the driver side door frame or the edge of the driver door. If this information is not found in those locations, or for additional options, contact your authorized dealer. Use of any tire or wheel not recommended, could affect the safety and performance of your vehicle, which could result in an increased risk of loss of vehicle control, vehicle rollover, personal injury and death.



WARNING: To reduce the risk of serious injury, when mounting replacement tires and wheels, you should not exceed the maximum pressure indicated on the sidewall of the tire to set the beads without additional precautions listed below. If the beads do not seat at the maximum pressure indicated, re-lubricate and try again.



WARNING: For a mounting pressure more than 20 psi (1.38 bar) greater than the maximum pressure, a Ford dealer or other tire service professional should do the mounting.



WARNING: Always inflate steel carcass tires with a remote air fill with the person inflating standing at a minimum of 12 ft (3.66 m) away from the wheel and tire assembly.



WARNING: When inflating the tire for mounting pressures up to 20 psi (1.38 bar) greater than the maximum pressure on the tire sidewall, the following precautions must be taken to protect the person mounting the tire:

- Make sure that you have the correct tire and wheel size.
- Lubricate the tire bead and wheel bead seat area again.
- Stand at a minimum of 12 ft (3.66 m) away from the wheel and tire assembly.
- Use both eye and ear protection.

Important: Remember to replace the wheel valve stems when the road tires are replaced on your vehicle.

It is recommended that the two front tires or two rear tires generally be replaced as a pair if the worn tires still have usable depth.

Wheel and Tire Information

To avoid potential Four-Wheel Drive (4WD) malfunction or (4WD) system damage, it is recommended to replace all four tires rather than mixing significantly worn tires with new tires.

The tire pressure sensors mounted in the wheels (originally installed on your vehicle) are not designed to be used in aftermarket wheels.

The use of wheels or tires not recommended may affect the operation of your tire pressure monitoring system.

If the tire pressure monitoring system indicator is flashing, your system is malfunctioning. Your replacement tire might be incompatible with your tire pressure monitoring system, or some component of the system may be damaged.

USING SNOW CHAINS - EXCLUDING: RAPTOR



WARNING: Do not exceed 30 mph (50 km/h). Failure to follow this instruction could result in the loss of control of your vehicle, personal injury or death.



WARNING: Do not use snow chains on snow-free roads.



WARNING: Only fit snow chains to specified tires.



WARNING: If your vehicle is fitted with wheel trims, remove them before fitting snow chains.



WARNING: If you choose to install snow tires on your vehicle, they must be the same size, construction, and load range as the original tires listed on the tire placard, and they must be installed on all four wheels. Mixing tires of different size or construction on your vehicle can adversely affect your vehicle's handling and braking, and may lead to loss of vehicle control.

Only use snow chains on rear wheels. Install snow chains in pairs. Do not use self-tensioning snow chains.

Only use snow chains on the following specified tire sizes. Only use S-class snow chains, 15mm chain links.

- 255/70R16
- 255/70R17
- 255/65R18
- LT255/70R17

We recommend you use steel wheels of the same size and specification if snow chains are required because chains may chip aluminum wheels.

Follow these guidelines when using snow tires and traction devices:

- If possible, avoid fully loading your vehicle.
- Purchase snow chains from a manufacturer that clearly labels body to tire dimension restrictions.
- When driving with snow chains do not exceed 30 mph (50 km/h) or the maximum speed recommended by the chain manufacturer, whichever is less.

Wheel and Tire Information

- Drive cautiously. If you hear the snow chains rub or bang against the vehicle, stop and tighten them. If this does not work, remove the snow chains to prevent vehicle damage.
- Remove the snow chains when they are no longer needed. Do not use snow chains on dry roads.
- If a temporary spare wheel is mounted on your vehicle, do not use snow chains on the axle with the temporary spare wheel.

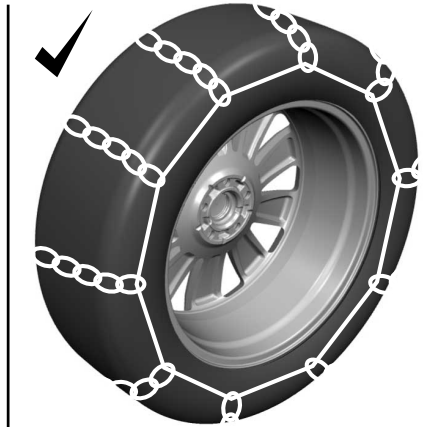
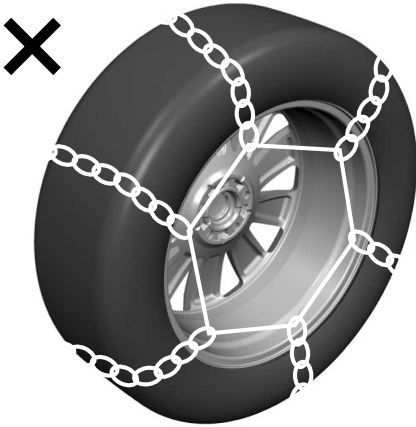

Use snow chains that fit against the sidewall of the tire to prevent the chains from touching the wheel rims or suspension. Refer to the previous illustration.

If you have any questions regarding snow chains, contact your authorized dealer.

USING SNOW CHAINS - RAPTOR

WARNING: Do not exceed 30 mph (50 km/h). Failure to follow this instruction could result in the loss of control of your vehicle, personal injury or death.

WARNING: Do not use snow chains on snow-free roads.

WARNING: Only fit snow chains to specified tires.

WARNING: If your vehicle is fitted with wheel trims, remove them before fitting snow chains.

Wheel and Tire Information



WARNING: If you choose to install snow tires on your vehicle, they must be the same size, construction, and load range as the original tires listed on the tire placard, and they must be installed on all four wheels. Mixing tires of different size or construction on your vehicle can adversely affect your vehicle's handling and braking, and may lead to loss of vehicle control.

Only use snow chains on rear wheels. Install snow chains in pairs. Do not use self-tensioning snow chains.

Only use snow chains on the following specified tire sizes. Only use S-class snow chains, 15mm chain links.

- LT285/70R17

We recommend you use steel wheels of the same size and specification if snow chains are required because chains may chip aluminum wheels.

Follow these guidelines when using snow tires and traction devices:

- If possible, avoid fully loading your vehicle.
- Purchase snow chains from a manufacturer that clearly labels body to tire dimension restrictions.
- When driving with snow chains do not exceed 30 mph (50 km/h) or the maximum speed recommended by the chain manufacturer, whichever is less.
- Drive cautiously. If you hear the snow chains rub or bang against the vehicle, stop and tighten them. If this does not work, remove the snow chains to prevent vehicle damage.
- Remove the snow chains when they are no longer needed. Do not use snow chains on dry roads.
- If a temporary spare wheel is mounted on your vehicle, do not use snow chains on the axle with the temporary spare wheel.

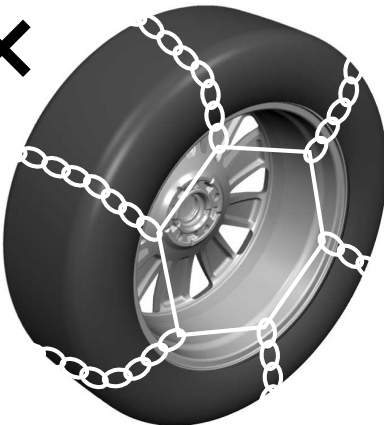

Wheel and Tire Information

Use snow chains that fit against the sidewall of the tire to prevent the chains from touching the wheel rims or suspension. Refer to the previous illustration.

If you have any questions regarding snow chains, contact your authorized dealer.

USING BEAD-LOCK WHEELS - RAPTOR

Your vehicle comes with unique wheels matched to the tires. To avoid damage to your wheels:

- Maintain proper tire pressure.
- Due to extreme tire and wheel width, do not take your vehicle through an automatic car wash that uses mechanical tracks, as wheel damage may result.
- When installing wheels, always torque lug nuts to specification with a torque wrench.
- Inspect your wheels for damage on a regular basis. If you have a damaged wheel, replace it immediately.
- If you encounter an abnormally harsh impact, inspect the outside tire wall of your wheels, both inside and out, for damage.

Note: *Ford Performance only recommends using bead-lock rings from Ford Performance Parts, in conjunction with the original equipment manufacturer (OEM) tire. Any other combination using this wheel could result in air loss or tire failure.*

Note: *Converting the bead-lock compatible wheel to true bead-locks is for off-road use only. We do not approve of the use of true bead-locks for on-road driving.*

If your vehicle has the optional bead lock compatible wheel, you can convert this wheel to use a true bead-lock ring, which allows operation at low tire pressures when off-road to minimize the risk of de-beading the tire. See your local Ford Performance Parts Dealer for more information.

Tire Care



WARNING: Always re-inflate tires to recommended tire pressures before the vehicle is operated on-road. The recommended pressure is located on the tire label or safety certification label, located on the B-pillar, inside the driver's door.



WARNING: After off-road use, before returning to the road, check the wheels and tires for damage. Off-road use may cause damage to your wheels and tires that can lead to tire failure, loss of vehicle control, serious injury or death.



WARNING: Replace the wheels and tires with the exact original brand, size and construction that came originally on your vehicle. Use of any other wheel or tire combinations, even with identical size ratings, may result in insufficient running clearances, tire rubbing and eventual puncture. Failure to follow tire replacement recommendations can lead to tire failure, loss of vehicle control, serious injury or death.

Note: *If you have reduced your tire pressure for off-road use, the tire pressure monitoring system (TPMS) warning light then activates in the instrument panel as a reminder to re-inflate the tires before returning to the road.*

Wheel and Tire Information

Your vehicle comes with high performance, all-terrain tires designed to optimize handling, steering and braking to provide the performance you expect in a Ford Performance vehicle. These tires are optimized for both on and off-road performance, and their ride, noise and wear characteristics are different from other tires. Also, because of their aggressive tread profile, it is important that you maintain your tires properly.

- Always maintain your tire pressures according to the tire information placard located on the driver's door B-pillar, using an accurate gauge. Remember to be prepared to re-inflate your tires before returning to the road. If a tire filling station is not available, remember to prepare a supplemental means to inflate the tires, such as a portable compressor.
- Check and set the tire pressures when the tires are cold, and not warm from driving. Wait at least three hours after parking the vehicle before checking tire pressure. Do not reduce the pressure of warm tires.
- Check your tire pressure often to properly maintain it. Tire pressure can decrease over time and fluctuate with temperature.
- Do not overload your vehicle. Maximum vehicle and axle weights are on the tire information placard.
- Use extra caution when operating your vehicle near its maximum load, including making sure your vehicle's tires are at the proper tire pressure and reducing speed.
- If you encounter an abnormally harsh impact, inspect your tires for damage.
- Inspect your tires for damage on a regular basis. Immediately replace a damaged tire.

- We do not approve the use of snow chains on your vehicle's tires.
- Proper suspension alignment is critical for maximum performance and optimal tire wear. If you notice uneven tire wear, have your alignment checked.

Spare Tire and Wheel

Your vehicle comes with a full size matching spare with an all-terrain tire. The spare tire and wheel assembly has the same capability as the road tire and wheel assemblies but does not come with a tire pressure monitoring sensor.

Tires	Wheels
LT285/70R17	17x8.5, 34 ET

Tire Care

CHECKING THE TIRE PRESSURES

Safe operation of your vehicle requires that your tires are properly inflated. Check your tire pressure everyday before driving your vehicle.

At least once a month and before long trips, inspect each tire and check the tire pressure with a tire gauge. Inflate all tires to the recommended inflation pressure. See **Inflating the Tires** (page 447).

INFLATING THE TIRES



WARNING: Under-inflation is the most common cause of tire failures and may result in severe tire cracking, tread separation or blowout, with unexpected loss of vehicle control and increased risk of injury. Under-inflation increases sidewall flexing and rolling resistance, resulting in heat buildup and internal damage to the tire. It also may result in unnecessary tire stress, irregular wear, loss of vehicle control and accidents. A tire can lose up to half of its air pressure and not appear to be flat!



WARNING: Do not use the tire pressure displayed in the information display as a tire pressure gauge. Failure to follow this instruction could result in personal injury or death.

Use the recommended cold inflation pressure for optimum tire performance and wear. Under-inflation or over-inflation may cause uneven tread wear patterns.

Inflate your tires to the recommended inflation pressure even if it is less than the maximum inflation pressure information found on the tire. You can find the tire label with the recommended tire inflation pressure next to the tire size on the B-pillar or the edge of the driver door.

The recommended tire inflation pressure is also found on the Safety Compliance Certification Label, affixed to either the door hinge pillar, door latch post, or the door edge that meets the door latch on the B-pillar, or on the edge of the driver door.

Failure to follow the tire pressure recommendations can cause uneven tread wear patterns and adversely affect the way your vehicle handles.

Tire Care

When temperature changes occur, tire inflation pressures also change. A 6°C or 10°F temperature drop can cause a corresponding drop of 1.0 psi (7 kPa) in inflation pressure. Check your tire pressure frequently and adjust them to the proper pressure which can be found on the Safety Compliance Certification Label or Tire Label.

INSPECTING THE TIRE FOR WEAR

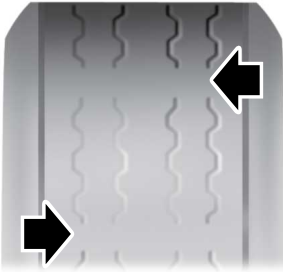

When the tread is worn down to 2/32 inch (1.6 mm), tires must be replaced to help prevent your vehicle from skidding and hydroplaning. Built-in treadwear indicators, or wear bars, which look like narrow strips of smooth rubber across the tread will appear on the tire when the tread is worn down to 2/32 inch (1.6 mm).

When the tire tread wears down to the same height as these wear bars, the tire is worn out and must be replaced.

The tires should also be balanced periodically. An unbalanced tire and wheel assembly may result in irregular tire wear.

Periodically inspect the tire treads for uneven or excessive wear and remove objects such as stones, nails or glass that may be wedged in the tread grooves.

INSPECTING THE TIRE FOR DAMAGE



WARNING: Do not scrub the sidewalls of the tires when you are parking.

Inspect the tire sidewalls for cracking, cuts, bruises and other signs of damage or excessive wear. If internal damage to the tire is suspected, have the tire dismantled and inspected in case it needs to be repaired or replaced. For your safety, tires that are damaged or show signs of excessive wear should not be used because they are more likely to blow out or fail.

Tire Care

Periodically inspect the tire treads and sidewalls for damage, such as bulges in the tread or sidewalls, cracks in the tread groove and separation in the tread or sidewall. If damage is observed or suspected, have the tire inspected by a tire professional.

Tire Wear

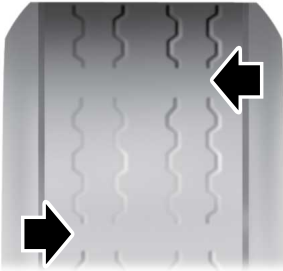

When the tread is worn down to 1/16 in (2 mm), tires must be replaced to help prevent your vehicle from skidding and hydroplaning. Built-in tread wear indicators, or wear bars, which look like narrow strips of smooth rubber across the tread appear when the tread is worn down to 1/16 (2 mm).

When the tire tread wears down to the same height as these wear bars, the tire is worn out and must be replaced.

Damage

Periodically inspect the tire treads and sidewalls for damage such as bulges in the tread or sidewalls, cracks in the tread groove and separation in the tread or sidewall. If damage is observed or suspected have the tire inspected by a tire professional. Tires can be damaged during off-road use, so inspection after off-road use is also recommended.

Age



WARNING: Tires degrade over time depending on many factors such as weather, storage conditions, and conditions of use (load, speed, inflation pressure) the tires experience throughout their lives.



WARNING: In general, tires should be replaced after six years regardless of tread wear. However, heat caused by hot climates or frequent high loading conditions can accelerate the aging process and may require tires to be replaced more frequently.



WARNING: You should replace your spare tire when you replace the road tires or after six years due to aging even if it has not been used.

Tire Care

Safety Practices



WARNING: If your vehicle is stuck in snow, mud or sand, do not rapidly spin the tires; spinning the tires can tear the tire and cause an explosion. A tire can explode in as little as three to five seconds.



WARNING: Do not spin the wheels at over 34 mph (55 km/h). The tires may fail and injure a passenger or bystander.

Highway Hazards

No matter how carefully you drive, there is always the possibility that you could eventually have a flat tire on the highway. Drive slowly to the closest safe area out of traffic. This could further damage the flat tire, but your safety is more important.

If you feel a sudden vibration or ride disturbance while driving, or you suspect your tire or vehicle has been damaged, immediately reduce your speed. Drive with caution until you can safely pull off the road. Stop and inspect the tires for damage. If a tire is under-inflated or damaged, deflate it, remove the wheel and replace it with your spare tire and wheel. If you cannot detect a cause, have the vehicle towed to the nearest repair facility or tire dealer to have the vehicle inspected.

Tire and Wheel Alignment

A bad jolt from hitting a curb or pothole can cause the front end of your vehicle to become misaligned or cause damage to your tires. If your vehicle seems to pull to one side when you are driving, the wheels could be out of alignment. Have an authorized dealer check the wheel alignment periodically.

Wheel misalignment in the front or the rear can cause uneven and rapid tread wear of your tires and should be corrected by an authorized dealer.

INSPECTING THE WHEEL VALVE STEMS

Check the valve stems for holes, cracks, or cuts that could permit air leakage.

TIRE ROTATION



WARNING: If the tire label shows different tire pressures for the front and rear tires and the vehicle has a tire pressure monitoring system, then you need to update the settings for the system sensors. Always

Tire Care

perform the system reset procedure after tire rotation. If you do not reset the system, it may not provide a low tire pressure warning when necessary.

Rotating your tires at the recommended interval will help your tires wear more evenly, providing better tire performance and longer tire life.

Note: *If your tires show any uneven wear have the alignment checked by an authorized dealer before rotating tires.*

Note: *If you have a dissimilar spare wheel and tire assembly, it is intended for temporary use only and should not be used in a tire rotation.*

Note: *After having your tires rotated, inflation pressure must be checked and adjusted to the vehicle requirements.*

Tire Rotation Diagram

Follow the diagram indicating the correct tire locations for rotating the tires.

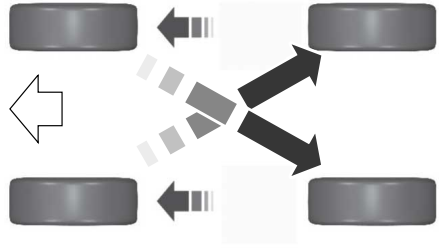

Tire Pressure Monitoring System

WHAT IS THE TIRE PRESSURE MONITORING SYSTEM



The tire pressure monitoring system measures the vehicle's tire pressures. A warning lamp illuminates if one or more tires are significantly underinflated or if there is a system malfunction.

TIRE PRESSURE MONITORING SYSTEM OVERVIEW



WARNING: Under-inflation is the most common cause of tire failures and may result in severe tire cracking, tread separation or blowout, with unexpected loss of vehicle control and increased risk of injury. Under-inflation increases sidewall flexing and rolling resistance, resulting in heat buildup and internal damage to the tire. It also may result in unnecessary tire stress, irregular wear, loss of vehicle control and accidents. A tire can lose up to half of its air pressure and not appear to be flat!



WARNING: To determine the required pressure(s) for your vehicle, see the Safety Compliance Certification Label (on the door hinge pillar, door-latch post or the door edge that meets the door-latch post, next to the driver seat) or the Tire Label on the B-Pillar or the edge of the driver door.

Each tire, including the spare (if provided), should be checked monthly when cold and inflated to the inflation pressure recommended by the vehicle manufacturer on the vehicle placard or tire inflation pressure label. (If your vehicle has tires of a different size than the size indicated on the vehicle placard or tire inflation pressure label, you should determine the proper tire inflation pressure for those tires).

As an added safety feature, your vehicle has been equipped with a Tire Pressure Monitoring System (TPMS) that illuminates a low tire pressure telltale when one or more of your tires is significantly under-inflated. Accordingly, when the low tire pressure telltale illuminates, you should stop and check your tires as soon as possible, and inflate them to the proper pressure. Driving on a significantly under-inflated tire causes the tire to overheat and can lead to tire failure. Under-inflation also reduces fuel efficiency and tire tread life, and may affect the vehicle's handling and stopping ability.

Please note that the TPMS is not a substitute for proper tire maintenance, and it is the driver's responsibility to maintain correct tire pressure, even if under-inflation has not reached the level to trigger illumination of the TPMS low tire pressure telltale.

Your vehicle has also been equipped with a TPMS malfunction indicator to indicate when the system is not operating properly. The TPMS malfunction indicator is combined with the low tire pressure telltale. When the system detects a malfunction, the telltale will flash for approximately one minute and then remain continuously illuminated. This sequence will continue upon subsequent vehicle start-ups as long as the malfunction exists.

Tire Pressure Monitoring System

When the malfunction indicator is illuminated, the system may not be able to detect or signal low tire pressure as intended. TPMS malfunctions may occur for a variety of reasons, including the installation of replacement or alternate tires or wheels on the vehicle that prevent the TPMS from functioning properly. Always check the TPMS malfunction telltale after replacing one or more tires or wheels on your vehicle to ensure that the replacement or alternate tires and wheels allow the TPMS to continue to function properly.



WARNING: Changes or modifications not expressly approved by the party responsible for compliance could void the user's authority to operate the equipment. The term "IC:" before the radio certification number only signifies that Industry Canada technical specifications were met.

This device complies with Part 15 of the FCC Rules and with License exempt RSS Standards of Industry Canada. Operation is subject to the following two conditions:

1. This device may not cause harmful interference, and
2. This device must accept any interference received, including interference that may cause undesired operation.

TIRE PRESSURE MONITORING SYSTEM PRECAUTIONS



WARNING: The tire pressure monitoring system is not a substitute for manually checking tire pressures. You should periodically check tire pressures using a pressure gauge. Failure to correctly maintain tire pressures could increase the risk of tire failure, loss of control, vehicle rollover and personal injury.



WARNING: Do not use the tire pressure displayed in the information display as a tire pressure gauge. Failure to follow this instruction could result in personal injury or death.

Note: *The use of tire sealants can damage the tire pressure monitoring system.*

Note: *If the tire pressure monitor sensor becomes damaged it may not function.*

TIRE PRESSURE MONITORING SYSTEM LIMITATIONS

When the outside temperature drops significantly, the tire pressure could decrease and activate the low tire pressure warning lamp.

The warning lamp could also illuminate when you use a spare wheel, or tire sealant from the inflator kit.

Note: *Regularly checking the vehicle tire pressures can reduce the possibility for the warning lamp to illuminate due to outside air temperature changes.*

Note: *After you inflate the tires to the recommended pressure it could take up to two minutes of driving over 20 mph (32 km/h) for the warning indicator to turn off.*

Tire Pressure Monitoring System

VIEWING THE TIRE PRESSURES



To view the current tire pressures, use the information display or touchscreen.

TIRE PRESSURE MONITORING SYSTEM – TROUBLESHOOTING

TIRE PRESSURE MONITORING SYSTEM – WARNING LAMPS



The low tire pressure warning lamp has combined functions, as it warns you when your tires need air, and when the system is no longer capable of functioning as intended.

Warning Lamp	Possible Cause	Action Required
Solid warning lamp	One or more tires are significantly under inflated	After inflating your tires to the manufacturer's recommended pressure as shown on the tire label, on the edge of driver door or the B-pillar, drive your vehicle for at least two minutes over 20 mph (32 km/h) before the light turns off.
Solid warning lamp or flashing warning lamp	Temporary spare wheel in use	Repair the damaged road wheel and refit it to your vehicle to restore operation of the system.
	Tire pressure monitoring system malfunction	If the tires are inflated to the recommended tire pressures and the temporary spare wheel is not in use, the system detected a fault that requires service. Have your vehicle checked as soon as possible.

Tire Pressure Monitoring System

TIRE PRESSURE MONITORING SYSTEM – INFORMATION MESSAGES

Message	Action
Tire Pressure Low	After inflating your tires to the manufacturer's recommended pressure as shown on the tire label, on the edge of the driver door or the B-pillar, drive your vehicle for at least two minutes over 20 mph (32 km/h) before the light turns off.
Tire Pressure Monitor Fault	The system has detected a fault that requires service. Have your vehicle checked as soon as possible.
Tire Pressure Sensor Fault	The system has detected a fault that requires service or a spare tire is in use. Have your vehicle checked as soon as possible.

Changing a Road Wheel

CHANGING A FLAT TIRE - EXCLUDING: RAPTOR

If you get a flat tire when driving, do not apply the brake heavily. Instead, gradually decrease your speed, hold the steering wheel firmly and slowly move to a safe place on the side of the road.

Have the flat serviced by an authorized dealer to prevent damage to the system sensors. See **Tire Pressure Monitoring System Precautions** (page 453). Replace the spare tire with a road tire as soon as possible. During repairing or replacing the flat tire, have the authorized dealer inspect the system sensor for damage.

Note: *The use of tire sealant could damage your tire pressure monitoring system and should only be used in roadside emergencies.*

Note: *The tire pressure monitoring system indicator light illuminates when the spare tire is in use. To restore the full function of the monitoring system, all road wheels equipped with tire pressure monitoring sensors must be mounted on this vehicle.*

Dissimilar Spare Wheel and Tire Assembly Information



WARNING: Failure to follow these guidelines could result in an increased risk of loss of vehicle control, injury or death.



WARNING: If you are not sure what type of spare wheel your vehicle has, do not exceed 50 mph (80 km/h).

If the spare wheel is different from the other fitted road wheels, it may have a warning label with the appropriate maximum speed limit. Drive cautiously when using a dissimilar spare wheel and tire assembly.

Full-size Dissimilar Spare Wheel With a Label on the Wheel

The label on the wheel states: Appropriate max speed limits.

A dissimilar spare wheel and tire is for temporary use only. Drive the shortest distance possible and have the damaged road wheel and tire repaired or replaced as soon as possible. If the dissimilar spare wheel or tire is damaged, it must be replaced.

If you use a dissimilar spare wheel and tire assembly, this can lead to impairment of the following:

- Handling, stability and braking performance.
- Comfort and noise.
- Ground clearance and parking at curbs.
- Winter weather driving capability.
- Wet weather driving capability.
- All wheel driving capability.

When driving with this type of a dissimilar spare wheel:

- Do not exceed the maximum speed as shown on the label.
- Do not load your vehicle beyond maximum vehicle load rating listed on the safety compliance label.
- Do not tow a trailer.
- Do not use snow chains on the end of your vehicle with the dissimilar spare.
- Do not use more than one dissimilar spare tire at a time.
- Do not use a commercial car wash.

Changing a Road Wheel

Tire Change Procedure

WARNING: To help prevent your vehicle from moving when changing a wheel, shift the transmission into park (P), set the parking brake and use an appropriate block or wheel chock to secure the wheel diagonally opposite to the wheel being changed. For example, when changing the front left wheel, place an appropriate block or wheel chock on the right rear wheel.

WARNING: The jack supplied with this vehicle is only intended for changing a flat tire in an emergency. Do not attempt to do any other work on your vehicle when it is supported by the jack, as your vehicle could slip off the jack. Failure to follow this instruction could result in personal injury or death.

WARNING: Do not attempt to change a tire on the side of the vehicle close to moving traffic. Pull far enough off the road to not obstruct the flow of traffic and avoid the danger of being hit when operating the jack or changing the wheel.

WARNING: Only use the jack provided as original equipment with your vehicle.

WARNING: Do not get under a vehicle that is supported by a jack.

WARNING: No person should place any portion of their body under a vehicle that is supported by a jack.

WARNING: Ensure screwthread is adequately lubricated before use.

WARNING: The jack should be used on level firm ground wherever possible.

WARNING: Never place anything between the vehicle jack and the ground.

WARNING: Never place anything between the vehicle jack and your vehicle.

WARNING: It is recommended that the wheels of the vehicle be chocked, and that no person should remain in a vehicle that is being jacked.

WARNING: Make sure that your vehicle is on firm and level ground with the front wheels pointing straight ahead and set up a warning triangle if available.

WARNING: If you are not sure what type of spare wheel your vehicle has, do not exceed 50 mph (80 km/h).

1. Park the vehicle on a level, firm surface and activate the hazard flashers.
2. Apply parking brake, turn the engine off.

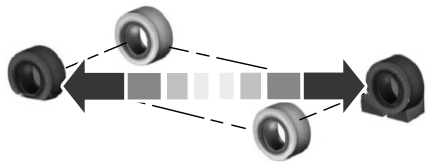

Changing a Road Wheel

3. Block the wheel diagonally opposite the flat tire. For example, if the left front tire is flat, block the right rear wheel.

Note: *Passengers should not remain in the vehicle when the vehicle is being jacked.*

Removing the Vehicle Jack and Tool Bag

The jack, wheel brace and jack handle are located in the cab.

Note: *Not all cab configurations are available in all markets.*

Super Cab

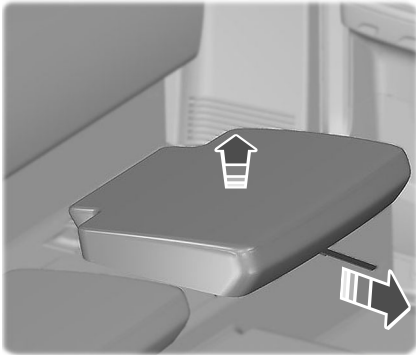

1. Pull the release strap.
2. Remove the rear seats.

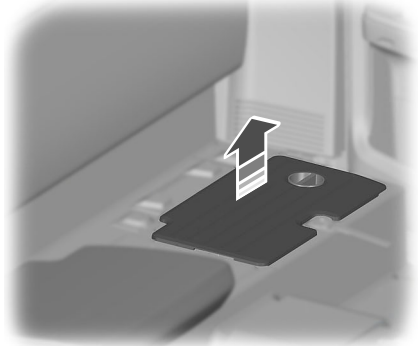

3. Remove the cover.

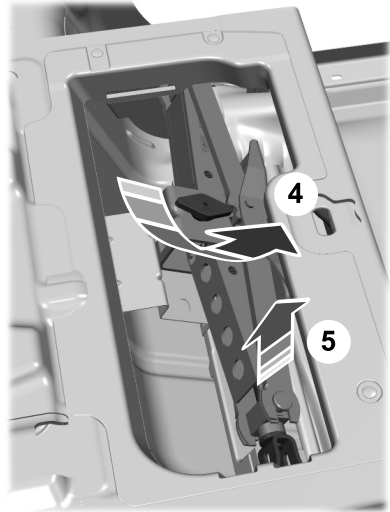

4. Remove the bolt.
5. Lift the jack from the foam block and remove the jack from your vehicle.
6. Remove the tools.

Changing a Road Wheel

Double Cab

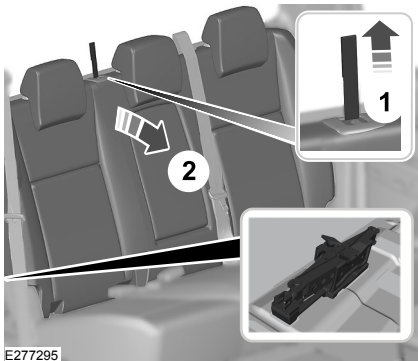

1. Lift the release strap.
2. Lower the seat back.
3. Remove the bolt.
4. Lift the jack from the foam block and remove the jack from your vehicle.

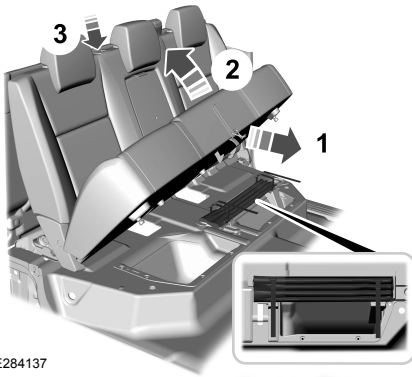

1. Pull the release strap out.
2. Lift the seat bottom up.
3. Use the tether strap to secure the seat cushion.

4. Locate tool bag and remove the securing straps.

Removing the Spare Tire

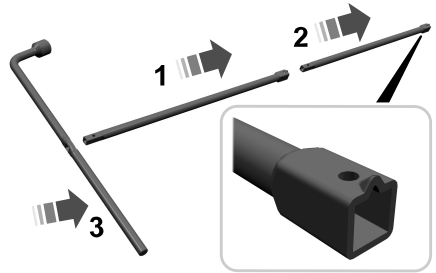

1. Assemble the handle.

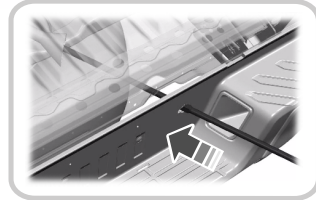
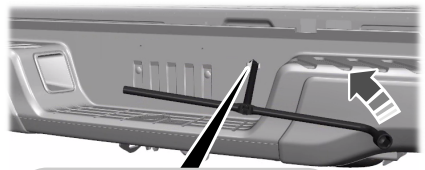

2. Insert the jack handle into the guide hole. Turn counterclockwise until the wheel rests on the ground, and there is slack in the cable.

Changing a Road Wheel

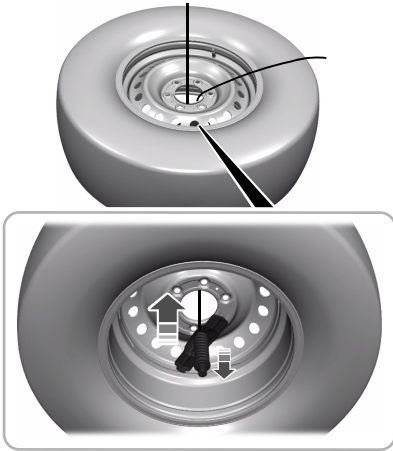

3. Pass the bracket and cable through the wheel opening.

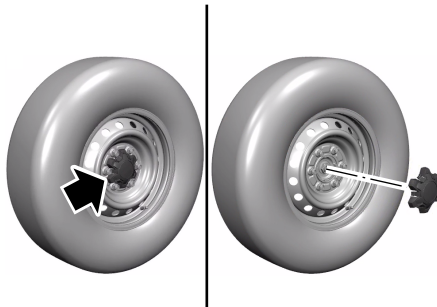

4. Vehicles with steel wheels, remove the center cap by pulling off or using an object to pry the cover off. Loosen each wheel lug nut one-half turn counterclockwise, but do not remove them until the wheel is raised off the ground.

5. Vehicles with aluminum wheels, loosen each wheel lug nut one-half turn counterclockwise, but do not remove them until the wheel is raised off the ground.

Note: If the spare wheel is not the same type and size as your vehicle road wheel, drive the shortest distance possible.

Note: Do not fit more than one spare wheel on your vehicle at any one time.

Note: Using a dissimilar spare wheel or tire at any one wheel location can compromise the handling, stability and braking performance, comfort and noise.

Note: When driving with a spare tire, do not switch on four-wheel drive mode unless you need to get your vehicle unstuck.

Note: The spare wheel is located underneath the rear of the vehicle.

Note: Do not use power tools on the spare wheel winch input drive.

Changing a Road Wheel

Removing a Road Wheel



WARNING: Only use the specified jacking points. If you use any other locations you could damage vehicle components, such as brake lines.

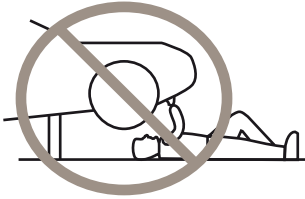

Note: No maintenance or additional lubrication of your jack is required over the service life of your vehicle.

Note: Jack at the specified locations to avoid damage to the vehicle.

Note: Only use the jack on the specified jacking points and as close to the affected wheel as possible.

Front Jacking Point

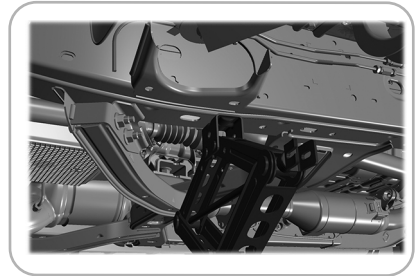
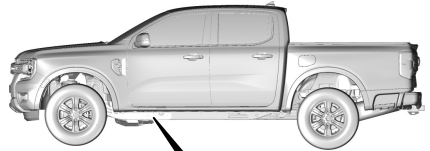

Rear Jacking Points

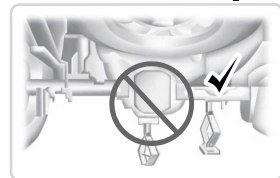

1. Place the vehicle jack at the jacking point next to the tire you are changing.

Changing a Road Wheel

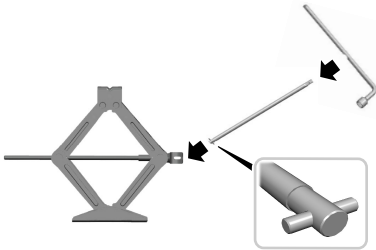

Note: When you are changing the front flat tire, connect the jack handle to the jack. Operate the jack handle with the lug nut wrench.

2. Assemble the jack handle, including the required extension tubes depending on the position you are jacking, and turn the jack handle clockwise until the wheel is completely off the ground.

Note: When changing the rear flat tire, connect all the handles together to extend the jack handle.

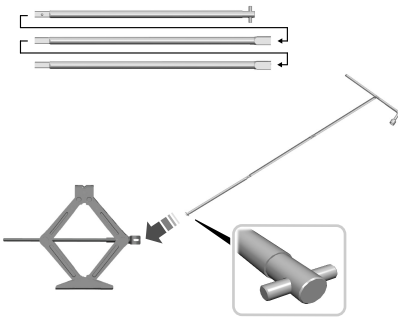

3. Raise your vehicle until the tire is clear of the ground.
4. Use the locking wheel nut key to loosen the locking wheel nut.

5. Remove the lug nuts and the road wheel.

Installing a Road Wheel



WARNING: Use only approved wheel and tire sizes. Using other sizes could damage your vehicle.



WARNING: Do not fit run flat tires on vehicles that were not originally fitted with them. See an authorized dealer for more details about compatibility.



WARNING: Make sure there is no grease or oil on the threads or the surface between the wheel studs and the wheel nuts. This can cause the wheel nuts to loosen while driving.



WARNING: Have the wheel nuts checked for tightness and the tire pressure checked as soon as possible.

Note: Make sure the wheel and hub contact surfaces are free from foreign matter.

Note: Make sure the cones on the lug nuts are against the wheel.

1. Install the wheel.
2. Install the lug nuts and finger tighten.
3. Install the locking lug nut key.

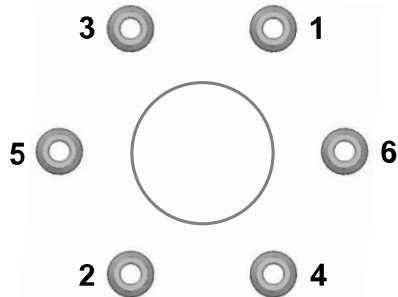

E79156

Changing a Road Wheel

- Lower your vehicle and remove the vehicle jack.
- Fully tighten all of the lug nuts in the sequence shown. See **Wheel Nuts** (page 470).

Stowing the Flat or Spare Tire

- Lay the tire on the ground, near the rear of the vehicle, with the valve stem side facing up.
- Slide the wheel partially under the vehicle and install the retainer through the wheel center. If equipped, you may have to remove the wheel center cap prior to pushing the retainer through the center of the wheel. To remove the center cap, press it off with the jack tool from the inner side of the wheel. Pull on the cable to align the components at the end of the cable.
- Insert the handle into the guide hole and engage the winch.
- Turn the swivel wrench clockwise until the tire is raised to its stowed position underneath the vehicle. The wrench becomes harder to turn and the spare tire winch ratchets or slips when the tire is raised to its maximum tightness. A clicking sound is heard from the winch indicating the tire is properly stowed.
- Carefully place all tools back to the tool kit bag.
- Reinstall the tool kit bag in the original position.
- Reinstall the jack properly on the bracket and secure the wing nut.
- Unblock the wheel.

Note: Do not use power tools on the spare wheel winch input drive.

Note: Only use the spare tire carrier to stow the tire and wheel combination provided with your vehicle. Other tire and wheel combinations can cause the tire carrier to fail.

CHANGING A FLAT TIRE - RAPTOR

If you get a flat tire when driving, do not apply the brake heavily. Instead, gradually decrease your speed, hold the steering wheel firmly and slowly move to a safe place on the side of the road.

Have the flat serviced by an authorized dealer to prevent damage to the system sensors. See **Tire Pressure Monitoring System Precautions** (page 453). Replace the spare tire with a road tire as soon as possible. During repairing or replacing the flat tire, have the authorized dealer inspect the system sensor for damage.

Note: The use of tire sealant could damage your tire pressure monitoring system and should only be used in roadside emergencies.

Note: The tire pressure monitoring system indicator light illuminates when the spare tire is in use. To restore the full function of the monitoring system, all road wheels equipped with tire pressure monitoring sensors must be mounted on this vehicle.

Dissimilar Spare Wheel and Tire Assembly Information



WARNING: Failure to follow these guidelines could result in an increased risk of loss of vehicle control, injury or death.



WARNING: If you are not sure what type of spare wheel your vehicle has, do not exceed 50 mph (80 km/h).

Changing a Road Wheel

If the spare wheel is different from the other fitted road wheels, it may have a warning label with the appropriate maximum speed limit. Drive cautiously when using a dissimilar spare wheel and tire assembly.

Full-size Dissimilar Spare Wheel With a Label on the Wheel

The label on the wheel states: Appropriate maximum speed limits.

A dissimilar spare wheel and tire is for temporary use only. Drive the shortest distance possible and have the damaged road wheel and tire repaired or replaced as soon as possible. If the dissimilar spare wheel or tire is damaged, it must be replaced.

If you use a dissimilar spare wheel and tire assembly, this can lead to impairment of the following:

- Handling, stability and braking performance.
- Comfort and noise.
- Ground clearance and parking at curbs.
- Winter weather driving capability.
- Wet weather driving capability.
- All wheel driving capability.

When driving with this type of a dissimilar spare wheel:

- Do not exceed the maximum speed as shown on the label.
- Do not load your vehicle beyond maximum vehicle load rating listed on the safety compliance label.
- Do not tow a trailer.
- Do not use snow chains on the end of your vehicle with the dissimilar spare.
- Do not use more than one dissimilar spare tire at a time.
- Do not use a commercial car wash.

Full-size Dissimilar Spare Wheel Without a Label on the Wheel

You can replace the existing road wheel with the spare and continue to drive in the normal manner.

Tire Change Procedure



WARNING: To help prevent your vehicle from moving when changing a wheel, shift the transmission into park (P), set the parking brake and use an appropriate block or wheel chock to secure the wheel diagonally opposite to the wheel being changed. For example, when changing the front left wheel, place an appropriate block or wheel chock on the right rear wheel.



WARNING: The jack supplied with this vehicle is only intended for changing a flat tire in an emergency. Do not attempt to do any other work on your vehicle when it is supported by the jack, as your vehicle could slip off the jack. Failure to follow this instruction could result in personal injury or death.



WARNING: Do not attempt to change a tire on the side of the vehicle close to moving traffic. Pull far enough off the road to not obstruct the flow of traffic and avoid the danger of being hit when operating the jack or changing the wheel.



WARNING: Only use the jack provided as original equipment with your vehicle.



WARNING: Do not get under a vehicle that is supported by a jack.



WARNING: No person should place any portion of their body under a vehicle that is supported by a jack.

Changing a Road Wheel

WARNING: Ensure screwthread is adequately lubricated before use.

WARNING: The jack should be used on level firm ground wherever possible.

WARNING: Never place anything between the vehicle jack and the ground.

WARNING: Never place anything between the vehicle jack and your vehicle.

WARNING: It is recommended that the wheels of the vehicle be chocked, and that no person should remain in a vehicle that is being jacked.

WARNING: Make sure that your vehicle is on firm and level ground with the front wheels pointing straight ahead and set up a warning triangle if available.

WARNING: If you are not sure what type of spare wheel your vehicle has, do not exceed 50 mph (80 km/h).

1. Park the vehicle on a level, firm surface and activate the hazard flashers.
2. Apply parking brake, turn the engine off and set up a warning triangle.

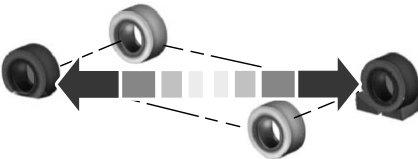

3. Block the wheel diagonally opposite the flat tire. For example, if the left front tire is flat, block the right rear wheel.

Note: *Passengers should not remain in the vehicle when the vehicle is being jacked.*

Removing the Vehicle Jack and Tool Bag

The jack, wheel brace and jack handle are located in the cab.

Note: *Not all cab configurations are available in all markets.*

Double Cab

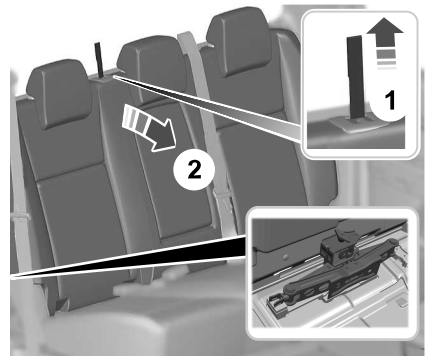

1. Lift the release strap.
2. Lower the seat back.
3. Remove the bolt.
4. Lift the jack from the foam block and remove the jack from your vehicle.

Changing a Road Wheel

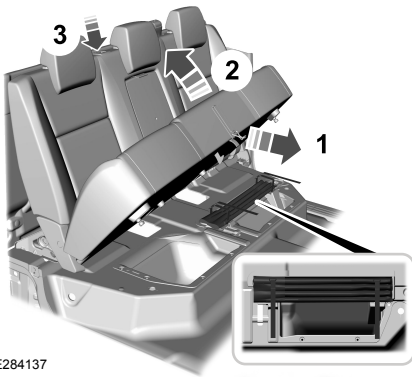

E284137

1. Pull the release strap out.
2. Lift the seat bottom up.
3. Use the tether strap to secure the seat cushion.
4. Locate tool bag and remove the securing straps.

Removing the Spare Tire

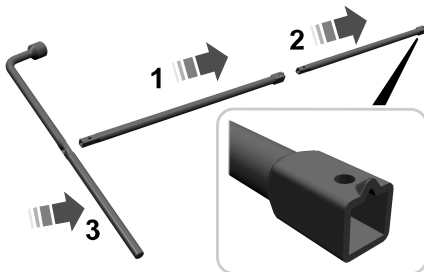

1. Assemble the handle.

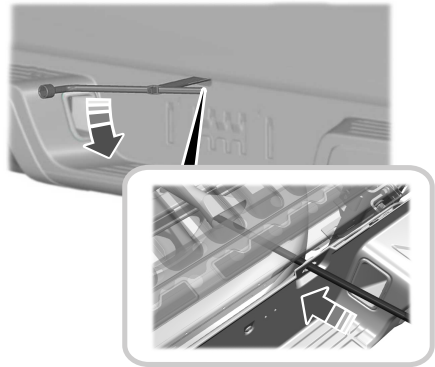

2. Insert the jack handle into the guide hole. Turn counterclockwise until the wheel rests on the ground, and there is slack in the cable.

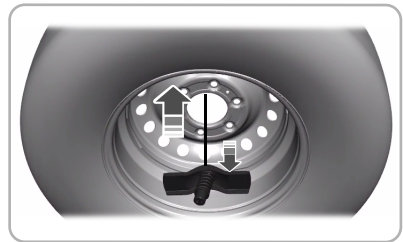
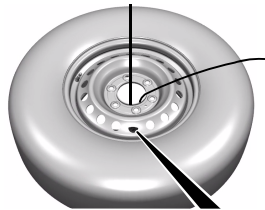

3. Pass the bracket and cable through the wheel opening.

Changing a Road Wheel



Removing a Road Wheel

⚠️ WARNING: Only use the specified jacking points. If you use any other locations you could damage vehicle components, such as brake lines.

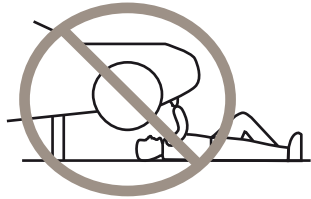

4. Vehicles with aluminum wheels, loosen each wheel lug nut one-half turn counterclockwise, but do not remove them until the wheel is raised off the ground.

Note: If the spare wheel is not the same type and size as your vehicle road wheel, drive the shortest distance possible.

Note: Do not fit more than one spare wheel on your vehicle at any one time.

Note: Using a dissimilar spare wheel or tire at any one wheel location can compromise the handling, stability and braking performance, comfort and noise.

Note: When driving with a spare tire, do not switch on four-wheel drive mode unless you need to get your vehicle unstuck.

Note: The spare wheel is located underneath the rear of the vehicle.

Note: Do not use power tools on the spare wheel winch input drive.

Note: No maintenance or additional lubrication of your jack is required over the service life of your vehicle.

Note: Jack at the specified locations to avoid damage to the vehicle.

Note: Only use the jack on the specified jacking points and as close to the affected wheel as possible.

Changing a Road Wheel

Front Jacking Points

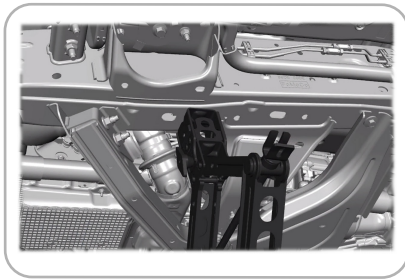
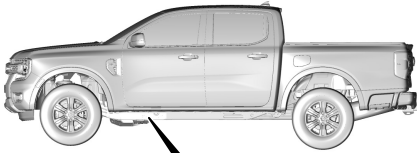

When you are jacking a flat front tire, connect the extension block to the jack loadrest using the wing bolt as shown. Connect the jack handle to the jack, and use the lug nut wrench to operate the jack.

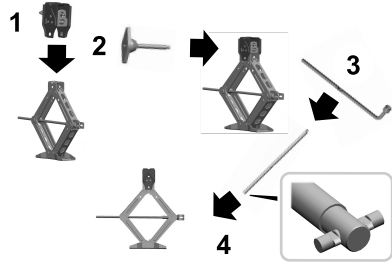

Note: Do not use the extension block when you are changing a flat tire on the rear of the vehicle. Assemble the jack handle using the extensions as shown to operate the jack when placing under the rear axle.

Rear Jacking Points

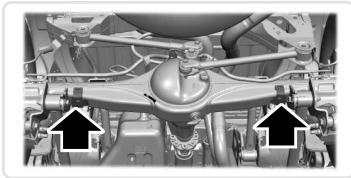

1. Place the vehicle jack at the jacking point next to the tire you are changing.
2. Assemble the jack handle, including the required extension tubes depending on the position you are jacking, and turn the jack handle clockwise until the wheel is completely off the ground.

Note: When changing the rear flat tire, connect all the handles together to extend the jack handle.

Changing a Road Wheel

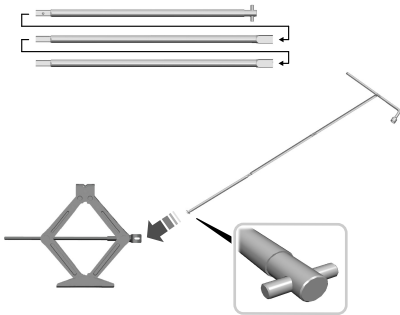

3. Raise your vehicle until the tire is clear of the ground.
4. Use the locking wheel nut key to loosen the locking wheel nut.
5. Remove the lug nuts and the road wheel.

Installing a Road Wheel

-  **WARNING:** Use only approved wheel and tire sizes. Using other sizes could damage your vehicle.
-  **WARNING:** Do not fit run flat tires on vehicles that were not originally fitted with them. See an authorized dealer for more details about compatibility.
-  **WARNING:** Make sure there is no grease or oil on the threads or the surface between the wheel studs and the wheel nuts. This can cause the wheel nuts to loosen while driving.
-  **WARNING:** Have the wheel nuts checked for tightness and the tire pressure checked as soon as possible.

Note: Make sure the wheel and hub contact surfaces are free from foreign matter.

Note: Make sure the cones on the lug nuts are against the wheel.

1. Install the wheel.
2. Install the lug nuts and finger tighten.
3. Install the locking lug nut key.

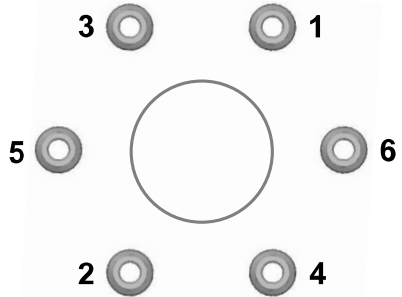

E79156

4. Lower your vehicle and remove the vehicle jack.
5. Fully tighten all of the lug nuts in the sequence shown. See **Wheel Nuts** (page 470).

Stowing the Flat or Spare Tire

1. Lay the tire on the ground, near the rear of the vehicle, with the valve stem side facing up.
2. Slide the wheel partially under the vehicle and install the retainer through the wheel center. If equipped, you may have to remove the wheel center cap prior to pushing the retainer through the center of the wheel. To remove the center cap, press it off with the jack tool from the inner side of the wheel. Pull on the cable to align the components at the end of the cable.
3. Insert the handle into the guide hole and engage the winch.

Changing a Road Wheel

- Turn the swivel wrench clockwise until the tire is raised to its stowed position underneath the vehicle. The wrench becomes harder to turn and the spare tire winch ratchets or slips when the tire is raised to its maximum tightness. A clicking sound is heard from the winch indicating the tire is properly stowed.
- Carefully place all tools back to the tool kit bag.
- Reinstall the tool kit bag in the original position.
- Reinstall the jack properly on the bracket and secure the wing nut.
- Unblock the wheel.

Note: Do not use power tools on the spare wheel winch input drive.

Note: Only use the spare tire carrier to stow the tire and wheel combination provided with your vehicle. Other tire and wheel combinations can cause the tire carrier to fail.

WHEEL NUTS



WARNING: When you install a wheel, remove any corrosion, dirt or foreign materials present on the mounting surfaces of the wheel or the surface of the wheel hub, brake drum or brake disc that contacts the wheel. Make sure to secure any fasteners that attach the rotor to the hub so they do not interfere with the mounting surfaces of the wheel. Installing wheels without following these steps can cause the wheel nuts to loosen and the wheel to come off while your vehicle is in motion, resulting in loss of vehicle control, personal injury or death.

Bolt Size	lb.ft (Nm) ¹
M12 x 1.5	100 lb.ft (135 Nm)

¹ Torque specifications are for nut and bolt threads free of dirt and rust. Use only our recommended replacement wheel nuts and or wheel bolts.

Retighten the wheel nuts to the specified torque within 100 mi (160 km) after any wheel disturbance, such as tire rotation, changing a flat tire or wheel removal.



A Hub pilot bore.

Inspect the wheel pilot hole and mounting surface prior to installation. Remove any visible corrosion or loose particles.

Locking Wheel Nuts

The locking wheel nut key is located in the glove box or next to the vehicle jack.

You can obtain replacement locking wheel nuts or a locking wheel nut key using the reference number certificate.

Capacities and Specifications

ENGINE SPECIFICATIONS - 2.3L ECOBOOST™

Engine	Specification
Compression ratio.	10.0:1
Displacement.	138 in ³ (2,261 cm ³)
Firing order.	1-3-4-2
Ignition system.	Coil on plug
Spark plug gap.	0.028 in (0.7 mm) - 0.031 in (0.8 mm)

Capacities and Specifications

ENGINE SPECIFICATIONS - 2.7L ECOBOOST™

Engine	Specification
Compression ratio.	10.0:1
Displacement.	165 in ³ (2,700 cm ³)
Firing order.	1-4-2-5-3-6
Ignition system.	Coil on plug
Spark plug gap.	0.028 in (0.7 mm) - 0.031 in (0.8 mm)

Capacities and Specifications

ENGINE SPECIFICATIONS - 3.0L ECOBOOST™

Engine	Specification
Compression ratio.	10.5:1
Displacement.	180.4 in ³ (2,956 cm ³)
Firing order.	1-4-2-5-3-6
Ignition system.	Coil on plug
Spark plug gap.	0.028 in (0.7 mm) - 0.031 in (0.8 mm)

Capacities and Specifications

MOTORCRAFT PARTS - 2.3L ECOBOOST™

Component	Motorcraft Part Number
Air filter element.	FA-2022
Battery.	BAGM-48H6-760 (less accessory switches) BAGM-94RH7-800 (with accessory switches)
Cabin air filter.	FP-93
Engine oil filter. ¹	FL-910-S
Spark plug.	SP-594
Transmission fluid filter.	FT-202 (conventional gearshift) FT-231 (electric gearshift)
Windshield wiper blade-front.	WW-2503 (driver side) WW-1708 (passenger side)

¹ If a Motorcraft oil filter is not available, use an oil filter that aligns to SAE/USCAR – 36 Performance Specifications. Filter Type B.

We recommend Motorcraft parts that are available at your authorized dealer or at www.parts.ford.com. We engineer these parts for your vehicle to meet or exceed our specifications. Use of other parts could impact vehicle performance, emissions and durability. Your warranty could be void for any damage related to use of other parts.

Capacities and Specifications

MOTORCRAFT PARTS - 2.7L ECOBOOST™

Component	Motorcraft Part Number
Air filter element.	FA-2022
Battery.	BAGM-94RH7-800
Cabin air filter.	FP-93
Engine oil filter.	FL-2062-A
Spark plug.	SP-594
Transmission fluid filter.	FT-202
Windshield wiper blades.	WW-2503 (driver side) WW-1708 (passenger side)

We recommend Motorcraft parts that are available at your authorized dealer or at www.parts.ford.com. We engineer these parts for your vehicle to meet or exceed our specifications. Use of other parts could impact vehicle performance, emissions and durability. Your warranty could be void for any damage related to use of other parts.

Capacities and Specifications

MOTORCRAFT PARTS - 3.0L ECOBOOST™

Component	Motorcraft Part Number
Air filter element.	FA-2058
Battery.	BAGM-94RH7-800
Cabin air filter.	FP-93
Engine oil filter.	FL-2062-A
Spark plug.	SP-594
Transmission fluid filter.	FT-202
Windshield wiper blades.	WW-2503 (driver side) WW-1708 (passenger side)

We recommend Motorcraft parts that are available at your authorized dealer or at www.parts.ford.com. We engineer these parts for your vehicle to meet or exceed our specifications. Use of other parts could impact vehicle performance, emissions and durability. Your warranty could be void for any damage related to use of other parts.

Capacities and Specifications

ENGINE OIL CAPACITY AND SPECIFICATION - 2.3L ECOBOOST™

Use oil that meets the defined specification and viscosity grade.

If you do not use oil that meets the defined specification and viscosity grade, it could result in:

- Component damage that your vehicle warranty does not cover.
- Longer engine cranking periods.
- Increased emission levels.
- Reduced vehicle performance.
- Reduced fuel economy.



An oil that displays this symbol conforms to current engine, emission system and fuel economy performance standards of ILSAC.

We recommend Motorcraft motor oil for your vehicle. If Motorcraft oil is not available, use motor oils of the recommended viscosity grade that display the API Certification Mark for gasoline engines.

Do not use supplemental engine oil additives because they are unnecessary and could lead to engine damage that your vehicle warranty does not cover.

Capacities

Variant	Including the Oil Filter
All.	6.0 qt (5.7 L)

Materials

Name	Specification
Motorcraft® SAE 5W-30 Motor Oil (U.S.) Motorcraft® SAE 5W-30 Motor Oil / Huile moteur SAE 5W-30 Motorcraft® (Canada) XO-5W30-Q1SP, XO-5W30-Q1FS (U.S.) CXO-5W30-LSP6, CXO-5W30-LFS6 (Canada)	WSS-M2C961-A1

Capacities and Specifications

Alternative Engine Oil for Extremely Cold Climates

To improve engine cold start performance,

we recommend that you use the following alternative engine oil in extremely cold climates, where the ambient temperature reaches -22.0°F (-30°C) or below.

Materials

Name	Specification
Engine Oil - SAE 0W-30	WSS-M2C963-A1

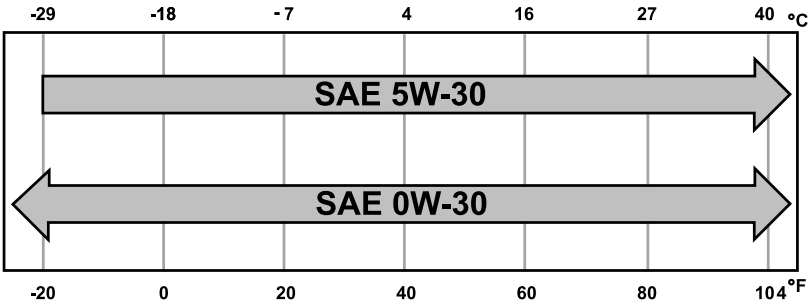

Note: If you use your vehicle regularly above the altitude of 5,000 ft (1,524 m) and under the temperature of -4.0°F (-20°C), it is recommended to use the alternative engine oil.

- Increased emission levels.
- Reduced vehicle performance.
- Reduced fuel economy.

ENGINE OIL CAPACITY AND SPECIFICATION - 2.7L ECOBOOST™

Use oil that meets the defined specification and viscosity grade.

If you do not use oil that meets the defined specification and viscosity grade, it could result in:

- Component damage that your vehicle warranty does not cover.
- Longer engine cranking periods.



Capacities and Specifications

An oil that displays this symbol conforms to current engine, emission system and fuel economy performance standards of ILSAC.

We recommend Motorcraft motor oil for your vehicle. If Motorcraft oil is not available, use motor oils of the recommended viscosity grade that display the API Certification Mark for gasoline engines.

Do not use supplemental engine oil additives because they are unnecessary and could lead to engine damage that your vehicle warranty does not cover.

Capacities

Variant	Including the Oil Filter
All.	6.0 qt (5.7 L)

Materials

Name	Specification
Motorcraft® SAE 5W-30 Motor Oil (U.S.) Motorcraft® SAE 5W-30 Motor Oil / Huile moteur SAE 5W-30 Motorcraft® (Canada) XO-5W30-Q1SP, XO-5W30-Q1FS (U.S.) CXO-5W30-LSP6, CXO-5W30-LFS6 (Canada)	WSS-M2C961-A1

Alternative Engine Oil for Extremely Cold Climates

To improve engine cold start performance, we recommend that you use the following alternative engine oil in extremely cold climates, where the ambient temperature reaches -22.0°F (-30°C) or below.

Materials

Name	Specification
Engine Oil - SAE 0W-30	WSS-M2C963-A1

Capacities and Specifications

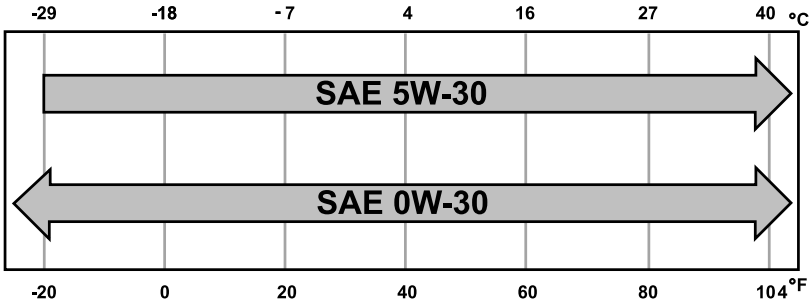

Note: If you use your vehicle regularly above the altitude of 5,000 ft (1,524 m) and under the temperature of -4.0°F (-20°C), it is recommended to use the alternative engine oil.

ENGINE OIL CAPACITY AND SPECIFICATION - 3.0L ECOBOOST™

Use oil that meets the defined specification and viscosity grade.

If you do not use oil that meets the defined specification and viscosity grade, it could result in:

- Component damage that your vehicle warranty does not cover.
- Longer engine cranking periods.
- Increased emission levels.
- Reduced vehicle performance.
- Reduced fuel economy.



An oil that displays this symbol conforms to current engine, emission system and fuel economy performance standards of ILSAC.

We recommend Motorcraft® motor oil for your vehicle. If Motorcraft® oil is not available, use motor oils of the recommended viscosity grade that display the API Certification Mark for gasoline engines.

Do not use supplemental engine oil additives because they are unnecessary and could lead to engine damage that your vehicle warranty does not cover.

Capacities and Specifications

Capacities

Variant	Including the Oil Filter
All.	7.0 qt (6.62 L)

Materials

Name	Specification
Motorcraft® SAE 5W-30 Motor Oil (U.S.) Motorcraft® SAE 5W-30 Motor Oil / Huile moteur SAE 5W-30 Motorcraft® (Canada) XO-5W30-Q1SP, XO-5W30-Q1FS (U.S.) CXO-5W30-LSP6, CXO-5W30-LFS6 (Canada)	WSS-M2C961-A1

Alternative Engine Oil for Extremely Cold Climates

To improve engine cold start performance, use the following engine oil in climates where the ambient temperature is -22.0°F (-30°C) or below.

Materials

Name	Specification
Engine Oil - SAE 0W-30	WSS-M2C963-A1

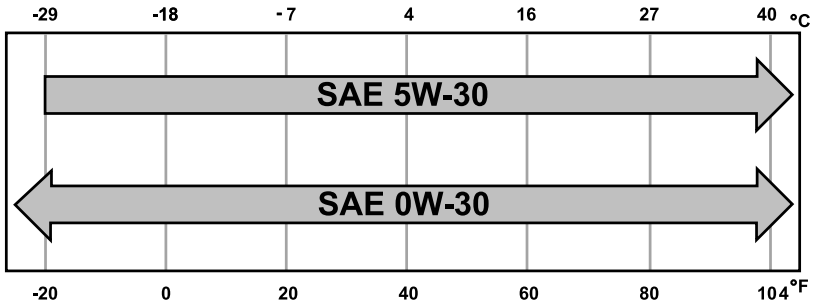

Capacities and Specifications

Note: If you use your vehicle regularly above the altitude of 5,000 ft (1,524 m) and under the temperature of -4.0°F (-20°C), it is recommended to use the alternative engine oil.

COOLING SYSTEM CAPACITY AND SPECIFICATION - 2.3L ECOBOOST™

Use coolant that meets the defined specification.

If you do not use coolant that meets the defined specification, it could result in:

- Component damage that your vehicle warranty does not cover.
- Reduced vehicle performance.

Capacities

Variant	Quantity
All.	10.5 qt (9.9 L)

Materials

Name	Specification
Motorcraft® Yellow Prediluted Antifreeze/Coolant(U.S.) Motorcraft® Yellow Prediluted Antifreeze/Coolant / Antigel/liquide de refroidissement prédilué jaune Motorcraft®(Canada) VC-13DL-G(U.S.) CVC-13DL-G(Canada)	WSS-M97B57-A2

COOLING SYSTEM CAPACITY AND SPECIFICATION - 2.7L ECOBOOST™

Use coolant that meets the defined specification.

If you do not use coolant that meets the defined specification, it could result in:

- Component damage that your vehicle warranty does not cover.
- Reduced vehicle performance.

Capacities

Variant	Quantity
All.	12.4 qt (11.7 L)

Capacities and Specifications

Materials

Name	Specification
Motorcraft® Yellow Prediluted Antifreeze/ Coolant (U.S.) Motorcraft® Yellow Prediluted Antifreeze/Coolant / Antigel/liquide de refroidissement prédilué jaune Motorcraft® (Canada) VC-13DL-G (U.S.) CVC-13DL-G (Canada)	WSS-M97B57-A2

COOLING SYSTEM CAPACITY AND SPECIFICATION - 3.0L ECOBOOST™

If you do not use coolant that meets the defined specification, it could reduce vehicle performance or cause component damage that your vehicle warranty does not cover.

Use coolant that meets the defined specification.

Capacities

Variant	Quantity
All.	12.4 qt (11.7 L)

Materials

Name	Specification
Motorcraft® Yellow Prediluted Antifreeze/ Coolant (U.S.) Motorcraft® Yellow Prediluted Antifreeze/Coolant / Antigel/liquide de refroidissement prédilué jaune Motorcraft® (Canada) VC-13DL-G (U.S.) CVC-13DL-G (Canada)	WSS-M97B57-A2

WSS-M97B57-A2 is yellow coolant. Yellow coolant may appear fluorescent green in some cooling systems which is a normal characteristic.

Note: Do not mix different colors or types of coolant in your vehicle. This reduces the effectiveness of the coolants and could void the warranty.

Capacities and Specifications

FUEL TANK CAPACITY

Capacities

Variant	Quantity
2.3L and 2.7L.	18.76 gal (71 L)
3.0L.	20.34 gal (77 L)

Capacities and Specifications

AIR CONDITIONING SYSTEM CAPACITY AND SPECIFICATION - 2.3L ECOBOOST™



WARNING: The air conditioning refrigerant system contains refrigerant under high pressure. Only qualified personnel should service the air conditioning refrigerant system. Opening

the air conditioning refrigerant system can cause personal injury.

Use refrigerant and oil that meets the defined specifications.

If you do not use refrigerant and oil that meets the defined specifications, it could result in:

- Component damage that your vehicle warranty does not cover.
- Reduced vehicle performance.

Capacities

Variant	Refrigerant	Refrigerant Oil
All.	21.2 oz (0.6 kg)	2.71 fl oz (80 ml)

Materials

Name	Specification
R-1234yf Refrigerant(U.S.) R-1234yf Refrigerant / Frigorigène R-1234yf(Canada) YN-33-A(U.S.) HS7Z-19B519-BA(Canada)	WSS-M17B21-A
Motorcraft® R-1234yf Refrigerant PAG Oil(U.S.) Motorcraft® R-1234yf Refrigerant PAG Oil / Huile PAG pour frigorigène R-1234yf Motorcraft®(Canada) YN-35(U.S. & Canada)	WSS-M2C300-A2

Capacities and Specifications

AIR CONDITIONING SYSTEM CAPACITY AND SPECIFICATION - 2.7L ECOBOOST™

the air conditioning refrigerant system can cause personal injury.

Use refrigerant and oil that meets the defined specifications.

If you do not use refrigerant and oil that meets the defined specifications, it could result in:

- Component damage that your vehicle warranty does not cover.
- Reduced vehicle performance.



WARNING: The air conditioning refrigerant system contains refrigerant under high pressure. Only qualified personnel should service the air conditioning refrigerant system. Opening

Capacities

Variant	Refrigerant	Refrigerant Oil
All.	20 oz (0.58 kg)	2.71 fl oz (80 ml)

Materials

Name	Specification
R-1234yf Refrigerant(U.S.) R-1234yf Refrigerant / Frigorigène R-1234yf(Canada) YN-33-A(U.S.) HS7Z-19B519-BA(Canada)	WSS-M17B21-A
Motorcraft® R-1234yf Refrigerant PAG Oil(U.S.) Motorcraft® R-1234yf Refrigerant PAG Oil / Huile PAG pour frigorigène R-1234yf Motorcraft®(Canada) YN-35(U.S. & Canada)	WSS-M2C300-A2

Capacities and Specifications

AIR CONDITIONING SYSTEM CAPACITY AND SPECIFICATION - 3.0L ECOBOOST™

the air conditioning refrigerant system can cause personal injury.

Use refrigerant and oil that meets the defined specifications.

If you do not use refrigerant and oil that meets the defined specifications, it could result in:

- Component damage that your vehicle warranty does not cover.
- Reduced vehicle performance.



WARNING: The air conditioning refrigerant system contains refrigerant under high pressure. Only qualified personnel should service the air conditioning refrigerant system. Opening

Capacities

Variant	Refrigerant	Refrigerant Oil
All.	20.5 oz (0.58 kg)	2.71 fl oz (80 ml)

Materials

Name	Specification
R-1234yf Refrigerant(U.S.) R-1234yf Refrigerant / Frigorigène R-1234yf(Canada) YN-33-A(U.S.) HS7Z-19B519-BA(Canada)	WSS-M17B21-A
Motorcraft® R-1234yf Refrigerant PAG Oil(U.S.) Motorcraft® R-1234yf Refrigerant PAG Oil / Huile PAG pour frigorigène R-1234yf Motorcraft®(Canada) YN-35(U.S. & Canada)	WSS-M2C300-A2

WASHER FLUID SPECIFICATION

Capacities

Variant	Quantity
All.	Fill as required.

Capacities and Specifications

Materials

Name	Specification
Motorcraft® Premium Windshield Wash Concentrate with Bitterant(U.S.) Motorcraft® Premium Quality Windshield Washer Fluid / Liquide lave-glace de haute qualité Motorcraft®(Canada) ZC-32-B2(U.S.) CXC-37-F/M(Canada)	WSS-M14P19-A

AUTOMATIC TRANSMISSION FLUID CAPACITY AND SPECIFICATION

Materials

Name	Specification
Motorcraft® MERCON® ULV Automatic Transmission Fluid(U.S.) Motorcraft® MERCON® ULV Automatic Transmission Fluid / MERCON® ULV huile pour boîtes automatique Motorcraft®(Canada) XT-12-QULV(U.S. & Canada)	WSS-M2C949-A,

Note: Only use transmission fluid that conforms to the defined specification. Use of other fluids could result in vehicle damage not covered by the vehicle warranty.

BRAKE FLUID SPECIFICATION

Use fluid that meets the defined specification and viscosity grade.

If you do not use fluid that meets the defined specification and viscosity grade, it could result in:

- Component damage that your vehicle warranty does not cover.
- Reduced brake performance.

Note: We recommend you use Dot 4 Low Viscosity (LV) High Performance Brake Fluid meeting WSS-M6C65-A2 specifications or ISO 4925 Class 6 standards. If you use any fluid other than the recommended fluid, it could cause reduced brake performance and not meet our performance standards. Keep brake fluid clean and dry. Contamination with dirt, water, petroleum products or other materials could result in brake system damage and possible failure.

Capacities and Specifications

Capacities

Variant	Quantity
All.	Fill as required.

Materials

Name	Specification
Motorcraft® DOT 4 LV High Performance Motor Vehicle Brake Fluid(U.S.) Motorcraft® DOT 4 LV High Performance Motor Vehicle Brake Fluid / Liquide de frein automobile haute performance DOT 4 LV Motorcraft®(Canada) PM-20(U.S. & Canada)	WSS-M6C65-A2

TRANSFER CASE FLUID CAPACITY AND SPECIFICATION

Use fluid that meets the defined specification and viscosity grade.

If you do not use fluid that meets the defined specification and viscosity grade, it could result in:

- Component damage that your vehicle warranty does not cover.
- Reduced vehicle performance.

Capacities

Variant	Quantity
Four-wheel drive (Electronic shift on the Fly).	1.3 qt (1.2 L)
Automatic four-wheel drive.	1.6 qt (1.55 L)

Materials

Name	Specification
Motorcraft® MERCON® LV Automatic Transmission Fluid(U.S.) Motorcraft® MERCON® LV Automatic Transmission Fluid / Huile pour boîte automatique MERCON® LV Motorcraft®(Canada) XT-10-QLVC(U.S.) CXT-10-LV6(Canada)	WSS-M2C938-A

Capacities and Specifications

FRONT AXLE FLUID CAPACITY AND SPECIFICATION

Use fluid that meets the defined specification and viscosity grade.

If you do not use fluid that meets the defined specification and viscosity grade, it could result in:

- Component damage that your vehicle warranty does not cover.
- Reduced vehicle performance.

Capacities

Variant	Quantity
Without electronic locking differential and without front axle disconnect.	23.8 ± 0.8 fl oz (705 ± 25 ml)

Materials

Name	Specification
Motorcraft® SAE 80W-90 Premium Rear Axle Lubricant(U.S.) Motorcraft® SAE 80W-90 Premium Axle Lubricant / Lubrifiant pour essieux de très haute qualité SAE 80W-90 Motorcraft®(Canada) XY-80W90-QL(U.S.) CXY-80W90-1L(Canada)	WSP-M2C197-A

REAR AXLE FLUID CAPACITY AND SPECIFICATION

Use fluid that meets the defined specification and viscosity grade.

If you do not use fluid that meets the defined specification and viscosity grade, it could result in:

- Component damage that your vehicle warranty does not cover.
- Reduced vehicle performance.

Capacities

Variant	Specification	Quantity
Standard axle high ride.	75w85	65 ± 0 fl oz (1.93 ± 0.03 L)
Locking axle high ride.	75w85	60 ± 0 fl oz (1.73 ± 0.03 L)
Raptor locking axle.	75w85	80 ± 0 fl oz (2.35 ± 0.03 L)

Capacities and Specifications

Materials

Name	Specification
Motorcraft® SAE 75W-85 Premium Synthetic Hypoid Gear Lubricant (U.S.) Motorcraft® SAE 75W-85 Premium Synthetic Hypoid Gear Lubricant / Huile synthétique de haute qualité pour engrenages hypoides SAE 75W-85 Motorcraft® (Canada) XY-75W85-QL (U.S. & Canada)	WSS-M2C942-A

Vehicle Identification

VEHICLE IDENTIFICATION NUMBER

LOCATING THE VEHICLE IDENTIFICATION NUMBER

The vehicle identification number is on the left-hand side of the instrument panel.

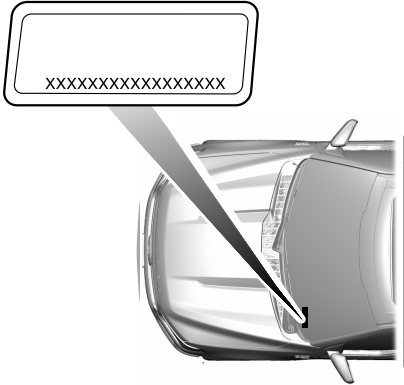

Note: In the illustration, XXXX is representative of your vehicle identification number.

VEHICLE IDENTIFICATION NUMBER OVERVIEW

The vehicle identification number contains the following information:

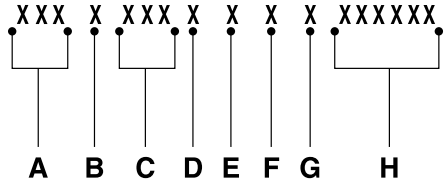

- A World manufacturer identifier.
- B Brake system, gross vehicle weight rating, restraint devices and their locations.
- C Make, vehicle line, series, body type.
- D Engine or motor type.
- E Check digit.
- F Model year.
- G Assembly plant.
- H Production sequence number.

Connected Vehicle

WHAT IS A CONNECTED VEHICLE

A connected vehicle has technology that allows your vehicle to connect to a mobile network and for you to access a range of features. When used in conjunction with the FordPass app, it could allow you to monitor and control your vehicle further, for example checking the tire pressures, the fuel level and the vehicle location. For additional information, refer to the local Ford website.

CONNECTED VEHICLE REQUIREMENTS

Connected service and related feature functionality requires a compatible vehicle network.

Some remote features require additional service activation. Log in to your Ford account for details. Some restrictions, third party terms and message or data rates may apply.

CONNECTED VEHICLE LIMITATIONS

Evolving technology, cellular networks, or regulations could affect functionality and availability, or continued provision of some features. These changes could even stop some features from functioning.

CONNECTING THE VEHICLE TO A MOBILE NETWORK

WHAT IS THE MODEM



The modem allows access to a range of features built into your vehicle.

ENABLING AND DISABLING THE MODEM

-  Press the button on the touchscreen.
- Press **Connectivity**.
- Press **Connected Vehicle Features**.
- Switch vehicle connectivity on or off.

CONNECTING FORDPASS TO THE MODEM

- Make sure that the modem is enabled using the vehicle settings menu.
- Open the FordPass app on your device and log in.
- Add your vehicle or select your vehicle if already added.
- Select the option to activate your vehicle.
- Make sure that the name on the screen matches the name shown in your FordPass account.
- Confirm that FordPass account is connected to the modem.

CONNECTING THE VEHICLE TO A WI-FI NETWORK

-  Press the button on the touchscreen.
- Press **Connectivity**.
- Press **Wi-Fi**.
- Switch **Wi-Fi** on.
- Press **View Available Networks**.
- Select an available Wi-Fi network.

Note: Enter the network password to connect to a secure network.

Connected Vehicle

CONNECTED VEHICLE – TROUBLESHOOTING

CONNECTED VEHICLE – FREQUENTLY ASKED QUESTIONS

Why can I not confirm the connection of my FordPass account to the modem?

- The modem is not enabled. Switch vehicle connectivity on.
- The network signal is weak. Move your vehicle closer to a place where the network signal is not obstructed.

Why can I not connect to a Wi-Fi network?

- You entered the wrong network password. Enter the correct password.
- The network signal is weak. Move your vehicle closer to the Wi-Fi router or to a place where the network signal is not obstructed.
- There are multiple access points in range with the same network name. Choose a unique name for your network. Do not use the default name unless it contains a unique identifier, for example as part of the MAC address.

Why does the Wi-Fi connection disconnect after successful connection?

- The network signal is weak. Move your vehicle closer to the Wi-Fi router or to a place where the network signal is not obstructed.

What can I do if I am close to a Wi-Fi router but the network signal strength is weak?

- If your vehicle has a heated windshield, position your vehicle so that the windshield is not facing the Wi-Fi router.
- If your vehicle has metallic tinting on the windows but not on the windshield, position your vehicle so that the windshield is facing the Wi-Fi router or open the windows that are facing the router.
- If your vehicle has metallic tinting on the windows and the windshield, open the windows that are facing the router.
- If your vehicle is in a garage and you have the garage door closed, open the garage door as it could block the signal.

Why can I not see a network I expect to see in the list of available networks?

- The network is hidden. Make the network visible and try again, or manually add a network in the Wi-Fi settings menu.
- Some network security types are not supported, for example WEP.

Why do software downloads take too long?

- The network signal is weak. Move your vehicle closer to the Wi-Fi router or to a place where the network signal is not obstructed.
- Wi-Fi network is in high demand or has a slow Internet connection. Use a more reliable Wi-Fi network.

Connected Vehicle

Why does the software not update when the system seems to connect to a Wi-Fi network and the signal strength is excellent?

- No software update is available at this time.
- Select automatic updates option in the settings menu to enable automatic software update or contact an authorized dealer.
- There could be a connection problem. Test the network using another device.

Vehicle Wi-Fi Hotspot

CREATING A VEHICLE WI-FI HOTSPOT

You can create a Wi-Fi hotspot in your vehicle and allow devices to connect to it for access to the Internet.

1.  Press the button on the touchscreen.

2. Press **Connectivity**.
3. Press **Vehicle Hotspot**.

Note: The vehicle hotspot default setting is on.

4. Press Settings under the Vehicle Hotspot menu.
5. Press **Edit**.
6. Switch the Wi-Fi Visibility option on or off.

Note: The Wi-Fi visibility default setting is on.

Finding the Wi-Fi Hotspot Name and Password

1.  Press the button on the touchscreen.

2. Press **Connectivity**.
3. Press **Vehicle Hotspot**.
4. Press Settings under the Vehicle Hotspot menu.

Note: The network name is the hotspot name.

5. Switch the Show Password option on or off.

Connecting a Device to the Wi-Fi Hotspot

1. On your device, switch Wi-Fi on and select the hotspot from the list of available Wi-Fi networks.
2. When prompted, enter the password.

Purchasing a Data Plan

1. Connect a device to the hotspot.

Note: The vehicle network carrier's portal opens on your device.

2. If the portal does not open on your device, open a website and it redirects to the vehicle network carrier's portal.

Note: Secure websites do not redirect.

3. Follow the instructions on the carrier portal to purchase a plan.

Note: If you have an active plan, the system does not redirect to the vehicle network carrier's portal when you connect a device. Visit the vehicle network carrier's website to purchase more data.

Note: If data usage information is available in the vehicle hotspot menu, it is approximate.

Note: If you carry out a factory reset, the system does not remove your vehicle from your vehicle network carrier's account. To remove your vehicle from the account, contact your vehicle network carrier.

Note: The vehicle network carrier provides Vehicle Hotspot services, subject to your vehicle network carrier agreement, coverage and availability.

Vehicle Wi-Fi Hotspot

CHANGING THE VEHICLE WI-FI HOTSPOT NAME OR PASSWORD

-  Press the button on the touchscreen.
- Press **Connectivity**.
- Press **Vehicle Hotspot**.
- Press Settings under the Vehicle Hotspot menu.
- Press **Edit**.
- Press **Change Network Name**.
- Enter your required network name.
- Press enter to save the network name.
- Press **Change Password**.
- Enter your required password.
- Press enter to save the password.

Changing the Wi-Fi Hotspot Frequency

Note: *The vehicle hotspot frequency band is selectable depending upon your device capabilities. You will not be able to connect your device to the vehicle hotspot if it does not support the selected frequency band.*

-  Press the button on the touchscreen.
- Press **Connectivity**.
- Press **Vehicle Hotspot**.
- Press Settings under the Vehicle Hotspot menu.
- Press **Edit**.
- Select a frequency.

VEHICLE WI-FI HOTSPOT – TROUBLESHOOTING

VEHICLE WI-FI HOTSPOT – FREQUENTLY ASKED QUESTIONS

Why can I not see the Wi-Fi hotspot name when I search for Wi-Fi networks on my cell phone or other device?

- Make sure Wi-Fi hotspot visibility is on.
- The system does not provide a Wi-Fi hotspot at this time.
- Check what frequency the hotspot is transmitting in the vehicle hotspot settings menu. If the frequency is 5 GHz and your device cannot see the network, change the frequency to 2.4 GHz.

Audio System

AUDIO SYSTEM PRECAUTIONS

 **WARNING:** Driving while distracted can result in loss of vehicle control, crash and injury. We strongly recommend that you use extreme caution when using any device that may take your focus off the road. Your primary responsibility is the safe operation of your vehicle. We recommend against the use of any hand-held device while driving and encourage the use of voice-operated systems when possible. Make sure you are aware of all applicable local laws that may affect the use of electronic devices while driving.

Listening to loud audio for long periods of time could damage your hearing.

SWITCHING THE AUDIO UNIT ON AND OFF



Press the button on the volume control.

SELECTING THE AUDIO SOURCE

1. Press your preferred audio source.

Note: Available audio sources are listed along the top of the radio screen.

PLAYING OR PAUSING THE AUDIO SOURCE



Press to pause playback. Press again to resume playback.

Note: Not all sources can be paused.

ADJUSTING THE VOLUME

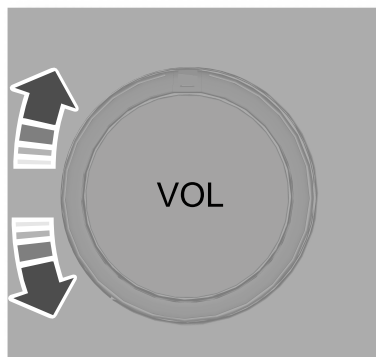

Turn to adjust the volume.

Using the Steering Wheel



Press the buttons to adjust the volume.



SWITCHING SHUFFLE MODE ON AND OFF



Press the button on the touchscreen to switch shuffle mode on or off.

Note: Not all sources have shuffle mode.

SWITCHING REPEAT MODE ON AND OFF



Press the button on the touchscreen to switch repeat mode on or off.

Note: Not all sources have repeat mode.

Audio System

SETTING A MEMORY PRESET

1. Select a station.
2. Press and hold a memory preset button on the touchscreen.

Note: The audio mutes briefly while the system saves the preset and returns once stored.

Note: You can save presets from multiple radio bands to the memory preset bar.

ADJUSTING THE SOUND SETTINGS

To access the sound settings menu:

1.  Press the button on the touchscreen.
2. Press **Sound**.

From the menu, you can adjust the following:

- Balance and fade.
- Tone settings.
- Speed compensated volume.
- Volume settings.Occupancy mode.
- Sound mode.

SETTING THE CLOCK AND DATE

1.  Press the button on the touchscreen.
2. Press **General**.
3. Press **Clock**.
4. Set the time.

Note: The **AM** and **PM** options are not available if **24-hour mode** is on.

Switching Automatic Time Updates On and Off

1.  Press the button on the touchscreen.
2. Press **General**.
3. Press **Clock**.
4. Switch **Automatic time zone update** on or off.

FM RADIO

FM RADIO LIMITATIONS

The further you travel from a FM station, the weaker the signal and the weaker the reception.

Hills, mountains, tall buildings, bridges, tunnels, freeway overpasses, parking garages, dense tree foliage and thunderstorms can interfere with the reception.

When you pass a ground-based broadcast repeating tower, a stronger signal may overtake a weaker one and result in the audio system muting.

SELECTING AN FM RADIO STATION

Manually Selecting a Radio Station

 Press the button on the radio tuner to go up the frequency band.

 Press the button on the radio tuner to go down the frequency band.

Audio System

Using Seek



Press to seek the next station up the frequency band.

Press and hold to quickly seek up the frequency band.



Press to seek the next station down the frequency band.

Press and hold to quickly seek down the frequency band.

Using the Station List

1. Press the search button on the radio screen.
2. Press a radio station from the list.

DIGITAL RADIO (IF EQUIPPED)

WHAT IS DIGITAL RADIO

HD Radio™ technology is the digital evolution of analog FM radio.

For additional information, visit www.HDRadio.com.

HD Radio Technology is manufactured under license from iBiquity Digital Corporation and foreign patents. HD Radio and the HD and HD Radio logos are proprietary trademarks of XPERI. The vehicle manufacturer and XPERI are not responsible for the content sent using HD Radio technology. Content may be changed, added or deleted at any time at the station owner's discretion.

HOW DOES DIGITAL RADIO WORK

Your system has a special receiver that allows it to receive digital broadcasts in addition to analog broadcasts.

HD1 signifies the main programming status and is available in both analog and digital broadcasts. Other multicast stations are only available digitally and could contain new or different content.

Note: *When the system first receives an HD1 station, it plays the station in the analog version until it verifies the station is an HD Radio station. Then it shifts to the digital version.*

Note: *There is an audio mute delay when switching to an HD2 or HD3 station because the system has to reacquire and decode the digital signal.*

DIGITAL RADIO LIMITATIONS

If you are outside the reception area, the system could not work.

If you are on the fringe of the reception area, the station could mute due to weak signal strength.

Note: *If you are listening to HD1, the system changes back to the analog broadcast until the digital broadcast is available again. If you are listening to any other multicast channels, the station mutes and stays muted unless it is able to connect to the digital signal again.*

Depending on the station quality, you could hear a slight sound change when the station changes between analog and digital audio.

You cannot access a saved HD station if your vehicle is outside the station's reception area.

SWITCHING DIGITAL RADIO RECEPTION ON AND OFF

1. Press **Settings** on the touchscreen.
2. Press **Radio Settings**.
3. Switch **HD Radio** on or off.

Audio System

DIGITAL RADIO INDICATORS

HD Radio Indicator

The indicator appears when HD Radio is on and you tune to a station broadcasting HD Radio technology.



The color of the indicator changes to indicate the system status.

Gray indicates the system is acquiring a digital station.

Orange indicates digital audio is playing.

Multicast Indicator

The multicast indicator appears if the current station is broadcasting multiple digital broadcasts. The highlighted numbers indicate additional digital channels available.

Note: For stations that have more than one HD multicast, the HD indicator and radio text appears as a button. Press the button to cycle through all of the HD stations on that specific frequency.

SATELLITE RADIO (IF EQUIPPED)

WHAT IS SATELLITE RADIO

Your factory-installed SiriusXM radio system includes a limited subscription term, which begins on the date of sale or lease of your vehicle. See an authorized dealer for availability.

For additional information about extended subscription terms, visit www.SiriusXM.com in the United States, www.SiriusXM.ca in Canada, or call SiriusXM at 1-888-539-7474.

Note: SiriusXM reserves the unrestricted right to change, rearrange, add or delete programming including canceling, moving or adding particular channels, and its prices, at any time, with or without notice to you. Neither SiriusXM and its affiliates nor Ford Motor Company and its affiliates will be liable to you or any third party for any such modification, suspension or termination.

SATELLITE RADIO LIMITATIONS

For optimal reception performance, keep the antenna clear of snow and ice build-up and keep luggage and other material as far away from the antenna as possible. Placing luggage over the antenna may reduce performance. Factory-installed and aftermarket vehicle structures including, but not limited to, roof racks and soft top roofs in a partially open position could reduce reception performance.

Hills, mountains, tall buildings, bridges, tunnels, freeway overpasses, parking garages, dense tree foliage and thunderstorms can interfere with your reception.

When you pass a ground-based broadcast-repeating tower, a stronger signal may overtake a weaker one and could result in the audio system muting. Your display could show an error message to indicate the interference.

LOCATING THE SATELLITE RADIO IDENTIFICATION NUMBER

1. Select SiriusXM as the audio source.
2. Tune to channel 0.

Audio System

SELECTING A CHANNEL

Manually Selecting a Channel



Press the button to find the previous or next available radio channel.



Linear Tuner

The linear tuner is displayed when manually selecting a channel. You can swipe left or right on the linear tuner carousel to navigate through the channel list. Tap on a channel title to listen to it.

Using Direct Tune

1. Press the channel up or down button to open the linear tuner screen.
2. Press **Direct Tune** to open the number pad.
3. Enter the channel you prefer.

Using Browse

1. Press **Browse**.
2. Select a channel.

SATELLITE RADIO SETTINGS

Subscription

Your subscription status is displayed. You can subscribe or manage your subscription directly from the touchscreen.

SiriusXM Favorites

While you are listening to SiriusXM, you can save favorites by:

- Tapping the currently tuned channel or show logo on the SiriusXM audio screen.
- Tuning to a channel or show you want to save as a favorite. Navigate to the SiriusXM Favorites screen and press the Add Current button. The currently tuned channel or show is saved as a favorite.
- Saving a radio preset. This saves the currently tuned SiriusXM channel or show as a favorite

Note: Requires a trial or active subscription to use.

Listening History

Listening history is a list of recently listened to SiriusXM content. You can view, manage and reset the listening history using the controls on the touchscreen.

Note: Requires a trial or active subscription to use.

Help and Support

You can contact SiriusXM Customer Care directly from the operating system and view information required to manage your SiriusXM account.

Audio System

AUDIO SYSTEM – TROUBLESHOOTING

AUDIO SYSTEM – INFORMATION MESSAGES

Satellite Radio Troubleshooting

Error Message	Potential Effects	Recommended Action
Connectivity Disabled	Internet streaming and On Demand shows are unavailable and some SiriusXM features are disabled.	Internet connectivity is turned off. See Connected Vehicle (page 493).
No Internet	Audio system may mute. Switch to Satellite button may be displayed on the SiriusXM audio screen if the channel is also available via satellite.	SYNC attempts to connect. See Satellite Radio Limitations (page 501). Switch to a satellite connection for the current channel if the option is available.
No Satellite Signal	Audio system may mute. Switch to Internet button may be displayed on the SiriusXM audio screen if the channel is also available via streaming.	Antenna may be obstructed or satellite reception is weak in your location. See Satellite Radio Limitations (page 501). Switch to an internet connection for the current channel if the option is available.
Slow Network Connection	Audio system may mute while the audio attempts to load.	Allow some time for the audio to load or tune to a different channel.
Channel Unavailable	Audio system may mute. Radio may tune to a different channel.	A temporary update may be in progress. Allow some time before retrying to tune to the channel. If the issue continues, the channel may no longer be available.
Episode Unavailable	Audio system may mute. Radio may tune to a different channel.	A temporary update may be in progress. Allow some time before retrying to play the episode. If the issue continues, the episode may no longer be available.

Audio System

Error Message	Potential Effects	Recommended Action
Something went wrong	Audio system may mute. Radio may tune to a different channel.	Allow some time and retry the action.
Subscribe to Listen	Cannot listen to selected content. Content may appear grayed out and some features may be disabled.	<p>Your subscription has expired or you have not yet subscribed for access to the listed content. Navigate to Subscription under the Satellite Radio Settings menu. If you have an active subscription which includes the listed channel or content and you see this error, you may need to refresh your radio. To refresh your SiriusXM radio, visit www.siriusxm.com/refresh in the US, or www.siriusxm.ca/refresh in Canada.</p> <p>You may need to provide your SiriusXM Radio identification number. See Locating the Satellite Radio Identification Number (page 501).</p>

Audio System

Error Message	Potential Effects	Recommended Action
Upgrade to Listen	Cannot listen to selected content. Content may appear grayed out and some features may be disabled.	<p>Your subscription does not include access to the listed content. You may need to upgrade your subscription. Navigate to Subscription under the Satellite Radio Settings menu. If you have an active subscription which includes the listed channel or content and you see this error, you may need to refresh your radio. To refresh your SiriusXM radio, visit www.siriusxm.com/refresh in the US, or www.siriusxm.ca/refresh in Canada. You may need to provide your SiriusXM Radio identification number. See Locating the Satellite Radio Identification Number (page 501).</p>
Location Restricted Content	Audio may mute. Not available in your location or Unable to determine your location may be displayed.	Content is not available in your location or SiriusXM is unable to determine your location. Tuning to a different channel may resolve the issue.
Channel Blocked	Audio may mute. Radio may tune to a different channel.	<p>The Block Explicit Content filter is turned on. Navigate to Listener Settings under the Satellite Radio Settings menu to access the Block Explicit Content filter. Navigate to Listener Settings. See Satellite Radio Settings (page 502).</p>
Antenna Problem or Hardware Problem	Audio may mute. Access to SiriusXM features may be unavailable.	If issue persists, you may need to visit an authorized dealer for service.

Audio System

Error Message	Potential Effects	Recommended Action
SiriusXM Updating...	Audio may mute.	Allow SiriusXM some time to complete updating.
Loading...	Audio may mute. Content may be temporarily unavailable while loading.	No action necessary. If loading time is longer than usual, See Satellite Radio Settings (page 502).
SiriusXM Loading...	Audio may mute. Content and controls may be temporarily unavailable.	No action necessary. Allow SiriusXM some time to finish loading.

Center Display

CENTER DISPLAY OVERVIEW



WARNING: Driving while distracted can result in loss of vehicle control, crash and injury. We strongly recommend that you use extreme caution when using any device that may take your focus off the road. Your primary responsibility is the safe operation of your vehicle. We recommend against the use of any hand-held device while driving and encourage the use of voice-operated systems when possible. Make sure you are aware of all applicable local laws that may affect the use of electronic devices while driving.

For your safety, features that are not critical while driving are not available when the vehicle is moving at or above 5 mph (8 km/h).

Note: Illustrations are provided for conceptual understanding only and may appear differently on your vehicle.

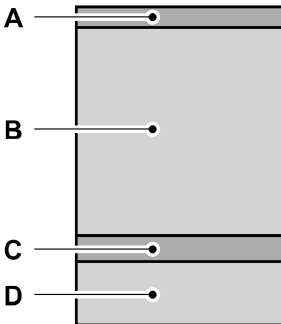

- A Status bar. See **Status Bar** (page 507).
- B Open app area.

- C App bar.
- D Climate control. See **Climate Control** (page 137).

STATUS BAR

The status bar appears at the top of the display. The following buttons and icons can appear in the status bar.

Note: Some buttons and icons may not apply to your vehicle or may not appear exactly as shown.

App Launcher



Press to see a list of apps. To open an app, select the app.

Settings



Press to open the settings menu. See **Settings** (page 508).

Apple CarPlay and Android Auto



Press to open Apple CarPlay or Android Auto. See **Switching Apple CarPlay On and Off** (page 519). See **Switching Android Auto On and Off** (page 519).



Alexa Built-In



Press to set up Alexa. See **Alexa Built-In** (page 512).

Camera



Press to access the camera screen.

Center Display

Connected Device



Automatic crash notification system off.



Device signal strength.



Device signal roaming.



Device signal not available.

Vehicle Data and Location



Vehicle data sharing on.



Vehicle data sharing off.



Vehicle location sharing on.



Vehicle data and vehicle location sharing on.

Vehicle Signal



Vehicle signal strength.



Vehicle signal roaming.



Vehicle signal not available.



Wi-Fi connected.

Traffic Announcements



Traffic announcements are turned on but are not supported by the selected station.



Traffic announcements are turned on and supported by the selected station but are not active.



Traffic announcements are active.

Note: If no traffic announcement icons are displayed, traffic announcements are turned off.

Wireless Charging



Wireless charging active.



Device connected and not charging.

Personal Profiles



Press to change or add a profile.

SETTINGS

-  Press to open the settings menu.
- Select an item on the side menu to access specific settings. The main area changes as you select different side menu items.
- Press the icon again to close the list of settings.



If you see this icon next to a menu option, press it to expand the menu and see additional settings.

Center Display



If you see this icon next to a menu option, press it for more information.

REBOOTING THE CENTER DISPLAY

You can reboot the center display using the controls on the steering wheel.

1. Simultaneously press and hold the seek forward and volume down button for 10 seconds.

Voice Interaction

WHAT IS VOICE INTERACTION

Voice Interaction allows you to control vehicle features using conversational requests.

SETTING THE WAKE WORD

-  Press the button on the touchscreen.
- Press the **Ford Assistant**.
- Press **Preferred Wake Word**.
- Select a wake word.

BEGINNING A VOICE INTERACTION

Say the selected wake word.



Press the voice interaction button on the steering wheel.

Note: If the wake word is not enabled, you can only use the voice interaction button.

VOICE INTERACTION EXAMPLES

General Examples

Command	Result
Start Over.	The system resets the current voice interaction.
Cancel.	The system ends the current voice interaction.
Next Page.	The system goes to the next page.
Previous Page.	The system goes to the previous page.
Help.	The system displays a list of available commands you can use on the current screen.

Entertainment Examples

Command	Result
Play The Beatles.	The system plays music by the selected artist.
Show music by The Beatles.	The system shows music by the selected artist.
Set the station to 101.9 FM.	The system tunes the radio to 101.9 FM.
Set the station to BBC Radio 1.	The system tunes the radio to BBC Radio 1.

Voice Interaction

Climate Examples

Command	Result
I am cold.	The system prompts you to change the temperature.
Set the temperature to 72°F (22°C).	The system sets the temperature to 72°F (22°C).

Phone Examples

Command	Result
Call Henry.	The system calls Henry using your connected device.
Dial (phone number).	The system dials the selected phone number.
Send a text message to Henry.	The system begins a dictated text message.
Read my message from Henry.	The system reads you the most recent message from Henry.

Apps Examples

Command	Result
Mobile Apps.	The system prompts you to say the name of an app to start it on the system.
List Mobile Apps.	The system will list all of the currently available Mobile Apps.
Find Mobile Apps	The system will search and connect to compatible app running on your mobile device.

Navigation Examples

Command	Result
Drive to 1 Main Street in London England.	The system begins guided navigation to the address.
Show me directions to the Eiffel Tower.	The system shows directions to the selected POI.
Show me directions to Garden Street and School Street.	The system shows directions to the selected intersection.
Cancel route.	The system ends guided navigation to the destination.

Alexa Built-In

WHAT IS ALEXA BUILT-IN

Allows you to use Alexa in your vehicle for auto-specific use cases on the road and gives you access to an ever-evolving number of skills that help to make your life more productive, entertaining, and connected while using your vehicle.

ALEXA BUILT-IN REQUIREMENTS

To use Alexa, all of the following must occur:

- Your vehicle modem is enabled.
- You are signed in to an existing Amazon account.
- Vehicle location services are enabled.
- Vehicle connectivity and vehicle data sharing is enabled.

SIGNING IN TO YOUR ACCOUNT



Press the button in the status bar and follow the on-screen prompts.

To sign in using the settings menu:

1.  Press the button on the touchscreen.
2. Press **Amazon Alexa**.
3. Press **Get Started**.
4. Sign in to the Amazon account by either scanning the QR code or entering the on-screen code into the Amazon website.
5. Once logged in, follow the on-screen prompts.

6. When complete, the vehicle informs you that Alexa is ready to be used in the vehicle.

Signing Out of Your Account

1.  Press the button on the touchscreen.
2. Press **Amazon Alexa**.
3. Press **Sign Out**.

USING ALEXA BUILT-IN

To use Alexa, say “Alexa” or press the voice interaction button on the steering wheel and then say “Alexa” to invoke Alexa to start listening.

Note: *If the wake word is not enabled, you can only use the voice interaction button.*

You can use Alexa for the following and more:

- Entertainment.
- Hands-free calling.
- Traffic and navigation.
- Vehicle controls.
- Smart home device control.
- Weather and news information.

ALEXA BUILT-IN SETTINGS

Enabling the Wake Word

1.  Press the button on the touchscreen.
2. Press **Amazon Alexa**.
3. Switch **Listen for Wake Word** on or off.

Note: *If the wake word is not enabled, you can only use the voice interaction button.*

Alexa Built-In

Contact List

Displays a list of connected phones and contact sharing status for each phone.

To change the contact sharing status:

1.  Press the button on the touchscreen.
2. Press **Amazon Alexa**.
3. Press **Contact List**.
4. Enable or disable sharing for each phone.

Note: *You can share contacts from more than one phone at a time.*

Things to Try

Learn more about what you can do with Alexa by browsing the things to try.

1.  Press the button on the touchscreen.
2. Press **Amazon Alexa**.
3. Press **Things to Try**.

Phone

PHONE PRECAUTIONS



WARNING: Driving while distracted can result in loss of vehicle control, crash and injury. We strongly recommend that you use extreme caution when using any device that may take your focus off the road. Your primary responsibility is the safe operation of your vehicle. We recommend against the use of any hand-held device while driving and encourage the use of voice-operated systems when possible. Make sure you are aware of all applicable local laws that may affect the use of electronic devices while driving.

CONNECTING YOUR PHONE

Connecting your phone stores contact and call data on your vehicle. This data is used to provide intelligent suggestions. You can switch this off in the touchscreen settings menu.

Note: *Unpairing your phone removes the contact and call data from your vehicle and stops intelligent call suggestions.*

Go to the settings menu on your device and switch **Bluetooth®** on.



Select the phone option in the feature drawer.

1. Select **Add Phone**.
2. Follow the instructions on the screen to pair your device.

PHONE MENU



Press to view your favorite contacts.



Press to view your recent calls.



Press to view your contacts



Press to use the phone keypad.



Press to display recent text messages.



Press to view recent emails.

Press the down arrow to view additional items for a connected device.



Press to begin a voice interaction.



Press to switch to a different connected device.



Press to mute notifications.



Press to access phone settings.

Phone

MAKING AND RECEIVING A PHONE CALL

Making Calls

To call a number in your contacts, select:

Menu Item	Action and Description
Contacts	You can then select the name of the contact you want to call. Any numbers stored for that contact display along with any stored contact photos. You can then select the number that you want to call. The system begins the call.

To call a number from your recent calls, select:

Menu Item	Action and Description
Recent Call List	You can then select an entry that you want to call. The system begins the call.

To call a number from your favorites, select:

Menu Item	Action and Description
Favorites	You can then select an entry that you want to call. The system begins the call.

To call a number that is not stored in your phone, select:

Menu Item	Action and Description
Phone Keypad	Select the digits of the number you wish to call.
Call	The system begins the call.

Pressing the backspace button deletes the last digit you typed.

Receiving Calls

During an incoming call, an audible tone sounds. Caller information appears in the display if it is available.

To accept the call, select:

Menu Item
Accept

Note: You can also accept the call by pressing the phone button on the steering wheel.

To reject the call, select:

Menu Item
Reject

Ignore the call by doing nothing. The system logs it as a missed call.

During a Phone Call

During a phone call, the contacts name and number display on the screen along with the call duration.

The phone status items are also visible:

- Signal Strength.
- Battery.

You can select any of the following during an active phone call:

Phone

Item	
End Call	Immediately end a phone call. You can also press the button on the steering wheel.
Keypad	Press this to access the phone keypad.

Item	
Mute	You can switch the microphone off so the caller does not hear you.
Privacy	Transfer the phone call audio to the cell phone or back to the touchscreen.

SENDING AND RECEIVING A TEXT MESSAGE

Menu Item	Description
Hear It	Hear the text message.
View	View the text message.
Call	Call the sender.
Reply	Reply to the text message with a standard text message.

SWITCHING TEXT MESSAGE NOTIFICATION ON AND OFF

The settings on your device must be enabled to receive text message notifications on the center display. Check your device settings to enable these features.

Bluetooth®

CONNECTING A BLUETOOTH® DEVICE

1. Make sure **Bluetooth®** is enabled on your device.
2. Press **Settings** on the touchscreen.
3. Press **Connectivity**.
4. Press **Bluetooth**.
5. Press **Add a Bluetooth Device**.

Note: A prompt alerts you to search for your vehicle on your device.

6. Select your vehicle on your device.

Note: A number appears on your device and on the touchscreen.

7. Confirm that the number on your device matches the number on the touchscreen.

Note: The touchscreen indicates that you have successfully paired your device.

The **Bluetooth®** word mark and logos are registered trademarks owned by **Bluetooth SIG, Inc.** and any use of such marks by Ford Motor Company is under license. Other trademarks and trade names are those of their respective owners.

PLAYING MEDIA USING BLUETOOTH®



WARNING: Driving while distracted can result in loss of vehicle control, crash and injury. We strongly recommend that you use extreme caution when using any device that may take your focus off the road. Your primary responsibility is the safe operation of your vehicle. We recommend against the use of any

hand-held device while driving and encourage the use of voice-operated systems when possible. Make sure you are aware of all applicable local laws that may affect the use of electronic devices while driving.

1. Connect your device to Bluetooth®
- 2.



Press the button on the touchscreen. See **Center Display Overview** (page 507).



Press to play a track. Press again to pause the track.



Press to skip to the next track.

Press and hold to fast forward through the track.



Press once to return to the beginning of a track. Repeatedly press to return to previous

tracks.

Press and hold to fast rewind through the track.

Browsing your Media Library

When a compatible mobile device is connected to the vehicle, your media library accessible through the touchscreen. From the touchscreen, you can browse through songs, albums, artists, and playlists on your mobile device.

Note: This feature is dependent on the connected mobile device and the media application used.

Note: Browse feature functionality may be limited while driving.

Apps

APP PRECAUTIONS



WARNING: Driving while distracted can result in loss of vehicle control, crash and injury. We strongly recommend that you use extreme caution when using any device that may take your focus off the road. Your primary responsibility is the safe operation of your vehicle. We recommend against the use of any hand-held device while driving and encourage the use of voice-operated systems when possible. Make sure you are aware of all applicable local laws that may affect the use of electronic devices while driving.

APP REQUIREMENTS

When you start an app through the system for the first time, you could be asked to grant certain permissions. You can review and change the permissions that you have granted at any time when your vehicle is not moving. We recommend that you check your data plan before using your apps through the system. Using them could result in additional charges. We also recommend that you check the app provider's terms and conditions and privacy policy before using their app. Make sure that you have an active account for apps that you want to use through the system. Some apps will work with no setup. Others require you to configure some personal settings before you can use them.

ENABLING APPS ON AN IOS DEVICE

1. Follow the instructions to pair and connect your device via **Bluetooth®** or with a USB cable.

Note: Some apps may run through CarPlay if it is enabled.

2. Start a compatible app on your device.

Note: The app must be open on your device to use it through the touchscreen.

3. Access the system applications.
4. Select the app you wish to use on the touchscreen.

ENABLING APPS ON AN ANDROID DEVICE

1. Pair your device to **Bluetooth®**.

Note: Some apps may run through Android Auto if it is enabled.

2. Start a compatible app on your device.

Note: The app must be open on your device to use it through the touchscreen.

3. Access the system applications.
4. Select the app you wish to use on the touchscreen.

SWITCHING APPLE CARPLAY ON AND OFF

1. Pair your device.

- 2.



Press the button on the touchscreen.

3. Press **Phone List**.
4. Select your device.
5. Tap the CarPlay icon to switch CarPlay on or off.

SWITCHING ANDROID AUTO ON AND OFF

1. Pair your device.

Apps

2.  Press the button on the touchscreen.
3. Press **Phone List**.
4. Select your device.
5. Tap the Android Auto icon to switch Android Auto on or off.

Navigation (If Equipped)

CONNECTED NAVIGATION (IF EQUIPPED)

Your vehicle may be equipped with connected navigation. Depending on your version, you are given a 90 day or 3 year trial. After the trial period, you need to sign up to continue the experience. For additional information, visit ford.com/connectedservices.

Note: *If you do not sign up or renew your subscription, you can still use navigation through a connected device.*

ACCESSING NAVIGATION

-  Press the button on the touchscreen to open the application drawer.
- Press **Navigation**.

Note: *As the driver, be aware of all local traffic regulations and road attributes, and operate your vehicle in a safe and legal manner.*

NAVIGATION MAP UPDATES

To update your Map data over Wi-Fi, your vehicle must be connected to a Wi-Fi access point. For USB updates and other details, contact an authorized Ford dealer.

Note: *If you find map data errors, you may report them by going to www.here.com/mapcreator.*

ADJUSTING THE MAP

ZOOMING THE MAP IN AND OUT

You can use pinch gestures to zoom in and out. Place two fingers on the screen and move them apart to zoom in. Place two fingers on the screen and bring them together to zoom out.

CHANGING THE FORMAT OF THE MAP



Press the map format button on the left side of the map screen to toggle between the available formats.

LIVE TRAFFIC

WHAT IS LIVE TRAFFIC

You can observe real-time road congestion when live traffic is on.

SWITCHING LIVE TRAFFIC ON AND OFF

- Press the tools button on the map screen.
- Press Navigation Settings.
- Press the Traffic button.
- Switch Traffic on or off.

SETTING A DESTINATION

SETTING A DESTINATION USING THE TEXT ENTRY SCREEN

- Press the search bar at the top of the screen.
- Enter your destination using the keyboard.

Navigation (If Equipped)

3. Select a destination from the list.
4. Press Go! to begin navigation.

SETTING A DESTINATION USING THE MAP SCREEN

Press on the map to trigger the roaming and viewing screen. Press on the map again to place a pin at that location. Information about the location of the pin appears on the screen. Press the Go! button to begin navigation to the pin.

SETTING A DESTINATION USING A PREDICTIVE DESTINATION

Switching Predictive Destinations On and Off

You can switch Destination Suggestions on and off under the User Data section in the navigation settings menu.

Setting a Destination

Access the feature bar using the touchscreen and select the predicted destination at the top of the screen. You can access additional predictive destinations by pressing the search bar on the map screen and then pressing the myTrends button.

SETTING A DESTINATION USING A RECENT DESTINATION

1. Press the search bar on the map screen.
2. Press Recents.
3. Select a destination from the list.

SETTING A DESTINATION USING A SAVED DESTINATION

1. Press the search bar.
2. Press favorites.

3. Select a saved destination.

Note: Press the star icon next when viewing location details to save the location.

SETTING A DESTINATION USING A POINT OF INTEREST

Press on a point of interest icon on the map. Information about the location of the point of interest appears on the screen. Press the Go! button to begin navigation to the point of interest.

WAYPOINTS

ADDING A WAYPOINT

1. Begin navigation to a destination.
2. Search for your waypoint using the search bar.
3. Press Go!
4. Press Add to add the waypoint to your trip.

EDITING WAYPOINTS

1. Press the search bar on the map screen.
2. Press myTrips.
3. Press Current Trip.
4. Use the menu to add destinations, remove destinations, or rearrange destinations.

ROUTE GUIDANCE

ADJUSTING THE GUIDANCE PROMPT VOLUME

Turn the volume control when a guidance prompt plays to adjust the volume.

Navigation (If Equipped)

REPEATING AN INSTRUCTION

Press the turn indicator to hear the last voice instruction.

CANCELING ROUTE GUIDANCE



Press the button to cancel route guidance to the selected location.

TRAILER TOWING NAVIGATION

The system calculates the best route for trailer towing by avoiding dangerous road conditions based on the dimensions of your trailer.

Switching Trailer Towing Navigation On and Off

1. Press the **Navigation** button on the feature bar.
2. Press the **Menu** button.
3. Press **Trailer Routing**.
4. Switch **Trailer-optimized Routing** on or off.

Entering Trailer Dimensions

1. Press the **Navigation** button on the feature bar.
2. Press the **Menu** button.
3. Press **Trailer Routing**.
4. Press **Towing Menu**.
5. Press **Add Trailer**.
6. Follow the instructions on the screen to enter the type and dimensions of the trailer into the system.

Navigation Alerts

Alerts will appear on the navigation map while driving. An orange alert triangle indicates you should proceed with caution. When not following active guidance to a destination, a red alert triangle may appear and indicates you should avoid the road and find a detour.

Vehicle Software Updates

This introduces new features and provides updates to the vehicle's software systems. Make sure to switch Automatic Updates on, set a recurring update schedule and connect your vehicle to Wi-Fi. Updates could take longer when not connected to Wi-Fi or could not download at all. See **Connecting the Vehicle to a Wi-Fi Network** (page 493).

Your vehicle may be able to receive drivable software updates, non-drivable software updates or both. Drivable software updates happen during normal vehicle usage and require limited input from you. You are notified on your touchscreen and connected device prior to a non-drivable update.

Most non-drivable updates complete in less than 30 minutes, although some updates could take up to a few hours.

You are notified of vehicle software update status on to the top left of touchscreen. You can also see the notifications in your connected device. See **Software Update Indicators** (page 525).

Vehicle Software Update Requirements

Non-drivable software updates do not install if any of the following occur:

- Your vehicle is running.
- Your vehicle is switched on.
- Your vehicle is not parked.
- The 12 V battery charge is too low.
- The hazard indicators are switched on.
- The alarm is sounding.
- The doors are open.
- The parking lamps are switched on.
- You are pressing the brake pedal.
- An emergency call is in process.
- Your vehicle is in limp home mode.

Vehicle Software Update Limitations

Once you begin a non-drivable software update, you cannot:

- Cancel the update.
- Enter your vehicle unless you have a key blade.
 - You can open the doors using the mechanical latch if child locks are not on.
- Use the remote control to lock, unlock or start your vehicle.
- Drive your vehicle.
- Charge your vehicle.
 - Charging resumes once the update completes.

SOFTWARE UPDATE SETTINGS

1.  Press the button on the touchscreen.
2. Press **Software Updates**.

You can do the following in the Software Updates menu:

- Switch Automatic Updates on and off.
- Schedule and install software updates.
- View software update details.

1.  Press the button next to a menu option for more information.

Vehicle Software Updates

Switching Automatic Updates On and Off

Your vehicle may come with Automatic Updates switched on. To make sure your vehicle always has the latest software, which could include security or other enhancements, we do not recommend switching Automatic Updates off.

Note: *Software updates require approval to download or install with Automatic Updates switched off.*

Scheduling and Installing Software Updates

Scheduling Software Updates

From the Software Updates menu:

1. Press **Schedule Updates**.
2. Select the days and time for updates.
3. Press **Save**.

The more days that updates are scheduled, the more frequently your vehicle installs new updates. We recommend selecting a time you normally do not need your vehicle, such as overnight.

Some updates require your vehicle to be switched off.

Note: *The schedule you set is recurring. If Automatic Updates is on, every time a non-drivable update is available, it installs on this schedule unless you change it. You are notified on your touchscreen and connected device prior to a non-drivable update, with an option to reschedule it.*

Installing Software Updates

Using the Status Bar

1. Press a Software Update indicator on your touchscreen when it appears.
2. Follow the instructions on the touchscreen.

Using the Touchscreen

From the Software Updates menu:

1. Press **Update Details**.
2. Press **Update Now**.

Viewing Software Update Details

From the Software Updates menu:

1. Press **Update Details**.

SOFTWARE UPDATE INDICATORS

You can press the indicators in the status bar when they appear for more information.



Vehicle software update reminder, schedule required, confirmation of default schedule required, or consent required.



Vehicle software update canceled, update not successful, or precondition not met.



Vehicle software update successful.

Vehicle System Reset

PERFORMING A SYSTEM RESET

Make sure you perform a system reset whenever there is a transfer of ownership of the vehicle to prevent the loss of personal data. Performing a system reset allows you to remove all personal information and restore the modem and SYNC to their factory defaults.

In the modem, this deletes all the authorized users, removes access to the connected vehicle via all linked FordPass accounts. In the SYNC system this deletes all data imported from mobile devices connected to the vehicle via Bluetooth® including the addresses manually entered into the navigation system.

Note: *If you are the first owner, your modem comes in partially activated state.*

Note: *If you are not the first owner, it comes in either fully activated, partially activated or deactivated state.*

1.  Press the button on the touchscreen.
2. Press **General**.
3. Press **Reset**.
4. Press **Factory Reset**.
5. Follow the prompts on the touchscreen to complete the reset.

Accessories

For a complete listing of the accessories that are available for your vehicle, please contact your authorized dealer or visit the online store web site:

Web Address (United States)

www.Accessories.Ford.com
--

Web Address (Canada)

www.Accessories.Ford.ca
--

We will repair or replace any properly authorized dealer-installed Ford Original Accessory found to be defective in factory-supplied materials or workmanship during the warranty period, as well as any component damaged by the defective accessories.

We will warrant your Ford Original Accessory through the warranty that provides the greatest benefit:

- 24 months, unlimited mileage.
- The remainder of your new vehicle limited warranty.

Contact an authorized dealer for details and a copy of the warranty.

Ford Licensed Accessories are the accessory manufacturer's designs. The manufacturer develops and therefore warrants Ford Licensed Accessories, and does not design or test these accessories to Ford Motor Company engineering requirements.

Contact an authorized Ford dealer for the manufacturer's limited warranty details, and request a copy of the Ford Licensed Accessories product limited warranty from the accessory manufacturer.

Most Ford Performance Parts are sold with no warranty, unless otherwise indicated. Check the Ford Performance Part website: www.performanceparts.ford.com or contact the Ford Performance Parts tech-line at (800) FORD788 for the latest limited warranty information on specific products.

For maximum vehicle performance, keep the following information in mind when adding accessories or equipment to your vehicle:

- When adding accessories, equipment, passengers and luggage to your vehicle, do not exceed the total weight capacity of the vehicle or of the front or rear axle (GVWR or GAWR as indicated on the Safety Compliance Certification label). Ask an authorized dealer for specific weight information.
- The Federal Communications Commission (FCC) and Canadian Radio Telecommunications Commission (CRTC) regulate the use of mobile communications systems that are equipped with radio transmitters, for example two-way radios, telephones and theft alarms. Any such equipment installed in your vehicle should comply with Federal Communications Commission (FCC) and Canadian Radio Telecommunications Commission (CRTC) regulations and should be installed only by an authorized dealer.

Accessories

- An authorized dealer needs to install mobile communications systems. Improper installation may harm the operation of your vehicle, particularly if the manufacturer did not design the mobile communication system specifically for automotive use.
- If you or an authorized Ford dealer add any non-Ford electrical or electronic accessories or components to your vehicle, you may adversely affect battery performance and durability. In addition, you may also adversely affect the performance of other electrical systems in the vehicle.

Auxiliary Switches

WHAT ARE THE AUXILIARY SWITCHES

The auxiliary switchboard on the overhead console makes aftermarket customization easier with six prewired switches connected to the power distribution box. Each circuit is individually fused for connection of electrical accessories.

For maximum vehicle performance, keep the following information in mind when adding accessories or equipment to your vehicle:

- When adding accessories, equipment, passengers and luggage to your vehicle, do not exceed the total weight capacity of the vehicle or of the front or rear axle (GVWR or GAWR as indicated on the safety compliance certification label). Ask an authorized dealer for specific weight information.
- It is your responsibility to ensure that any equipment you have fitted complies with applicable local legislation.
- An authorized dealer needs to install mobile communication systems. Improper installation may harm the operation of your vehicle, particularly if the manufacturer did not design the mobile communication system specifically for automotive use.
- If you or an authorized dealer add any electrical or electronic accessories or components not produced by us to your vehicle, you may adversely affect battery performance and durability. In addition, you may also adversely affect the performance of the other electrical systems in the vehicle.

LOCATING THE AUXILIARY SWITCHES

The switches are labeled AUX 1 through AUX 6.

The auxiliary switches only operate when the ignition is in the on or off position and the delay accessory is active, whether the engine is running or not

We recommend that you leave the engine running to maintain battery charge when using the switches for an extended time or when using higher current draw accessories.

When a switch is turned on, the indicator light on the switch illuminates and the circuit provides power to the device wired to that switch.



Note: *When your vehicle has a diesel engine, use the auxiliary switches only the ignition key is in the on position. Using the auxiliary switches, even for limited amounts of time, can cause your battery to drain quickly and prevent your vehicle from starting.*

LOCATING THE AUXILIARY SWITCH WIRING

There are three sets of blunt-cut sealed circuits:

Auxiliary Switches

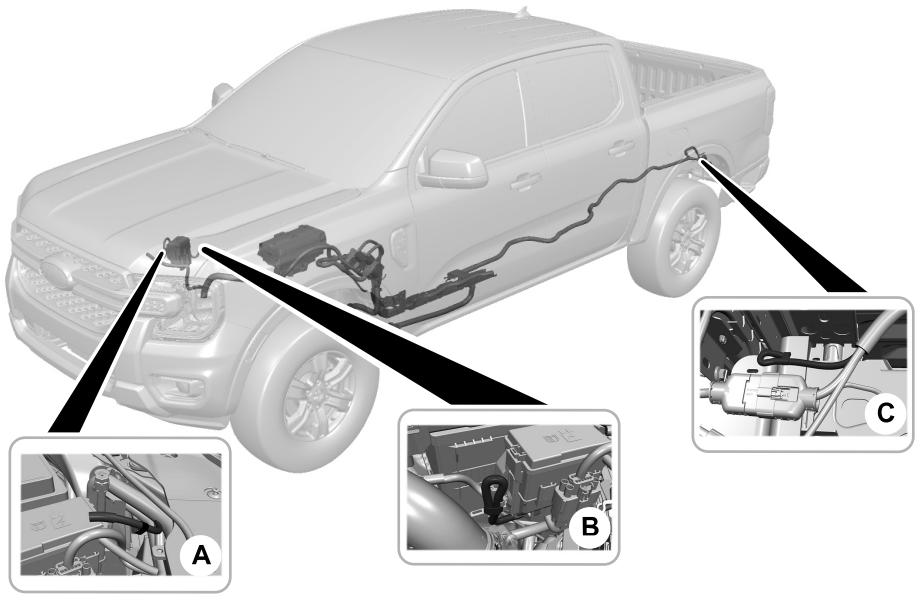

A	Circuit to radiator support.	Aux 6 Wire Location
B	Circuit near auxiliary fuse box.	Aux 1 Wire Location Aux 2 Wire Location Aux 5 Wire Location
C	Circuit to trailer hitch.	Aux 3 Wire Location Aux 4 Wire Location

Circuits from the under hood fuse box are powered. All other circuits are not connected at either end.

Additional information on fuse and relay locations is available. See your authorized dealer for service.

IDENTIFYING THE AUXILIARY SWITCH WIRING

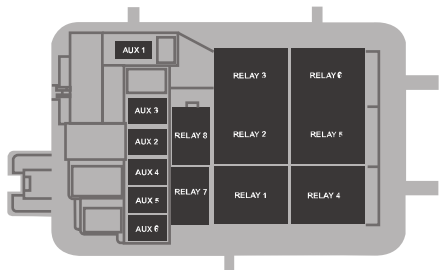

Auxiliary Switches

The relays are coded as follows:

Interior overhead console	Wire Color	Wire Size	Fuse	Protected Component	Blunt cut Wire Location
AUX 1	Violet/Green	1.5 mm ²	5A	Relay 1	Vehicle location B
AUX 2	Blue/Orange	1.5 mm ²	15A	Relay 2	Vehicle location B
AUX 3	Yellow/Orange	1.5 mm ²	15A	Relay 3	Vehicle location C
AUX 4	Brown	1.5 mm ²	15A	Relay 4	Vehicle location C
AUX 5	Green/Brown	2.5 mm ²	25A	Relay 5 (Driving lamps)	Vehicle location B
AUX 6	Yellow	2.5 mm ²	25A	Relay 6 (Driving lamps)	Vehicle location A
Protected Component			Purpose		
Relay 7			Not used		
Relay 8			Auxiliary switch power		

Ground information:

Power Distribution Box	Wire Color	Wire Size	Location
AUX 3	Black/Grey	1.5 mm ²	Vehicle location C
AUX 4	Black/Green	1.5 mm ²	Vehicle location C
AUX 6	Black/Yellow	2.5 mm ²	Vehicle location A

Ford Protect

WHAT IS FORD PROTECT

Protect yourself from the rising cost of vehicle repairs with a Ford Protect extended service plan.

Ford Protect Extended Service Plans - United States Only

Ford Protect extended service plans mean peace of mind. Extended service plans are backed by Ford Motor Company, and provide more protection beyond the New Vehicle Limited Warranty coverage. When you visit your Ford Dealer, insist on the Ford Protect extended service plan.

Ford Protect Can Quickly Pay for Itself

One trip to the service center could easily exceed the price of your Ford Protect extended service plan. With the Ford Protect extended service plan, you minimize your risk for unexpected repair bills and rising repair costs.

Up to 1,000+ Covered Vehicle Components

There are four mechanical Ford Protect extended service plans with different levels of coverage. Ask your authorized dealer for details.

1. PremiumCARE - Our most comprehensive coverage. With over 1,000 covered components, this plan is so complete it is probably easier to list what is not covered.
2. ExtraCARE - Covers 113 components, and includes many high-tech items.
3. BaseCARE - Covers 84 components.
4. PowertrainCARE - Covers 29 critical components.

Ford Protect extended service plans are honored by all authorized Ford dealers in the United States, Canada and Mexico.

That means you get:

- Reliable, quality service at any Ford or Lincoln dealership.
- Repairs performed by factory trained technicians, using genuine parts.

Rental Car Reimbursement

First Day Rental Benefit

If you bring your car into your dealer for service, we will give you a rental vehicle to use for the day.

Extended Rental Benefits

If your vehicle is kept overnight for covered repairs, you are eligible for rental car coverage, warranty repairs, and field service actions.

Roadside Assistance

Exclusive 24/7 roadside assistance, including:

- Towing, flat-tire change and battery jump starts.
- Out of fuel and lock-out assistance.
- Travel expense reimbursement for lodging, meals and rental car.
- Assistance for taxi, shuttle, rental car coverage or other transportation.

Transferable Coverage

If you sell your vehicle before your Ford Protect extended service plan coverage expires, you can transfer any remaining coverage to the new owner. This should give you and your potential buyer peace of mind.

Ford Protect

Less Cost to Properly Maintain Your Vehicle

The Ford Protect extended service plan also offers a Premium Maintenance Plan that covers all scheduled maintenance, and selected wear items. The coverage is prepaid, so you never have to worry about the cost of your vehicle's maintenance.

Covered maintenance includes:

- Windshield wiper blades.
- Spark plugs.
- The clutch disc (if equipped).
- Brake pads and linings.
- Shock absorbers.
- Struts.
- Engine belts.
- Engine coolant hoses, clamps and o-rings.
- Diesel exhaust fluid replenishment (if equipped).
- Cabin air filter replacement every 20,000 mi (32,000 km) for electric vehicles only.

Interest Free Finance Options

Just a 5% down payment provides you with an affordable, no interest, no fee payment program allowing you all the security and benefits Ford Protect extended service plan has to offer while paying over time. You are pre-approved with no credit check or hassles. To learn more, call our Ford Protect extended service plan specialists at 800-367-3377.

Ford Protect Extended Service Plan
P.O. Box 321067
Detroit, MI 48232

Ford Protect Extended Service Plan (Canada Only)

You can get more protection for your vehicle by purchasing a Ford Protect extended service plan. Ford Protect extended service plan is the only service contract backed by Ford Motor Company of Canada, Limited. Depending on the plan you purchase, Ford Protect extended service plan provides benefits such as:

- Rental reimbursement.
- Coverage for certain maintenance and wear items.
- Protection against repair costs after your New Vehicle Limited Warranty Coverage expires.
- Roadside Assistance benefits.

There are several Ford Protect extended service plans available in various time, distance and deductible combinations. Each plan is tailored to fit your own driving needs, including reimbursement for towing and rental. When you purchase Ford Protect extended service plan, you receive added peace-of-mind protection throughout Canada, the United States and Mexico, provided by a network of participating authorized Ford Motor Company dealers.

Note: *Repairs performed outside of Canada and the United States are not eligible for Ford Protect extended service plan coverage.*

This information is subject to change. Visit your local Ford of Canada dealer or www.ford.ca to find the Ford Protect extended service plan that is right for you.

Scheduled Maintenance

GENERAL MAINTENANCE INFORMATION

Why Maintain Your Vehicle?

Carefully following the maintenance schedule helps protect against major repair expenses resulting from neglect or inadequate maintenance and may help to increase the value of your vehicle when you sell or trade it. Keep all receipts for completed maintenance with your vehicle.

It is important that you have your vehicle serviced at the proper times. These intervals serve two purposes: first is to maintain the reliability of your vehicle and the second is to keep the cost of owning your vehicle down.

It is your responsibility to have all scheduled maintenance performed and to make sure that the materials used meet the specifications identified in this owner's manual. See **Capacities and Specifications** (page 471).

Failure to perform scheduled maintenance and regularly inspect your vehicle may result in vehicle damage not covered by the vehicle Warranty.

Why Maintain Your Vehicle at Your Dealership?

Our Genuine Replacement Parts

Dealerships stock our parts and our authorized branded remanufactured replacement parts. These parts meet or exceed our specifications. Parts installed at your dealership carry a nationwide 24-month or unlimited mile (kilometer) parts and labor limited warranty.

If you do not use our authorized parts, they may not meet our specifications and could affect emissions compliance.

Protecting Your Investment

Maintenance is an investment that pays dividends in the form of improved reliability, durability and resale value. To maintain the proper performance of your vehicle and its emission control systems, make sure you have scheduled maintenance performed at the designated intervals.

Your vehicle comes with the Intelligent Oil-Life Monitor system, a message appears in the instrument cluster display at the proper oil change interval. This interval may be up to one year or 10,000 mi (16,000 km), hybrid vehicles could exceed 10,000 mi (16,000 km).

When the oil change message appears in the instrument cluster display, it is time for an oil change. Make sure you perform the oil change within two weeks or 500 mi (800 km) of the message appearing. Make sure to reset the Intelligent Oil-Life Monitor after each oil change. See **Resetting the Intelligent Oil Life Monitor** (page 407).

If your instrument cluster display resets prematurely or becomes inoperative, you should perform the oil change interval at six months or 5,000 mi (8,000 km) from your last oil change. Never exceed one year or 10,000 mi (16,000 km) between oil change intervals.

You can drive your vehicle in such a way that may lead to higher oil consumption including extended time at high engine speeds, high loads, engine braking, hard cornering maneuvers, track and off-road usage. Under these conditions, oil consumption of approximately 1 quart per 500 miles (1 liter per 800 km) is possible. Check the engine oil level at every refueling and adjust to maintain proper levels to avoid engine damage.

Scheduled Maintenance

You can also drive your vehicle in such a way that dilutes and increases the level of oil by frequent short trips that do not allow the engine to get to operating temperature, extended idling and low speed driving for long periods of time.

It is important to rely upon your dealership to properly diagnose and repair your vehicle.

We strongly recommend only using our genuine or our authorized re-manufactured replacement parts engineered for your vehicle.

Additives and Chemicals

We do not recommend using chemicals or additives not approved by us as part of your vehicle's normal maintenance. Please consult your warranty information.

Oils, Fluids and Flushing

In many cases, fluid discoloration is a normal operating characteristic and, by itself, does not necessarily indicate a concern or that the fluid needs to be changed. Have discolored fluids that also show signs of overheating or foreign material contamination checked immediately.

Make sure to change the vehicle's oils and fluids at the specified intervals or in conjunction with a repair. Flushing is a viable way to change fluid for many vehicle sub-systems during scheduled maintenance. It is critical that systems are flushed only with new fluid that is the same as that required to fill and operate the system or using our approved flushing chemical.

Scheduled Maintenance Service Intervals

For your scheduled maintenance service intervals, visit <https://www.ford.com/support/maintenance-schedule>.

Owner Checks and Services

Make sure you perform the following basic maintenance checks and inspections.

Check Every Month
The engine oil level.
Function of all interior and the exterior lights.
The tires including the spare for wear and proper pressure.
The windshield washer fluid level.

Scheduled Maintenance

Check Every Six Months
The battery connections. Clean if necessary.
The body and door drain holes for obstructions. Clean if necessary.
The cooling system fluid level and the coolant system strength.
The door weatherstrips for wear. Lubricate if necessary.
The hinges, latches and outside locks for proper operation. Lubricate if necessary.
The parking brake for proper operation.
The seatbelts and seat latches for wear and function.
Safety warning lamps, brake, ABS, airbag and seatbelt for operation.
The washer spray and wiper operation. Clean or replace blades as necessary.

Multi-Point Inspection

It is important to have the systems on your vehicle regularly checked. This can help identify potential issues and prevent major problems. We recommend having the following multi-point inspection performed at every scheduled maintenance interval to help make sure your vehicle keeps running great.

Multi-Point Inspection	
Accessory drive belt or belts	Hazard warning system operation
Battery performance	Horn operation
Engine air filter	Radiator, cooler, heater and air conditioning hoses
Exhaust system	Suspension components for leaks or damage
Exterior lamps operation	Steering and linkage
Fluid levels ¹ ; fill if necessary	Tires including the spare for wear and proper pressure ²

Scheduled Maintenance

Multi-Point Inspection	
For oil and fluid leaks	Windshield for cracks, chips or pits
Halfshaft dust boots	Washer spray and wiper operation

¹ Brake, coolant recovery reservoir, automatic transmission and window washer.

² If your vehicle has a temporary mobility kit, check the tire sealant expiration Use By date on the canister. Replace as needed.

Be sure to ask your dealership service advisor or technician about the multi-point vehicle inspection. It is a comprehensive way to perform a thorough inspection of your vehicle. Your checklist gives you immediate feedback on the overall condition of your vehicle.

Customer Information

ROLLOVER WARNING



WARNING: Utility vehicles have a significantly higher rollover rate than other types of vehicles.



WARNING: Vehicles with a higher center of gravity (utility and four-wheel drive vehicles) handle differently than vehicles with a lower center of gravity (passenger cars). Avoid sharp turns, excessive speed and abrupt steering in these vehicles. Failure to drive cautiously increases the risk of losing control of your vehicle, vehicle rollover, personal injury and death.



WARNING: In a rollover crash, an unbelted person is significantly more likely to die than a person wearing a seatbelt.



WARNING: Do not become overconfident in the ability of four-wheel drive vehicles. Although a four-wheel drive vehicle may accelerate better than a two-wheel drive vehicle in low traction situations, it won't stop any faster than two-wheel drive vehicles. Always drive at a safe speed.

Utility vehicles and trucks handle differently than passenger cars in the various driving conditions that are encountered on streets, highways and off-road. Utility vehicles and trucks are not designed for cornering at speeds as high as passenger cars any more than low-slung sports cars are designed to perform satisfactorily under off-road conditions.

THE BETTER BUSINESS BUREAU AUTO LINE PROGRAM

Your satisfaction is important to Ford Motor Company and to your dealer. If a warranty concern has not been resolved using the three-step procedure outlined earlier in this chapter in the Getting the Services you need section, you may be eligible to participate in the BBB AUTO LINE program.

The BBB AUTO LINE program consists of two parts – mediation and arbitration. During mediation, a representative of the BBB will contact both you and Ford Motor Company to explore options for settlement of the claim. If an agreement is not reached during mediation or you do not want to participate in mediation, and if your claim is eligible, you may participate in the arbitration process. An arbitration hearing will be scheduled so that you can present your case in an informal setting before an impartial person. The arbitrator considers the testimony provided and makes a decision after the hearing.

Disputes submitted to the BBB AUTO LINE program are usually decided within 40 days after you file your claim with the BBB. You are not bound by the decision, and may reject the decision and proceed to court where all findings of the BBB Auto Line dispute, and decision, are admissible in the court action. Should you choose to accept the BBB AUTO LINE decision, Ford is then bound by the decision, and must comply with the decision within 30 days of receipt of your acceptance letter.

BBB AUTO LINE Application: Using the information that follows, call or write to request a program application. You will be asked for your name and address, general information about your new vehicle, information about your warranty concerns, and any steps you have already taken to

Customer Information

try to resolve them. A Customer Claim Form will be mailed that needs to be completed, signed and returned to the BBB along with proof of ownership. Upon receipt, the BBB reviews the claim for eligibility under the Program Summary Guidelines.

You can get more information by calling BBB AUTO LINE at 1-800-955-5100, or writing to:

**BBB AUTO LINE a Division of BBB National Programs, Inc.
1676 International Drive, Suite 550
McLean, VA 22102**

BBB AUTO LINE applications can also be requested by calling the Ford Motor Company Customer Relationship Center at 1-800-392-3673.

For additional information, refer to the Better Business Bureau website.

Note: *Ford Motor Company reserves the right to change eligibility limitations, modify procedures, or to discontinue this process at any time without notice and without obligation.*

THE MEDIATION AND ARBITRATION PROGRAM

For vehicles delivered to authorized Canadian dealers. In those cases where you continue to feel that the efforts by Ford of Canada and the authorized dealer to resolve a factory-related vehicle service concern have been unsatisfactory, Ford of Canada participates in an impartial third party mediation/arbitration program administered by the Canadian Motor Vehicle Arbitration Plan (CAMVAP).

The CAMVAP program is a straightforward and relatively speedy alternative to resolve a disagreement when all other efforts to produce a settlement have failed. This procedure is without cost to you and is designed to eliminate the need for lengthy and expensive legal proceedings.

In the CAMVAP program, impartial third-party arbitrators conduct hearings at mutually convenient times and places in an informal environment. These impartial arbitrators review the positions of the parties, make decisions and, when appropriate, render awards to resolve disputes. CAMVAP decisions are fast, fair, and final as the arbitrator's award is binding on both you and Ford of Canada.

CAMVAP services are available in all Canadian territories and provinces. For more information, without charge or obligation, call your CAMVAP Provincial Administrator directly at 1-800-207-0685 or visit www.camvap.ca.

ORDERING A CANADIAN FRENCH OWNER'S MANUAL

You can obtain a French owner's manual from an authorized dealer or by contacting Helm, LLC at:

HELM, LLC
47911 Halyard Drive, Suite 200
Plymouth, Michigan 48170
Attention: Customer Service

Call toll free: 1-800-782-4356

Monday-Friday 8:00 a.m. - 6:00 p.m. EST

For additional information, visit www.helminc.com.

Customer Information

REPORTING SAFETY DEFECTS IN THE UNITED STATES

If you believe that your vehicle has a defect which could cause a crash or could cause injury or death, you should immediately inform the National Highway Traffic Safety Administration (NHTSA) in addition to notifying Ford Motor Company.

If NHTSA receives similar complaints, it may open an investigation, and if it finds that a safety defect exists in a group of vehicles, it may order a recall and remedy campaign. However, NHTSA cannot become involved in individual problems between you, your dealer, or Ford Motor Company.

To contact NHTSA, you may call the Vehicle Safety Hotline toll-free at 1-888-327-4236 (TTY: 1-800-424-9153); go to www.safercar.gov; or write to:

Administrator

1200 New Jersey Avenue,
Southeast

Washington, D.C. 20590

You can also obtain other information about motor vehicle safety from www.safercar.gov.

REPORTING SAFETY DEFECTS IN CANADA

If you believe that your vehicle has a defect which could cause a crash or could cause injury or death, you should immediately inform Transport Canada and Ford of Canada.

Transport Canada Contact Information

Website (English)	http://tc.canada.ca/recalls
Website (French)	http://tc.canada.ca/rappels
Phone	1-800-333-0510

Ford of Canada Contact Information

Website	www.ford.ca
Phone	1-800-565-3673

Customer Information

THIRD PARTY SOFTWARE COPYRIGHT ACKNOWLEDGMENT

Your vehicle could have components that use open source software. For additional information, visit <http://corporate.ford.com/ford-open-source.html>.

Ghana

NCA APPROVED: 7E5-7M-XC6-RDR

RADIO FREQUENCY CERTIFICATION LABELS

AUDIO UNIT

Armenia

NCA APPROVED: 7E5-7M-XC7-RDR



Serbia

European Union EU

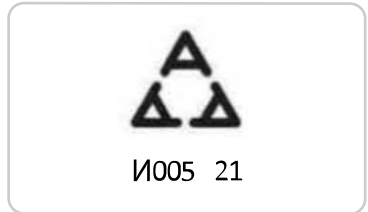
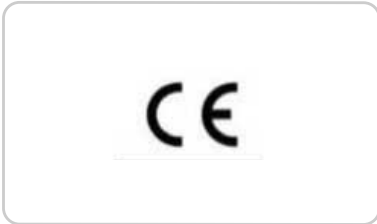

Customer Information

South Africa



South Korea



R-R-VC1-AHUA001

R-R-VC1-AHUB001

United Kingdom



United States

This device complies with part 15 of the FCC Rules. Operation is subject to the condition that this device does not cause harmful interference.

BLIND SPOT INFORMATION SYSTEM SENSORS

Device	Supplier	Type Designation
SRR5 BLIS Corner Radar (RRU2)	Aptiv	2F5TR

Customer Information

Argentina



H-28070

Europe Union EU

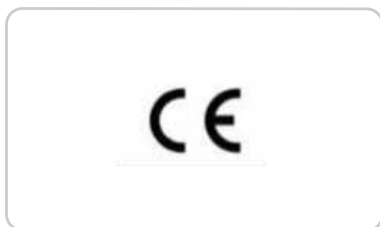

Ghana

NCA APPROVED: 7E6-M0-XDF-TME

Jamaica

This product has been Type Approved by Jamaica: SMA - 2F5TR.

Paraguay



NR: 2022-04-I-0255

United Arab Emirates (U.A.E.)

TRA REGISTERED No:

ER10085/22

DEALER No:

DA37380/15

Customer Information

United Kingdom



United States and Canada



WARNING: Changes or modifications not expressly approved by the party responsible for compliance could void the user's authority to operate the equipment. The term "IC:" before the radio certification number only signifies that Industry Canada technical specifications were met.

FCC ID: L2C2F5TR

IC: 3432A-2F5TR

This device complies with Part 15 of the FCC Rules and with Innovation, Science and Economic Development Canada's licence-exempt RSS(s). Operation is subject to the following two conditions:

1. This device may not cause harmful interference, and
2. This device must accept any interference received, including interference that may cause undesired operation.

BLIND SPOT INFORMATION SYSTEM SENSORS

Argentina

CNC COMISIÓN NACIONAL DE COMUNICACIONES

CNC ID: H-24708

Brazil



Agência Nacional de Telecomunicações

17075-21-12270

Djibouti

AGREE PAR LE MCPT (REPUBLIQUE DE DJIBOUTI)
Numéro d'agrément: 195/MCPT/DDTIC
Date d'agrément: 06/09/2021

Customer Information

Europe Union EU

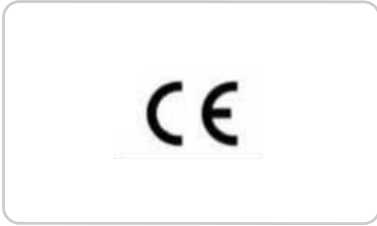

Mauritania

AGREE PAR L'ANE MAURITANIE
Numéro d'agrément : 0985/ARE/2021
Date d'agrément : 24/08/2021

Ghana

NCA APPROVED: SRO-1M-7E4-X0E

Mexico

IFETEL: RCPAPF520-0480

Morocco

AGREE PAR L'ANRT MAROC
Numéro d'agrément : MR00030033ANRT2021
Date d'agrément : 16/09/2021

Jamaica

This product has been Type Approved by Jamaica: SMA – FSTR.

Customer Information

Paraguay



2020-10-I-0753

Singapore

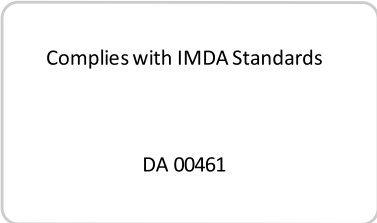

South Africa



South Korea



Taiwan



Thailand

- (1) เครื่องใช้โทรคมนาคมและอุปกรณ์นี้ มีความสอดคล้องตามข้อกำหนดของ กทท.
- (2) เครื่องใช้โทรคมนาคมและอุปกรณ์การนี้ สอดคล้องกับข้อกำหนดทางเทคนิคของมาตรฐานความถี่ของสํานักงานการสื่อสารแห่งชาติของประเทศไทย

Customer Information

Ukraine



United Arab Emirates (U.A.E.)



United Kingdom



United States and Canada

WARNING: Changes or modifications not expressly approved by the party responsible for compliance could void the user's authority to operate the equipment. The term "IC:" before the radio certification number only signifies that Industry Canada technical specifications were met.

FCC ID: L2CF5TR

IC: 3432A-F5TR

This device complies with Part 15 of the FCC Rules and with Innovation, Science and Economic Development Canada's licence-exempt RSS(s). Operation is subject to the following two conditions:

1. This device may not cause harmful interference, and
2. This device must accept any interference received, including interference that may cause undesired operation.

Vietnam

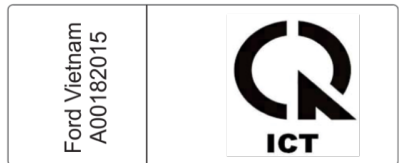

Customer Information

BODY CONTROL MODULE

Jamaica

Argentina



This product has been Type Approved by Jamaica: SMA - M3NA2C766336.

Brazil



Moldova



Morocco

Ghana

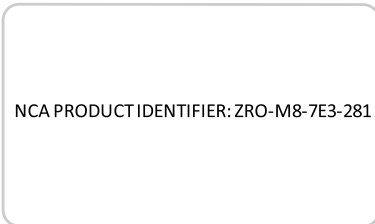

Customer Information

Paraguay



2019-01-I-000076

Serbia



Singapore

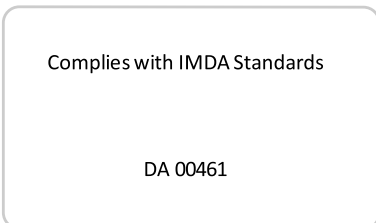

South Africa



Ukraine



United Arab Emirates (U.A.E.)

TRA REGISTERED No: ER68566/19

DEALER No: DA37380/15

United Kingdom



Customer Information

United States and Canada



WARNING: Changes or modifications not expressly approved by the party responsible for compliance could void the user's authority to operate the equipment. The term "IC:" before the radio certification number only signifies that Industry Canada technical specifications were met.

FCC ID: M3NA2C766336

IC: 7812A-A2C766336

This device complies with Part 15 of the FCC Rules and with Innovation, Science and Economic Development Canada's licence-exempt RSS(s). Operation is subject to the following two conditions:

1. This device may not cause harmful interference, and
2. This device must accept any interference received, including interference that may cause undesired operation.

Vietnam

Ford Vietnam
A00182015



Zambia



CRUISE CONTROL MODULE

Argentina



Brazil



Customer Information

Djibouti

AGREE PAR LE MCPT (REPUBLIQUE DE DJIBOUTI)
Numéro d'agrément : 059/DDTIC/2020
Date d'agrément : 01/10/2020

Ghana

NCA APPROVED: SRO-1M-7E4-X13

EAC Marking - Russia, Belarus, Kazakhstan



Europe Union EU



Independent State Of Samoa



Israel

1. מספר אישור התאמה מסוג משרד התקשורת: 51-82320
2. חל אישור לבצע פעולות במכשיר שיש בהן כדי לשנות את תכונותיו האלחוטיות של המכשיר, ובכלל זה שינוי תוכנה, החלפת אנטנה מקורית או חוספת אפשרות לחיבור לאנטנה ניידנית, בלא קבלת אישור משרד התקשורת, בשל החשש להפרעת אלחוטיות.

Customer Information

Jamaica

This product has been Type Approved by Jamaica: SMA – F3TR.

Mexico

IFT: RCPAPF320-0479

Moldova



Malaysia



HIDF16000009

Mauritania

AGREE PAR L'ANE MAURITANIE
Numéro d'agrément : 0835/ARE/2020
Date d'agrément : 31/08/2020

Morocco

AGREE PAR L'ANRT MAROC

Numéro d'agrément:
MR00030034ANRT2021

Date d'agrément: 16/09/2021

Pakistan



Customer Information

Paraguay



NR: 2020-10-I-0752

Sierra Leone



TAN: 2021-002-0028

Singapore

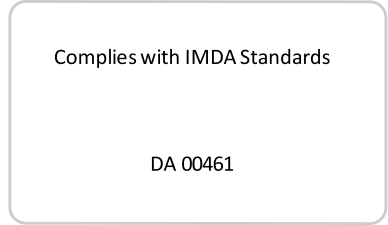

South Africa



South Korea



R-C-1Ap-F3TR

Customer Information

Taiwan



Unites Arab Emirates (U.A.E.)

TRA
REGISTERED NO: ER80143/20
DEALER NO: DA83047/19

Thailand

- (1) เครื่องนี้โทรคมนาคมและอยู่บริเวณนี้ มีความสอดคล้องตามข้อกำหนดของ กทท.
- (2) เครื่องนี้ระบุหมายเลขมีระดับการแก้ไขเพิ่มเติมแก้ไขให้สอดคล้องตามมาตรฐานความปลอดภัยของสุขภาพของมนุษย์
จากการใช้เครื่องวิทยุคมนาคมที่คณะกรรมการกิจการโทรคมนาคมแห่งชาติประกาศกำหนด

United Kingdom



Ukraine



United States and Canada

 **WARNING:** Changes or modifications not expressly approved by the party responsible for compliance could void the user's authority to operate the equipment. The term "IC:" before the radio certification number only signifies that Industry Canada technical specifications were met.

FCC ID: L2CF3TR
IC: 3432A-F3TR

Customer Information

This device complies with Part 15 of the FCC Rules and with Innovation, Science and Economic Development Canada's licence-exempt RSS(s). Operation is subject to the following two conditions:

1. This device may not cause harmful interference, and
2. This device must accept any interference received, including interference that may cause undesired operation.

Zambia



KEYS AND REMOTE CONTROLS

Argentina



Brazil



Customer Information

European Union EU

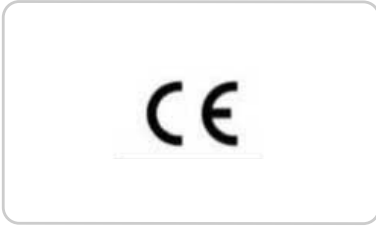

NR: 2016-9-I-000220

NR: 2016-9-I-000223

Pakistan



Jamaica

This product has been Type Approved by Jamaica: SMA – M3N-A2C931423



Paraguay



NR: 2017-10-I-0000334

NR: 2018-07-I-000317

Taiwan



Customer Information

 CCAB14LP563AT4

United Arab Emirates (U.A.E.)

TRA
REGISTERED No:
ER37535/15

DEALER No:
DA37380/15

TRA
REGISTERED NO: ER49357/16
DEALER NO: DA37380/15

TRA
REGISTERED No: ER47690/16
DEALER No: DA37380/15

TRA
REGISTERED NO: ER46754/16
DEALER NO: DA37380/15

United Kingdom

**UK
CA**

Customer Information

United States and Canada



WARNING: Changes or modifications not expressly approved by the party responsible for compliance could void the user's authority to operate the equipment. The term "IC:" before the radio certification number only signifies that Industry Canada technical specifications were met.

FCC ID: M3N-A3C054338

FCC ID: M3N-A3C054339

FCC ID: N5F-A08TAA

FCC ID: N5F-A08TDA

FCC ID: M3N-A2C931423

IC: 7812A-A3C054338

IC: 7812A-A3C054339

IC: 3248A-A08TAA

IC: 3248A-A08TDA

IC: 7812A-A2C931423

This device complies with Part 15 of the FCC Rules and with Innovation, Science and Economic Development Canada's licence-exempt RSS(s). Operation is subject to the following two conditions:

1. This device may not cause harmful interference, and
2. This device must accept any interference received, including interference that may cause undesired operation.

PASSIVE ANTI-THEFT SYSTEM

Argentina

CNC COMISIÓN NACIONAL
DE COMUNICACIONES
CNC ID: H-20723

CNC COMISIÓN NACIONAL
DE COMUNICACIONES

CNC ID: H-26283

Brazil

 **ANATEL**

Agência Nacional de Telecomunicações

03485-18-03199

Customer Information

Europe



Israel

1. מספר אישור התאמה מסעם משרד התקשורת: 51-63481
2. תל איסור לכצע פטולות במכשיר שיש בן דוד לשנות את תכונותו האלחוטיות של המכשיר, ובכלל זה שנויי תוכנה, החלפת אנטנה מקורית או הוספת אפשרות לחיבור לאנטנה חיצונית, בלא קבלת אישור משרד התקשורת, בשל החשש להפרעות אלחוטיות.

Jamaica



Ghana



Moldova



Customer Information

Morocco

AGREE PAR L'ANRT MAROC
Numéro d'agrément : MR 14721 ANRT 2017
Date d'agrément : 12/09/2017

Singapore

Complies with IMDA Standards

N0650-18

Paraguay



NR: 2018-04-I-000175

Serbia

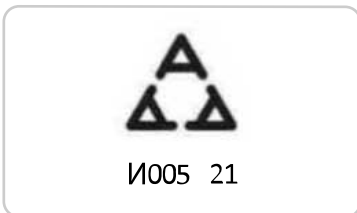

South Africa



South Korea



MSIP- R-RMM-OAC-OUC26006559

Customer Information

Taiwan

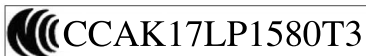

United States of America and Canada

 **WARNING:** Changes or modifications not expressly approved by the party responsible for compliance could void the user's authority to operate the equipment. The term "IC:" before the radio certification number only signifies that Industry Canada technical specifications were met.

FCC ID: OUC26006559

IC: 850K-26006559

This device complies with Part 15 of the FCC Rules and with Innovation, Science and Economic Development Canada's licence-exempt RSS(s). Operation is subject to the following two conditions:

1. This device may not cause harmful interference, and
2. This device must accept any interference received, including interference that may cause undesired operation.

Ukraine



Zambia

United Arab Emirates (U.A.E.)

TRA
REGISTERED No: ER95949/21
DEALER No: DA37380/15



Customer Information

RADIO TRANSCEIVER MODULE

Djibouti

AGREE PAR LE MCPT (REPUBLIQUE DE DJIBOUTI)
Numéros d'agrément : 033/DDTIC/2020
Date d'agrément : 07/06/2020

Europe Union (EU)



Ghana

NCA APPROVED: SRO-1M-7E4-108

Jamaica

This product has been Type Approved by
Jamaica: SMA - FO1-RX315UDA.

Mauritania



Mexico

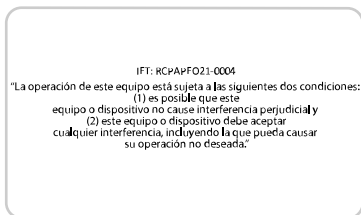

Moldova



Customer Information

Morocco

AGREE PAR L'ANE MAROC
Numéro d'agrément : MR 24102 ANRT 2020
Date d'agrément : 18/05/2020

Serbia



И011 20

Pakistan



South Africa



Samoa



Taiwan

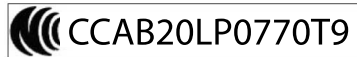

Customer Information

Ukraine



United Arab Emirates (U.A.E.)

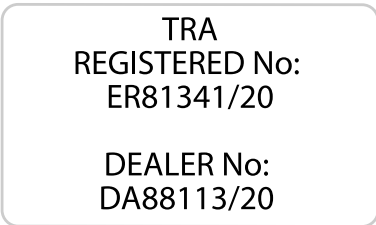

United Kingdom



United States and Canada

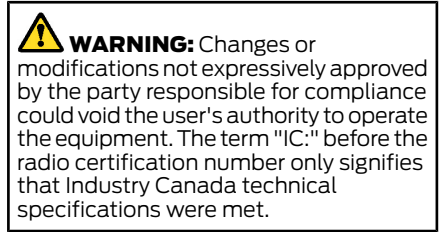

FCC ID: L2C0082R

FCC ID: L2C0083TR

IC: 3432A-0082R

IC: 3432A-0083TR

This device complies with Part 15 of the FCC Rules and with Innovation, Science and Economic Development Canada's licence-exempt RSS(s). Operation is subject to the following two conditions:

1. This device may not cause harmful interference, and
2. This device must accept any interference received, including interference that may cause undesired operation.

Zambia



Customer Information

SYNC

Argentina



08658-19-01505

**Este equipamento não tem direito à proteção
contra interferência prejudicial e não pode causar
interferência em sistemas devidamente autorizados.**



Djibouti

AGREE PAR LE MCPT (REPUBLIQUE DE DJIBOUTI)

Numéro d'agrément : 124/DDTIC/2019

Date d'agrément : 07/08/2019

Brazil



08657-19-01505

AGREE PAR LE MCPT (REPUBLIQUE DE DJIBOUTI)

Numéro d'agrément : 125/DDTIC/2019

Date d'agrément : 07/08/2019

**Este equipamento não tem direito à proteção
contra interferência prejudicial e não pode causar
interferência em sistemas devidamente autorizados.**

Customer Information

European Union EU

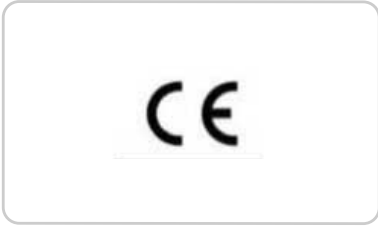

Model: SYNC-G4L
Sertifikat Nomor: **81116**/SDPPI/2022
PLG ID: 13493



Ghana

NCA APPROVED: ZRO-1H-7E3-182

NCA APPROVED: ZRO-1H-7E3-180

Indonesia

Model: SYNC-G4
Sertifikat Nomor: 80700/SDPPI/2022
PLG ID: 13493



Jamaica

This product has been Type Approved by
Jamaica: SMA – SYNC-G4.

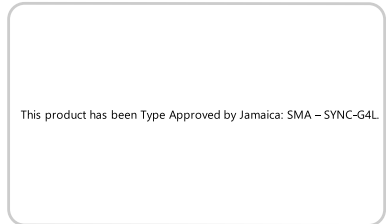

Customer Information

Malaysia



SQASI/TA/19/4047

SQASI/TA/19/4046

Mauritania

AGREE PAR L'ANE MAURITANIE

Numéro d'agrément : 0692/ARE/2018

Date d'agrément : 08/08/2019

AGREE PAR L'ANE MAURITANIE
Numéro d'agrément : 0691/ARE/2018
Date d'agrément : 08/08/2019

Moldova



Morocco

AGREE PAR L'ANRT MAROC
N° D'AGRÈMENT: MR 20608 ANRT 2019
07 AOUT 2019

AGREE PAR L'ANRT MAROC
N° D'AGRÈMENT: MR 20606 ANRT 2019
07 AOUT 2019

Customer Information

Pakistan



Singapore

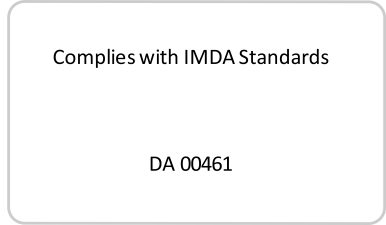

Paraguay



2020-03-I-00192

2020-03-I-00193

Serbia



South Africa



Customer Information

South Korea



MSIP-R-C-FDM-SYNGG4



MSIP-R-C-FDM-SYNGG4L

Ukraine



UA.TR.028

Taiwan

 CCAB20LP0290T8

 CCAB20LP0300T1

United Arab Emirates (U.A.E.)

UAE - TRA
REGISTERED No:
ER74902/19
DEALER No:
DA37380/15

TRA
REGISTERED No: ER74903/19
DEALER No: DA37380/15

Customer Information

United Kingdom



Zambia



United States and Canada



WARNING: Changes or modifications not expressly approved by the party responsible for compliance could void the user's authority to operate the equipment. The term "IC:" before the radio certification number only signifies that Industry Canada technical specifications were met.

FCC ID: KMH-SYNCG4

FCC ID: KMH-SYNCG4L

IC: 1422A-SYNCG4

IC: 1422A-SYNCG4L

This device complies with Part 15 of the FCC Rules and with Innovation, Science and Economic Development Canada's licence-exempt RSS(s). Operation is subject to the following two conditions:

1. This device may not cause harmful interference, and
2. This device must accept any interference received, including interference that may cause undesired operation.



TELEMATICS CONTROL UNIT

Argentina

The CNC logo consists of the letters 'CNC' in a bold, black, sans-serif font, with a red dot above the 'C'. To the right of the logo is the text 'COMISIÓN NACIONAL DE COMUNICACIONES' in a smaller, black, sans-serif font.

CNC COMISIÓN NACIONAL
DE COMUNICACIONES

Customer Information

C-28150

Brazil



Europe Union EU

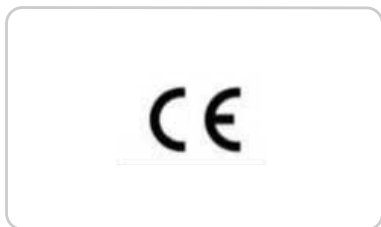

Mexico



South Africa



Taiwan

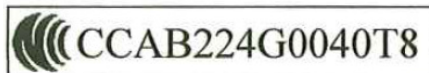

We recommend that the distance between the antenna of the telematics control unit and the user be greater than 14 in (35 cm) when using the telematics control unit.

United Arab Emirates (U.A.E.)

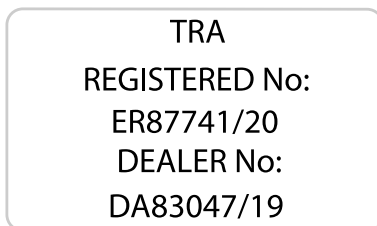

Customer Information

United Kingdom



Vietnam

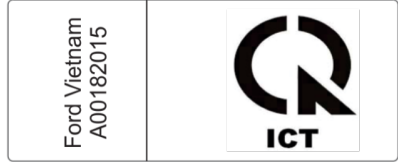

United States and Canada



WARNING: Changes or modifications not expressly approved by the party responsible for compliance could void the user's authority to operate the equipment. The term "IC:" before the radio certification number only signifies that Industry Canada technical specifications were met.

FCC ID: KMH-14H074-NA1

IC: 1422A-14H074NA1

This device complies with Part 15 of the FCC Rules and with Innovation, Science and Economic Development Canada's licence-exempt RSS(s). Operation is subject to the following two conditions:

1. This device may not cause harmful interference, and
2. This device must accept any interference received, including interference that may cause undesired operation.

TIRE PRESSURE MONITORING SYSTEM SENSORS

Argentina



Brazil



Customer Information

Jamaica

This product has been Type Approved by Jamaica: SMA – FP3

Mexico

IFT: RLVSCFP16-1400
"La operación de este equipo está sujeta a las siguientes dos condiciones:
(1) es posible que este
equipo o dispositivo no cause interferencia perjudicial y
(2) este equipo o dispositivo debe aceptar
cualquier interferencia, incluyendo la que pueda causar
su operación no deseada."

Paraguay



United Kingdom



United States and Canada

 **WARNING:** Changes or modifications not expressly approved by the party responsible for compliance could void the user's authority to operate the equipment. The term "IC:" before the radio certification number only signifies that Industry Canada technical specifications were met.

FCC ID: MRXFP3

IC: 2546A-FP3

This device complies with Part 15 of the FCC Rules and with Innovation, Science and Economic Development Canada's licence-exempt RSS(s). Operation is subject to the following two conditions:

1. This device may not cause harmful interference, and
2. This device must accept any interference received, including interference that may cause undesired operation.

Customer Information

WIRELESS ACCESSORY CHARGING MODULE

Argentina

CNC COMISIÓN NACIONAL
DE COMUNICACIONES

CNCID: H-26491

CNC COMISIÓN NACIONAL
DE COMUNICACIONES

CNCID: H-26492

CNC COMISIÓN NACIONAL
DE COMUNICACIONES

CNCID: H-26493

Brazil



Agência Nacional de Telecomunicações

12804-21-14208

Democratic Republic of Congo

Agréé par l'ARPTC

N° d'homologation : HER-0054/Juin/2021

Date d'homologation : 02/06/2021

European Union



Customer Information

Ghana

Model: WCFDM00N2A5
Sertifikat Nomor: 80112/SDPPI/2022
PLG ID: 13493

NCA APPROVED: 7ES-7M-XB1-RDR



Indonesia

Model: WCFDM00N2A1
Sertifikat Nomor: 80110/SDPPI/2022
PLG ID: 13493



Model: WCFDM00N2A3
Sertifikat Nomor: 80111/SDPPI/2022
PLG ID: 13493



Israel

1. מספר אישור החאמה מטעם משרד התקשורת: 51-80014
2. חל אישור לבצע פעולות במכשיר שיש בו די לשנות את תכונותיו האלחוטיות של המכשיר, ובכלל זה שינוי תכנה, החלפת אנטנה מקורית או הוספת אפשרות לחיבור לאנטנה חיצונית, בלא קבלת אישור משרד התקשורת, בשל החשש להפרעת אלחוטיות

1. מספר אישור החאמה מטעם משרד התקשורת: 51-80015
2. חל אישור לבצע פעולות במכשיר שיש בו די לשנות את תכונותיו האלחוטיות של המכשיר, ובכלל זה שינוי תכנה, החלפת אנטנה מקורית או הוספת אפשרות לחיבור לאנטנה חיצונית, בלא קבלת אישור משרד התקשורת, בשל החשש להפרעת אלחוטיות

1. מספר אישור החאמה מטעם משרד התקשורת: 51-80013
2. חל אישור לבצע פעולות במכשיר שיש בו די לשנות את תכונותיו האלחוטיות של המכשיר, ובכלל זה שינוי תכנה, החלפת אנטנה מקורית או הוספת אפשרות לחיבור לאנטנה חיצונית, בלא קבלת אישור משרד התקשורת, בשל החשש להפרעת אלחוטיות

Customer Information

Jamaica

This product has been Type Approved by Jamaica:
SMA - WCFDM00N2A.

AGREE PAR L'ANE MAURITANIE
Numéro d'agrément : 0934/ARE/2021
Date d'agrément : 23/03/2021

Malaysia



AGREE PAR L'ANE MAURITANIE
Numéro d'agrément : 0933/ARE/2021
Date d'agrément : 23/03/2021

RGEZ/35A/0521/S(21-2033)
RGEZ/35A/0521/S(21-2032)
RGEZ/35A/0521/S(21-2031)

Mauritania

AGREE PAR L'ANE MAURITANIE
Numéro d'agrément : 0935/ARE/2021
Date d'agrément : 23/03/2021

Moldova



Customer Information

Morocco

AGREE PAR L'ANRT MAROC
Numéro d'agrément : MR 00027924ANRT 2021
Date d'agrément : 25/03/2021

AGREE PAR L'ANRT MAROC
Nu méro d'agrément : MR 00027925ANRT 2021
Date d'agrément : 25/03/2021

AGREE PAR L'ANRT MAROC
Nu méro d'agrément : MR 00027923ANRT 2021
Date d'agrément : 25/03/2021

Paraguay



NR: 2021-04-I-0202

NR: 2021-04-I-0203

NR: 2021-04-I-0204

Russia



Serbia



V005 21

Customer Information

Sierra Leone



TAN: 2021-002-0099

South Korea



R-R-LGE-WCFDM00N2A1

Singapore

Complies with IMDA Standards

DA 00461

Taiwan

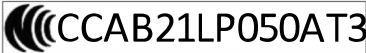

South Africa

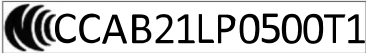

Customer Information

 CCAB21LP050BT5

品名 (Product name): 無線充電座

型號 (Type Designation): WCFDM00N2A1, WCFDM00N2A3, WCFDM00N2A5 **產地 (Origin):** 馬來西亞

額定電壓 (Input rating): 12V

製造日期 (Approval date): 2021.04.21



R43208
Rolls

申請廠商名稱 (Approval name): 福特六和汽車股份有限公司

申請廠商地址 (Approval address): 桃園市中壢區中華路一段705號

Ukraine



United Kingdom

**UK
CA**

United Arab Emirates (U.A.E.)

TRA REGISTERED No:

ER98638/21

DEALER No:

DA37380/15

Customer Information

TRA REGISTERED No:

ER00421/21

DEALER No:

DA37380/15

TRA REGISTERED No:

ER00422/21

DEALER No:

DA37380/15

United States and Canada

FCC ID: BEJWCDFM00N2A

IC: 2703H-WCFDM00N2A

This equipment generates, uses, and can radiate radio frequency energy and may cause harmful interference to radio communications. There is no guarantee that interference will not occur in a particular installation. If this equipment does cause harmful interference to radio or television reception, please consult the dealer.

This product is not end-user serviceable.

RF Radiation Exposure Statement: This equipment complies with FCC RF Radiation exposure limits set forth for an uncontrolled environment. This device and its antenna must not be co-located or operating in conjunction with any other antenna or transmitter. This equipment should be installed and operated with a minimum distance of 20cm between the radiator and your body.

This device complies with Part 15 of the FCC Rules and with Innovation, Science and Economic Development Canada's licence-exempt RSS(s). Operation is subject to the following two conditions:

1. This device may not cause harmful interference, and
2. This device must accept any interference received, including interference that may cause undesired operation.

Le présent appareil est conforme aux CNR d'Industrie Canada applicables aux appareils radio exempts de licence. L'exploitation est autorisée aux deux conditions suivantes:

1. *L'appareil ne doit pas produire de brouillage;*
2. *L'appareil doit accepter tout brouillage radioélectrique subi, même si le brouillage est susceptible d'en compromettre le fonctionnement.*

Customer Information

Zambia



PERCHLORATE

Certain components in your vehicle such as airbag modules, seatbelt pretensioners and remote control batteries may contain perchlorate material. Special handling may apply for service or vehicle end of life disposal.

For more information visit:
www.dtsc.ca.gov/hazardouswaste/perchlorate.

REPLACEMENT PARTS RECOMMENDATION

We have built your vehicle to the highest standards using quality parts. We recommend that you demand the use of genuine Ford and Motorcraft parts whenever your vehicle requires scheduled maintenance or repair. You can clearly identify genuine Ford and Motorcraft parts by looking for the Ford, FoMoCo or Motorcraft branding on the parts or their packaging.

Scheduled Maintenance and Mechanical Repairs

One of the best ways for you to make sure that your vehicle provides years of service is to have it maintained in line with our recommendations using parts that conform to the specifications detailed in this Owner's Manual.

Genuine Ford and Motorcraft parts meet or exceed these specifications.

Collision Repairs

We hope that you never experience a collision, but accidents happen sometimes.

Genuine Ford replacement collision parts meet our stringent requirements for fit, finish, structural integrity, corrosion protection and dent resistance. During vehicle development we validate that these parts deliver the intended level of protection as a whole system. A great way to know for sure you are getting this level of protection is to use genuine Ford replacement collision parts.

Warranty on Replacement Parts

Genuine Ford and Motorcraft replacement parts are the only replacement parts that benefit from a Ford Warranty.

The Ford Warranty may not cover damage caused to your vehicle as a result of failed non-Ford parts.

For additional information, refer to the terms and conditions of the Ford Warranty.

Customer Information

MOBILE COMMUNICATIONS EQUIPMENT



WARNING: Driving while distracted can result in loss of vehicle control, crash and injury. We strongly recommend that you use extreme caution when using any device that may take your focus off the road. Your primary responsibility is the safe operation of your vehicle. We recommend against the use of any hand-held device while driving and encourage the use of voice-operated systems when possible. Make sure you are aware of all applicable local laws that may affect the use of electronic devices while driving.

Using mobile communications equipment is becoming increasingly important in the conduct of business and personal affairs. However, you must not compromise your own or others' safety when using such equipment. Mobile communications can enhance personal safety and security when appropriately used, particularly in emergency situations. Safety must be paramount when using mobile communications equipment to avoid negating these benefits. Mobile communication equipment includes, but is not limited to, cellular phones, pagers, portable email devices, text messaging devices and portable two-way radios.

FEDERAL HIGHWAY ADMINISTRATION REGULATION

Regulations such as those issued by the Federal Highway Administration or issued pursuant to the Occupational Safety and Health Act (OSHA), and state and local laws and regulations may require additional equipment for the way you intend to use your vehicle. It is the responsibility of the registered owner to determine the applicability of such laws and regulations to your intended use for the vehicle, and to arrange for the installation of required equipment. The dealer has information about the availability of equipment which can be ordered for your vehicle.

Customer Information

END USER LICENSE AGREEMENT

VEHICLE SOFTWARE END USER LICENSE AGREEMENT (EULA)

- You ("You" or "Your" as applicable) have acquired a vehicle having several devices, including SYNC ® and various control modules, ("DEVICES") that include software licensed or owned by Ford Motor Company and its affiliates ("FORD MOTOR COMPANY"). Those software products of FORD MOTOR COMPANY origin, as well as associated media, printed materials, and "online" or electronic documentation ("SOFTWARE") are protected by international intellectual property laws and treaties. The SOFTWARE is licensed, not sold. All rights reserved.
- The SOFTWARE may interface with and/or communicate with, or may be later upgraded to interface with and/or communicate with additional software and/or systems provided by FORD MOTOR COMPANY.

IF YOU DO NOT AGREE TO THIS END USER LICENSE AGREEMENT ("EULA") DO NOT USE THE DEVICES OR COPY THE SOFTWARE. ANY USE OF THE SOFTWARE, INCLUDING BUT NOT LIMITED TO USE ON THE DEVICES, WILL CONSTITUTE YOUR AGREEMENT TO THIS EULA (OR RATIFICATION OF ANY PREVIOUS CONSENT).

GRANT OF SOFTWARE LICENSE: This EULA grants you the following license:

- You may use the SOFTWARE as installed on the DEVICES and as otherwise interfacing with systems and/or services provide by or through FORD MOTOR COMPANY or its third party software and service providers.

Description of Other Rights and Limitations.

- **Speech Recognition:** If the SOFTWARE includes speech recognition component(s), you should understand that speech recognition is an inherently statistical process and that recognition errors are inherent in the process. Neither FORD MOTOR COMPANY nor its suppliers shall be liable for any damages arising out of errors in the speech recognition process. It is your responsibility to monitor any speech recognition functions included in the system.
- **Limitations on Reverse Engineering, Decompilation and Disassembly:** You may not reverse engineer, decompile, translate, disassemble or attempt to discover any source code or underlying ideas or algorithms of the SOFTWARE nor permit others to reverse engineer, decompile or disassemble the SOFTWARE, except and only to the extent that such activity is expressly permitted by applicable law notwithstanding this limitation or to the extent as may be permitted by the licensing terms governing use of any open source components included with the SOFTWARE.
- **Limitations on Distributing, Copying, Modifying and Creating Derivative Works:** You may not distribute, copy, make modifications to or create derivative works based on the SOFTWARE, except and only to the extent that such activity is expressly permitted by applicable law notwithstanding this limitation or to the extent as may be permitted by the licensing terms governing use of any open source components included with the SOFTWARE.

Customer Information

- **Single EULA:** The end user documentation for the DEVICES and related systems and services may contain multiple EULAs, such as multiple translations and/or multiple media versions (e.g., in the user documentation and in the software). Even if you receive multiple EULAs, you are licensed to use only one (1) copy of the SOFTWARE.
- **SOFTWARE Transfer:** You may permanently transfer your rights under this EULA only as part of a sale or transfer of the DEVICES, provided you retain no copies, you transfer all of the SOFTWARE (including all component parts, the media and printed materials, any upgrades, and, if applicable, the Certificate(s) of Authenticity), and the recipient agrees to the terms of this EULA. If the SOFTWARE is an upgrade, any transfer must include all prior versions of the SOFTWARE.
- **Termination:** Without prejudice to any other rights, FORD MOTOR COMPANY may terminate this EULA if you fail to comply with the terms and conditions of this EULA.
- **Internet-Based Services Components:** The SOFTWARE may contain components that enable and facilitate the use of certain Internet-based services. You acknowledge and agree that FORD MOTOR COMPANY, third party software and service suppliers, its affiliates and/or its designated agent may automatically check the version of the SOFTWARE and/or its components that you are utilizing and may provide upgrades or supplements to the SOFTWARE that may be automatically downloaded to your DEVICES.
- **Additional Software/Services:** The SOFTWARE may permit FORD MOTOR COMPANY, third party software and service suppliers, its affiliates and/or its designated agent to provide or make available to you SOFTWARE updates, supplements, add-on components, or Internet-based services components of the SOFTWARE after the date you obtain your initial copy of the SOFTWARE ("Supplemental Components".) SOFTWARE updates may cause you to incur additional charges from your wireless service provider. If FORD MOTOR COMPANY or third party software and services suppliers provide or make available to you Supplemental Components and no other EULA terms are provided along with the Supplemental Components, then the terms of this EULA shall apply. FORD MOTOR COMPANY, its affiliates and/or its designated agent reserve the right to discontinue without liability any Internet-based services provided to you or made available to you through the use of the SOFTWARE.

Customer Information

- **Links to Third Party Sites:** The SOFTWARE may provide you with the ability to link to third party sites. The third party sites are not under the control of FORD MOTOR COMPANY, its affiliates and/or its designated agent. Neither FORD MOTOR COMPANY nor its affiliates nor its designated agent are responsible for (i) the contents of any third party sites, any links contained in third party sites, or any changes or updates to third party sites, or (ii) webcasting or any other form of transmission received from any third party sites. If the SOFTWARE provides links to third party sites, those links are provided to you only as a convenience, and the inclusion of any link does not imply an endorsement of the third party site by FORD MOTOR COMPANY, its affiliates and/or its designated agent.
- **Obligation to Drive Responsibly:** You recognize your obligation to drive responsibly and keep attention on the road. You will read and abide with the DEVICES operating instructions particularly as they pertain to safety and you agree to assume any risk associated with the use of the DEVICES.

UPGRADES AND RECOVERY MEDIA:

If the SOFTWARE is provided by FORD MOTOR COMPANY separate from the DEVICES on media such as a ROM chip, CD ROM disk(s) or via web download or other means, and is labeled "For Upgrade Purposes Only" or "For Recovery Purposes Only" you may install one (1) copy of such SOFTWARE onto the DEVICES as a replacement copy for the existing SOFTWARE, and use it in accordance with this EULA, including any additional EULA terms accompanying the upgrade SOFTWARE.

INTELLECTUAL PROPERTY RIGHTS:

All title and intellectual property rights in and to the SOFTWARE (including but not limited to any images, photographs, animations, video, audio, music, text and "applets" incorporated into the SOFTWARE), the accompanying printed materials, and any copies of the SOFTWARE, are owned by FORD MOTOR COMPANY, or its affiliates or suppliers. The SOFTWARE is licensed, not sold. You may not copy the printed materials accompanying the SOFTWARE. All title and intellectual property rights in and to the content which may be accessed through use of the SOFTWARE is the property of the respective content owner and may be protected by applicable copyright or other intellectual property laws and treaties. This EULA grants you no rights to use such content outside its intended use. All rights not specifically granted under this EULA are reserved by FORD MOTOR COMPANY, its affiliates, and third party software and service providers and suppliers. Use of any on-line services which may be accessed through the SOFTWARE may be governed by the respective terms of use relating to such services. If this SOFTWARE contains documentation that is provided only in electronic form, you may print one copy of such electronic documentation.

EXPORT RESTRICTIONS: You acknowledge that the SOFTWARE is subject to U.S. and European Union export jurisdiction. You agree to comply with all applicable international and national laws that apply to the SOFTWARE, including the U.S. Export Administration Regulations, as well as end-user, end-use and destination restrictions issued by U.S. and other governments.

Customer Information

TRADEMARKS: This EULA does not grant you any rights in connection with any trademarks or service marks of FORD MOTOR COMPANY, its affiliates, and third party software and service providers.

PRODUCT SUPPORT: Please refer to FORD MOTOR COMPANY instructions provided in the documentation for the DEVICES product support, such as the vehicle owner guide.

Should you have any questions concerning this EULA, or if you desire to contact FORD MOTOR COMPANY for any other reason, please refer to the address provided in the documentation for the DEVICES.

No Liability for Certain Damages: EXCEPT AS PROHIBITED BY LAW, FORD MOTOR COMPANY, ANY THIRD PARTY SOFTWARE OR SERVICES SUPPLIERS, AND THEIR AFFILIATES SHALL HAVE NO LIABILITY FOR ANY INDIRECT, SPECIAL, CONSEQUENTIAL OR INCIDENTAL DAMAGES ARISING FROM OR IN CONNECTION WITH THE USE OR PERFORMANCE OF THE SOFTWARE. THIS LIMITATION SHALL APPLY EVEN IF ANY REMEDY FAILS OF ITS ESSENTIAL PURPOSE. THERE ARE NO WARRANTIES OTHER THAN THOSE THAT MAY BE EXPRESSLY PROVIDED FOR YOUR NEW VEHICLE.

SYNC® Automotive Important Safety Information Read and follow instructions:

- Before using your SYNC® system, read and follow all instructions and safety information provided in this end user manual ("Owner Guide".) Not following precautions found in the Owner Guide can lead to an accident or other serious injuries.

General Operation

- **Voice Command Control:** Certain functions within the SYNC® system may be accomplished using voice commands. Using voice commands while driving helps you to operate the system without removing your hands from the wheel or eyes from the road.
- **Prolonged Views of Screen:** Do not access any function requiring a prolonged view of the screen while you are driving. Pull over in a safe and legal manner before attempting to access a function of the system requiring prolonged attention.
- **Volume Setting:** Do not raise the volume excessively. Keep the volume at a level where you can still hear outside traffic and emergency signals while driving. Driving while unable to hear these sounds could cause an accident.
- **Navigation Features:** Any navigation features included in the system are intended to provide turn by turn instructions to get you to a desired destination. Please make certain all persons using this system carefully read and follow instructions and safety information fully.
- **Distraction Hazard:** Any navigation features may require manual (non-verbal) setup. Attempting to perform such set-up or insert data while driving can distract your attention and could cause an accident or other serious injury. Stop the vehicle in a safe and legal manner before attempting these operations.
- **Let Your Judgment Prevail:** Any navigation features are provided only as an aid. Make your driving decisions based on your observations of local conditions and existing traffic regulations. Any such feature is not a

Customer Information

substitute for your personal judgment. Any route suggestions made by this system should never replace any local traffic regulations or your personal judgment or knowledge of safe driving practices.

- **Route Safety:** Do not follow the route suggestions if doing so would result in an unsafe or illegal maneuver, if you would be placed in an unsafe situation, or if you would be directed into an area that you consider unsafe. The driver is ultimately responsible for the safe operation of the vehicle and therefore, must evaluate whether it is safe to follow the suggested directions.
- **Potential Map Inaccuracy:** Maps used by this system may be inaccurate because of changes in roads, traffic controls or driving conditions. Always use good judgment and common sense when following the suggested routes.
- **Emergency Services:** Do not rely on any navigation features included in the system to route you to emergency services. Ask local authorities or an emergency services operator for these locations. Not all emergency services such as police, fire stations, hospitals and clinics are likely to be contained in the map database for such navigation features.

Your Responsibilities and Assumptions of Risk

- You agree to each of the following:(a) Any use of the SOFTWARE while driving an automobile or other vehicle in violation of applicable law or otherwise driving in an unsafe manner presents a significant risk of distracted driving and should not be attempted under any circumstances;(b) Use of the SOFTWARE at excessive volume poses a significant risk of hearing damage and should not be attempted under any circumstances;(c) The SOFTWARE may not be compatible with new or different versions of an operating system, third party software, or third party services, and the SOFTWARE may potentially cause a critical failure of an operating system, third party software, or third party service.(d) Any third party service accessed by or third party software used with the SOFTWARE (i) may charge an additional fee for access, (ii) may not work correctly, on an uninterrupted basis, or error free, (iii) may change streaming formats or discontinue operation, (iv) may contain adult, profane or offensive content; and (v) may contain inaccurate, false or misleading traffic, weather, financial or safety information or other content; and (e) Use of the SOFTWARE may cause you to incur additional charges from your wireless service provider (WSP) and any data or minute calculators that may be included in the software program are for reference only, are not warranted in any way and should not be relied upon in anyway.
- When using the SOFTWARE, you agree to be responsible for and assume the entire risk to the items set forth in Section (a) – (e) above.

Customer Information

Disclaimer of Warranty

YOU EXPRESSLY ACKNOWLEDGE AND AGREE THAT USE OF THE DEVICES AND SOFTWARE IS AT YOUR SOLE RISK AND THAT THE ENTIRE RISK AS TO SATISFACTORY QUALITY, PERFORMANCE, COMPATIBILITY, ACCURACY AND EFFORT IS WITH YOU. TO THE MAXIMUM EXTENT PERMITTED BY APPLICABLE LAW, THE SOFTWARE AND ANY THIRD PARTY SOFTWARE OR THIRD-PARTY SERVICES ARE PROVIDED "AS IS" AND "AS AVAILABLE", WITH ALL FAULTS AND WITHOUT WARRANTY OF ANY KIND, AND FORD MOTOR COMPANY HEREBY DISCLAIMS ALL WARRANTIES AND CONDITIONS WITH RESPECT TO THE SOFTWARE, THIRD PARTY SOFTWARE, AND THIRD-PARTY SERVICES, EITHER EXPRESS, IMPLIED OR STATUTORY, INCLUDING, BUT NOT LIMITED TO, THE IMPLIED WARRANTIES AND/OR CONDITIONS OF MERCHANTABILITY, OF SATISFACTORY QUALITY, OF FITNESS FOR AN PARTICULAR PURPOSE, OF ACCURACY, OF QUIET ENJOYMENT, AND NON-INFRINGEMENT OF THIRD-PARTY RIGHTS. FORD MOTOR COMPANY DOES NOT WARRANT (a) AGAINST INTERFERENCE WITH YOUR ENJOYMENT OF THE SOFTWARE, THIRD PARTY SOFTWARE, OR THIRD-PARTY SERVICES, (b) THAT THE SOFTWARE, THIRD PARTY SOFTWARE, OR THIRD-PARTY SERVICES WILL MEET YOUR REQUIREMENTS, (c) THAT THE OPERATION OF THE SOFTWARE, THIRD PARTY SOFTWARE, OR THIRD-PARTY SERVICES WILL BE UNINTERRUPTED OR ERROR-FREE, (d) OR THAT DEFECTS IN THE SOFTWARE, THIRD PARTY SOFTWARE, OR THIRD-PARTY SERVICES WILL BE CORRECTED. NO ORAL OR WRITTEN INFORMATION OR ADVICE GIVEN BY FORD MOTOR COMPANY OR ITS AUTHORIZED REPRESENTATIVE SHALL

CREATE A WARRANTY. SHOULD THE SOFTWARE, THIRD PARTY SOFTWARE, OR THIRD-PARTY SERVICES PROVE DEFECTIVE, YOU ASSUME THE ENTIRE COST OF ALL NECESSARY SERVICING, REPAIR OR CORRECTION. SOME JURISDICTIONS DO NOT ALLOW THE DISCLAIMER OF IMPLIED WARRANTIES OR LIMITATIONS ON APPLICABLE STATUTORY RIGHTS OF A CONSUMER, SO THE ABOVE DISCLAIMER MAY NOT FULLY APPLY TO YOU. THE SOLE WARRANTY PROVIDED BY FORD MOTOR COMPANY SHALL BE FOUND IN THE WARRANTY INFORMATION INCLUDING WITH YOUR OWNER GUIDE. TO THE EXTENT THAT THERE IS ANY CONFLICT BETWEEN THE TERMS OF THIS SECTION AND THE WARRANTY BOOKLET, THE WARRANTY BOOKLET SHALL CONTROL.

Applicable Law, Venue, Jurisdiction

- The laws of the State of Michigan govern this EULA and Your use of the SOFTWARE. Your use of the SOFTWARE may also be subject to other local, state, national, or international laws. Any litigation arising out of or related to this EULA shall be brought and maintained exclusively in a court of the State of Michigan located in Wayne County or in the United States District Court for the Eastern District of Michigan. You hereby consent to submit to the personal jurisdiction of a court in the State of Michigan located in Wayne County and the United States District Court for the Eastern District of Michigan for any dispute arising out of or relating to this EULA.

Customer Information

Binding Arbitration and Class Action Waiver

(a) Application. This Section applies to any dispute EXCEPT IT DOES NOT INCLUDE A DISPUTE RELATING TO COPYRIGHT INFRINGEMENT, OR TO THE ENFORCEMENT OR VALIDITY OF YOUR, FORD MOTOR COMPANY, OR ANY OF FORD MOTOR COMPANY'S LICENSORS' INTELLECTUAL PROPERTY RIGHTS.

Dispute means any dispute, action, or other controversy between You and FORD MOTOR COMPANY, other than the exceptions listed above, concerning the SOFTWARE (including its price) or this EULA, whether in contract, warranty, tort, statute, regulation, ordinance, or any other legal or equitable basis.

(b) Notice of Dispute. In the event of a Dispute, You or FORD MOTOR COMPANY must give the other a "Notice of Dispute", which is a written statement of the name, address, and contact information of the party giving it, the facts giving rise to the dispute, and the relief requested. You and FORD MOTOR COMPANY will attempt to resolve any dispute through informal negotiation within 60 days from the date the Notice of Dispute is sent. After 60 days, You or FORD MOTOR COMPANY may commence arbitration.

(c) Small claims court. You may also litigate any dispute in small claims court in your county of residence or FORD MOTOR COMPANY'S principal place of business, if the dispute meets all requirements to be heard in the small claims court. You may litigate in small claims court whether or not You negotiated informally first.

(d) Binding arbitration. If You and FORD MOTOR COMPANY, do not resolve any dispute by informal negotiation or in small claims court, any other effort to resolve the dispute will be conducted exclusively by binding arbitration. You are giving up

the right to litigate (or participate in as a party or class member) all disputes in court before a judge or jury. Instead, all disputes will be resolved before a neutral arbitrator, whose decision will be final except for a limited right of appeal under the Federal Arbitration Act. Any court with jurisdiction over the parties may enforce the arbitrator's award.

(e) Class action waiver. Any proceedings to resolve or litigate any dispute in any forum will be conducted solely on an individual basis. Neither you nor FORD MOTOR COMPANY, will seek to have any dispute heard as a class action, as a private attorney general action, or in any other proceeding in which any party acts or proposes to act in a representative capacity. No arbitration or proceeding will be combined with another without the prior written consent of all parties to all affected arbitrations or proceedings.

(f) Arbitration procedure. Any arbitration will be conducted by the American Arbitration Association (the "AAA"), under its Commercial Arbitration Rules. If You are an individual and use the SOFTWARE for personal or vehicle use, or if the value of the dispute is \$75,000 or less whether or not You are an individual or how You use the SOFTWARE, the AAA Supplementary Procedures for Consumer-Related Disputes will also apply. To commence arbitration, submit a Commercial Arbitration Rules Demand for Arbitration form to the AAA. You may request a telephonic or in-person hearing by following the AAA rules. In a dispute involving \$10,000 or less, any hearing will be telephonic unless the arbitrator finds good cause to hold an in-person hearing instead. For more information, see adr.org or call 1-800-778-7879. You agree to commence arbitration only in your county of residence or FORD MOTOR COMPANY'S principal place of business. The arbitrator

Customer Information

may award the same damages to you individually as a court could. The arbitrator may award declaratory or injunctive relief only to you individually, and only to the extent required to satisfy your individual claim.

(g) Arbitration fees and incentives.

- i. Disputes involving \$75,000 or less. FORD MOTOR COMPANY will promptly reimburse your filing fees and pay the AAA's and arbitrator's fees and expenses. If you reject FORD MOTOR COMPANY'S last written settlement offer made before the arbitrator was appointed ("last written offer"), your dispute goes all the way to an arbitrator's decision (called an "award"), and the arbitrator awards you more than the last written offer, FORD MOTOR COMPANY will give you three incentives: (1) pay the greater of the award or \$1,000; (2) pay twice your reasonable attorney's fees, if any; and (3) reimburse any expenses (including expert witness fees and costs) that your attorney reasonably accrues for investigating, preparing, and pursuing your claim in arbitration. The arbitrator will determine the amounts.
- ii. Disputes involving more than \$75,000. The AAA rules will govern payment of filing fees and the AAA's and arbitrator's fees and expenses.
- iii. Disputes involving any amount. In any arbitration you commence, FORD MOTOR COMPANY will seek its AAA or arbitrator's fees and expenses, or Your filing fees it reimbursed, only if the arbitrator finds the arbitration frivolous or brought for an improper purpose. In any arbitration FORD MOTOR COMPANY commences, it will pay all

filing, AAA, and arbitrator's fees and expenses. It will not seek its attorney's fees or expenses from you in any arbitration. Fees and expenses are not counted in determining how much a dispute involves.

(h) Claims or disputes must be filed within one year. To the extent permitted by law, any claim or dispute under this EULA to which this Section applies must be filed within one year in small claims court (Section c) or in arbitration (Section d). The one-year period begins when the claim or dispute first could be filed. If such a claim or dispute is not filed within one year, it is permanently barred.

(i) Severability. If the class action waiver (Section e) is found to be illegal or unenforceable as to all or some parts of a dispute, then that portion of Section e will not apply to those parts. Instead, those parts will be severed and proceed in a court of law, with the remaining parts proceeding in arbitration. If any other provision of that portion Section e is found to be illegal or unenforceable, that provision will be severed with the remainder of Section e remaining in full force and effect.

Telenav Software End User License Agreement

Please read these terms and conditions carefully before you use the TeleNav Software. Your use of the TeleNav Software indicates that you accept these terms and conditions. If you do not accept these terms and conditions, do not break the seal of the package, launch, or otherwise use the TeleNav Software. TeleNav may revise this Agreement and the privacy policy at any time, with or without notice to you. You agree to visit <http://www.telenav.com> from time to time to review the then current version of this Agreement and of the privacy policy.

Customer Information

1. Safe and Lawful Use

You acknowledge that devoting attention to the TeleNav Software may pose a risk of injury or death to you and others in situations that otherwise require your undivided attention, and you therefore agree to comply with the following when using the TeleNav Software:

- (a) observe all traffic laws and otherwise drive safely;
- (b) use your own personal judgment while driving. If you feel that a route suggested by the TeleNav Software instructs you to perform an unsafe or illegal maneuver, places you in an unsafe situation, or directs you into an area that you consider to be unsafe, do not follow such instructions;
- (c) do not input destinations, or otherwise manipulate the TeleNav Software, unless your vehicle is stationary and parked;
- (d) do not use the TeleNav Software for any illegal, unauthorized, unintended, unsafe, hazardous, or unlawful purposes, or in any manner inconsistent with this Agreement;
- (e) arrange all GPS and wireless devices and cables necessary for use of the TeleNav Software in a secure manner in your vehicle so that they will not interfere with your driving and will not prevent the operation of any safety device (such as an airbag).

You agree to indemnify and hold TeleNav harmless against all claims resulting from any dangerous or otherwise inappropriate use of the TeleNav Software in any moving vehicle, including as a result of your failure to comply with the directions above.

2. Account Information

You agree: (a) when registering the TeleNav Software, to provide TeleNav with true, accurate, current, and complete information about yourself, and (b) to inform TeleNav promptly of any changes to such information, and to keep it true, accurate, current and complete.

3. Software License

- Subject to your compliance with the terms of this Agreement, TeleNav hereby grants to you a personal, non-exclusive, non-transferable license (except as expressly permitted below in connection with your permanent transfer of the TeleNav Software license), without the right to sublicense, to use the TeleNav Software (in object code form only) in order to access and use the TeleNav Software. This license shall terminate upon any termination or expiration of this Agreement. You agree that you will use the TeleNav Software only for your personal business or leisure purposes, and not to provide commercial navigation services to other parties.

3.1 License Limitations

- **(a)** reverse engineer, decompile, disassemble, translate, modify, alter or otherwise change the TeleNav Software or any part thereof; **(b)** attempt to derive the source code, audio library or structure of the TeleNav Software without the prior express written consent of TeleNav; **(c)** remove from the TeleNav Software, or alter, any of TeleNav's or its suppliers' trademarks, trade names, logos, patent or copyright notices, or other notices or markings; **(d)**

Customer Information

distribute, sublicense or otherwise transfer the TeleNav Software to others, except as part of your permanent transfer of the TeleNav Software; or **(e)** use the TeleNav Software in any manner that

- i. infringes the intellectual property or proprietary rights, rights of publicity or privacy or other rights of any party,
- ii. violates any law, statute, ordinance or regulation, including but not limited to laws and regulations related to spamming, privacy, consumer and child protection, obscenity or defamation, or
- iii. is harmful, threatening, abusive, harassing, tortuous, defamatory, vulgar, obscene, libelous, or otherwise objectionable; and (f) lease, rent out, or otherwise permit unauthorized access by third parties to the TeleNav Software without advanced written permission of TeleNav.

4. Disclaimers

- To the fullest extent permissible pursuant to applicable law, in no event will TeleNav, its licensors and suppliers, or agents or employees of any of the foregoing, be liable for any decision made or action taken by you or anyone else in reliance on the information provided by the TeleNav Software. TeleNav also does not warrant the accuracy of the map or other data used for the TeleNav Software. Such data may not always reflect reality due to, among other things, road closures, construction, weather, new roads and other changing conditions. You are responsible for the entire risk arising out of your use of the TeleNav Software. For example but without limitation, you agree not to rely on the TeleNav Software for critical navigation in areas where the well-being or survival of you or others

is dependent on the accuracy of navigation, as the maps or functionality of the TeleNav Software are not intended to support such high risk applications, especially in more remote geographical areas.

- TELENAV EXPRESSLY DISCLAIMS AND EXCLUDES ALL WARRANTIES IN CONNECTION WITH THE TELENAV SOFTWARE, WHETHER STATUTORY, EXPRESS OR IMPLIED, INCLUDING ALL WARRANTIES WHICH MAY ARISE FROM COURSE OF DEALING, CUSTOM OR TRADE AND INCLUDING, BUT NOT LIMITED TO, THE IMPLIED WARRANTIES OF MERCHANTABILITY, FITNESS FOR A PARTICULAR PURPOSE AND NON-INFRINGEMENT OF THIRD PARTY RIGHTS WITH RESPECT TO THE TELENAV SOFTWARE.
- Certain jurisdictions do not permit the disclaimer of certain warranties, so this limitation may not apply to you.

5. Limitation of Liability

- TO THE EXTENT PERMITTED UNDER APPLICABLE LAW, UNDER NO CIRCUMSTANCES SHALL TELENAV OR ITS LICENSORS AND SUPPLIERS BE LIABLE TO YOU OR TO ANY THIRD PARTY FOR ANY INDIRECT, INCIDENTAL, CONSEQUENTIAL, SPECIAL OR EXEMPLARY DAMAGES (INCLUDING IN EACH CASE, BUT NOT LIMITED TO, DAMAGES FOR THE INABILITY TO USE THE EQUIPMENT OR ACCESS DATA, LOSS OF DATA, LOSS OF BUSINESS, LOSS OF PROFITS, BUSINESS INTERRUPTION OR THE LIKE) ARISING OUT OF THE USE OF OR INABILITY TO USE THE TELENAV SOFTWARE, EVEN IF TELENAV HAS BEEN ADVISED OF THE POSSIBILITY OF SUCH DAMAGES. NOTWITHSTANDING ANY DAMAGES THAT YOU MIGHT INCUR FOR ANY

Customer Information

REASON WHATSOEVER (INCLUDING, WITHOUT LIMITATION, ALL DAMAGES REFERENCED HEREIN AND ALL DIRECT OR GENERAL DAMAGES IN CONTRACT, TORT (INCLUDING NEGLIGENCE) OR OTHERWISE), THE ENTIRE LIABILITY OF TELENAV AND OF ALL OF TELENAV'S SUPPLIERS SHALL BE LIMITED TO THE AMOUNT ACTUALLY PAID BY YOU FOR THE TELENAV SOFTWARE. SOME STATES AND/OR JURISDICTIONS DO NOT ALLOW THE EXCLUSION OR LIMITATION OF INCIDENTAL OR CONSEQUENTIAL DAMAGES, SO THE ABOVE LIMITATIONS OR EXCLUSIONS MAY NOT APPLY TO YOU.

6. Arbitration and Governing Law

- You agree that any dispute, claim or controversy arising out of or relating to this Agreement or the TeleNav Software shall be settled by independent arbitration involving a neutral arbitrator and administered by the American Arbitration Association in the County of Santa Clara, California. The arbitrator shall apply the Commercial Arbitration Rules of the American Arbitration Association, and the judgment upon the award rendered by the arbitrator may be entered by any court having jurisdiction. Note that there is no judge or jury in an arbitration proceeding and the decision of the arbitrator shall be binding upon both parties. You expressly agree to waive your right to a jury trial. This Agreement and performance hereunder will be governed by and construed in accordance with the laws of the State of California, without giving effect to its conflict of law provisions. To the extent judicial action is necessary in connection with the binding arbitration, both TeleNav and you agree to submit

to the exclusive jurisdiction of the courts of the County of Santa Clara, California. The United Nations Convention on Contracts for the International Sale of Goods shall not apply.

7. Assignment

- You may not resell, assign, or transfer this Agreement or any of your rights or obligations, except in totality, in connection with your permanent transfer of the TeleNav Software, and expressly conditioned upon the new user of the TeleNav Software agreeing to be bound by the terms and conditions of this Agreement. Any such sale, assignment or transfer that is not expressly permitted under this paragraph will result in immediate termination of this Agreement, without liability to TeleNav, in which case you and all other parties shall immediately cease all use of the TeleNav Software. Notwithstanding the foregoing, TeleNav may assign this Agreement to any other party at any time without notice, provided the assignee remains bound by this Agreement.

8. Miscellaneous

8.1

This Agreement constitutes the entire agreement between TeleNav and you with respect to the subject matter hereof.

8.2

Except for the limited licenses expressly granted in this Agreement, TeleNav retains all right, title and interest in and to the TeleNav Software, including without limitation all related intellectual property rights. No licenses or other rights which are not expressly granted in this Agreement are intended to, or shall be, granted or

Customer Information

conferred by implication, statute, inducement, estoppel or otherwise, and TeleNav and its suppliers and licensors hereby reserve all of their respective rights other than the licenses explicitly granted in this Agreement.

8.3

By using the TeleNav Software, you consent to receive from TeleNav all communications, including notices, agreements, legally required disclosures or other information in connection with the TeleNav Software (collectively, "Notices") electronically. TeleNav may provide such Notices by posting them on TeleNav's Website or by downloading such Notices to your wireless device. If you desire to withdraw your consent to receive Notices electronically, you must discontinue your use of the TeleNav Software.

8.4

TeleNav's or your failure to require performance of any provision shall not affect that party's right to require performance at any time thereafter, nor shall a waiver of any breach or default of this Agreement constitute a waiver of any subsequent breach or default or a waiver of the provision itself.

8.5

If any provision herein is held unenforceable, then such provision will be modified to reflect the intention of the parties, and the remaining provisions of this Agreement will remain in full force and effect.

8.6

The headings in this Agreement are for convenience of reference only, will not be deemed to be a part of this Agreement, and will not be referred to in connection with the construction or interpretation of this Agreement. As used in this Agreement, the words "include" and "including" and variations thereof, will not be deemed to be terms of limitation, but rather will be deemed to be followed by the words "without limitation".

9. Other Vendors Terms and Conditions

- The Telenav Software utilizes map and other data licensed to Telenav by third party vendors for the benefit of you and other end users. This Agreement includes end-user terms applicable to these companies (included at the end of this Agreement), and thus your use of the Telenav Software is also subject to such terms. You agree to comply with the following additional terms and conditions, which are applicable to Telenav's third party vendor licensors.

9.1 End User Terms Required by HERE North America, LLC

The data ("Data") is provided for your personal, internal use only and not for resale. It is protected by copyright, and is subject to the following terms and conditions which are agreed to by you, on the one hand, and Telenav ("Telenav") and its licensors (including their licensors and suppliers) on the other hand.

© 2013 HERE. All rights reserved.

The Data for areas of Canada includes information taken with permission from Canadian authorities, including: © Her Majesty the Queen in Right of Canada, © Queen's Printer for Ontario, © Canada Post Corporation, GeoBase®, © Department of Natural Resources Canada.

Customer Information

HERE holds a non-exclusive license from the United States Postal Service® to publish and sell ZIP+4® information.

©United States Postal Service® 2014. Prices are not established, controlled or approved by the United States Postal Service®. The following trademarks and registrations are owned by the USPS: United States Postal Service, USPS, and ZIP+4

The Data for Mexico includes certain data from Instituto Nacional de Estadística y Geografía.

9.2 End User Terms Required by NAV2 (Shanghai) Co., Ltd

The data (“Data”) is provided for your personal, internal use only and not for resale. It is protected by copyright, and is subject to the following terms and conditions which are agreed to by you, on the one hand, and NAV2 (Shanghai) Co., Ltd (“NAV2”) and its licensors (including their licensors and suppliers) on the other hand. 20xx. All rights reserved

Terms and Conditions

Permitted Use. You agree to use this Data together with the Telenav Software solely for the internal business and personal purposes for which you were licensed, and not for service bureau, time-sharing or other similar purposes. Accordingly, but subject to the restrictions set forth in the following paragraphs, you agree not to otherwise reproduce, copy, modify, decompile, disassemble, create any derivative works of, or reverse engineer any portion of this Data, and may not transfer or distribute it in any form, for any purpose, except to the extent permitted by mandatory laws.

Restrictions. Except where you have been specifically licensed to do so by Telenav, and without limiting the preceding paragraph, you may not use this Data (a) with any products, systems, or applications installed or otherwise connected to or in communication with vehicles, capable of vehicle navigation, positioning, dispatch, real time route guidance, fleet management or similar applications; or (b) with or in communication with any positioning devices or any mobile or wireless-connected electronic or computer devices, including without limitation cellular phones, palmtop and handheld computers, pagers, and personal digital assistants or PDAs.

Warning. The Data may contain inaccurate or incomplete information due to the passage of time, changing circumstances, sources used and the nature of collecting comprehensive geographic data, any of which may lead to incorrect results.

No Warranty. This Data is provided to you “as is,” and you agree to use it at your own risk. Telenav and its licensors (and their licensors and suppliers) make no guarantees, representations or warranties of any kind, express or implied, arising by law or otherwise, including but not limited to, content, quality, accuracy, completeness, effectiveness, reliability, fitness for a particular purpose, usefulness, use or results to be obtained from this Data, or that the Data or server will be uninterrupted or error-free.

Disclaimer of Warranty: TELENAV AND ITS LICENSORS (INCLUDING THEIR LICENSORS AND SUPPLIERS) DISCLAIM ANY WARRANTIES, EXPRESS OR IMPLIED, OF QUALITY, PERFORMANCE, MERCHANTABILITY, FITNESS FOR A

Customer Information

PARTICULAR PURPOSE OR NON-INFRINGEMENT. Some States, Territories and Countries do not allow certain warranty exclusions, so to that extent the above exclusion may not apply to you.

Disclaimer of Liability: TELENAV AND ITS LICENSORS (INCLUDING THEIR LICENSORS AND SUPPLIERS) SHALL NOT BE LIABLE TO YOU: IN RESPECT OF ANY CLAIM, DEMAND OR ACTION, IRRESPECTIVE OF THE NATURE OF THE CAUSE OF THE CLAIM, DEMAND OR ACTION ALLEGING ANY LOSS, INJURY OR DAMAGES, DIRECT OR INDIRECT, WHICH MAY RESULT FROM THE USE OR POSSESSION OF THE INFORMATION; OR FOR ANY LOSS OF PROFIT, REVENUE, CONTRACTS OR SAVINGS, OR ANY OTHER DIRECT, INDIRECT, INCIDENTAL, SPECIAL OR CONSEQUENTIAL DAMAGES ARISING OUT OF YOUR USE OF OR INABILITY TO USE THIS INFORMATION, ANY DEFECT IN THE INFORMATION, OR THE BREACH OF THESE TERMS OR CONDITIONS, WHETHER IN AN ACTION IN CONTRACT OR TORT OR BASED ON A WARRANTY, EVEN IF TELENAV OR ITS LICENSORS HAVE BEEN ADVISED OF THE POSSIBILITY OF SUCH DAMAGES. Some States, Territories and Countries do not allow certain liability exclusions or damages limitations, so to that extent the above may not apply to you.

Export Control. You shall not export from anywhere any part of the Data or any direct product thereof except in compliance with, and with all licenses and approvals required under, applicable export laws, rules and regulations, including but not limited to the laws, rules and regulations administered by the Office of Foreign Assets Control of the U.S. Department of Commerce and the Bureau of Industry and Security of the U.S. Department of Commerce. To the extent that any such

export laws, rules or regulations prohibit HERE from complying with any of its obligations hereunder to deliver or distribute Data, such failure shall be excused and shall not constitute a breach of this Agreement.

Entire Agreement. These terms and conditions constitute the entire agreement between Telenav (and its licensors, including their licensors and suppliers) and you pertaining to the subject matter hereof, and supersedes in their entirety any and all written or oral agreements previously existing between us with respect to such subject matter.

Governing Law. The above terms and conditions shall be governed by the laws of the State of Illinois [insert "Netherlands" where European HERE Data is used], without giving effect to (i) its conflict of laws provisions, or (ii) the United Nations Convention for Contracts for the International Sale of Goods, which is explicitly excluded. You agree to submit to the jurisdiction of the State of Illinois [insert "The Netherlands" where European HERE Data is used] for any and all disputes, claims and actions arising from or in connection with the Data provided to you hereunder.

Government End Users. If the Data is being acquired by or on behalf of the United States government or any other entity seeking or applying rights similar to those customarily claimed by the United States government, this Data is a "commercial item" as that term is defined at 48 C.F.R. ("FAR") 2.101, is licensed in accordance with these End-User Terms, and each copy of Data delivered or otherwise furnished shall be marked and embedded as appropriate with the following "Notice of Use," and shall be treated in accordance with such Notice:

Customer Information

NOTICE OF USE

CONTRACTOR (MANUFACTURER/
SUPPLIER) NAME: HERE

CONTRACTOR (MANUFACTURER/
SUPPLIER) ADDRESS: c/o Nokia, 425
West Randolph Street, Chicago, Illinois
60606

This Data is a commercial item as
defined in FAR 2.101 and is subject to
these End-User Terms under which this
Data was provided.

© 1987 – 2014 HERE – All rights reserved.

If the Contracting Officer, federal government agency, or any federal official refuses to use the legend provided herein, the Contracting Officer, federal government agency, or any federal official must notify HERE prior to seeking additional or alternative rights in the Data.

I. US/Canada Territory

A. United States Data. The End-User Terms for any Application containing Data for the United States shall contain the following notices:

“HERE holds a non-exclusive license from the United States Postal Service® to publish and sell ZIP+4® information.”

“©United States Postal Service® 20XX. Prices are not established, controlled or approved by the United States Postal Service®. The following trademarks and registrations are owned by the USPS: United States Postal Service, USPS, and ZIP+4.”

B. Canada Data. The following provisions apply to the Data for Canada, which may include or reflect data from third party licensors (“Third Party Data”), including Her Majesty the Queen in Right of Canada (“Her Majesty”), Canada Post Corporation (“Canada Post”) and the Department of Natural Resources of Canada (“NRCan”):

1. Disclaimer and Limitation: Client agrees that its use of the Third Party Data is subject to the following provisions:

a. Disclaimer: The Third Party Data is licensed on an “as is” basis. The licensors of such data, including Her Majesty, Canada Post and NRCan, make no guarantees, representations or warranties respecting such data, either express or implied, arising by law or otherwise, including but not limited to, effectiveness, completeness, accuracy or fitness for a particular purpose.

b. Limitation on Liability: The Third Party Data licensors, including Her Majesty, Canada Post and NRCan, shall not be liable: (i) in respect of any claim, demand or action, irrespective of the nature of the cause of the claim, demand or action alleging any loss, injury or damages, direct or indirect, which may result from the use or possession of such Data; or (ii) in any way for loss of revenues or contracts, or any other consequential loss of any kind resulting from any defect in the Data.

Customer Information

2. Copyright Notice: In connection with each copy of all or any portion of the Data for the Territory of Canada, Client shall affix in a conspicuous manner the following copyright notice on at least one of: (i) the label for the storage media of the copy; (ii) the packaging for the copy; or (iii) other materials packaged with the copy, such as user manuals or end user license agreements: "This data includes information taken with permission from Canadian authorities, including © Her Majesty the Queen in Right of Canada, © Queen's Printer for Ontario, © Canada Post Corporation, GeoBase®, © The Department of Natural Resources Canada. All rights reserved."

3. End-User Terms: Except as otherwise agreed by the parties, in connection with the provision of any portion of the Data for the Territory of Canada to End-Users as may be authorized under the Agreement, Client shall provide such End-Users, in a reasonably conspicuous manner, with terms (set forth with other end user terms required to be provided under the Agreement, or as otherwise may be provided, by Client) which shall include the following provisions on behalf of the Third Party Data licensors, including Her Majesty, Canada Post and NRCan:

The Data may include or reflect data of licensors, including Her Majesty the Queen in the Right of Canada ("Her Majesty"), Canada Post Corporation ("Canada Post") and the Department of Natural Resources Canada ("NRCan"). Such data is licensed on an "as is" basis. The licensors, including Her Majesty, Canada Post and NRCan, make no guarantees, representations or warranties respecting such data,

either express or implied, arising by law or otherwise, including but not limited to, effectiveness, completeness, accuracy or fitness for a particular purpose. The licensors, including Her Majesty, Canada Post and NRCan, shall not be liable in respect of any claim, demand or action, irrespective of the nature of the cause of the claim, demand or action alleging any loss, injury or damages, direct or indirect, which may result from the use or possession of the data or the Data. The licensors, including Her Majesty, Canada Post and NRCan, shall not be liable in any way for loss of revenues or contracts, or any other consequential loss of any kind resulting from any defect in the data or the Data.

End User shall indemnify and save harmless the licensors, including Her Majesty, Canada Post and NRCan, and their officers, employees and agents from and against any claim, demand or action, irrespective of the nature of the cause of the claim, demand or action, alleging loss, costs, expenses, damages or injuries (including injuries resulting in death) arising out of the use or possession of the data or the Data.

4. Additional Provisions: The terms contained in this Section are in addition to all of the rights and obligations of the parties under the Agreement. To the extent that any of the provisions of this Section are inconsistent with, or conflict with, any other provisions of the Agreement, the provisions of this Section shall prevail.

Customer Information

II. Mexico. The following provision applies to the Data for Mexico, which includes certain data from the Instituto Nacional de Estadística y Geografía (“INEGI”):

A. Any and all copies of the Data and/or packaging containing Data for Mexico shall contain the following notice: “Fuente: INEGI (Instituto Nacional de Estadística y Geografía)”

III. Latin America Territory

A. Third Party Notices. Any and all copies of the Data and/or packaging relating thereto shall include the respective Third Party Notices set forth below and used as described below corresponding to the Territory (or portion thereof) included in such copy:

Territory	Notice
Argentina	IGN “INSTITUTO GEOGRAFICO NACIONAL ARGENTINO”
Ecuador	“INSTITUTO GEOGRAFICO MILITAR DEL ECUADOR AUTORIZACION N° IGM-2011-01- PCO-01 DEL 25 DE ENERO DE 2011” “source: © IGN 2009 - BD TOPO ®”
Guadeloupe, French Guiana and Martinique	“Fuente: INEGI (Instituto Nacional de Estadística y Geografía)”

IV. Middle East Territory

A. Third Party Notices. Any and all copies of the Data and/or packaging relating thereto shall include the respective Third Party Notices set forth below and used as described below corresponding to the Territory (or portion thereof) included in such copy:

Country	Notice
Jordan	“© Royal Jordanian Geographic Centre”. The foregoing notice requirement for Jordan Data is a material term of the Agreement. If Client or any of its permitted sublicensees (if any) fail to meet such requirement, HERE shall have the right to terminate Client’s license with respect to the Jordan Data.

B. Jordan Data. Client and its permitted sublicensees (if any) are restricted from licensing and/or otherwise distributing HERE’s database for the country of Jordan (“Jordan Data”) for use in Enterprise Applications to (i) non-Jordanian entities for use of the Jordan Data solely in Jordan or (ii) Jordan-based customers. In addition, Client, its permitted sublicensees (if any) and End-Users are restricted from using the Jordan Data in Enterprise Applications if such party is (i) a non-Jordanian entity using the Jordan Data solely in Jordan or (ii) a Jordan-based customer. For purposes of the foregoing, “Enterprise Applications” shall mean Geomarketing applications, GIS applications, mobile business asset management applications, call center applications, telematics applications, public organization Internet applications or for providing geocoding services.

Customer Information

V. Europe Territory

A. Use of Certain Traffic Codes in Europe

1. General Restrictions Applicable to Traffic Codes. Client acknowledges and agrees that in certain countries of the Europe Territory, Client will need to obtain rights directly from third party RDS-TMC code providers to receive and use the Traffic Codes in the Data and to deliver to End-Users Transactions in any way derived from or based on such Traffic Codes. For such countries, HERE shall deliver the Data incorporating Traffic Codes to Client only after receiving certification from Client of its having obtained such rights.

2. Display of Third Party Rights Legends for Belgium. Client shall, for each Transaction that uses Traffic Codes for Belgium, provide the following notice to the End-User: "Traffic Codes for Belgium are provided by the Ministerie van de Vlaamse Gemeenschap and the Ministère de l'Équipement et des Transports."

B. Paper Maps. With respect to any license granted to Client relating to making, selling or distributing paper maps (i.e., a map fixed on a paper or paper-like medium): (a) such license with respect to Data for the Territory of Great Britain is conditioned on Client's entering into and complying with a separate written agreement with the Ordnance Survey ("OS") to create and sell paper maps, Client's paying to the OS any and all applicable paper map royalties, and Client's complying with the OS copyright notice requirements; (b) such license for selling or otherwise distributing for charge with respect to Data for the Territory of Czech Republic

is conditioned on Client's obtaining prior written consent from Kartografie a.s.; (c) such license for selling or distributing with respect to Data for the Territory of Switzerland is conditioned on Client's obtaining a permit from Bundesamt für Landestopografie of Switzerland; (d) Client is restricted from using Data for the Territory of France to create paper maps with a scale between 1:5,000 and 1:250,000; and (e) Client is restricted from using any Data to create, sell or distribute paper maps that are the same or substantially similar, in terms of data content and specific use of color, symbols and scale, to paper maps published by the European national mapping agencies, including without limitation, Landvermessungämter of Germany, Topografische Dienst of the Netherlands, Nationaal Geografisch Instituut of Belgium, Bundesamt für Landestopografie of Switzerland, Bundesamt für Eich-und Vermessungswesen of Austria, and the National Land Survey of Sweden.

C. OS Enforcement. Without limiting Section IV(B) above, with respect to Data for the Territory of Great Britain, Client acknowledges and agrees that the Ordnance Survey ("OS") may bring a direct action against Client to enforce compliance with the OS copyright notice (see Section IV(D) below) and paper map requirements (see Section IV(B) above) contained in this Agreement.

D. Third Party Notices. Any and all copies of the Data and/or packaging relating thereto shall include the respective Third Party Notices set forth below and used as described below corresponding to the Territory (or portion thereof) included in such copy:

Country(ies) Notice

Customer Information

Austria	“© Bundesamt für Eich- und Vermessungswesen”	Spain	“Información geográfica propiedad del CNIG”
Croatia Cyprus, Estonia, Latvia, Lithuania, Moldova, Poland, Slovenia and/or Ukraine	“© EuroGeographics”	Sweden	“Based upon electronic data © National Land Survey Sweden.”
France	“source: © IGN 2009 – BD TOPO ®”	Switzerland	“Topografische Grundlage: © Bundesamt für Landestopographie.
Germany	“Die Grundlagendaten wurden mit Genehmigung der zuständigen Behörden entnommen”	E. Respective Country Distribution. Client acknowledges that HERE has not received approvals to distribute map data for the following countries in such respective countries: Albania, Belarus, Kyrgyzstan, Moldova and Uzbekistan. HERE may update such list from time to time. The license rights granted to Client under this TL with respect to the Data for such countries are contingent upon Client’s compliance with all applicable laws and regulations, including, without limitation, any required licenses or approvals to distribute the Application incorporating such Data in such respective countries.	
Great Britain	“Contains Ordnance Survey data © Crown copyright and database right 2010 Contains Royal Mail data © Royal Mail copyright and database right 2010”	VI. Australia Territory	A. Third Party Notices. Any and all copies of the Data and/or packaging relating thereto shall include the respective Third Party Notices set forth below and used as described below corresponding to the Territory (or portion thereof) included in such copy: Copyright. Based on data provided under license from PSMA Australia Limited (www.pasma.com.au).
Greece	“Copyright Geomatics Ltd.”		
Hungary	“Copyright © 2003; Top-Map Ltd.”		
Italy	“La Banca Dati Italiana è stata prodotta usando quale riferimento anche cartografia numerica ed al tratto prodotta e fornita dalla Regione Toscana.”		
Norway	“Copyright © 2000; Norwegian Mapping Authority”		
Portugal	“Source: IgeoE – Portugal”		

Customer Information

Product incorporates data which is © 20XX Telstra Corporation Limited, GM Holden Limited, Intelomatics Australia Pty Ltd and Continental Pty Ltd.

B. Third Party Notices for Australia. In addition to the foregoing, the End-User Terms for any Application containing RDS-TMC Traffic Codes for Australia shall contain the following notice: "Product incorporates traffic location codes which is © 20XX Telstra Corporation Limited and its licensors."

AT&T Vehicle Network Carrier Telematics Disclosure

END USER FOR PURPOSES OF THIS SECTION MEANS YOU AND YOUR HEIRS, EXECUTORS, LEGAL PERSONAL REPRESENTATIVES AND PERMITTED ASSIGNS. FOR PURPOSES OF THIS SECTION "UNDERLYING WIRELESS SERVICE CARRIER" INCLUDES ITS AFFILIATES AND CONTRACTORS AND THEIR RESPECTIVE OFFICERS, DIRECTORS, EMPLOYEES, SUCCESSORS AND ASSIGNS. END USER HAS NO CONTRACTUAL RELATIONSHIP WITH THE UNDERLYING WIRELESS SERVICE CARRIER AND END USER IS NOT A THIRD PARTY BENEFICIARY OF ANY AGREEMENT BETWEEN FORD AND UNDERLYING CARRIER. END USER UNDERSTANDS AND AGREES THAT THE UNDERLYING CARRIER HAS NO LEGAL, EQUITABLE, OR OTHER LIABILITY OF ANY KIND TO END USER. IN ANY EVENT, REGARDLESS OF THE FORM OF THE ACTION, WHETHER FOR BREACH OF CONTRACT, WARRANTY, NEGLIGENCE, STRICT LIABILITY IN TORT OR OTHERWISE, END USER'S EXCLUSIVE REMEDY FOR CLAIMS ARISING IN ANY WAY IN CONNECTION WITH THIS AGREEMENT, FOR ANY CAUSE WHATSOEVER, INCLUDING BUT NOT LIMITED TO ANY FAILURE OR

DISRUPTION OF SERVICE PROVIDED HEREUNDER, IS LIMITED TO PAYMENT OF DAMAGES IN AN AMOUNT NOT TO EXCEED THE AMOUNT PAID BY END USER FOR THE SERVICES DURING THE TWO-MONTH PERIOD PRECEDING THE DATE THE CLAIM AROSE.

(ii) END USER AGREES TO INDEMNIFY AND HOLD HARMLESS THE UNDERLYING WIRELESS SERVICE CARRIER AND ITS OFFICERS, EMPLOYEES, AND AGENTS AGAINST ANY AND ALL CLAIMS, INCLUDING WITHOUT LIMITATION CLAIMS FOR LIBEL, SLANDER, OR ANY PROPERTY DAMAGE, PERSONAL INJURY OR DEATH, ARISING IN ANY WAY, DIRECTLY OR INDIRECTLY, IN CONNECTION WITH THIS AGREEMENT OR THE USE, FAILURE TO USE, OR INABILITY TO USE THE DEVICE EXCEPT WHERE THE CLAIMS RESULT FROM THE UNDERLYING CARRIER'S GROSS NEGLIGENCE OR WILLFUL MISCONDUCT. THIS INDEMNITY WILL SURVIVE THE TERMINATION OF THE AGREEMENT.

(iii) END USER HAS NO PROPERTY RIGHT IN ANY NUMBER ASSIGNED TO THE DEVICE.

(iv) END USER UNDERSTANDS THAT FORD AND THE UNDERLYING CARRIER CANNOT GUARANTY THE SECURITY OF WIRELESS TRANSMISSIONS, AND WILL NOT BE LIABLE FOR ANY LACK OF SECURITY RELATING TO THE USE OF THE SERVICES

THE SERVICE IS FOR [END USER'S] USE ONLY AND END USER MAY NOT RESELL THE SERVICE TO ANY OTHER PARTY END USER UNDERSTANDS THAT THE UNDERLYING CARRIER DOES NOT GUARANTEE ANY END USER UNINTERRUPTED SERVICE OR COVERAGE. THE UNDERLYING CARRIER DOES NOT WARRANT THAT END USERS CAN OR WILL BE LOCATED USING THE SERVICE. THE UNDERLYING CARRIER

Customer Information

MAKES NO WARRANTY, EXPRESS OR IMPLIED, OF MERCHANTABILITY OR FITNESS FOR A PARTICULAR PURPOSE, SUITABILITY, OR PERFORMANCE REGARDING ANY SERVICES OR GOODS, AND IN NO EVENT SHALL AT&T BE LIABLE, WHETHER OR NOT DUE TO ITS OWN NEGLIGENCE, FOR ANY: (A) ACT OR OMISSION OF A THIRD PARTY; (B) MISTAKES, OMISSIONS, INTERRUPTIONS, ERRORS, FAILURES TO TRANSMIT, DELAYS, OR DEFECTS IN THE SERVICE PROVIDED BY OR THROUGH THE UNDERLYING CARRIER; (C) DAMAGE OR INJURY CAUSED BY SUSPENSION OR TERMINATION BY THE UNDERLYING CARRIER; OR (D) DAMAGE OR INJURY CAUSED BY A FAILURE OR DELAY IN CONNECTING A CALL TO ANY ENTITY, INCLUDING 911 OR ANY OTHER EMERGENCY SERVICE. TO THE FULL EXTENT ALLOWED BY LAW, THE END USER RELEASES, INDEMNIFIES AND HOLDS THE UNDERLYING CARRIER HARMLESS FROM AND AGAINST ANY AND ALL CLAIMS OF ANY PERSON OR ENTITY FOR DAMAGES OF ANY NATURE ARISING IN ANY WAY FROM OR RELATING TO, DIRECTLY OR INDIRECTLY, SERVICES PROVIDED BY THE UNDERLYING CARRIER OR ANY PERSON'S USE THEREOF, INCLUDING CLAIMS ARISING IN WHOLE OR IN PART FROM THE ALLEGED NEGLIGENCE OF THE UNDERLYING CARRIER.

VII. China Territory

Personal Use Only

You agree to use this Data together with [insert name of Client Application] for the solely personal, non-commercial purposes for which you were licensed, and not for service bureau, time-sharing or other similar purposes. Accordingly, but subject to the restrictions set forth in the following paragraphs, you may copy this Data only as necessary for your personal use to (i)

view it, and (ii) save it, provided that you do not remove any copyright notices that appear and do not modify the Data in any way. You agree not to otherwise reproduce, copy, modify, decompile, disassemble or reverse engineer any portion of this Data, and may not transfer or distribute it in any form, for any purpose, except to the extent permitted by mandatory laws.

Restrictions

Except where you have been specifically licensed to do so by NAV2, and without limiting the preceding paragraph, you may not (a) use this Data with any products, systems, or applications installed or otherwise connected to or in communication with vehicles, capable of vehicle navigation, positioning, dispatch, real time route guidance, fleet management or similar applications; or (b) with or in communication with any positioning devices or any mobile or wireless-connected electronic or computer devices, including without limitation cellular phones, palmtop and handheld computers, pagers, and personal digital assistants or PDAs. You agree to cease using this Data if you fail to comply with these terms and conditions.

Limited Warranty

NAV2 warrants that (a) the Data will perform substantially in accordance with the accompanying written materials for a period of ninety (90) days from the date of receipt, and (b) any support services provided by NAV2 shall be substantially as described in applicable written materials provided to you by NAV2, and NAV2's support engineers will make commercially reasonable efforts to solve any problem issues.

Customer Information

Customer Remedies

NAV2 and its suppliers' entire liability and your exclusive remedy shall be, at NAV2's sole discretion, either (a) return of the price paid, if any, or (b) repair or replacement of the Data that do not meet NAV2's Limited Warranty and that are returned to NAV2 with a copy of your receipt. This Limited Warranty is void if failure of the Data has resulted from accident, abuse, or misapplication. Any replacement Data will be warranted for the remainder of the original warranty period or thirty (30) days, whichever is longer. Neither these remedies nor any product support services offered by NAV2 are available without proof of purchase from an authorized international source.

No Other Warranty:

EXCEPT FOR THE LIMITED WARRANTY SET FORTH ABOVE AND TO THE EXTENT PERMITTED BY APPLICABLE LAW, NAV2 AND ITS LICENSORS (INCLUDING THEIR LICENSORS AND SUPPLIERS) DISCLAIM ANY WARRANTIES, EXPRESS OR IMPLIED, OF QUALITY, PERFORMANCE, MERCHANTABILITY, FITNESS FOR A PARTICULAR PURPOSE, OWNERSHIP OR NON-INFRINGEMENT. Certain warranty exclusions may not be permitted under applicable law, so to that extent the above exclusion may not apply to you.

Limited Liability:

TO THE EXTENT PERMITTED BY APPLICABLE LAW, NAV2 AND ITS LICENSORS (INCLUDING THEIR LICENSORS AND SUPPLIERS) SHALL NOT BE LIABLE TO YOU: IN RESPECT OF ANY CLAIM, DEMAND OR ACTION, IRRESPECTIVE OF THE NATURE OF THE CAUSE OF THE CLAIM, DEMAND OR ACTION ALLEGING ANY LOSS, INJURY OR DAMAGES, DIRECT OR INDIRECT, WHICH MAY RESULT FROM THE USE OR POSSESSION OF THE INFORMATION; OR

FOR ANY LOSS OF PROFIT, REVENUE, CONTRACTS OR SAVINGS, OR ANY OTHER DIRECT, INDIRECT, INCIDENTAL, SPECIAL OR CONSEQUENTIAL DAMAGES ARISING OUT OF YOUR USE OF OR INABILITY TO USE THIS INFORMATION, ANY DEFECT IN THE INFORMATION, OR THE BREACH OF THESE TERMS OR CONDITIONS, WHETHER IN AN ACTION IN CONTRACT OR TORT OR BASED ON A WARRANTY, EVEN IF NAV2 OR ITS LICENSORS HAVE BEEN ADVISED OF THE POSSIBILITY OF SUCH DAMAGES. UNDER NO CIRCUMSTANCES SHALL NAV2'S OR ITS SUPPLIERS' LIABILITY HEREUNDER EXCEED THE PRICE PAID. Certain liability exclusions may not be permitted under applicable law, so to that extent the above exclusion may not apply to you.

Export Control

You agree not to export to anywhere any part of the Data provided to you or any direct product thereof except in compliance with, and with all licenses and approvals required under, applicable export laws, rules and regulations.

IP Protection

The Data are owned by NAV2 or its suppliers and are protected by applicable copyright and other intellectual property law and treaties. The Data are provided solely on the basis of a license to use, not sale.

Entire Agreement

These terms and conditions constitute the entire agreement between NAV2 (and its licensors, including their licensors and suppliers) and you pertaining to the subject matter hereof, and supersedes in their entirety any and all written or oral agreements previously existing between us with respect to such subject matter.

Customer Information

Governing Law.

The above terms and conditions shall be governed by the laws of the People's Republic of China, without giving effect to (i) its conflict of laws provisions, or (ii) the United Nations Convention for Contracts for the International Sale of Goods, which is explicitly excluded. Any dispute arising from or in connection with the Data provided to you hereunder shall be submitted to the Shanghai International Economic and Trade Arbitration Commission for arbitration.

Gracenote® Copyright

CD and music-related data from Gracenote, Inc., copyright©

2000-2007 Gracenote. Gracenote Software, copyright © 2000-2007 Gracenote. This product and service may practice one or more of the following U.S. Patents 5,987,525; 6,061,680; 6,154,773; 6,161,132; 6,230,192; 6,230,207; 6,240,459; 6,330,593 and other patents issued or pending. Some services supplied under license from Open Globe, Inc. for U.S. Patent 6,304,523.

Gracenote and CDDb are registered trademarks of Gracenote. The Gracenote logo and logotype, and the "Powered by Gracenote™" logo are trademarks of Gracenote.

Gracenote® End User License Agreement (EULA)

This device contains software from Gracenote, Inc. of 2000 Powell Street Emeryville, California 94608 ("Gracenote").

The software from Gracenote (the "Gracenote Software") enables this device to do disc and music file identification and obtain music-related information, including name, artist, track, and title information ("Gracenote Data") from online servers

("Gracenote Servers"), and to perform other functions. You may use Gracenote Data only by means of the intended End User functions of this device. This device may contain content belonging to Gracenote's providers. If so, all of the restrictions set forth herein with respect to Gracenote Data shall also apply to such content and such content providers shall be entitled to all of the benefits and protections set forth herein that are available to Gracenote. You agree that you will use the content from Gracenote ("Gracenote Content"), Gracenote Data, the Gracenote Software, and Gracenote Servers for your own personal, non-commercial use only. You agree not to assign, copy, transfer or transmit the Gracenote Content, Gracenote Software or any Gracenote Data (except in a Tag associated with a music file) to any third party. YOU AGREE NOT TO USE OR EXPLOIT GRACENOTE CONTENT, GRACENOTE DATA, THE GRACENOTE SOFTWARE, OR GRACENOTE SERVERS, EXCEPT AS EXPRESSLY PERMITTED HEREIN.

You agree that your non-exclusive licenses to use the Gracenote Content, Gracenote Data, the Gracenote Software, and Gracenote Servers will terminate if you violate these restrictions. If your licenses terminate, you agree to cease any and all use of the Gracenote Content, Gracenote Data, the Gracenote Software, and Gracenote Servers.

Gracenote, respectively, reserve all rights in Gracenote Data, the Gracenote Software, and the Gracenote Servers and Gracenote Content, including all ownership rights. Under no circumstances will either Gracenote become liable for any payment to you for any information that you provide,

Customer Information

including any copyrighted material or music file information. You agree that Gracenote may enforce its respective rights, collectively or separately, under this agreement against you, directly in each company's own name.

Gracenote uses a unique identifier to track queries for statistical purposes. The purpose of a randomly assigned numeric identifier is to allow Gracenote to count queries without knowing anything about who you are. For more information, see the web page at www.gracenote.com for the Gracenote Privacy Policy.

THE GRACENOTE SOFTWARE, EACH ITEM OF GRACENOTE DATA AND THE GRACENOTE CONTENT ARE LICENSED TO YOU "AS IS". NEITHER GRACENOTE MAKES ANY REPRESENTATIONS OR WARRANTIES, EXPRESS OR IMPLIED, REGARDING THE ACCURACY OF ANY GRACENOTE DATA FROM THE GRACENOTE SERVERS OR GRACENOTE CONTENT. GRACENOTE COLLECTIVELY AND SEPARATELY RESERVE THE RIGHT TO DELETE DATA AND/OR CONTENT FROM THE COMPANIES' RESPECTIVE SERVERS OR, IN THE CASE OF GRACENOTE, CHANGE DATA CATEGORIES FOR ANY CAUSE THAT GRACENOTE DEEMS SUFFICIENT. NO WARRANTY IS MADE THAT EITHER GRACENOTE CONTENT OR THE GRACENOTE SOFTWARE OR GRACENOTE SERVERS ARE ERROR-FREE OR THAT THE FUNCTIONING OF THE GRACENOTE SOFTWARE OR GRACENOTE SERVERS WILL BE UNINTERRUPTED. GRACENOTE IS NOT OBLIGATED TO PROVIDE YOU WITH ANY ENHANCED OR ADDITIONAL DATA TYPES THAT GRACENOTE MAY CHOOSE TO PROVIDE IN THE FUTURE AND IS FREE TO DISCONTINUE ITS ONLINE SERVICES AT ANY TIME. GRACENOTE DISCLAIMS ALL WARRANTIES EXPRESS OR IMPLIED, INCLUDING, BUT NOT LIMITED TO,

IMPLIED WARRANTIES OF MERCHANTABILITY, FITNESS FOR A PARTICULAR PURPOSE, TITLE, AND NON-INFRINGEMENT. NEITHER GRACENOTE WARRANTS THE RESULTS THAT WILL BE OBTAINED BY YOUR USE OF THE GRACENOTE SOFTWARE OR ANY GRACENOTE SERVER. IN NO CASE WILL GRACENOTE BE LIABLE FOR ANY CONSEQUENTIAL OR INCIDENTAL DAMAGES OR FOR ANY LOST PROFITS OR LOST REVENUES FOR ANY REASON WHATSOEVER. © Gracenote 2007.

Taiwan Territory

According to the "Technical Specifications for Low Power Radio Frequency Equipment" formulated by the National Communications and Communication Committee of the Executive Yuan: 3.8.2. For the low-power radio frequency equipment that has obtained the verification certificate, the company, firm or user shall not change the frequency, increase the power or change the characteristics and functions of the original design without authorization.

The use of low-power radio frequency equipment must not affect flight safety and interfere with legal communications: when the system detects interference, immediately stop using it until there is no interference.

The aforementioned legal communication refers to the wireless communication operated in accordance with the provisions of the Telecommunications Management Law. Low-power radio frequency equipment needs to endure the interference of legal communication or industrial, scientific and medical radio wave radiation electrical equipment.

Customer Information

SUNA TRAFFIC CHANNEL – TERMS AND CONDITIONS

By activating, using and/or accessing the SUNA Traffic Channel, SUNA Predictive or other content or material provided by Intelematics (together, **SUNA Products and/or Services**), you must accept certain terms and conditions. The following is a brief summary of the terms and conditions that apply to you. To view the full terms and conditions relevant to your use of the SUNA Products and/or Services, please consult:

Website
www.sunattraffic.com.au/termsandconditions/

1. Acceptance

By using SUNA Products and/or Services, you will be deemed to have accepted and agreed to be bound by the terms and conditions fully detailed at:

Website
www.sunattraffic.com.au/termsandconditions/

2. Intellectual Property

SUNA Products and/or Services are for your personal use. You may not record, or retransmit the content, nor use the content in association with any other traffic information or route guidance service or device not approved by Intelematics. You obtain no right of ownership in any Intellectual Property Rights (including copyright) in the data that is used to provide SUNA Products and/or Services.

3. Appropriate Use

SUNA Products and/or Services are intended as an aid to personal motoring and travel planning, and do not provide comprehensive or accurate information on all occasions. On occasions, you may experience additional delay as a result of using SUNA Products and/or Services. You acknowledge that it is not intended, or suitable, for use in applications where time of arrival or driving directions may impact the safety of the public or yourself.

4. Use of SUNA Products and Services while driving

You, and other authorized drivers of the vehicle in which SUNA Products and/or Services are available or installed and active, remain at all times responsible for observing all relevant laws and codes of safe driving. In particular, you agree to only actively operate SUNA Products and/or Services when the Vehicle is at a complete stop and it is safe to do so.

5. Service Continuity and Reception of the SUNA Traffic Channel

We will use reasonable endeavors to provide the SUNA Traffic Channel 24 hours a day, 365 days a year. The SUNA Traffic Channel may occasionally be unavailable for technical reasons or for planned maintenance. We will try to perform maintenance at times when congestion is light. We reserve the right to withdraw SUNA Products and/or Services at any time.

Also, we cannot assure the uninterrupted reception of the SUNA Traffic Channel RDS-TMC signal at any particular location.

6. Limitation of Liability

Neither Intelematics (nor its suppliers or the manufacturer of your device (the **"Suppliers"**)) shall be liable to you or to any third party for any damages either direct, indirect, incidental, consequential or otherwise arising out of the use of or inability to use SUNA Products and/or

Customer Information

Services even if Intelematics or a Supplier has been advised of the possibility of such damages. You also acknowledge that neither Intelematics nor any Supplier guarantees nor make any warranties that relate to the availability, accuracy or completeness of SUNA Products and/or Services, and to the extent which it is lawful to do so, both Intelematics and each Supplier excludes any warranties which might otherwise be implied by any State or Federal legislation in relation to SUNA Products and/or Services.

7. Please Note

Great care has been taken in preparing this manual. Constant product development may mean that some information is not entirely up-to-date. The information in this document is subject to change without notice.

EMISSION LAW



WARNING: Do not remove or alter the original equipment floor covering or insulation between it and the metal floor of the vehicle. The floor covering and insulation protect occupants of the vehicle from the engine and exhaust system heat and noise. On vehicles with no original equipment floor covering insulation, do not carry passengers in a manner that permits prolonged skin contact with the metal floor. Failure to follow these instructions may result in fire or personal injury.

U.S. federal laws and certain state laws prohibit removing or rendering inoperative emission control system components. Similar federal or provincial laws may apply in Canada. We do not approve of any vehicle modification without first determining applicable laws.



Tampering with emissions control systems including related sensors or the Diesel Exhaust Fluid system can result in reduced engine power and the illumination of the service engine soon light.

Tampering With a Noise Control System

Federal laws prohibit the following acts:

- Removal or rendering inoperative by any person other than for purposes of maintenance.
- Repair or replacement of any device or element of the design incorporated into a new vehicle for the purpose of noise control prior to its sale or delivery to the ultimate purchaser or while it is in use.
- The use of the vehicle after any person removes or renders inoperative any device or element of the design.

The U.S. Environmental Protection Agency may presume to constitute tampering as follows:

- Removal of hood blanket, fender apron absorbers, fender apron barriers, underbody noise shields or acoustically absorptive material.
- Tampering or rendering inoperative the engine speed governor, to allow engine speed to exceed manufacturer specifications.

If the engine does not start, runs rough, experiences a decrease in engine performance, experiences excess fuel consumption or produces excessive exhaust smoke, check for the following:

- A plugged or disconnected air inlet system hose.
- A plugged engine air filter element.
- Water in the fuel filter and water separator.

Customer Information

- A clogged fuel filter.
- Contaminated fuel.
- Air in the fuel system, due to loose connections.
- An open or pinched sensor hose.
- Incorrect engine oil level.
- Incorrect fuel for climatic conditions.
- Incorrect engine oil viscosity for climatic conditions.

Note: *Some vehicles have a lifetime fuel filter that is integrated with the fuel tank. Regular maintenance or replacement is not needed.*

Note: *If these checks do not help you correct the concern, have your vehicle checked as soon as possible.*

Noise Emissions Warranty, Prohibited Tampering Acts and Maintenance

On January 1, 1978, Federal regulation became effective governing the noise emission on trucks over 10,000 lb (4,536 kg) Gross Vehicle Weight Rating (GVWR). The preceding statements concerning prohibited tampering acts and maintenance, and the noise warranty found in the Warranty Guide, are applicable to complete chassis cabs over 10,000 lb (4,536 kg) GVWR.

EXPORT UNIQUE OPTIONS

For your particular global region, your vehicle may be equipped with features and options that are different from the features and options that are described in this Owner's Manual. A market unique supplement may be supplied that complements this book. By referring to the market unique supplement, if provided, you can properly identify those features, recommendations and specifications that are unique to your vehicle. This Owner's

Manual is written primarily for the U.S. and Canadian markets. Features or equipment listed as standard may be different on units built for export. **Refer to this Owner's Manual for all other required information and warnings.**

WARRANTY INFORMATION

The following warranties may apply to your vehicle:

- New vehicle limited warranties.
- Emissions warranties, if applicable. (Note: Fully-electric vehicles are not eligible for emissions warranties.)
- Other warranties, if applicable.

Detailed warranty information specific to your vehicle can be found in the Warranty Guide at www.owner.ford.com.

The following California Warranty Statement, required by California regulations, applies to vehicles certified to California emissions standards and registered in a state that requires California emissions warranty. If applicable, additional California Emissions Warranties can be found in the Warranty Guide at www.owner.ford.com.

CALIFORNIA EMISSION CONTROL WARRANTY STATEMENT

YOUR WARRANTY RIGHTS AND OBLIGATIONS

The California Air Resources Board and Ford Motor Company are pleased to explain the emission control system warranty on your (year) vehicle. In California, new motor vehicles must be designated, built and equipped to meet

Customer Information

the State's stringent anti-smog standards. Ford Motor Company must warrant the emission control system on your vehicle for the periods of time listed below provided there has been no abuse, neglect or improper maintenance of your vehicle.

Your emission control system may include parts such as the carburetor or fuel-injection system, the ignition system, catalytic converter and engine computer. Also included may be hoses, belts, connectors and other emission-related assemblies. Where a warrantable condition exists, Ford Motor Company will repair your vehicle at no cost to you including diagnosis, parts and labor.

MANUFACTURER'S WARRANTY COVERAGE:

(For 1990 and subsequent model passenger cars, light-duty trucks, and medium-duty vehicles.)

- For 3 years or 50,000 miles (whichever occurs first);

1) If your vehicle fails a Smog Check inspection, all necessary repairs and adjustments will be made by Ford Motor Company to ensure that your emission control system **PERFORMANCE WARRANTY**.

2) If any emission-related part on your vehicle is defective, the part will be repaired or replaced by Ford Motor Company. This is your short-term emission control system **DEFECTS WARRANTY**.

- For 7 years or 70,000 miles (whichever occurs first);

1) If an emission-related part listed in this warranty booklet specially noted with coverage for 7 years or 70,000 miles is defective, the part will be repaired or replaced by Ford Motor Company. This is your long-term emission control system **DEFECTS WARRANTY**.

OWNER'S WARRANTY RESPONSIBILITIES:

- As the vehicle owner, you are responsible for the performance of the required maintenance listed in your owner's manual. Ford Motor Company recommends that you retain all receipts covering maintenance on your vehicle, but Ford Motor Company cannot deny warranty solely for the lack of receipts or for your failure to ensure the performance of all scheduled maintenance.

- You are responsible for presenting your vehicle to a Ford or Lincoln dealer as soon as a problem exists. The warranty repairs should be completed in a reasonable amount of time, not to exceed 30 days.

- As the vehicle owner, you should also be aware that Ford Motor Company may deny you warranty coverage if your vehicle or a part has failed due to abuse, neglect, improper maintenance or unapproved modifications.

If you have any questions regarding your warranty rights and responsibilities, you should contact Ford Customer Service at 1-800-392-3673 or the California Air Resource Board at 9528 Telstar Avenue, El Monte, CA 91731.

Appendices

ELECTROMAGNETIC COMPATIBILITY



WARNING: Do not place objects or mount equipment on or near the airbag cover, on the side of the front or rear seatbacks, or in areas that may come into contact with a deploying airbag. Failure to follow these instructions may increase the risk of personal injury in the event of a crash.



WARNING: Keep antenna and power cables at least 4 in (10 cm) from any electronic modules and airbags.

Note: We test and certify your vehicle to meet electromagnetic compatibility legislation. It is your responsibility to make sure that any equipment an authorized dealer installs on your vehicle complies with applicable local legislation and other requirements. Installation of some aftermarket electronic devices could degrade the performance of vehicle functions, which use radio frequency signals such as broadcast radio receiver, tire pressure monitoring system, push button start, **Bluetooth®** connectivity or satellite navigation.

Note: Any radio frequency transmitter equipment in your vehicle, such as, cellular telephones and amateur radio transmitters, must keep to the parameters in the following illustrations and table. We do not provide any other special provisions or conditions for installations or use.

Car

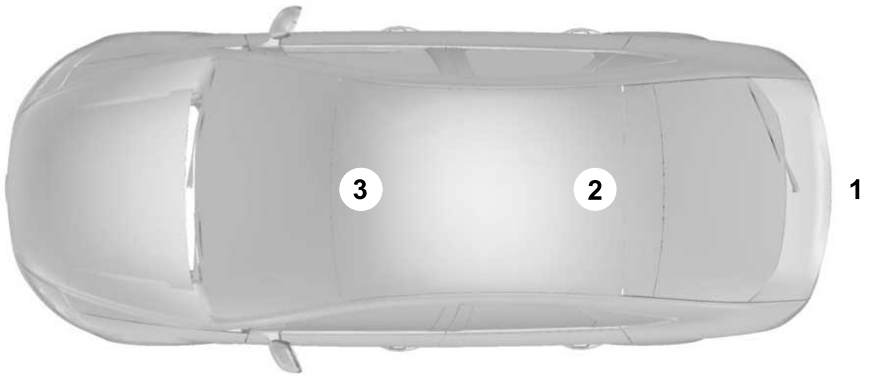

Appendices

Van



Truck

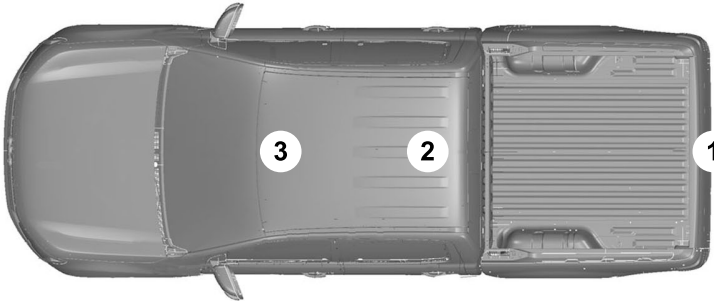

Appendices

Frequency Band MHz	Maximum Output Power Watt (Peak RMS)	Antenna Positions
1-30	50	1
50-54	50	2, 3
68-88	50	2, 3
142-176	50	2, 3
380-512	50	2, 3
806-870	10	2, 3

Index

1

12V Battery.....	412
12V Battery Precautions.....	412
Battery Management System Limitations.....	413
Changing the 12V Battery.....	413
How Does the Battery Management System Work.....	413
Recycling and Disposing of the 12V Battery.....	415
Resetting the Battery Sensor.....	414
What Is the Battery Management System.....	413
12V Battery – Troubleshooting.....	415
12V Battery – Information Messages.....	415
12V Battery – Warning Lamps.....	415

3

360 Degree Camera.....	251
360 Degree Camera Settings.....	253
360 Degree Camera Guide Lines.....	252
360 Degree Camera Precautions.....	251
360 Degree Camera Settings.....	253
Switching the 360 Degree Camera On and Off.....	253
Switching the 360 Degree Camera View.....	253

4

4WD	
See: Four-Wheel Drive.....	199

9

911 Assist.....	69
-----------------	----

A

A/C

See: Climate Control - Vehicles With: Automatic Temperature Control.....	137
See: Climate Control - Vehicles With: Manual Temperature Control.....	140
About This Publication.....	20
About Us.....	17

ABS

See: Brakes.....	215
Accessing Navigation.....	521
Accessing the Passive Key Backup Position - Vehicles With: Push Button Start.....	175
Accessing the Trip Computer.....	134
Accessories.....	527
Active Park Assist.....	255
Active Park Assist – Troubleshooting.....	259
Active Park Assist Precautions.....	255
Active Park Assist – Troubleshooting.....	259
Active Park Assist – Frequently Asked Questions.....	259
Active Park Assist – Information Messages.....	259
Adaptive Cruise Control.....	263
Adaptive Cruise Control – Troubleshooting.....	276
Intelligent Adaptive Cruise Control.....	274
Intelligent Adaptive Cruise Control – Troubleshooting.....	275
Lane Centering.....	270
Lane Centering – Troubleshooting.....	273
Adaptive Cruise Control Automatic Cancellation.....	266
Adaptive Cruise Control Indicators.....	270
Adaptive Cruise Control Limitations.....	264
Adaptive Cruise Control Precautions.....	263
Adaptive Cruise Control – Troubleshooting.....	276
Adaptive Cruise Control – Information Messages.....	276
Adaptive Front Lighting.....	104
How Does Adaptive Front Lighting Work.....	104
Switching Adaptive Front Lighting On and Off.....	105
Adjusting the Exterior Mirrors.....	112
Adjusting the Headlamps.....	416
Adjusting the Instrument Panel Lighting Brightness.....	107
Adjusting the Integrated Trailer Brake Controller Mode.....	341

Index

Adjusting the Map.....	521	Anti-Theft Alarm System.....	87
Changing the Format of the Map.....	521	Arming the Anti-Theft Alarm System.....	87
Zooming the Map In and Out.....	521	Disarming the Anti-Theft Alarm System.....	88
Adjusting the Seatbelt Height.....	55	How Does the Anti-Theft Alarm System Work.....	87
Adjusting the Seatbelts During Pregnancy.....	55	What Is the Anti-Theft Alarm System.....	87
Adjusting the Sound Settings.....	499	What Is the Perimeter Alarm.....	87
Adjusting the Speed Limit Tolerance.....	288	Appendices.....	611
Adjusting the Steering Wheel.....	90	Applying the Electric Parking Brake.....	219
Adjusting the Volume.....	498	Applying the Electric Parking Brake in an Emergency.....	219
After Driving Your Vehicle Off-Road.....	369	App Precautions.....	519
Aid Mode.....	292	App Requirements.....	519
How Does Aid Mode Work.....	292	Apps.....	519
What Is Aid Mode.....	292	Audio System.....	498
Airbag Precautions.....	62	Audio System – Troubleshooting.....	503
Airbags.....	60	Digital Radio.....	500
Front Passenger Sensing System.....	64	FM Radio.....	499
Air Conditioning		Satellite Radio.....	501
See: Climate Control - Vehicles With: Automatic Temperature Control.....	137	Audio System Precautions.....	498
See: Climate Control - Vehicles With: Manual Temperature Control.....	140	Audio System – Troubleshooting.....	503
Air Conditioning System Capacity and Specification - 2.3L EcoBoost™.....	485	Audio System – Information Messages.....	503
Air Conditioning System Capacity and Specification - 2.7L EcoBoost™.....	486	Auto-Dimming Exterior Mirror.....	113
Air Conditioning System Capacity and Specification - 3.0L EcoBoost™.....	487	What Is the Auto-Dimming Exterior Mirror.....	113
Alert and Aid Mode.....	292	Auto-Dimming Interior Mirror.....	111
How Does Alert and Aid Mode Work.....	293	Auto-Dimming Interior Mirror Limitations.....	111
What Is Alert and Aid Mode.....	292	What Is the Auto-Dimming Interior Mirror.....	111
Alert Mode.....	292	Auto Hold.....	227
How Does Alert Mode Work.....	292	Auto Hold Indicators.....	227
What Is Alert Mode.....	292	Autolamps.....	97
Alexa Built-In.....	512	Autolamp Settings.....	97
Alexa Built-In Requirements.....	512	What Are Autolamps.....	97
Alexa Built-In Settings.....	512	Autolock.....	80
Ambient Lighting.....	107	Autolock Requirements.....	80
Adjusting Ambient Lighting.....	107	What Is Autolock.....	80
Switching Ambient Lighting On and Off.....	107	Automatically Releasing the Electric Parking Brake.....	220
Anti-Lock Braking System.....	215	Automatic Crash Shutoff.....	380
Anti-Lock Braking System Indicators.....	215	Automatic Crash Shutoff Precautions.....	380
Anti-Lock Braking System Limitations.....	215	Re-Enabling Your Vehicle.....	380
		What Is Automatic Crash Shutoff.....	380

Index

Automatic Emergency Braking.....	315	Automatic Transmission.....	189
Switching Automatic Emergency Braking		Automatic Return to Park (P) - Vehicles	
On and Off.....	315	With: Electronic Shift.....	194
What Is Automatic Emergency		Automatic Transmission Positions.....	189
Braking.....	315	Brake Shift Interlock - Vehicles With:	
Automatic Engine Stop.....	174	Mechanical Shift.....	194
How Does Automatic Engine Stop		Manually Shifting Gears.....	191
Work.....	175	Manual Park Release - Vehicles With:	
Overriding Automatic Engine Stop.....	175	Electronic Shift.....	195
Switching Automatic Engine Stop On and		Temporary Neutral Mode - Vehicles With:	
Off.....	175	Electronic Shift.....	193
What Is Automatic Engine Stop.....	174	Automatic Transmission Fluid Capacity	
Automatic High Beam Control.....	101	and Specification.....	488
Automatic High Beam Control		Automatic Transmission Position	
Indicators.....	103	Indicators.....	191
Automatic High Beam Control		Automatic Transmission Positions.....	189
Limitations.....	102	Drive (D).....	190
Automatic High Beam Control		Manual (M).....	190
Precautions.....	102	Neutral (N).....	190
Automatic High Beam Control		Park (P).....	189
Requirements.....	102	Reverse (R).....	190
How Does Automatic High Beam Control		Automatic Transmission	
Work.....	101	Precautions.....	189
Overriding Automatic High Beam		Auto Mode.....	138
Control.....	103	Switching Auto Mode On and Off.....	138
Switching Automatic High Beam Control		Switching Dual Mode On and Off.....	139
On and Off.....	103	Autorelock.....	81
Automatic High Beam Control –		How Does Autorelock Work.....	81
Troubleshooting.....	103	Auto-Start-Stop.....	179
Automatic High Beam Control –		Auto-Start-Stop – Troubleshooting.....	180
Information Messages.....	103	Auto-Start-Stop Indicators.....	179
Automatic Locking Mode.....	54	Auto-Start-Stop Precautions.....	179
Disengaging Automatic Locking Mode.....	54	Auto-Start-Stop –	
Engaging Automatic Locking Mode.....	54	Troubleshooting.....	180
What Is Automatic Locking Mode.....	54	Auto-Start-Stop – Frequently Asked	
Automatic Return to Park (P) - Vehicles		Questions.....	181
With: Electronic Shift.....	194	Auto-Start-Stop – Information	
Automatic Return to Park (P)		Messages.....	180
Limitations.....	194	Autounlock.....	80
How Does Automatic Return to Park (P)		Autounlock Requirements.....	80
Work.....	194	Switching Autounlock On and Off.....	80
Automatic Transmission Audible		What Is Autounlock.....	80
Warnings - Vehicles With: Electronic		Autowipers.....	92
Shift.....	191	Adjusting the Sensitivity of the Rain	
Automatic Transmission Audible		Sensor.....	93
Warnings - Vehicles With: Mechanical		Autowipers Settings.....	93
Shift.....	191	What Are Autowipers.....	92
		Auxiliary Switches.....	529

Index

B

Basic Off-Road Driving	
Techniques.....	365
Battery Fuse Box.....	396
Accessing the Battery Fuse Box.....	396
Identifying the Fuses in the Battery Fuse Box.....	396
Locating the Battery Fuse Box.....	396
Beginning a Voice Interaction.....	510
Blind Spot Assist.....	294
Blind Spot Assist Indicators.....	295
Blind Spot Assist Limitations.....	294
How Does Blind Spot Assist Work.....	294
What Is Blind Spot Assist.....	294
Blind Spot Assist with Trailer	
Coverage.....	296
Blind Spot Assist with Trailer Coverage Indicators.....	297
Blind Spot Assist with Trailer Coverage Limitations.....	296
How Does Blind Spot Assist with Trailer Coverage Work.....	296
What Is Blind Spot Assist with Trailer Coverage.....	296
Blind Spot Information System.....	301
Blind Spot Information System – Troubleshooting.....	305
Blind Spot Information System With Trailer Coverage.....	303
Blind Spot Information System Indicators.....	305
Blind Spot Information System Limitations.....	301
Blind Spot Information System Precautions.....	301
Blind Spot Information System Requirements.....	301
Blind Spot Information System – Troubleshooting.....	305
Blind Spot Information System – Information Messages.....	306
Blind Spot Information System – Warning Lamps.....	305
Blind Spot Information System With Trailer Coverage.....	303
Blind Spot Information System With Trailer Coverage Limitations.....	303
How Does Blind Spot Information System With Trailer Coverage Work.....	303
Selecting a Trailer.....	305
Setting a Trailer Length.....	304
Switching Blind Spot Information System With Trailer Coverage On and Off.....	304
What Is Blind Spot Information System with Trailer Coverage.....	303
Bluetooth®.....	518
Body Control Module Fuse Box.....	396
Accessing the Body Control Module Fuse Box.....	397
Identifying the Fuses in the Body Control Module Fuse Box.....	397
Locating the Body Control Module Fuse Box.....	396
Bonnet Lock	
See: Opening and Closing the Hood.....	401
Booster Seats.....	49
Brake Fluid Specification.....	216
Brake Over Accelerator.....	215
Brake Precautions.....	215
Brakes.....	215
Anti-Lock Braking System.....	215
Brakes – Troubleshooting.....	217
Brake Shift Interlock - Vehicles With:	
Mechanical Shift.....	194
Brake Shift Interlock Precautions.....	194
Using Brake Shift Interlock.....	195
What Is Brake Shift Interlock.....	194
Brakes – Troubleshooting.....	217
Brakes – Frequently Asked Questions.....	218
Brakes – Information Messages.....	217
Brakes – Warning Lamps.....	217
Breaking-In.....	374

C

Calculating Payload.....	325
Calculating the Load Limit.....	325
Canceling the Set Speed.....	235
Canceling the Set Speed Limit.....	288
Capacities and Specifications.....	471
Catalytic Converter.....	188
Catalytic Converter – Troubleshooting.....	188
Catalytic Converter Precautions.....	188

Index

Catalytic Converter – Troubleshooting.....	188
Catalytic Converter – Warning Lamps.....	188
Center Console.....	169
Opening the Center Console.....	169
Center Display.....	507
Center Display Overview.....	507
Changing a Flat Tire – Excluding: Raptor.....	456
Changing a Flat Tire – Raptor.....	463
Changing a Road Wheel.....	456
Changing the Fuel Filter.....	411
Changing the Language.....	133
Changing the Measurement Unit.....	133
Changing the Remote Control Battery – Vehicles With: Flip Key.....	74
Changing the Remote Control Battery – Vehicles With: Push Button Start.....	73
Changing the Set Speed Limit.....	287
Changing the Temperature Unit.....	133
Changing the Tire Pressure Unit.....	133
Changing the Vehicle Wi-Fi Hotspot Name or Password.....	497
Charging a Device.....	162
Charging a Wireless Device.....	166
Checking the Brake Fluid.....	216
Checking the Seatbelts.....	58
Checking the Tire Pressures.....	447
Checking the Wiper Blades.....	93
Children and Airbags.....	64
Child Restraint Anchor Points.....	42
Locating the Child Restraint Lower Anchor Points.....	42
Locating the Child Restraint Top Tether Anchor Points.....	43
What Are the Child Restraint Anchor Points.....	42
Child Restraints.....	43
Child Restraint Position Information.....	43
Child Restraints Recommendation.....	44
Child Safety.....	41
Child Restraint Anchor Points.....	42
Child Restraints.....	43
Installing Child Restraints.....	44
Child Safety Locks.....	51
Child Safety Precautions.....	41
Cleaning the Exterior.....	426
Cleaning Camera Lenses and Sensors.....	427
Cleaning Chrome, Aluminium or Stainless Steel.....	426
Cleaning Headlamps and Rear Lamps.....	426
Cleaning Stripes or Graphics.....	427
Cleaning the Engine Compartment.....	427
Cleaning the Exterior Precautions.....	426
Cleaning the Underbody.....	427
Cleaning Wheels.....	426
Cleaning Windows and Wiper Blades.....	426
Cleaning the Interior.....	428
Cleaning Carpets and Floor Mats.....	429
Cleaning Displays and Screens.....	428
Cleaning Fabric.....	428
Cleaning Leather.....	428
Cleaning Plastic.....	428
Cleaning Seatbelts.....	429
Cleaning the Instrument Panel.....	428
Cleaning Vinyl.....	429
Climate Control.....	137
Auto Mode.....	138
Climate Control Hints.....	141
Connected Navigation.....	521
Connected Vehicle.....	493
Connected Vehicle – Troubleshooting.....	494
Connecting the Vehicle to a Mobile Network.....	493
Connected Vehicle Data.....	27
Connected Vehicle Limitations.....	493
Connected Vehicle Requirements.....	493
Connected Vehicle – Troubleshooting.....	494
Connected Vehicle – Frequently Asked Questions.....	494
Connecting a Bluetooth® Device.....	518
Connecting a Trailer.....	331
Connecting a Trailer – Troubleshooting.....	333
Connecting a Trailer Precautions.....	331
Connecting a Trailer – Troubleshooting.....	333
Connecting a Trailer – Information Messages.....	333

Index

Connecting the Vehicle to a Mobile Network.....	493
Connecting FordPass to the Modem.....	493
Enabling and Disabling the Modem.....	493
What Is the Modem.....	493
Connecting the Vehicle to a Wi-Fi Network.....	493
Connecting Your Phone.....	514
Contacting Us.....	18
Coolant.....	408
Adding Coolant.....	408
Changing the Coolant.....	410
Checking the Coolant Level.....	408
Coolant – Information Messages.....	411
Coolant – Warning Lamps.....	411
Managing the Coolant Temperature.....	410
Cooling System Capacity and Specification - 2.3L EcoBoost™.....	482
Cooling System Capacity and Specification - 2.7L EcoBoost™.....	482
Cooling System Capacity and Specification - 3.0L EcoBoost™.....	483
Crash and Breakdown Information.....	376
Automatic Crash Shutoff.....	380
Fail-Safe Cooling.....	383
Jump Starting the Vehicle.....	377
Post-Crash Alert System.....	379
Recovery Towing.....	380
Crash Sensors and Airbag Indicator.....	67
Creating a Vehicle Wi-Fi Hotspot.....	496
Cross Traffic Alert.....	307
Cross Traffic Alert – Troubleshooting.....	309
Cross Traffic Alert Indicators.....	308
Cross Traffic Alert Limitations.....	307
Cross Traffic Alert Precautions.....	307
Cross Traffic Alert – Troubleshooting.....	309
Cross Traffic Alert – Information Messages.....	309
Cruise Control.....	261
Cruise Control Indicators.....	262
Cup Holders.....	168
Locating the Cup Holders.....	168
Customer Information.....	538
Radio Frequency Certification Labels.....	541
Customizing the Instrument Cluster Display - Vehicles With: 12 Inch Screen.....	132
Customizing the Instrument Cluster Display - Vehicles With: 8 Inch Screen.....	132
D	
Data Privacy.....	25
Department of Transportation Uniform Tire Quality Grades.....	433
Digital Radio.....	500
Digital Radio Indicators.....	501
Digital Radio Limitations.....	500
How Does Digital Radio Work.....	500
Switching Digital Radio Reception On and Off.....	500
What Is Digital Radio.....	500
Dinghy Tow See: Recreationally Towing Your Vehicle.....	385
Directing the Flow of Air.....	138
Disposing of Airbags.....	68
Distance Alert.....	314
Adjusting the Sensitivity of Distance Alert.....	315
What Is Distance Alert.....	314
Distance Indication.....	313
Distance Indication Indicator.....	314
Switching Distance Indication On and Off.....	314
What Is Distance Indication.....	313
Door Lock Indicators.....	81
Doors and Locks Audible Warnings.....	81
Doors and Locks.....	79
Autolock.....	80
Autorelock.....	81
Autounlock.....	80
Doors and Locks – Troubleshooting.....	81
Mislock.....	80
Operating the Doors From Inside Your Vehicle.....	79
Operating the Doors From Outside Your Vehicle.....	79
Doors and Locks – Troubleshooting.....	81
Doors and Locks – Frequently Asked Questions.....	82

Index

Doors and Locks – Information	
Messages.....	81
Doors and Locks – Warning Lamps.....	81
Drive Belt Routing Overview - 2.3L	
EcoBoost™.....	412
Drive Belt Routing Overview - 2.7L	
EcoBoost™/3.0L EcoBoost™.....	412
Drive Mode Control.....	278
Drive Modes.....	279
Drive Modes.....	279
Baja.....	284
Eco.....	279
Mud/Ruts.....	279
Normal.....	279
Off-Road.....	285
Rock Crawl.....	285
Sand.....	280
Slippery.....	280
Sport.....	286
Tow/Haul.....	280
Trail.....	281
Driver Alert.....	321
Driver Alert – Troubleshooting.....	322
Driver Alert Indicators.....	322
Driver Alert Limitations.....	321
Driver Alert Precautions.....	321
Driver Alert – Troubleshooting.....	322
Driver Alert – Information Messages.....	322
Driving Economically.....	374
Driving Hints.....	374
Driving in Cold Weather.....	374
Driving Through Water	
Limitations.....	366
Driving Your Vehicle at High	
Speeds.....	366
Drowsiness Monitor	
See: Driver Alert.....	321
E	
Electric Parking Brake Audible	
Warning.....	220
Electric Parking Brake.....	219
Electric Parking Brake –	
Troubleshooting.....	220
Electric Parking Brake –	
Troubleshooting.....	220
Messages.....	221
Electric Parking Brake – Warning	
Lamps.....	220
Electric Power Steering.....	240
Electric Power Steering Precautions.....	240
How Does Electric Power Steering	
Work.....	240
Electromagnetic Compatibility.....	611
Electronic Locking Differential.....	208
Electronic Locking Differential –	
Troubleshooting.....	212
Electronic Locking Differential Indicators	
– Excluding: Raptor.....	211
Electronic Locking Differential Indicators	
– Raptor.....	211
Electronic Locking Differential –	
Troubleshooting.....	212
Electronic Locking Differential –	
Information Messages.....	212
Emergency Call Limitations.....	70
Emergency Call Requirements.....	69
Emergency Call System Data.....	28
Emergency Towing.....	385
Emission Law.....	608
Enabling Apps on an Android	
Device.....	519
Enabling Apps on an iOS Device.....	519
Enabling Remote Start.....	135
End User License Agreement.....	583
Engine Air Filter.....	407
Changing the Engine Air Filter.....	407
Engine Block Heater.....	172
Engine Block Heater Precautions.....	172
How Does the Engine Block Heater	
Work.....	173
Using the Engine Block Heater.....	173
Engine Coolant Temperature	
Gauge.....	118
Engine Oil Capacity and Specification -	
2.3L EcoBoost™.....	477
Engine Oil Capacity and Specification -	
2.7L EcoBoost™.....	478

Index

Engine Oil Capacity and Specification - 3.0L EcoBoost™.....	480
Engine Oil.....	406
Adding Engine Oil.....	406
Checking the Engine Oil Level.....	406
Engine Oil Capacity and Specification.....	407
Engine Oil Dipstick Overview.....	406
Engine Oil – Information Messages.....	407
Intelligent Oil Life Monitor.....	407
Resetting the Intelligent Oil Life Monitor.....	407
Engine Oil Pressure Gauge - Vehicles With: 12 Inch Screen.....	118
Engine Oil Pressure Gauge - Vehicles With: 8 Inch Screen.....	118
Engine Specifications - 2.3L EcoBoost™.....	471
Engine Specifications - 2.7L EcoBoost™.....	472
Engine Specifications - 3.0L EcoBoost™.....	473
Entering a Parallel Parking Space - Vehicles With: Fully Active Park Assist.....	256
Entering a Parallel Parking Space - Vehicles With: Semi Active Park Assist.....	257
Entering a Perpendicular Parking Space - Vehicles With: Fully Active Park Assist.....	257
Entering a Perpendicular Parking Space - Vehicles With: Semi Active Park Assist.....	258
Environment.....	29
Evasive Steering Assist.....	315
Evasive Steering Assist Limitations.....	315
Switching Evasive Steering Assist On and Off.....	316
What Is Evasive Steering Assist.....	315
Event Data.....	26
Exiting a Parking Space - Vehicles With: Fully Active Park Assist.....	258
Exiting a Parking Space - Vehicles With: Semi Active Park Assist.....	259
Export Unique Options.....	609
Extending the Remote Start Duration.....	136
Exterior Bulbs.....	417
Changing a Front Fog Lamp Bulb.....	424
Changing a Front Turn Signal Lamp Bulb.....	422
Changing a Headlamp Bulb.....	419
Changing a Rear Lamp Bulb.....	424
Exterior Bulb Specification Chart.....	417
Removing a Rear Lamp Assembly.....	419
Exterior Lamps.....	98
Exterior Lamp Indicators.....	100
Exterior Lamps On Audible Warning.....	100
Switching the Cargo Lamps On.....	99
Switching the Daytime Running Lamps On and Off.....	98
Switching Welcome Lighting On and Off.....	100
Using the Front Fog Lamps.....	99
Using the Turn Signal Lamps.....	98
Exterior Lighting Control.....	96
Exterior Lighting.....	96
Adaptive Front Lighting.....	104
Autolamps.....	97
Automatic High Beam Control.....	101
Automatic High Beam Control – Troubleshooting.....	103
Exterior Lamps.....	98
Exterior Zone Lighting.....	100
Headlamps.....	96
Headlamps – Troubleshooting.....	97
Exterior Mirrors.....	112
Auto-Dimming Exterior Mirror.....	113
Exterior Zone Lighting.....	100
Using the Exterior Zone Lighting.....	100
What Is Exterior Zone Lighting.....	100

F

Fail-Safe Cooling.....	383
Driving When Fail-Safe Mode Is Activated.....	383
Fail-Safe Cooling Indicators.....	384
How Does Fail-Safe Cooling Work.....	383
What Is Fail-Safe Cooling.....	383
Fastening and Unfastening the Seatbelts.....	53
Federal Highway Administration Regulation.....	582

Index

Flat Tire	
See: Changing a Flat Tire - Excluding:	
Raptor.....	456
See: Changing a Flat Tire - Raptor.....	463
Flat Tow	
See: Recreationally Towing Your	
Vehicle.....	385
Floor Mats.....	375
FM Radio.....	499
FM Radio Limitations.....	499
Selecting an FM Radio Station.....	499
Folding the Exterior Mirrors - Vehicles	
With: Manual Folding Mirrors.....	112
Folding the Exterior Mirrors - Vehicles	
With: Power Folding Mirrors.....	112
Ford Performance.....	17
Ford Protect.....	532
Four-Wheel Drive.....	199
Four-Wheel Drive Modes.....	204
Four-Wheel Drive – Troubleshooting.....	205
Four-Wheel Drive Indicators.....	205
Four-Wheel Drive Limitations -	
Excluding: Raptor.....	200
Four-Wheel Drive Limitations -	
Raptor.....	202
Four-Wheel Drive Modes.....	204
Four-Wheel Drive Auto.....	205
Four-Wheel Drive High.....	205
Four-Wheel Drive Low.....	205
Two-Wheel Drive High.....	204
Four-Wheel Drive Precautions.....	199
Four-Wheel Drive –	
Troubleshooting.....	205
Four-Wheel Drive – Information	
Messages.....	206
Four-Wheel Drive – Warning Lamps.....	205
Four Wheels Down Tow	
See: Recreationally Towing Your	
Vehicle.....	385
Front Axle Fluid Capacity and	
Specification.....	490
Front Exterior - Excluding: Raptor.....	36
Front Exterior - Raptor.....	37
Front Parking Aid.....	244
Front Parking Aid Audible Warnings.....	245
Front Parking Aid Limitations.....	245
Locating the Front Parking Aid	
Sensors.....	245
What is the Front Parking Aid.....	244
Front Passenger Sensing System.....	64
Front Passenger Sensing System	
Indicators.....	66
Front Passenger Sensing System	
Precautions.....	66
How Does the Front Passenger Sensing	
System Work.....	64
What Is the Front Passenger Sensing	
System.....	64
Front Seat Precautions.....	144
Front Seats.....	144
Heated Seats.....	149
Manual Seats.....	145
Power Seats.....	147
Fuel and Refueling.....	182
Fuel and Refueling –	
Troubleshooting.....	187
Fuel Quality.....	182
Refueling.....	185
Running Out of Fuel.....	183
Fuel and Refueling Precautions.....	182
Fuel and Refueling –	
Troubleshooting.....	187
Fuel and Refueling – Information	
Messages.....	187
Fuel and Refueling – Warning Lamps.....	187
Fuel Gauge.....	118
Fuel Gauge Limitations.....	118
Locating the Fuel Filler Door.....	118
What Is Distance to Empty.....	118
What Is the Fuel Gauge.....	118
What Is the Low Fuel Reminder.....	118
Fuel Quality.....	182
Selecting the Correct Fuel.....	182
Fuel Tank Capacity.....	186
Fuse Precautions.....	386
Fuses.....	386
Battery Fuse Box.....	396
Body Control Module Fuse Box.....	396
Fuses – Troubleshooting.....	400
Under Hood Fuse Box.....	386
Fuses – Troubleshooting.....	400
Fuses – Frequently Asked	
Questions.....	400

Index

G	
Garage Door Opener Additional Assistance.....	160
Garage Door Opener.....	157
Garage Door Opener Introduction.....	157
Garage Door Opener Precautions and Frequencies.....	157
General Maintenance Information.....	534
Glasses Holder.....	169
Locating the Glasses Holder.....	169
Global Opening and Closing.....	108
Switching Global Closing On and Off.....	109
Switching Global Opening On and Off.....	109
Using Global Closing.....	109
Using Global Opening.....	109
What Is Global Opening and Closing.....	108
Glossary of Tire Terminology.....	439
Glove Compartment.....	168
Locking the Glove Compartment.....	168
Opening the Glove Compartment.....	168
H	
Headlamp Adjusting	
See: Adjusting the Headlamps.....	416
Headlamps.....	96
Adjusting the Level of the Headlamps.....	96
Headlamp Indicators.....	96
Switching Headlamp Exit Delay On and Off.....	96
Using the High Beam Headlamps.....	96
Headlamps – Troubleshooting.....	97
Headlamps – Frequently Asked Questions.....	97
Heated Seats.....	149
Heated Seat Precautions.....	149
Switching the Heated Seats On and Off.....	150
Heating	
See: Climate Control - Vehicles With: Automatic Temperature Control.....	137
See: Climate Control - Vehicles With: Manual Temperature Control.....	140
Hill Start Assist.....	226
Hill Start Assist – Troubleshooting.....	226
Hill Start Assist Precautions.....	226
Hill Start Assist – Troubleshooting.....	226
Hill Start Assist – Information Messages.....	226
Hood Lock	
See: Opening and Closing the Hood.....	401
Horn.....	90
How Does 911 Assist Work.....	69
How Does Active Park Assist Work - Vehicles With: Fully Active Park Assist.....	255
How Does Active Park Assist Work - Vehicles With: Semi Active Park Assist.....	255
How Does Adaptive Cruise Control With Stop and Go Work.....	263
How Does Adaptive Cruise Control Work.....	263
How Does Auto Hold Work.....	227
How Does Blind Spot Information System Work.....	301
How Does Cross Traffic Alert Work.....	307
How Does Drive Mode Control Work.....	278
How Does Driver Alert Work.....	321
How Does Four-Wheel Drive Work - 4x4 with Part Time Engagement.....	199
How Does Four-Wheel Drive Work - Advanced 4x4 with 4A Mode.....	199
How Does Hill Start Assist Work.....	226
How Does Pre-Collision Assist Work.....	310
How Does Reverse Brake Assist Work.....	222
How Does Speed Sign Recognition Work.....	318
How Does Stability Control Work.....	231
How Does the 360 Degree Camera Work.....	251
How Does the Intelligent Speed Limiter Work.....	287
How Does the Lane Keeping System Work.....	290
How Does the Personal Safety System Work.....	59
How Does the Rear Occupant Alert System Work.....	154

Index

How Does the Safety Canopy™ Work.....	62
How Does Traction Control Work.....	229
How Does Trailer Backup Assistance Work.....	345
How Does Trailer Reverse Guidance Work.....	356
How Does Trailer Sway Control Work.....	344
How Do the Front Airbags Work.....	60
How Do the Knee Airbags Work.....	61
How Do the Side Airbags Work.....	60
I	
Icon Glossary See: Symbols Glossary.....	22
Icons See: Symbols Glossary.....	22
Identifying Fuse Types.....	400
Identifying the Auxiliary Switch Wiring.....	530
Identifying the Climate Control Unit.....	137
Ignition Switch.....	170
Inflating the Tires.....	447
Information on the Tire Sidewall.....	434
Inspecting the Tire for Damage.....	448
Inspecting the Tire for Wear.....	448
Inspecting the Wheel Valve Stems.....	450
Installing Child Restraints.....	44
Combining the Seatbelt and Lower Anchors for Attaching Child Restraints.....	48
Installing a Child Restraint in a Center Seat.....	47
Using Lower Anchors and Tethers for Children.....	46
Using Seatbelts.....	44
Using Tether Straps.....	48
Instrument Cluster Display.....	125
Instrument Cluster Display Main Menu - Raptor, Vehicles With: 12 Inch Screen.....	128
Instrument Cluster Display Main Menu - Vehicles With: 12 Inch Screen, Excluding: Raptor.....	126
Instrument Cluster Display Main Menu - Vehicles With: 8 Inch Screen.....	130
Instrument Cluster Indicators - Excluding: Raptor.....	121
Instrument Cluster Indicators - Raptor.....	122
Instrument Cluster.....	116
Fuel Gauge.....	118
Instrument Cluster Overview - Vehicles With: 12 Inch Screen.....	116
Instrument Cluster Overview - Vehicles With: 8 Inch Screen.....	116
Instrument Cluster Warning Lamps.....	119
Instrument Panel - Excluding: Raptor.....	32
Instrument Panel - Raptor.....	33
Integrated Trailer Brake Controller.....	340
Integrated Trailer Brake Controller - Troubleshooting.....	342
Integrated Trailer Brake Controller Precautions.....	340
Integrated Trailer Brake Controller - Troubleshooting.....	342
Integrated Trailer Brake Controller - Frequently Asked Questions.....	343
Integrated Trailer Brake Controller - Information Messages.....	342
Intelligent Adaptive Cruise Control.....	274
Adjusting the Set Speed Tolerance.....	275
How Does Intelligent Adaptive Cruise Control Work.....	274
Intelligent Adaptive Cruise Control Alerts.....	275
Intelligent Adaptive Cruise Control Indicators.....	275
Intelligent Adaptive Cruise Control Limitations.....	274
Intelligent Adaptive Cruise Control Precautions.....	274
Switching Intelligent Mode On and Off.....	275
Intelligent Adaptive Cruise Control - Troubleshooting.....	275
Intelligent Adaptive Cruise Control - Information Messages.....	275
Intelligent Speed Limiter Audible Warnings.....	288

Index

Intelligent Speed Limiter Indicators.....	288
Intelligent Speed Limiter.....	287
Intelligent Speed Limiter – Troubleshooting.....	289
Intelligent Speed Limiter Precautions.....	287
Intelligent Speed Limiter – Troubleshooting.....	289
Intelligent Speed Limiter – Frequently Asked Questions.....	289
Intentionally Exceeding the Set Speed Limit.....	288
Interior Air Quality.....	143
Interior Bulbs.....	425
Interior Bulb Specification Chart.....	425
Interior Lamp Function.....	106
Switching the Interior Lamp Function On and Off.....	106
What Is the Interior Lamp Function.....	106
Interior Lighting.....	106
Ambient Lighting.....	107
Interior Lamp Function.....	106
Interior Lighting – Troubleshooting.....	107
Interior Lighting – Troubleshooting.....	107
Interior Lighting – Frequently Asked Questions.....	107
Interior Mirror.....	111
Auto-Dimming Interior Mirror.....	111
Interior Mirror Precautions.....	111
Introduction.....	20

J

Jump Starting the Vehicle.....	377
Jump Starting Precautions.....	377
Jump Starting the Vehicle.....	378
Preparing the Vehicle.....	378

K

Keyless Entry.....	83
Keyless Entry – Troubleshooting.....	83
Keyless Entry Limitations.....	83
Keyless Entry Settings.....	83
Keyless Entry – Troubleshooting.....	83
Keyless Entry – Frequently Asked Questions.....	83

Keys and Remote Controls Audible Warnings - Vehicles With: Flip Key.....	78
Keys and Remote Controls Audible Warnings - Vehicles With: Push Button Start.....	77
Keys and Remote Controls.....	71
Keys and Remote Controls – Troubleshooting.....	78
Keys and Remote Controls – Troubleshooting.....	78
Keys and Remote Controls – Information Messages.....	78

L

Lane Centering.....	270
How Does Lane Centering Work.....	270
Lane Centering Alerts.....	272
Lane Centering Automatic Cancellation.....	272
Lane Centering Indicators.....	273
Lane Centering Limitations.....	271
Lane Centering Manual Cancellation.....	273
Lane Centering Precautions.....	271
Lane Centering Requirements.....	271
Switching Lane Centering On and Off.....	272
Lane Centering – Troubleshooting.....	273
Lane Centering – Information Messages.....	273
Lane Keeping System Indicators.....	293
Lane Keeping System.....	290
Aid Mode.....	292
Alert and Aid Mode.....	292
Alert Mode.....	292
Blind Spot Assist.....	294
Blind Spot Assist with Trailer Coverage.....	296
Lane Keeping System – Troubleshooting.....	298
Lane Keeping System Limitations.....	290
Lane Keeping System Precautions.....	290
Lane Keeping System Settings.....	291
Lane Keeping System – Troubleshooting.....	298
Lane Keeping System – Frequently Asked Questions.....	299

Index

Lane Keeping System – Information	
Messages.....	298
Launching or Retrieving a Boat or	
Personal Watercraft.....	336
Live Traffic.....	521
Switching Live Traffic On and Off.....	521
What Is Live Traffic.....	521
Load Carrying.....	323
Load Carrying Precautions.....	323
Loading Your Trailer.....	335
Locating the 360 Degree Cameras.....	251
Locating the Auxiliary Switches.....	529
Locating the Auxiliary Switch	
Wiring.....	529
Locating the Blind Spot Information	
System Sensors.....	302
Locating the Brake Fluid Reservoir.....	215
Locating the Cross Traffic Alert	
Sensors.....	308
Locating the Fuel Filler Funnel.....	183
Locating the Memory Function	
Buttons.....	156
Locating the Power Outlets.....	163
Locating the Pre-Collision Assist	
Sensors.....	312
Locating the Rear View Camera.....	248
Locating the Safety Compliance	
Certification Labels.....	324
Locating the Tire label.....	433
Locating the USB Ports.....	161
Locating the Wireless Accessory	
Charger.....	166
Locating Your Vehicle.....	72
Locking and Unlocking the Tailgate.....	85
Locking the Rear Window Controls.....	110
Locking the Steering Wheel - Vehicles	
With: Push Button Start.....	90
Locking the Steering Wheel - Vehicles	
Without: Push Button Start.....	90
M	
Maintenance.....	401
12V Battery.....	412
12V Battery – Troubleshooting.....	415
Coolant.....	408
Engine Air Filter.....	407
Engine Oil.....	406
Exterior Bulbs.....	417
Interior Bulbs.....	425
Maintenance Precautions.....	401
Making and Receiving a Phone Call.....	515
Manually Dimming the Interior	
Mirror.....	111
Manually Releasing the Electric Parking	
Brake.....	219
Manually Shifting Gears.....	191
Shifting Using the Buttons on the Selector	
Lever.....	192
Shifting Using the Paddle Shifters.....	191
Manual Park Release - Vehicles With:	
Electronic Shift.....	195
Manual Park Release Precautions.....	196
Using Manual Park Release.....	196
What Is Manual Park Release.....	195
Manual Seats.....	145
Adjusting the Head Restraint.....	145
Adjusting the Lumbar Support.....	147
Adjusting the Seat Backrest.....	146
Adjusting the Seat Height.....	147
Folding the Seat Backrest.....	152
Folding the Seats.....	152
Head Restraint Components.....	145
Installing the Head Restraint.....	146
Moving the Seat Backward and	
Forward.....	146
Removing the Head Restraint.....	146
Unfolding the Seat Backrest.....	152
Unfolding the Seats.....	153
Memory Function.....	156
Memory Function Precautions.....	156
Mislock.....	80
Mislock Limitations.....	80
Switching Mislock On and Off.....	80
What Is Mislock.....	80
Mobile Communications	
Equipment.....	582
Mobile Device Data.....	28
Moonroof Bounce-Back.....	115
Overriding Moonroof Bounce-Back.....	115
What Is Moonroof Bounce-Back.....	115
Moonroof.....	114
Moonroof Bounce-Back.....	115
Motorcraft Parts - 2.3L	
EcoBoost™.....	474

Index

Motorcraft Parts - 2.7L EcoBoost™	475
Motorcraft Parts - 3.0L EcoBoost™	476

N

Navigation Map Updates	521
Navigation	521
Adjusting the Map	521
Live Traffic	521
Route Guidance	522
Setting a Destination	521
Waypoints	522
Neutral Towing	
See: Recreationally Towing Your Vehicle	385
Neutral Tow	
See: Recreationally Towing Your Vehicle	385

O

Off-Road Driving Aids	368
Off-Road Driving	365
Off-Road Screen	370
Off-Road Screen	370
How Does The Off-Road Screen Work	370
Switching The Off-Road Screen On and Off	370
Using the Off-Road Screen	370
What Is The Off-Road Screen	370
Opening and Closing the Flip Key	72
Opening and Closing the Hood	401
Opening and Closing the Moonroof	114
Opening and Closing the Sliding Windows	110
Opening and Closing the Sunshade	114
Opening and Closing the Windows	108
Opening the Tailgate	85
Opening the Tailgate From Outside Your Vehicle	85
Opening the Doors From Inside Your Vehicle	79
Opening the Doors From Inside Your Vehicle	79

Unlocking and Locking the Doors Using the Central Locking	79
Unlocking and Locking the Doors Using the Key Blade	79
Unlocking and Locking the Doors Using the Remote Control	79
Ordering a Canadian French Owner's Manual	539
OTA	
See: Software Update Settings	524
See: Vehicle Software Updates	524
Overriding Reverse Brake Assist	223
Overriding the Set Speed	270
Over the air	
See: Software Update Settings	524
Over-the-air	
See: Software Update Settings	524
See: Vehicle Software Updates	524
See: Vehicle Software Updates	524

P

Parking Aid Indicators	247
Parking Aid Precautions	243
Parking Aids	243
Front Parking Aid	244
Parking Aids – Troubleshooting	247
Rear Parking Aid	244
Side Parking Aid	245
Parking Aids – Troubleshooting	247
Parking Aids – Information Messages	247
Passive Anti-Theft System	87
How Does the Passive Anti-Theft System Work	87
What Is the Passive Anti-Theft System	87
Perchlorate	581
Performing a System Reset	526
Personalized Settings	133
Personal Safety System	
Components	59
Personal Safety System™	59
Phone Menu	514
Phone	514
Phone Precautions	514

Index

Pickup Bed Access Caps.....	330	Power-Up	
Locating the Pickup Bed Access		See: Software Update Settings.....	524
Caps.....	330	See: Vehicle Software Updates.....	524
What are Pickup Bed Access Caps.....	330	Pre-Collision Assist Limitations.....	311
Pickup Bed Anchor Points.....	328	Pre-Collision Assist Precautions.....	310
Locating the Pickup Bed Anchor		Pre-Collision Assist.....	310
Points.....	328	Automatic Emergency Braking.....	315
Pickup Bed Anchor Point Load		Distance Alert.....	314
Capacities.....	329	Distance Indication.....	313
Pickup Bed Anchor Point		Evasive Steering Assist.....	315
Precautions.....	328	Pre-Collision Assist –	
Pickup Bed.....	328	Troubleshooting.....	316
Pickup Bed Access Caps.....	330	Pre-Collision Assist –	
Pickup Bed Anchor Points.....	328	Troubleshooting.....	316
Pickup Bed Slots.....	330	Pre-Collision Assist – Frequently Asked	
Pickup Bed Precautions.....	328	Questions.....	317
Pickup Bed Slots.....	330	Pre-Collision Assist – Information	
Locating the Pickup Bed Slots.....	330	Messages.....	316
Playing Media Using Bluetooth®.....	518	Pre-Collision Assist – Warning	
Playing Media Using the USB Port.....	161	Lamps.....	316
Playing or Pausing the Audio		Preparing Your Vehicle for Storage.....	431
Source.....	498	Programming the Garage Door	
Post-Collision Braking.....	379	Opener.....	158
Post-Crash Alert System.....	379	Programming the Remote Control -	
How Does the Post-Crash Alert System		Vehicles With: Flip Key.....	77
Work.....	379	Programming the Remote Control -	
Post-Crash Alert System Limitations.....	379	Vehicles With: Push Button Start.....	76
Switching the Post-Crash Alert System		Properly Adjusting the Driver and Front	
Off.....	379	Passenger Seats.....	63
What Is the Post-Crash Alert		Protecting the Environment.....	29
System.....	379	Puncture	
Power Outlet Indicators.....	163	See: Changing a Flat Tire - Excluding:	
Power Outlet Limitations.....	163	Raptor.....	456
Power Outlet.....	163	See: Changing a Flat Tire - Raptor.....	463
Power Outlet Precautions.....	163	Push Button Ignition Switch.....	171
Power Seats.....	147		
Adjusting the Head Restraint.....	147	R	
Adjusting the Lumbar Support.....	149	Radio Frequency Certification	
Adjusting the Seat Backrest.....	148	Labels.....	541
Adjusting the Seat Cushion.....	148	Audio Unit.....	541
Adjusting the Seat Height.....	149	Blind Spot Information System	
Head Restraint Components.....	147	Sensors.....	542
Installing the Head Restraint.....	148	Body Control Module.....	548
Moving the Seat Backward and		Cruise Control Module.....	550
Forward.....	148	Keys and Remote Controls.....	555
Removing the Head Restraint.....	148	Passive Anti-Theft System.....	558
		Radio Transceiver Module.....	562

Index

SYNC.....	565	Releasing the Electric Parking Brake if the Vehicle Battery Has Run Out of Charge.....	220
Telematics Control Unit.....	570	Remote Control Limitations.....	71
Tire Pressure Monitoring System Sensors.....	572	Remotely Starting and Stopping the Vehicle.....	135
Wireless Accessory Charging Module.....	574	Remote Start Limitations.....	135
Rear Axle Fluid Capacity and Specification.....	490	Remote Start Precautions.....	135
Rear Exterior - Excluding: Raptor.....	38	Remote Start Remote Control Indicators.....	136
Rear Exterior - Raptor.....	39	Remote Start.....	135
Rear Occupant Alert System Audible Warnings.....	155	Remote Start Settings.....	136
Rear Occupant Alert System Indicators.....	155	Removing the Key Blade.....	72
Rear Occupant Alert System Limitations.....	154	Removing Your Vehicle From Storage.....	432
Rear Occupant Alert System Precautions.....	154	Repairing Minor Paint Damage.....	429
Rear Occupant Alert System.....	154	Replacement Parts Recommendation.....	581
Rear Parking Aid.....	244	Replacing a Lost Key or Remote Control.....	75
Locating the Rear Parking Aid Sensors.....	244	Replacing the Cabin Air Filter.....	143
Rear Parking Aid Audible Warnings.....	244	Replacing the Front Wiper Blades.....	93
Rear Parking Aid Limitations.....	244	Reporting Safety Defects in Canada.....	540
What is the Rear Parking Aid.....	244	Reporting Safety Defects in the United States.....	540
Rear Seats.....	151	Resetting the Trip Computer.....	134
Manual Seats.....	151	Restarting the Engine.....	179
Rear View Camera Guide Lines.....	249	Resuming the Set Speed Limit.....	288
Rear View Camera Precautions.....	248	Resuming the Set Speed.....	262
Rear View Camera.....	248	Reverse Brake Assist Indicators.....	223
Rear View Camera Settings.....	249	Reverse Brake Assist Precautions.....	222
Rear View Camera Settings.....	249	Reverse Brake Assist.....	222
Switching Rear View Camera Delay On and Off.....	250	Reverse Brake Assist – Troubleshooting.....	224
Switching the Rear View Camera View.....	250	Reverse Brake Assist – Troubleshooting.....	224
Zooming the Rear View Camera In and Out.....	249	Reverse Brake Assist – Frequently Asked Questions.....	225
Rebooting the Center Display.....	509	Reverse Brake Assist – Information Messages.....	224
Recalling a Preset Position.....	156	Roadside Assistance.....	376
Recovery Towing.....	380	Rollover Warning.....	538
Accessing the Front Towing Point.....	380	Route Guidance.....	522
Accessing the Rear Towing Point.....	381	Adjusting the Guidance Prompt Volume.....	522
Recreationally Towing Your Vehicle.....	385	Canceling Route Guidance.....	523
Refueling.....	185	Repeating an Instruction.....	523
Refueling System Overview.....	185		
Refueling Your Vehicle.....	185		

Index

Running-In	
See: Breaking-In.....	374
Running Out of Fuel.....	183
Adding Fuel From a Portable Fuel Container.....	184
Filling a Portable Fuel Container.....	183
S	
Satellite Radio.....	501
Locating the Satellite Radio Identification Number.....	501
Satellite Radio Limitations.....	501
Satellite Radio Settings.....	502
Selecting a Channel.....	502
What Is Satellite Radio.....	501
Saving a Preset Position.....	156
Scheduled Maintenance.....	534
Seatbelt Extensions.....	58
Seatbelt Precautions.....	52
Seatbelt Reminder.....	56
How Does the Seatbelt Reminder Work.....	56
Seatbelt Reminder Audible Warnings.....	57
Seatbelt Reminder Indicators.....	56
Switching the Seatbelt Reminder On and Off.....	57
Seatbelts.....	52
Automatic Locking Mode.....	54
Seatbelt Reminder.....	56
Sensitive Locking Mode.....	54
Security.....	87
Anti-Theft Alarm System.....	87
Passive Anti-Theft System.....	87
Security – Troubleshooting.....	88
Security – Troubleshooting.....	88
Security – Frequently Asked Questions.....	89
Security – Information Messages.....	88
Selecting a Drive Mode.....	278
Selecting a Four-Wheel Drive Mode - 4x4 with Part Time Engagement.....	203
Selecting a Four-Wheel Drive Mode - Advanced 4x4 with 4A Mode.....	204
Selecting the Audio Source.....	498
Sending and Receiving a Text Message.....	516
Sensitive Locking Mode.....	54
How Does Sensitive Locking Mode Work.....	54
What Is Sensitive Locking Mode.....	54
Service Data.....	26
Setting a Destination.....	521
Setting a Destination Using a Point of Interest.....	522
Setting a Destination Using a Predictive Destination.....	522
Setting a Destination Using a Recent Destination.....	522
Setting a Destination Using a Saved Destination.....	522
Setting a Destination Using the Map Screen.....	522
Setting a Destination Using the Text Entry Screen.....	521
Setting a Memory Preset.....	499
Settings Data.....	27
Settings.....	508
Setting the Adaptive Cruise Control Gap.....	267
Setting the Adaptive Cruise Control Speed.....	266
Setting the Blower Motor Speed.....	138
Setting the Clock and Date.....	499
Setting the Cruise Control Speed.....	261
Setting the Speed Limit.....	287
Setting the Speed Sign Recognition Speed Tolerance.....	319
Setting the Speed Sign Recognition Speed Warning.....	319
Setting the Temperature.....	138
Setting the Trail Control Speed.....	235
Setting the Wake Word.....	510
Setting Up the Trailer Backup Assistance for a Conventional Trailer.....	345
Applying the Trailer Reversing Aid Sticker.....	347
Calibrating the System.....	347
Configuring the Trailer.....	345
Setting Up Trailer Reverse Guidance for a Conventional Trailer.....	356
Applying the Trailer Reverse Aid Sticker.....	357
Calibrating the System.....	358
Configuring the Trailer.....	356

Index

Shifting Your Vehicle Into Gear - Vehicles With: Electronic Shift.....	190
Shifting Your Vehicle Into Gear - Vehicles With: Mechanical Shift.....	190
Side Parking Aid.....	245
Locating the Side Parking Aid Sensors.....	246
Side Parking Aid Audible Warnings.....	246
Side Parking Aid Limitations.....	245
What is the Side Parking Aid.....	245
Signing In to Your Account.....	512
Sitting in the Correct Position.....	144
Software Update Indicators.....	525
Software Update Settings.....	524
Software Update	
See: Software Update Settings.....	524
See: Vehicle Software Updates.....	524
Sounding the Panic Alarm.....	72
Speed Control	
See: Cruise Control.....	261
Speedometer.....	117
Speed Sign Recognition Indicators.....	318
Speed Sign Recognition Limitations.....	318
Speed Sign Recognition Precautions.....	318
Speed Sign Recognition.....	318
Speed Sign Recognition – Troubleshooting.....	319
Speed Sign Recognition – Troubleshooting.....	319
Speed Sign Recognition – Frequently Asked Questions.....	320
Speed Sign Recognition – Information Messages.....	319
Stability Control Indicator.....	233
Stability Control.....	231
Stability Control – Troubleshooting.....	234
Stability Control – Troubleshooting.....	234
Stability Control – Information Messages.....	234
Starter Switch	
See: Ignition Switch.....	170
Starting and Stopping the Engine – Precautions.....	170
Starting and Stopping the Engine.....	170
Automatic Engine Stop.....	174
Engine Block Heater.....	172
Starting and Stopping the Engine – Troubleshooting.....	176
Starting the Engine.....	171
Stopping the Engine.....	173
Starting and Stopping the Engine – Troubleshooting.....	176
Starting and Stopping the Engine – Frequently Asked Questions.....	177
Starting and Stopping the Engine – Information Messages.....	176
Starting and Stopping the Engine – Warning Lamps.....	176
Starting the Engine.....	171
Restarting the Engine After Stopping It.....	172
Starting a Gasoline Engine.....	171
Status Bar.....	507
Steering.....	240
Electric Power Steering.....	240
Steering – Troubleshooting.....	240
Steering – Troubleshooting.....	240
Steering – Frequently Asked Questions.....	242
Steering – Information Messages.....	241
Steering – Warning Indicators.....	240
Steering Wheel - Excluding: Raptor.....	30
Steering Wheel - Raptor.....	31
Steering Wheel.....	90
Stopping the Engine.....	179
Stopping the Engine When Your Vehicle is Moving.....	174
Stopping the Engine When Your Vehicle is Stationary.....	173
Storage.....	168
Center Console.....	169
Cup Holders.....	168
Glasses Holder.....	169
Glove Compartment.....	168
Under Seat Storage.....	169
Storing Your Vehicle.....	431
Sunroof	
See: Moonroof.....	114
SVT.....	117
Switching Active Park Assist On and Off - Vehicles With: Fully Active Park Assist.....	255

Index

Switching Active Park Assist On and Off - Vehicles With: Semi Active Park Assist.....	256
Switching Adaptive Cruise Control On and Off.....	266
Switching Air Conditioning On and Off.....	137
Switching All of the Interior Lamps On and Off.....	106
Switching Android Auto On and Off.....	519
Switching Apple CarPlay On and Off.....	519
Switching Auto Hold On and Off.....	227
Switching Auto-Start-Stop On and Off.....	179
Switching Blind Spot Information System On and Off.....	302
Switching Climate Control On and Off.....	137
Switching Cross Traffic Alert On and Off.....	308
Switching Cruise Control On and Off.....	261
Switching Driver Alert On and Off.....	322
Switching Four-Wheel Drive On and Off.....	203
Switching From Adaptive Cruise Control to Cruise Control.....	270
Switching From Intelligent Speed Limiter to Speed Limiter.....	288
Switching Hill Start Assist On and Off.....	226
Switching Maximum Cooling On and Off.....	137
Switching Maximum Defrost On and Off.....	137
Switching Parking Aid On and Off.....	243
Switching Pre-Collision Assist On and Off.....	312
Switching Rear Occupant Alert System On and Off.....	154
Switching Recirculated Air On and Off.....	137
Switching Repeat Mode On and Off.....	498
Switching Reverse Brake Assist On and Off.....	223
Switching Shuffle Mode On and Off.....	498
Switching Stability Control On and Off.....	232
Switching Text Message Notification On and Off.....	517
Switching the Audio Unit On and Off.....	498
Switching the Electronic Locking Differential On and Off - Excluding: Raptor.....	209
Switching the Electronic Locking Differential On and Off - Raptor.....	210
Switching the Front Interior Lamps On and Off.....	106
Switching the Hazard Flashers On and Off.....	377
Switching the Heated Rear Window On and Off.....	138
Switching the Heated Steering Wheel On and Off.....	91
Switching the Intelligent Speed Limiter On and Off.....	287
Switching the Lane Keeping System Mode.....	291
Switching the Lane Keeping System On and Off.....	291
Switching the Rear Interior Lamps On and Off.....	106
Switching Traction Control On and Off.....	229
Switching Trail Control On and Off.....	235
Switching Trailer Backup Assistance On and Off.....	348
Switching Trailer Reverse Guidance On and Off.....	359
Switching Trailer Sway Control On and Off.....	344
Switching Trail Turn Assist On and Off.....	238
Symbols Glossary.....	22
Symbols Used on Your Vehicle.....	22
System Update See: Software Update Settings.....	524
See: Vehicle Software Updates.....	524

Index

T	
Tachometer.....	117
Tailgate Precautions.....	85
Tailgate.....	85
Opening the Tailgate.....	85
Tailgate Work Surface.....	85
Team RS.....	17
Technical Specifications	
See: Capacities and Specifications.....	471
Temporary Neutral Mode - Vehicles	
With: Electronic Shift.....	193
Entering Temporary Neutral Mode.....	193
Exiting Temporary Neutral Mode.....	194
How Does Temporary Neutral Mode	
Work.....	193
Temporary Neutral Mode Limitations.....	193
The Better Business Bureau Auto Line	
Program.....	538
The Mediation and Arbitration	
Program.....	539
Third Party Software Copyright	
Acknowledgment.....	541
Tire Care.....	447
Tire Pressure Monitoring System	
Limitations.....	453
Tire Pressure Monitoring System	
Overview.....	452
Tire Pressure Monitoring System	
Precautions.....	453
Tire Pressure Monitoring System.....	452
Tire Pressure Monitoring System –	
Troubleshooting.....	454
Tire Pressure Monitoring System –	
Troubleshooting.....	454
Tire Pressure Monitoring System –	
Information Messages.....	455
Tire Pressure Monitoring System – Warning	
Lamps.....	454
Tire Replacement Requirements.....	440
Tire Rotation.....	450
Towing a Trailer Limitations.....	335
Towing a Trailer Precautions.....	334
Towing a Trailer.....	334
Towing a Trailer – Troubleshooting.....	339
Towing Weights and Dimensions.....	337
Towing a Trailer –	
Troubleshooting.....	339
Towing a Trailer – Information	
Messages.....	339
Towing Weights and Dimensions.....	337
Calculating the Maximum Loaded Trailer	
Weight for Your Vehicle.....	338
Recommended Towing Weights.....	337
What Is the Maximum Loaded Trailer	
Weight.....	338
Towing Your Vehicle Precautions.....	385
Towing Your Vehicle.....	385
Traction Control Indicator.....	229
Traction Control.....	229
Traction Control – Troubleshooting.....	230
Traction Control –	
Troubleshooting.....	230
Traction Control – Information	
Messages.....	230
Traction Control – Warning Lamps.....	230
Trail Control Indicators.....	236
Trail Control Limitations.....	235
Trail Control.....	235
Trail Control – Troubleshooting.....	237
Trail Control – Troubleshooting.....	237
Trail Control – Information	
Messages.....	237
Trailer Backup Assistance	
Precautions.....	345
Trailer Backup Assistance.....	345
Setting Up the Trailer Backup Assistance	
for a Conventional Trailer.....	345
Trailer Backup Assistance –	
Troubleshooting.....	352
Trailer Backup Assistance –	
Troubleshooting.....	352
Trailer Backup Assistance – Frequently	
Asked Questions.....	354
Trailer Backup Assistance – Information	
Messages.....	352
Trailer Brake Precautions.....	334
Trailer Lighting Check.....	332
Trailer Reverse Guidance	
Precautions.....	356
Trailer Reverse Guidance.....	356
Setting Up Trailer Reverse Guidance for a	
Conventional Trailer.....	356

Index

Trailer Reverse Guidance – Troubleshooting.....	361
Trailer Reverse Guidance – Troubleshooting.....	361
Trailer Reverse Guidance – Frequently Asked Questions.....	363
Trailer Reverse Guidance – Information Messages.....	361
Trailer Sway Control Precautions.....	344
Trailer Sway Control.....	344
Trailer Towing Hints.....	335
Trailer Towing Navigation.....	523
Trail Turn Assist Indicators.....	238
Trail Turn Assist Limitations.....	238
Trail Turn Assist Precautions.....	238
Trail Turn Assist.....	238
Trail Turn Assist – Troubleshooting.....	239
Trail Turn Assist – Troubleshooting.....	239
Trail Turn Assist – Frequently Asked Questions.....	239
Trail Turn Assist – Information Messages.....	239
Transfer Case Fluid Capacity and Specification.....	205
Transmission Fluid Temperature Gauge - Vehicles With: 12 Inch Screen.....	119
Transmission Fluid Temperature Gauge - Vehicles With: 8 Inch Screen.....	118
Transporting the Vehicle.....	382
Trip Computer.....	134
U	
Under Hood Fuse Box.....	386
Accessing the Under Hood Fuse Box.....	386
Identifying the Fuses in the Under Hood Fuse Box.....	387
Locating the Under Hood Fuse Box.....	386
Under Hood Overview - 2.3L EcoBoost™.....	403
Under Hood Overview - 2.7L EcoBoost™.....	404
Under Hood Overview - 3.0L EcoBoost™.....	405
Under Seat Storage.....	169
Locating the Under Seat Storage Compartment.....	169
Unique Features.....	40
USB Ports.....	161
Using Alexa Built-In.....	512
Using a Slide-In Camper.....	324
Using Auto Hold.....	227
Using Bead-Lock Wheels - Raptor.....	445
Using Keyless Entry.....	83
Using Snow Chains - Excluding: Raptor.....	442
Using Snow Chains - Raptor.....	443
Using the Instrument Cluster Display Controls - Excluding: Raptor.....	125
Using the Instrument Cluster Display Controls - Raptor.....	125
Using the Integrated Trailer Brake Controller.....	340
Using the Remote Control.....	71
Using the Trailer Backup Assistance Controller.....	349
Using the Trailer Backup Assistance Views.....	349
Using This Publication.....	21
Using Trailer Reverse Guidance Views.....	359
V	
Vehicle Care.....	426
Cleaning the Exterior.....	426
Cleaning the Interior.....	428
Vehicle Identification Number.....	492
Locating the Vehicle Identification Number.....	492
Vehicle Identification Number Overview.....	492
Vehicle Identification.....	492
Vehicle Identification Number.....	492
Vehicle Interior - Excluding: Raptor.....	34
Vehicle Interior - Raptor.....	35
Vehicle Software Updates.....	524
Vehicle System Reset.....	526
Vehicle Wi-Fi Hotspot – Troubleshooting.....	497
Vehicle Wi-Fi Hotspot – Frequently Asked Questions.....	497
Vehicle Wi-Fi Hotspot.....	496
Vehicle Wi-Fi Hotspot – Troubleshooting.....	497

Index

Ventilation	
See: Climate Control - Vehicles With:	
Automatic Temperature Control.....	137
See: Climate Control - Vehicles With: Manual Temperature Control.....	140
Venting the Moonroof.....	114
Viewing the Tire Pressures.....	454
Visual Search.....	30
Voice Interaction Examples.....	510
Voice Interaction.....	510
W	
Warranty Information.....	609
Washer Fluid Specification.....	487
Washers.....	94
Adding Washer Fluid.....	95
Switching the Courtesy Wipe On and Off.....	94
Using the Windshield Washer.....	94
Washer Fluid Specification.....	95
Washer Precautions.....	94
Washers	
See: Wipers and Washers.....	92
Water Wading - Excluding: Raptor.....	367
Water Wading - Raptor.....	368
Waxing Your Vehicle.....	430
Waypoints.....	522
Adding a Waypoint.....	522
Editing Waypoints.....	522
What Are the Auxiliary Switches.....	529
What Are the Instrument Cluster Indicators.....	120
What Are the Instrument Cluster Warning Lamps.....	119
What Is 911 Assist.....	69
What Is a Connected Vehicle.....	493
What Is Active Park Assist.....	255
What Is Alexa Built-In.....	512
What Is Auto-Start-Stop.....	179
What Is Blind Spot Information System.....	301
What Is Cross Traffic Alert.....	307
What Is Cruise Control.....	261
What Is Drive Mode Control.....	278
What Is Driver Alert.....	321
What Is Ford Protect.....	532
What Is Hill Start Assist.....	226
What Is Keyless Entry.....	83
What Is Pre-Collision Assist.....	310
What Is Remote Start.....	135
What Is Reverse Brake Assist.....	222
What Is Speed Sign Recognition.....	318
What Is the 360 Degree Camera.....	251
What Is the Cabin Air Filter.....	143
What Is the Catalytic Converter.....	188
What Is the Electric Parking Brake.....	219
What Is the Electronic Locking Differential - Excluding: Raptor.....	208
What Is the Electronic Locking Differential - Raptor.....	208
What Is the Gross Axle Weight Rating.....	324
What Is the Gross Combined Weight Rating.....	324
What Is the Gross Vehicle Weight Rating.....	324
What Is the Integrated Trailer Brake Controller.....	340
What Is the Intelligent Speed Limiter.....	287
What Is the Lane Keeping System.....	290
What Is the Memory Function.....	156
What Is the Personal Safety System.....	59
What Is the Power Outlet.....	163
What Is the Rear Occupant Alert System.....	154
What Is the Rear View Camera - Vehicles With: Analog Rear View Camera.....	248
What Is the Rear View Camera - Vehicles With: Digital Rear View Camera.....	248
What Is the Tire Pressure Monitoring System.....	452
What Is the Wireless Accessory Charger.....	166
What Is Traction Control.....	229
What Is Trail Control.....	235
What Is Trailer Backup Assistance.....	345
What Is Trailer Reverse Guidance.....	356
What Is Trail Turn Assist.....	238
What Is Voice Interaction.....	510
Wheel and Tire Information.....	433
Wheel Nuts.....	470

Index

Wi Fi	
See: Changing the Vehicle Wi-Fi Hotspot Name or Password.....	497
See: Connecting the Vehicle to a Wi-Fi Network.....	493
See: Creating a Vehicle Wi-Fi Hotspot.....	496
See: Vehicle Wi-Fi Hotspot.....	496
Window Bounce-Back.....	109
Overriding Window Bounce-Back.....	109
What Is Window Bounce-Back.....	109
Windows.....	108
Global Opening and Closing.....	108
Window Bounce-Back.....	109
Wipers and Washers – Troubleshooting.....	95
Wipers and Washers – Frequently Asked Questions.....	95
Wipers and Washers – Warning Lamps.....	95
Wipers and Washers Videos.....	95
Wipers and Washers.....	92
Autowipers.....	92
Washers.....	94
Wipers.....	92
Wipers and Washers – Troubleshooting.....	95
Wipers.....	92
Switching Windshield Wipers On and Off.....	92
Wiper Precautions.....	92
Wireless Accessory Charger Precautions.....	166
Wireless Accessory Charger – Troubleshooting.....	167
Wireless Accessory Charger – Information Messages.....	167
Wireless Accessory Charger.....	166
Wireless Accessory Charger – Troubleshooting.....	167

