

Ford**Galaxy**
Ford**S-MAX**
Owner's handbook

Feel the difference



The information contained in this publication was correct at the time of going to print. In the interest of development the right is reserved to change specifications, design or equipment at any time without notice and without incurring any obligations. This publication, or part thereof, may not be reproduced nor translated without our approval. Errors and omissions excepted.

© Ford Motor Company 2008

All rights reserved.

Part number: 9M2J-19A321-DA (CG3533en) 11/2008 20081222140152



Mixed Sources

Product group from well-managed
forests, controlled sources and
recycled wood or fiber

www.fsc.org Cert no. SGS-COC-2452
© 1996 Forest Stewardship Council

Table of contents

Introduction

| | |
|----------------------------|---|
| About this handbook..... | 7 |
| Symbols glossary..... | 7 |
| Parts and accessories..... | 8 |

Quick start

| | |
|------------------|----|
| Quick start..... | 11 |
|------------------|----|

Child safety

| | |
|-----------------------------|----|
| Child seats..... | 20 |
| Booster cushions..... | 21 |
| Child seat positioning..... | 22 |
| ISOFIX anchor points..... | 25 |
| Child safety locks..... | 26 |

Occupant protection

| | |
|--|----|
| Principle of operation..... | 27 |
| Fastening the seat belts..... | 29 |
| Seat belt height adjustment..... | 30 |
| Seat belt reminder..... | 31 |
| Using seat belts during pregnancy..... | 31 |
| Disabling the passenger airbag..... | 31 |

Keys and remote controls

| | |
|---|----|
| General information on radio frequencies..... | 33 |
| Programming the remote control..... | 33 |
| Changing the remote control battery..... | 33 |

Locks

| | |
|---------------------------------|----|
| Locking and unlocking..... | 37 |
| Global opening and closing..... | 39 |

Engine immobiliser

| | |
|---------------------------------------|----|
| Principle of operation..... | 41 |
| Coded keys..... | 41 |
| Arming the engine immobiliser..... | 41 |
| Disarming the engine immobiliser..... | 41 |

Alarm

| | |
|-----------------------------|----|
| Principle of operation..... | 42 |
| Arming the alarm..... | 44 |
| Disarming the alarm..... | 44 |

Steering wheel

| | |
|-----------------------------------|----|
| Adjusting the steering wheel..... | 45 |
| Audio control..... | 45 |

Wipers and washers

| | |
|------------------------------------|----|
| Windscreen wipers..... | 47 |
| Autowipers..... | 47 |
| Windscreen washers..... | 48 |
| Rear window wiper and washers..... | 48 |
| Headlamp washers..... | 49 |
| Checking the wiper blades..... | 49 |
| Changing the wiper blades..... | 49 |
| Technical specifications..... | 51 |

Lighting

| | |
|---|----|
| Lighting control..... | 52 |
| Autolamps..... | 53 |
| Front fog lamps..... | 53 |
| Rear fog lamps..... | 53 |
| Headlamp levelling..... | 53 |
| Hazard warning flashers..... | 55 |
| Adaptive front lighting system (AFS)..... | 55 |
| Direction indicators..... | 57 |
| Interior lamps..... | 57 |
| Removing a headlamp..... | 58 |
| Changing a bulb..... | 59 |
| Bulb specification chart..... | 69 |

Windows and mirrors

| | |
|--------------------------------|----|
| Electric windows..... | 71 |
| Exterior mirrors..... | 73 |
| Electric exterior mirrors..... | 73 |
| Auto-dimming mirror..... | 74 |

Table of contents

| | |
|---------------------------|----|
| Rear quarter windows..... | 75 |
|---------------------------|----|

Instruments

| | |
|--------------------------------------|----|
| Gauges..... | 77 |
| Warning lamps and indicators..... | 79 |
| Audible warnings and indicators..... | 81 |

Information displays

| | |
|----------------------------|----|
| General information..... | 82 |
| Trip computer..... | 91 |
| Personalised settings..... | 93 |
| Information messages..... | 95 |

Climate control

| | |
|---------------------------------|-----|
| Principle of operation..... | 104 |
| Air vents..... | 104 |
| Manual climate control..... | 105 |
| Automatic climate control..... | 108 |
| Heated windows and mirrors..... | 112 |
| Auxiliary heater..... | 113 |

Seats

| | |
|--------------------------------------|-----|
| Sitting in the correct position..... | 118 |
| Manual seats..... | 118 |
| Electric seats..... | 119 |
| Head restraints..... | 121 |
| Rear seats..... | 121 |
| Heated seats..... | 126 |
| Ventilated seats..... | 126 |
| Front seat armrest..... | 127 |

Convenience features

| | |
|---------------------------------|-----|
| Sun blinds..... | 128 |
| Instrument lighting dimmer..... | 128 |
| Clock..... | 128 |
| Cigar lighter..... | 129 |
| Ashtray..... | 129 |
| Auxiliary power sockets..... | 129 |
| Cup holders..... | 130 |

| | |
|--------------------------------------|-----|
| Glove box..... | 130 |
| Storage compartments..... | 131 |
| Map pockets..... | 133 |
| Seat back trays..... | 133 |
| Glasses holder..... | 134 |
| Memory function..... | 134 |
| Childminder mirror..... | 135 |
| CD changer..... | 135 |
| Auxiliary input (AUX IN) socket..... | 135 |
| USB port..... | 136 |

Starting the engine

| | |
|--------------------------------------|-----|
| General information..... | 137 |
| Ignition switch..... | 137 |
| Steering wheel lock..... | 137 |
| Starting a petrol engine..... | 137 |
| Starting a petrol engine - E85..... | 138 |
| Starting a diesel engine..... | 139 |
| Diesel particulate filter (DPF)..... | 140 |
| Switching off the engine..... | 140 |
| Engine heater..... | 140 |

Fuel and refuelling

| | |
|-------------------------------|-----|
| Safety precautions..... | 141 |
| Fuel quality - Petrol..... | 141 |
| Fuel quality - E85..... | 141 |
| Fuel quality - Diesel..... | 141 |
| Catalytic converter..... | 142 |
| Fuel filler flap..... | 142 |
| Refuelling..... | 143 |
| Refuelling - E85..... | 143 |
| Fuel consumption..... | 143 |
| Technical specifications..... | 143 |

Transmission

| | |
|-----------------------------|-----|
| Manual transmission..... | 146 |
| Automatic transmission..... | 146 |

Table of contents

Brakes

| | |
|-----------------------------------|-----|
| Principle of operation..... | 149 |
| Hints on driving with ABS..... | 149 |
| Parking brake..... | 149 |
| Electric parking brake (EPB)..... | 150 |

Stability control

| | |
|------------------------------|-----|
| Principle of operation..... | 153 |
| Using stability control..... | 153 |

Hill launch assist (HLA)

| | |
|-----------------------------|-----|
| Principle of operation..... | 154 |
| Using HLA..... | 154 |

Active suspension

| | |
|------------------------------|-----|
| Principle of operation..... | 157 |
| Using active suspension..... | 157 |

Parking aid

| | |
|-----------------------------|-----|
| Principle of operation..... | 158 |
| Using the parking aid..... | 158 |

Cruise control

| | |
|-----------------------------|-----|
| Principle of operation..... | 160 |
| Using cruise control..... | 160 |

Adaptive cruise control (ACC)

| | |
|-----------------------------|-----|
| Principle of operation..... | 162 |
| Using ACC..... | 163 |
| Forward alert function..... | 166 |

Load carrying

| | |
|-------------------------------|-----|
| General information..... | 168 |
| Luggage anchor points..... | 169 |
| Sliding loadspace floor..... | 171 |
| Rear under floor storage..... | 172 |
| Cargo nets..... | 173 |
| Luggage covers..... | 176 |

| | |
|-----------------------------------|-----|
| Roof racks and load carriers..... | 176 |
| Load retaining fixtures..... | 177 |
| Dog guard..... | 180 |

Towing

| | |
|---------------------------|-----|
| Towing a trailer..... | 183 |
| Detachable tow ball..... | 183 |
| Retractable tow ball..... | 186 |

Driving hints

| | |
|----------------------------|-----|
| Running-in..... | 190 |
| Driving through water..... | 190 |

Emergency equipment

| | |
|-----------------------|-----|
| First aid kit..... | 191 |
| Warning triangle..... | 191 |

Status after a collision

| | |
|--|-----|
| Inspecting safety system components..... | 192 |
|--|-----|

Fuses

| | |
|-------------------------------|-----|
| Fuse box locations..... | 193 |
| Changing a fuse..... | 194 |
| Fuse specification chart..... | 195 |

Vehicle recovery

| | |
|--|-----|
| Towing points..... | 204 |
| Towing the vehicle on four wheels..... | 204 |

Maintenance

| | |
|---|-----|
| General information..... | 206 |
| Opening and closing the bonnet..... | 206 |
| Engine compartment overview - 2.0L Duratec-HE (M14)..... | 208 |
| Engine compartment overview - 2.3L Duratec-HE (M14)..... | 209 |
| Engine compartment overview - 2.5L Duratec (V15)..... | 210 |
| Engine compartment overview - 1.8L Duratorq-TDCi (Lynx) Diesel..... | 211 |

Table of contents

| | |
|--|-----|
| Engine compartment overview - 2.0L Duratorq-TDCi (DW) Diesel..... | 212 |
| Engine compartment overview - 2.2L Duratorq-TDCi (DW) Diesel..... | 213 |
| Engine oil dipstick - 2.0L Duratec-HE (M14)/2.3L Duratec-HE (M14)..... | 214 |
| Engine oil dipstick - 2.5L Duratec (V15)..... | 214 |
| Engine oil dipstick - 1.8L Duratorq-TDCi (Lynx) Diesel..... | 214 |
| Engine oil dipstick - 2.0L Duratorq-TDCi (DW) Diesel/2.2L Duratorq-TDCi (DW) Diesel..... | 214 |
| Engine oil check..... | 215 |
| Engine coolant check..... | 215 |
| Brake and clutch fluid check..... | 216 |
| Power steering fluid check..... | 216 |
| Washer fluid check..... | 216 |
| Technical specifications..... | 217 |

Vehicle care

| | |
|-----------------------------------|-----|
| Cleaning the exterior..... | 220 |
| Cleaning the interior..... | 220 |
| Repairing minor paint damage..... | 221 |

Vehicle battery

| | |
|--------------------------------|-----|
| Using booster cables..... | 222 |
| Battery connection points..... | 223 |

Wheels and tyres

| | |
|--------------------------------------|-----|
| General information..... | 224 |
| Changing a road wheel..... | 224 |
| Tyre repair kit..... | 227 |
| Run flat tyres..... | 232 |
| Tyre care..... | 233 |
| Using winter tyres..... | 233 |
| Using snow chains..... | 233 |
| Tyre pressure monitoring system..... | 234 |
| Technical specifications..... | 235 |

Vehicle identification

| | |
|--|-----|
| Vehicle identification plate..... | 238 |
| Vehicle identification number (VIN)..... | 238 |

Technical specifications

| | |
|-------------------------------|-----|
| Technical specifications..... | 239 |
|-------------------------------|-----|

Telephone

| | |
|---|-----|
| General information..... | 245 |
| Telephone setup..... | 245 |
| Bluetooth setup..... | 246 |
| Telephone controls..... | 247 |
| Using the telephone - Vehicles Without: Navigation System..... | 247 |
| Using the telephone - Vehicles With: Navigation System..... | 250 |

Voice control

| | |
|---------------------------------|-----|
| Principle of operation..... | 252 |
| Using voice control..... | 252 |
| Audio unit commands..... | 253 |
| Telephone commands..... | 264 |
| Navigation system commands..... | 268 |
| Climate control commands..... | 268 |

Connectivity

| | |
|------------------------------------|-----|
| General information..... | 271 |
| Connecting an external device..... | 272 |
| Using a USB device..... | 272 |
| Using an iPod..... | 275 |

Navigation introduction

| | |
|------------------|-----|
| Road Safety..... | 279 |
|------------------|-----|

Navigation system

| | |
|----------------------|-----|
| Getting started..... | 280 |
|----------------------|-----|

Appendices

| | |
|---------------------|-----|
| Type approvals..... | 282 |
| Type approvals..... | 287 |

Table of contents

| | |
|------------------------------------|-----|
| Type approvals..... | 287 |
| Type approvals..... | 287 |
| Electromagnetic compatibility..... | 288 |

Introduction

ABOUT THIS HANDBOOK

Thank you for choosing Ford. We recommend that you take some time to get to know your vehicle by reading this handbook. The more that you know about it, the greater the safety and pleasure you will get from driving it.

Note: *This handbook describes product features and options available throughout the range, sometimes even before they are generally available. It may describe options not fitted to your vehicle.*

Note: *Always use and operate your vehicle in line with all applicable laws and regulations.*

Note: *Pass on this handbook when selling your vehicle. It is an integral part of the vehicle.*

This vehicle has received both the endorsement of TÜV, the accredited international testing organisation, and been awarded the British Allergy Foundation's Seal of Approval' for its allergy-friendly properties.

All materials used in the manufacture of the interior of this vehicle meet strict requirements of the TÜV TOXPROOF Criteria Catalogue for Vehicle Interiors by TÜV Produkt und Umwelt GmbH and are designed to minimize the risk of allergic reactions.

Additionally an efficient pollen filter protects the passengers against allergen particles in the outdoor air.

The British Allergy Foundation (BAF) considers that these products may, in proper use, reduce exposure to chromium, nickel, latex, grass pollen and other sensitizing substances and volatile organic compounds.

Assessment carried out by Allergy UK indicate that an individual's exposure can be reduced but this does not mean that an individual's allergic symptoms will necessarily diminish. Allergy UK's opinion applies only to the products and allergens stated.

The British Allergy Foundation's Seal of Approval is a European Community registered trademark.

For more info. Contact TÜV at www.tuv.com or the British Allergy Foundation (Charity Reg.No.1094231) at www.allergyuk.org or ring their English only Helpline at UK 44-(0)-1322-619898.

SYMBOLS GLOSSARY

Symbols in this handbook

WARNING



You risk death or serious injury to yourself and others if you do not follow the instructions highlighted by the warning symbol.

CAUTION



You risk damaging your vehicle if you do not follow the instructions highlighted by the caution symbol.

Symbols on your vehicle



When you see these symbols, read and follow the relevant instructions in this handbook before touching or attempting adjustment of any kind.

Introduction

PARTS AND ACCESSORIES

Now you can be sure that your Ford parts are Ford parts

Your Ford has been built to the highest standards using high quality Ford Original Parts. As a result, you can enjoy driving it for many years.

Should the unexpected occur and a major part needs replacing, we recommend that you accept nothing less than Ford Original Parts.

The use of Ford Original Parts ensures that your vehicle is repaired to its pre-accident condition and maintains its maximum residual value.

Ford Original Parts match Ford's stringent safety requirements and high standards of fit, finish and reliability. Quite simply, they represent the best overall repair value, including parts and labour costs.

Now it is easier to tell if you have really been given Ford Original Parts. The Ford logo is clearly visible on the following parts if they are Ford Original Parts. If your vehicle has to be repaired, look for the clearly visible Ford branding and make sure that only Ford Original Parts have been used.

Look for the Ford logo on the following parts

Sheet metal

- Wing
- Bonnet
- Doors
- Luggage compartment lid or tailgate

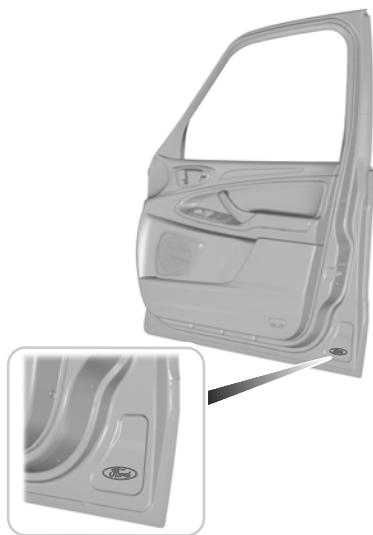

E94714

Bumper and radiator grille

- Radiator grille
- Front and rear bumper



E94715

Introduction

Exterior mirror



E94716

Glass

- Rear window
- Glass roof
- Side glass
- Windscreen



E94717

Lighting

- Rear lamps
- Headlamp

Introduction

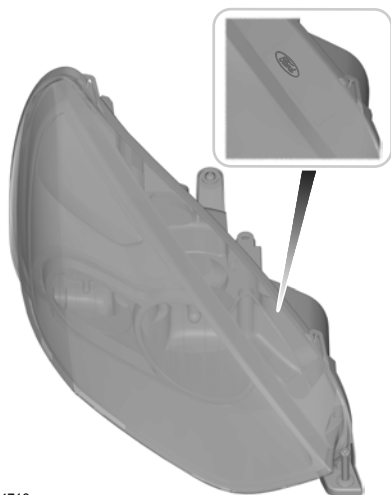

E94718

Quick start

QUICK START

Instrument panel overview - left-hand drive

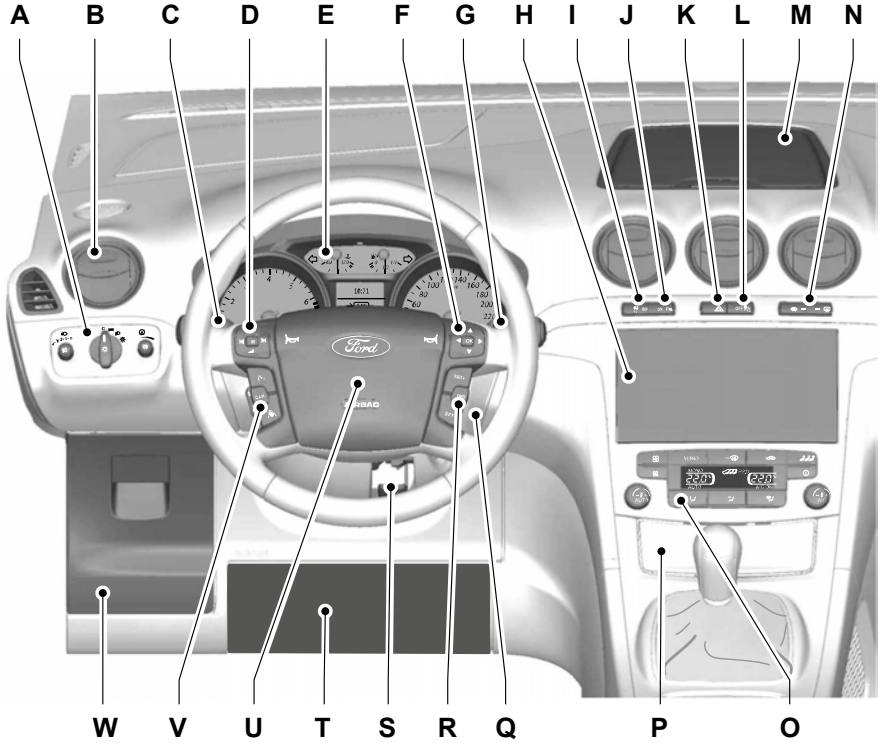

E74123

Quick start

Instrument panel overview - right-hand drive

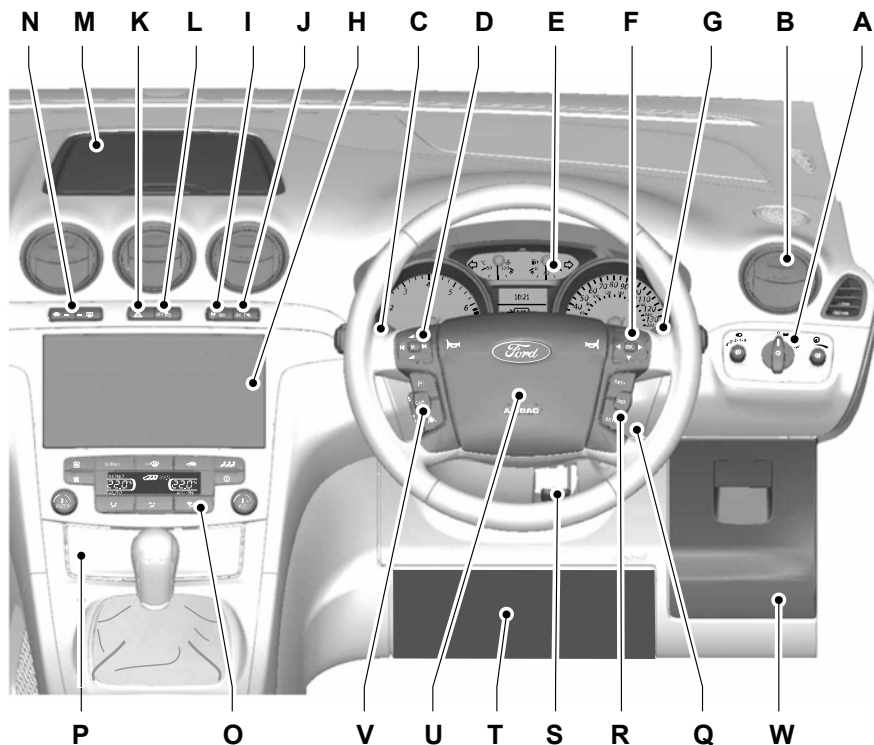

E75798

- A Lighting controls. See **Lighting control** (page 52).
- B Air vents. See **Air vents** (page 104).
- C Direction indicators. See **Direction indicators** (page 57). Telephone control buttons. See **Telephone controls** (page 247). Voice control buttons. See **Using voice control** (page 252).
- D Audio controls. See **Audio control** (page 45).
- E Instrument cluster. See **Gauges** (page 77).

Quick start

- F Information display controls. See **Information displays** (page 82).
- G Wiper lever. See **Windscreen wipers** (page 47).
- H Audio or navigation unit. See separate handbook.
- I Stability control (ESP) switch. See **Using stability control** (page 153).
- J Parking aid switch. See **Using the parking aid** (page 158).
- K Hazard warning flasher switch. See **Hazard warning flashers** (page 55).
- L Passenger airbag deactivation warning lamp. See **Disabling the passenger airbag** (page 31).
- M Storage compartment. See **Storage compartments** (page 131).
- N Heated windscreen and heated rear window switches. See **Heated windows and mirrors** (page 112).
- O Climate controls. See **Manual climate control** (page 105). See **Automatic climate control** (page 108).
- P Cigar lighter. See **Cigar lighter** (page 129).
- Q Ignition switch.
- R Cruise control switches. See **Using cruise control** (page 160). Adaptive cruise control (ACC) switches. See **Using ACC** (page 163).
- S Steering wheel adjustment lever. See **Adjusting the steering wheel** (page 45).
- T Driver Knee airbag. See **Principle of operation** (page 27).
- U Horn.
- V Cruise control switches. See **Using cruise control** (page 160). Adaptive cruise control (ACC) switches. See **Using ACC** (page 163).
- W Storage compartment. See **Storage compartments** (page 131).

Adjusting the steering wheel

WARNING



Never adjust the steering wheel when the vehicle is moving.

Quick start

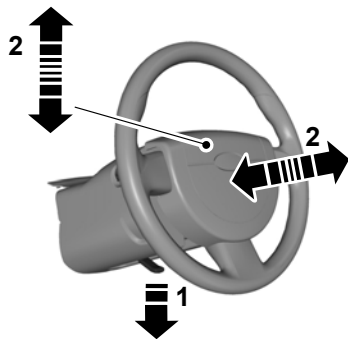

E95178

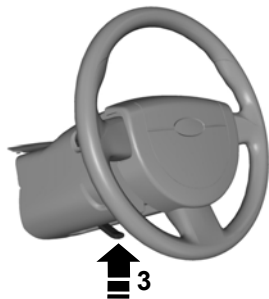

E95179

See **Adjusting the steering wheel** (page 45).

Engine idle speed after starting

The engine may idle at a higher speed than normal immediately after starting from cold.

See **Starting the engine** (page 137).

Electric folding mirrors



E72623

See **Electric exterior mirrors** (page 73).

Reverse mirror dipping

Depending on the selected mirror position, the relevant exterior mirror will dip whenever you select reverse gear, giving you a view of the kerb.

When you first use this feature, the mirrors will dip to a preset position. You can programme the degree of dipping.

See **Electric exterior mirrors** (page 73).

Quick start

Information displays

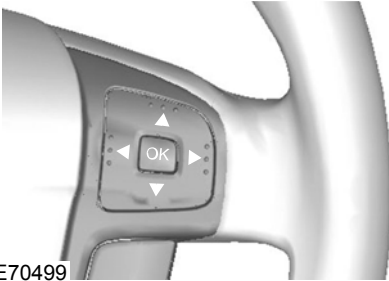

E70499

Use the arrow buttons to navigate through the menus and press **OK** to make a selection.

See **Information displays** (page 82).

Autolamps

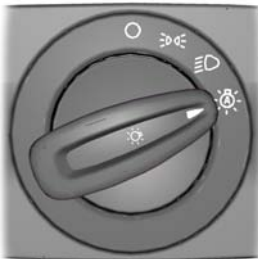

E70719

The headlamps will come on and go off automatically depending on the ambient light.

See **Lighting control** (page 52).

Direction indicators

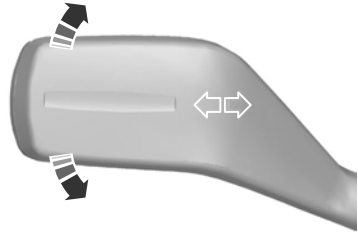

E70727

Note: Tap the lever up or down to make the direction indicators flash only three times.

Autowipers

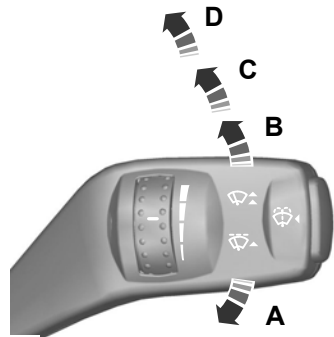

E70696

- A Single wipe
- B Autowipers
- C Normal wipe
- D High speed wipe

Quick start

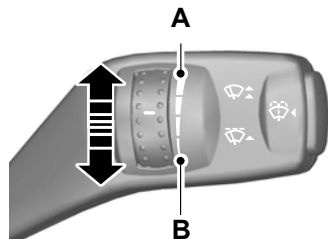

E70316

- A High sensitivity
- B Low sensitivity

See **Autowipers** (page 47).

Memory function

WARNING



Do not use the memory store function when the vehicle is moving.

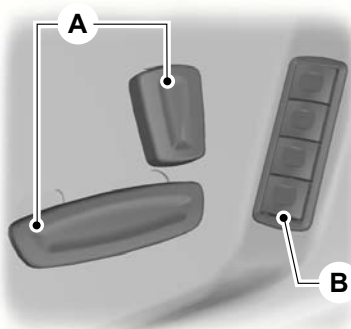

E86768

- A Seat adjustment controls
- B Memory pre-set buttons

1. Turn the ignition on.

2. Adjust the seat and exterior mirrors to the desired position.
3. Press and hold the desired pre-set button **B** until a single chime sounds to confirm.

See **Memory function** (page 134).

Manual climate control

Heating the interior quickly



E71377

Cooling the interior quickly

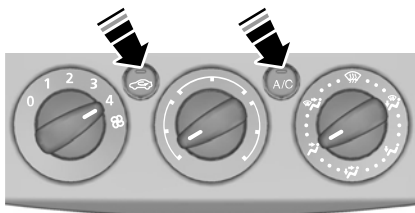

E71381

Quick start

Defrosting and demisting the windscreen

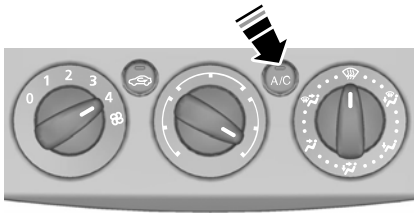

E71382

See **Manual climate control** (page 105).

Automatic climate control



E70304

See **Automatic climate control** (page 108).

Rear seat air vents

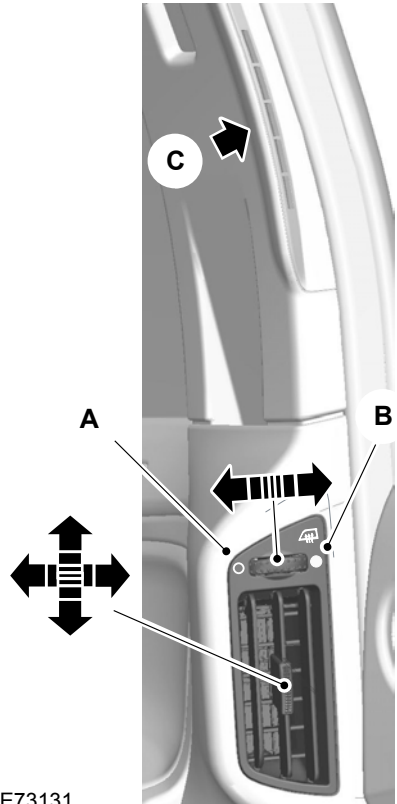

E73131

- A Air flow through lower air vent
- B Air flow through upper air vent
- C Upper air vent

Select position **B** to defrost or demist the rear side windows.

Quick start

Manual transmission

Selecting reverse gear

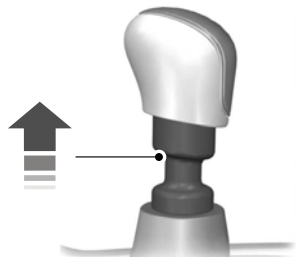

E99067

On some vehicles it is necessary to raise the collar whilst selecting reverse gear.

See **Manual transmission** (page 146).

Automatic transmission

Selector lever positions



E80836

- A Park
- B Reverse
- C Neutral

- D Drive
- S Manual shifting and sport mode

WARNING

 Apply the brakes before moving the selector lever and keep them applied until you are ready to move off.

See **Automatic transmission** (page 146).

Electric parking brake (EPB)

Applying the EPB



E70528

Releasing the EPB manually

Note: To release the EPB, the ignition must be in position **II**.

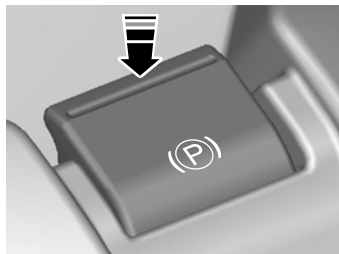

E70529

Quick start

Hold the brake pedal depressed and press down the switch.

Automatic release - Drive away release (DAR)

Engage first or reverse gear, move off as normal, the EPB will be released automatically.

See **Electric parking brake (EPB)** (page 150).







Child safety

CHILD SEATS



E68916

WARNINGS

-  Secure children that are less than 150 centimetres tall or less than 12 years of age in a suitable, approved child restraint, in the rear seat.
-  Original text according to ECE R94.01: Extreme Hazard! Do not use a rearward facing child restraint on a seat protected by an air bag in front of it!
-  Read and follow the manufacturer's instructions when you are fitting a child restraint.
-  Do not modify child restraints in any way.
-  Do not hold a child on your lap when the vehicle is moving.
-  Do not leave unattended children in your vehicle.
-  If your vehicle has been involved in an accident, have the child restraints checked by properly trained technicians.

Note: *Mandatory use of child restraints varies from country to country.*

Only child restraints certified to ECE-R44.03 (or later) have been tested and approved for use in your vehicle. A choice of these are available from your Dealer.

Child restraints for different mass groups

Use the correct child restraint as follows:

Baby safety seat



E68918

Secure children that weigh less than 13 kilograms in a rearward facing baby safety seat (Group 0+) in the rear seat.

Child safety

Child safety seat









E68920

Secure children that weigh between 13 and 18 kilograms in a child safety seat (Group 1) in the rear seat.

BOOSTER CUSHIONS

WARNINGS

-  Do not install a booster seat or a booster cushion with only the lap strap of the seat belt.
-  Do not install a booster seat or a booster cushion with a seat belt that is slack or twisted.
-  Do not put the seat belt under your child's arm or behind its back.
-  Do not use pillows, books or towels to boost your child's height.
-  Make sure that your children sit in an upright position.
-  Secure children that weigh more than 15 kilograms but are less than 150 centimetres tall in a booster seat or a booster cushion.

CAUTION

-  When using a child seat on a rear seat, make sure that the child seat rests tightly against the vehicle seat. It may be necessary to lift or remove the head restraint. See **Head restraints** (page 121).

Booster seat (Group 2)



E70710

We recommend that you use a booster seat that combines a cushion with a backrest instead of a booster cushion only. The raised seating position will allow you to position the shoulder strap of the adult seat belt over the centre of your child's shoulder and the lap strap tightly across its hips.

Child safety



Booster cushion (Group 3)



E68924

CHILD SEAT POSITIONING

WARNINGS

- 
 When you are using a child restraint with a support leg on a second row seat, make sure that you locate the support leg securely on the under floor storage compartment lid. Make sure that you install the foam spacer correctly inside the storage compartment and that you position the lid correctly.
- 
 When using a forward facing child seat on a second or third row seat, always remove the head restraint from that seat.
- 
 When fitting a child seat using the vehicle seat belts make sure the belts are not slack.

Note: When using a child seat on a second row seat, adjust the second row seat to the most practical position for the driver.

Child seat positions

| Seating positions | Mass group categories | | | | |
|---|-----------------------|----------------|-------------------|-------------------------|-----------------|
| | 0 | 0+ | I | II | III |
| | Up to 10 kg | Up to 13 kg | 9 - 18 kg | 15 - 25 kg | 22 - 36 kg |
| | Baby safety seat | | Child safety seat | Booster seat or cushion | |
| Front passenger seat with airbag ON | X | X | UF ¹ | UF ¹ | UF ¹ |
| Front passenger seat with airbag OFF | U ¹ | U ¹ | U ¹ | U ¹ | U ¹ |
| Second row seats | U | U | U | U | U |
| Third row Galaxy | U | U | U | U | U |

Child safety

| Seating positions | Mass group categories | | | | |
|-------------------|-----------------------|-------------|-------------------|-------------------------|------------|
| | O | O+ | I | II | III |
| | Up to 10 kg | Up to 13 kg | 9 - 18 kg | 15 - 25 kg | 22 - 36 kg |
| | Baby safety seat | | Child safety seat | Booster seat or cushion | |
| Third row S-MAX | L, UF | L, UF | UF | UF | UF |

X Not suitable for children in this mass group.

U Suitable for universal category child restraints approved for use in this mass group.

U' Suitable for universal category child restraints approved for use in this mass group. However, we recommend that you secure children in a government approved child restraint, in the rear seat.

L Suitable only for the following rearward facing child restraints: Roemer Baby-Safe (E1-04301146), Roemer Baby-Safe Plus (E1-04301146), Britax Cosy Tot (E1-04301146), Britax Cosy Tot Premium (E1-04301146), Maxi-Cosi Cabrio (E4-44R-043517).

UF Suitable for universal category forward facing child restraints approved for use in this mass group.

UF' Suitable for universal category forward facing child restraints approved for use in this mass group. However, we recommend that you secure children in a government approved child restraint, in the rear seat.

ISOFIX child restraints

| Seating positions | Mass group categories | | | | |
|-----------------------------------|-----------------------|-------------|-------------------|-------------------------|------------|
| | O | O+ | I | II | III |
| | Up to 10 kg | Up to 13 kg | 9 - 18 kg | 15 - 25 kg | 22 - 36 kg |
| | Baby safety seat | | Child safety seat | Booster seat or cushion | |
| Second row seat ISOFIX restraints | IU | IU | IU | X | X |
| Second row seat ISOFIX classes* | E | C, D, E | A, B, B1, C, D | X | X |

X Not suitable for children in this mass group.

Child safety

IU Suitable for universal category ISOFIX child restraints approved for use in this mass group.

* As defined by ECE-R16.

Note: *When you are purchasing an ISOFIX restraint, make sure that you know the correct mass group and ISOFIX size class for the intended seating locations.*

Child safety

ISOFIX ANCHOR POINTS

WARNING

 Use an anti-rotation device when using the ISOFIX system. We recommend the use of a top tether or support leg.

Note: When you are purchasing an ISOFIX restraint, make sure that you know the correct mass group and ISOFIX size class for the intended seating locations. See **Child seat positioning** (page 22).

Your vehicle is fitted with ISOFIX anchor points that accommodate universally approved ISOFIX child restraints.

The ISOFIX system comprises two rigid attachment arms on the child restraint that attach to anchor points on the outboard rear seats, where the cushion and backrest meet. Tether anchor points are fitted behind the outboard rear seats for child restraints with a top tether.

Top tether anchor points



E75532



Attaching a child seat with top tethers

WARNING

 Do not attach a tether strap to anything other than the correct tether anchor point.

Note: Where applicable, remove the luggage cover to ease installation. See **Luggage covers** (page 176).

1. Remove the head restraint. See **Head restraints** (page 121).

WARNING

 Make sure that the top tether strap is not slack or twisted and is properly located on the anchor point.

2. Route the tether strap to the anchor point.

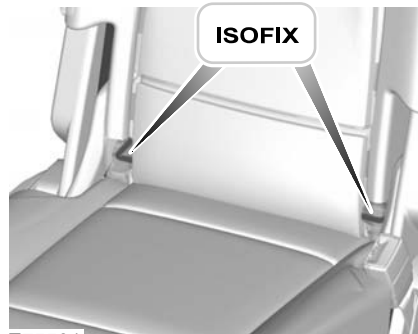

E75531

3. Push the child seat back firmly to engage the ISOFIX lower anchor points.
4. Tighten the tether strap in line with the child seat manufacturer's instructions.

Child safety

CHILD SAFETY LOCKS

WARNING



You cannot open the doors from inside if you have put the child safety locks on.

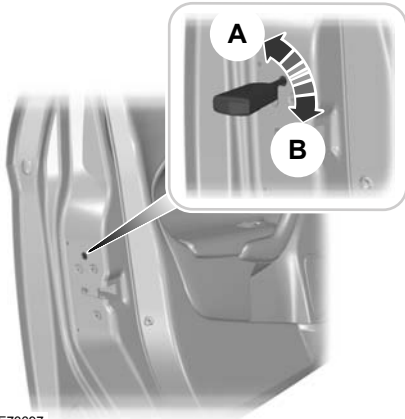

E73697

- A Lock
- B Unlock

Occupant protection

PRINCIPLE OF OPERATION

Airbags

WARNINGS



Do not modify the front of your vehicle in any way. This could adversely affect deployment of the airbags.



Original text according to ECE R94.01: Extreme Hazard! Do not use a rearward facing child restraint on a seat protected by an airbag in front of it!



Wear a seat belt and keep sufficient distance between yourself and the steering wheel. Only when you use the seat belt properly, can it hold you in a position that allows the airbag to achieve its optimum effect. See **Sitting in the correct position** (page 118).



Have repairs to the steering wheel, steering column, seats, airbags and seat belts carried out by a properly trained technician.



Keep the areas in front of the airbags free from obstruction. Do not affix anything to or over the airbag covers.



Do not poke sharp objects into areas where airbags are fitted. This could damage and adversely affect deployment of the airbags.



Use seat covers designed for seats with side airbags. Have these fitted by a properly trained technician.

Note: You will hear a loud bang and see a cloud of harmless powdery residue if an airbag deploys. This is normal.

Note: Only wipe airbag covers with a damp cloth.

Driver and front passenger airbags

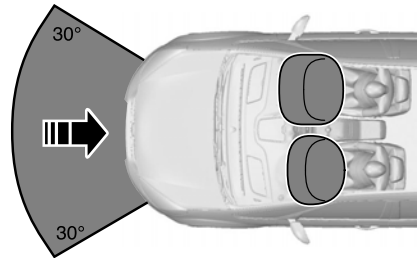

E74302

The driver and front passenger airbags will deploy during significant frontal collisions or collisions that are up to 30 degrees from the left or the right. The airbags will inflate within a few thousandths of a second and deflate on contact with the occupants, thus cushioning forward body movement. During minor frontal collisions, overturns, rear collisions and side collisions, the driver and front passenger airbags will not deploy.

Driver knee airbag

CAUTION



Do not attempt to open the driver knee airbag cover.

The driver knee airbag will deploy during frontal collisions or collisions that are up to 30 degrees from the left or the right. The airbag will inflate within a few thousandths of a second and deflate on contact with the occupants, thus providing a cushion between the driver's knees and the steering column. During overturns, rear collisions and side collisions, the knee airbag will not deploy.

Occupant protection

For item location: See **Quick start** (page 11).

Note: *The knee airbag has a lower deployment threshold than the front airbags. During a minor collision, it is possible that only the knee airbag deploys.*

Side airbags



E72658

Side airbags are fitted inside the seatback of the front seats. A label indicates that side airbags are fitted to your vehicle.

The side airbags will deploy during significant lateral collisions. The airbags will inflate within a few thousandths of a second and deflate on contact with the occupants, thus providing protection for the chest and shoulder areas. During minor lateral collisions, overturns, front collisions and rear collisions, the side airbags will not deploy.

Curtain airbags

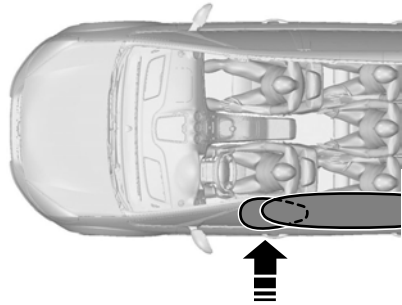

E75004

Curtain airbags are fitted inside the trim panels over the front and rear side windows. Moulded badges in the B-pillar trim panels indicate that curtain airbags are fitted to your vehicle.

The curtain airbags will deploy during significant lateral collisions. The airbag will inflate within a few thousandths of a second and deflate on contact with the occupants, thus providing protection for the head. During minor lateral collisions, front collisions, rear collisions, or overturns the curtain airbags will not deploy.

Seat belts

WARNINGS



 Wear a seat belt and keep sufficient distance between yourself and the steering wheel. Only when you use the seat belt properly, can it hold you in a position to achieve its optimum effect. See **Sitting in the correct position** (page 118).

 Never use a seat belt for more than one person.

 Use the correct buckle for each seat belt.

Occupant protection

WARNINGS

-  Do not use a seat belt that is slack or twisted.
-  Do not wear thick clothing. The seat belt must fit tightly around your body to achieve its optimum effect.
-  Position the shoulder strap of the seat belt over the centre of your shoulder and position the lap strap tightly across your hips.

The driver and front passenger seat belt retractors are fitted with a seat belt pretensioner. Seat belt pretensioners have a lower deployment threshold than the airbags. During minor collisions, it is possible that only the seat belt pretensioners will deploy.

FASTENING THE SEAT BELTS

WARNING

-  Insert the tongue into the buckle until you hear a distinct click. You have not fastened the seat belt properly if you do not hear a click.

Note: *The seat belt tongues are designed so that you can only insert them into the correct buckle.*



E74124

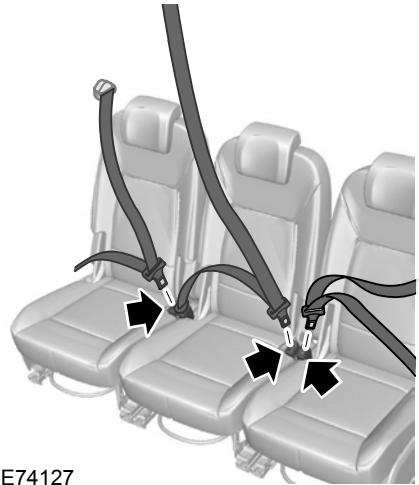

E74127

Pull the belt out steadily. It may lock if you pull it sharply or if the vehicle is on a slope.

Press the red button on the buckle to release the belt. Let it retract completely and smoothly.

Occupant protection

Second row centre seat belt

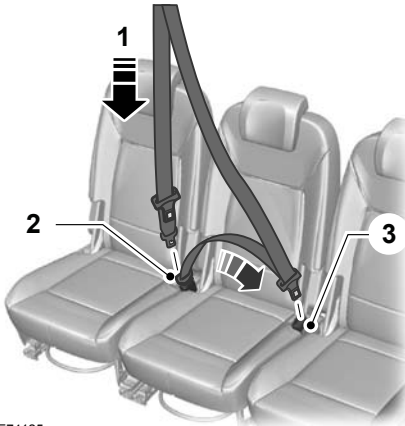

E74125

The retractor for the rear centre seat belt is located in the roof.

To fasten the seat belt:

1. Pull the belt out steadily. It may lock if you pull it sharply or if the vehicle is on a slope.
2. Insert the smaller tongue into the black buckle to the right of the centre seat (1).
3. Pull the larger tongue across the lap and insert it into the buckle to the left of the centre seat (2).
4. Press the red button on the left buckle to release the belt. Let it retract.

Note: *If in constant use, you can leave the belt buckled in the black buckle. When it is not in use, or when you fold or move the rear seats, you should release the belt from the black buckle.*

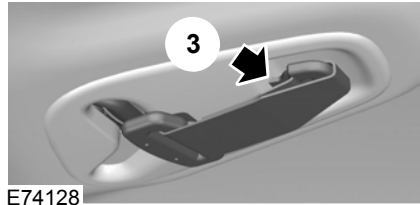

E74128

1. Press the button on the side of the black buckle to release the belt. Let it retract completely and smoothly to the retractor in the roof.
2. Insert the larger tongue into the pocket near the end of the seat belt.
3. Fold the smaller tongue back and insert it into the retaining slot (3).

SEAT BELT HEIGHT ADJUSTMENT



E73135

To raise the height, grasp the D-ring and move the pivot up.

To lower the height, grasp the D-ring, hold the locking button on the height adjuster pressed and move the pivot down.

Note: *Lifting the slider slightly while pressing the locking button makes it easier to release the locking mechanism.*

Occupant protection

SEAT BELT REMINDER

WARNING



The occupant protection system will only provide optimum protection when you use the seat belt properly.



The seat belt reminder warning lamp illuminates and an audible warning will sound if the driver's or front seat passenger's seat belt has not been fastened and the vehicle exceeds a relatively low speed. It will also illuminate if the driver's or front seat passenger's seat belt is unfastened when the vehicle is moving. The audible warning will go off after five minutes but the seat belt reminder warning lamp will remain on until the driver's or front seat passenger's seat belt is fastened.

Deactivating the seat belt reminder

See your dealer.

USING SEAT BELTS DURING PREGNANCY

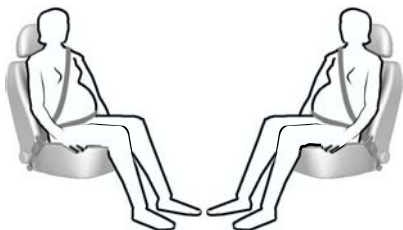

E68587

WARNING



Position the seat belt correctly for your safety and that of your unborn child. Do not use only the lap strap or the shoulder strap.

Position the lap strap comfortably across your hips and low beneath your pregnant abdomen. Position the shoulder strap between your breasts, above and to the side of your pregnant abdomen.

DISABLING THE PASSENGER AIRBAG

WARNING



Make sure that the passenger airbag is disabled when using a rearward facing child restraint on the front passenger seat.



E71313

Occupant protection

Fitting the passenger airbag deactivation switch

WARNING

 If you need to fit a child restraint on a seat protected by an operational airbag in front of it, have a passenger airbag deactivation switch fitted. Ask your dealer for further information.

Note: *The key switch is located in the glove compartment with an airbag deactivation lamp in the instrument panel.*

If the airbag warning lamp illuminates or flashes when you are driving, this indicates a malfunction. See **Warning lamps and indicators** (page 79). Remove the child restraint and have the system checked immediately.

Disabling the passenger airbag

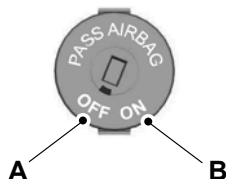

E71312

- A Disabled
- B Enabled

Turn the switch to position **A**.

When you switch the ignition on, check that the passenger airbag deactivation warning lamp illuminates.

Enabling the passenger airbag

WARNING

 Make sure that the passenger airbag is enabled when you are **not** using a child restraint on the front passenger seat.

Turn the switch to position **B**.

Keys and remote controls

GENERAL INFORMATION ON RADIO FREQUENCIES

CAUTION

 The radio frequency used by your remote control can also be used by other short distance radio transmissions (e.g. amateur radios, medical equipment, wireless headphones, remote controls and alarm systems). If the frequencies are jammed, you will not be able to use your remote control. You can lock and unlock the doors with the key.

Note: You could unlock the doors if you press the buttons on the remote control unintentionally.

The operating range between your remote control and your vehicle varies depending on the environment.

PROGRAMMING THE REMOTE CONTROL

You can programme a maximum of eight remote controls to use with your vehicle (including any supplied with your vehicle).

Programming a new remote control

1. Insert the key in the ignition.
2. Cycle the key from position **O** to **II** and then back to **O** four times in quick succession (about once a second).
3. Remove the key from the ignition and press any button on the remote control.
4. Reinsert the key and turn to position **II** then **O**. Remove the key and test the remote control to confirm programming has been successful.

Reprogramming the unlocking function

Note: When you press the unlock button either all the doors are unlocked or only the driver's door is unlocked. Pressing the unlock button again unlocks all the doors.

Press and hold the unlock and lock buttons on the remote key simultaneously for at least four seconds with the ignition off. The direction indicators will flash twice to confirm the change.

To return to the original unlocking function, repeat the process.

CHANGING THE REMOTE CONTROL BATTERY

Make sure that you dispose of old batteries in an environmentally friendly way. Seek advice from your local authority regarding recycling.

Remote control with a folding key blade

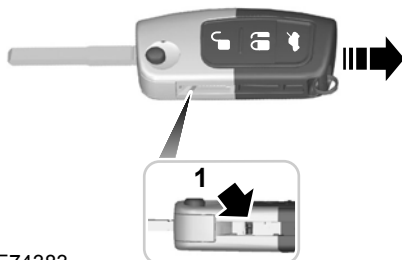

E74383

1. Insert a screwdriver as far as possible into the slot on the side of the remote control, push it towards the key blade and remove the key blade.

Keys and remote controls



E74384

2. Twist the screwdriver in the position shown to start separating the two halves of the remote control.



E74385

3. Twist the screwdriver in the position shown to separate the two halves of the remote control.

CAUTION

⚠ Do not touch the battery contacts or the printed circuit board with the screwdriver.

4. Carefully prise out the battery with the screwdriver.
5. Install a new battery (3V CR 2032) with the + facing downwards.
6. Assemble the two halves of the remote control.
7. Install the key blade.

Remote control without a folding key blade

Type 1

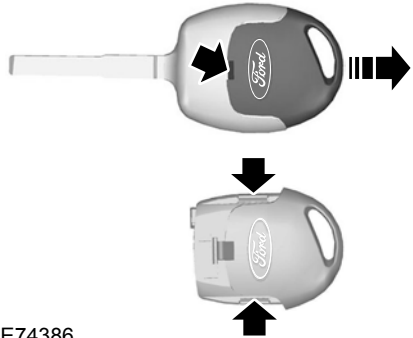

E74386

1. Insert a screwdriver into the recess on the back of the key and remove the key blade.
2. Release the retaining clips with the screwdriver and separate the two halves of the remote control.

CAUTION

⚠ Do not touch the battery contacts or the printed circuit board with the screwdriver.

3. Carefully prise out the battery with the screwdriver.
4. Install a new battery (3V CR 2032) with the + facing upwards.
5. Assemble the two halves of the remote control.
6. Install the key blade.

Keys and remote controls

Type 2

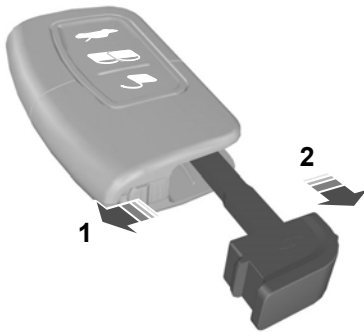

E78284

1. Slide the release slider in the direction of the arrow.
2. Remove the key blade.



E105064

3. Twist the screwdriver in the position shown to separate the two halves of the remote control.

CAUTION



Do not touch the battery contacts or the printed circuit board with the screwdriver.

4. Carefully prise out the battery with the screwdriver.
5. Install a new battery (3V CR 2032) with the + facing downwards.
6. Assemble the two halves of the remote control.
7. Install the key blade.

Type 3



E87964

1. Carefully remove the cover.
2. Remove the key blade.

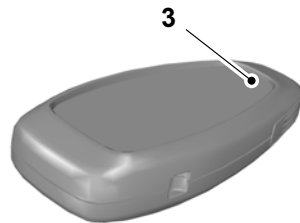

E105362

3. Twist the screwdriver in the position shown to separate the two halves of the remote control.

Keys and remote controls

CAUTION

 Do not touch the battery contacts or the printed circuit board with the screwdriver.

4. Carefully prise out the battery with the screwdriver.
5. Install a new battery (3V CR 2032) with the + facing downwards.
6. Assemble the two halves of the remote control.
7. Install the key blade.

Locks

LOCKING AND UNLOCKING

Central locking

You can only centrally lock the doors if they are all closed.

Note: The driver's door can be unlocked with the key. This needs to be used if the remote control is not functioning.

Note: Central locking also locks and unlocks the fuel filler flap.

Double locking

WARNING



Do not activate double locking when persons or animals are inside the vehicle. You will not be able to unlock the doors from the inside if you have double locked them.



E71961

Double locking is a theft protection feature that prevents someone from opening the doors from the inside. You can only double lock the doors if they are all closed.

Locking and unlocking confirmation

When you unlock the doors, the direction indicators will flash once.

When you lock the doors, the direction indicators will flash twice.

Note: The direction indicators will flash twice as soon as you activate central locking. They will not flash again when you press the lock button on the remote control or turn the key for the second time, i.e. when you activate double locking.

Locking and unlocking the doors with the key

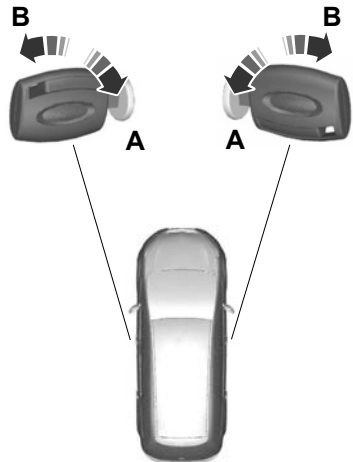

E71962

- A Unlock
- B Lock

Double locking the doors with the key

Turn the key to the lock position twice within three seconds to double lock the doors.

Locks

Locking and unlocking the doors and the luggage compartment lid with the remote control

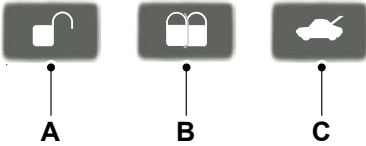

E87379

- A Unlock
- B Lock
- C Luggage compartment lid unlock

Locking the doors and the luggage compartment lid with the remote control

Press button **B** once.

Double locking the doors and the luggage compartment lid with the remote control

Press button **B** twice within three seconds.

Locking and unlocking the doors from inside

Driver's door

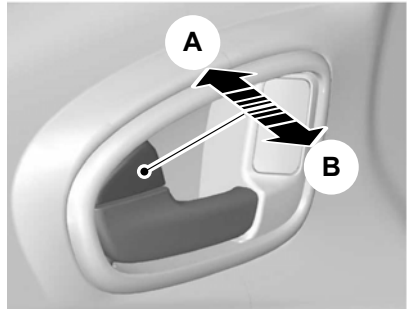

E71958

- A Lock all doors
- B Unlock all doors

Front and rear passenger doors



E98653

To lock the front and rear passenger doors individually, press the button and close the door when leaving the vehicle.

Locks

Luggage compartment lid

Opening the luggage compartment lid

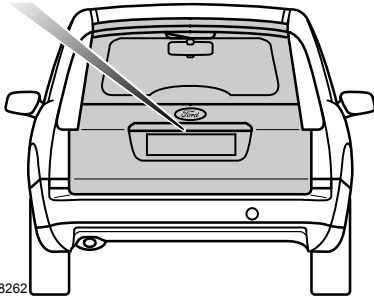
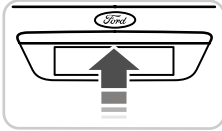

E78262

Opening the luggage compartment lid with the remote control

Press button **C** on the remote control twice within three seconds.

Closing the luggage compartment lid

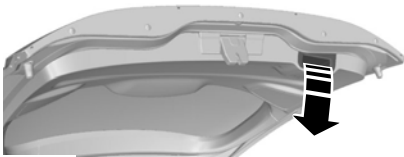

E71960

A recessed grip is incorporated inside the luggage compartment lid to facilitate closing.

Automatic relocking

The doors will relock automatically if you do not open a door within 45 seconds of unlocking the doors with the remote control. The door locks and the alarm will return to their previous state.

Reprogramming the unlocking function

The unlocking function may be reprogrammed so that only the driver's door is unlocked. See **Programming the remote control** (page 33).

GLOBAL OPENING AND CLOSING

You can also operate the electric windows with the ignition off via the global opening and global closing function.

Note: *Global closing will only operate if you have set the memory correctly for each window. See **Electric windows** (page 71).*

Global opening

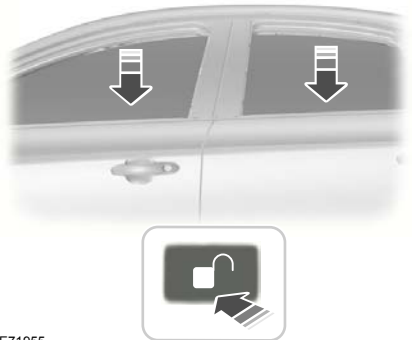

E71955

Locks

To open all the windows, press and hold the **unlock** button for at least three seconds. Press either the **lock** or the **unlock** button again to stop the opening function.

Global closing

Vehicles without keyless entry

WARNING



Take care when using global closing. In an emergency, press a button immediately to stop.

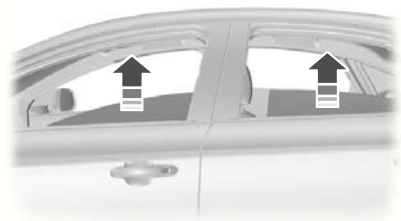

E71956

To close all the windows, press and hold the **lock** button for at least three seconds. Press any button again to stop the closing function. The anti-trap function is also active during global closing.

Vehicles with keyless entry

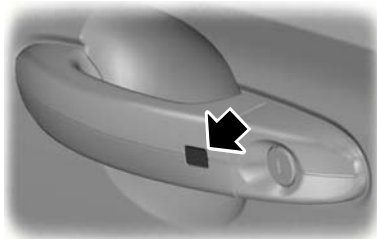

E87384

WARNING



Take care when using global closing. In an emergency, press the button on the driver's door handle to stop.

Note: *Global closing can be activated using the button on the driver's door handle. Global opening and closing can also be activated using the buttons on the passive key.*

To close all the windows, press and hold the button on the driver's door handle for at least two seconds. The anti-trap function is also active during global closing.

Engine immobiliser

PRINCIPLE OF OPERATION

The engine immobiliser is a theft protection system that prevents someone from starting the engine with an incorrectly coded key.

If you are unable to start the engine with a correctly coded key, this indicates a malfunction. The message **Immobiliser active** will appear in the information display when you switch on the ignition. Have the immobiliser checked immediately.

CODED KEYS

Note: *Do not shield your keys with metal objects. This may prevent the receiver from recognising your key as a valid one.*

Note: *Have all of your remaining keys erased and recoded if you lose a key. Ask your dealer for further information. Have replacement keys recoded together with your existing keys.*

If you lose a key, you can obtain a replacement from your Ford Dealer. If possible, provide them with the key number from the tag provided with the original keys. You can also obtain additional keys from your Ford Dealer.

ARMING THE ENGINE IMMOBILISER

The engine immobiliser is armed automatically a short time after you have switched the ignition off.

DISARMING THE ENGINE IMMOBILISER

The engine immobiliser is disarmed automatically when you switch the ignition on with a correctly coded key.

If the message **Immobiliser active** appears in the information display, your key has not been recognised. Remove the key and try again.

Alarm

PRINCIPLE OF OPERATION

Alarm system

Your vehicle may be equipped with one of the following alarm systems:

- Perimeter alarm.
- Perimeter alarm with interior sensors.
- Category one alarm with interior sensors and battery back-up sounder.
- Category one alarm with interior sensors, battery back-up sounder and tilt sensors.

Perimeter alarm

The perimeter alarm is a deterrent against unauthorised access to your vehicle through the doors and the bonnet. It also protects the audio unit.

Interior sensors



E71401

WARNING



The sensors in the interior lamp unit must not be covered up. Do not activate the alarm with full guard if any persons, animals or other moving objects are inside the vehicle.

The sensors act as a deterrent against unauthorised intrusion by sensing any movement within the vehicle.

Battery back-up sounder

The battery back-up sounder is an extra alarm system which will sound a siren when the alarm is triggered. It is armed directly when you lock the vehicle. The sounder has its own battery and will sound an alarm siren even if someone disconnects the vehicle battery or the battery back-up sounder itself.

Tilt sensors

The tilt sensors detect if someone attempts to steal a wheel or tow the vehicle away by sensing changes in the inclination of the vehicle.

Note: *When travelling on a ferry with the alarm armed, deactivate the tilt sensors by selecting reduced guard. This will prevent the alarm from being triggered by the movement.*

Triggering the alarm

Once armed, the alarm is triggered in any of the following ways:

- If someone opens a door, the tailgate or the bonnet without a valid key or remote control.
- If someone removes the audio or navigation system.
- If the ignition is turned to position I, II or III without a valid key.
- If the interior sensors detect movement within the vehicle.
- On vehicles with a battery back-up sounder, if someone disconnects the vehicle battery or the battery back-up sounder itself.
- If the tilt sensors detect a change in the inclination of the vehicle.

If the alarm is triggered, the alarm horn will sound for 30 seconds and the hazard warning flasher will flash for five minutes.

Alarm

Any further attempts to perform one of the above will trigger the alarm again.

Full and reduced guard

Full guard

Full guard is the standard setting.

In full guard, the interior and tilt sensors are activated when you arm the alarm.

Note: *This may result in false alarms if animals or moving objects are inside the vehicle or, on vehicles with tilt sensors, when travelling on a ferry.*

Reduced guard

In reduced guard, the interior and tilt sensors are deactivated when you arm the alarm.

Note: *You can set the alarm to reduced guard for the current ignition cycle only. The next time you switch on the ignition, the alarm will be reset to full guard.*

Ask on Exit

You can set the information display to ask you each time which level of guard you wish to set.

If you select **Ask on Exit**, the message **Reduced guard?** appears in the instrument cluster display each time you switch the ignition off.

If you wish to arm the alarm with reduced guard, press the **OK** button when this message appears.

If you wish to arm the alarm with full guard, leave the vehicle without pressing the **OK** button.

Selecting full or reduced guard

Note: *Selecting **Reduced** does not set the alarm permanently to reduced guard. It sets it to reduced guard only for the current ignition cycle. If you regularly set the alarm to reduced guard, select **Ask on Exit**.*

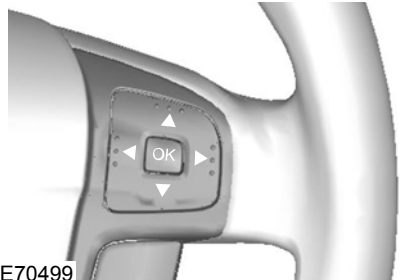

E70499

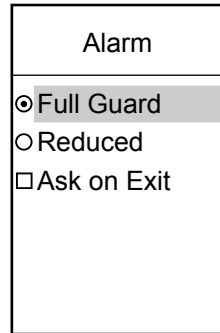

E74509

1. Press the right arrow button on the steering wheel to enter the main menu.
2. Highlight **Setup** with the up and down arrow buttons and press the right arrow button.
3. Highlight **Alarm** and press the right arrow button.

Alarm

4. Highlight **Reduced** or **Full guard**. If you prefer to be asked each time you switch off the ignition, select **Ask on Exit**.
5. Press the **OK** button to confirm the selection.
6. Press the left arrow button to exit the menu. To return to the trip computer display directly, hold the left arrow button pressed.

Information messages

See **Information messages** (page 95).

ARMING THE ALARM

All vehicles

To arm the alarm, lock the vehicle with the key or remote control.

DISARMING THE ALARM

Perimeter alarm

Disarm and silence the alarm by unlocking the doors with the key, switching the ignition on with a correctly coded key or unlocking the doors with the remote control. See **Locking and unlocking** (page 37).

Category one alarm

Disarm and silence the alarm by unlocking the doors with the key in the driver's door and switching the ignition on with a correctly coded key within 12 seconds or unlocking the doors with the remote control. See **Locking and unlocking** (page 37).

Steering wheel

ADJUSTING THE STEERING WHEEL

WARNING

 Never adjust the steering wheel when the vehicle is moving.

Note: Make sure that you are sitting in the correct position. See **Sitting in the correct position** (page 118).

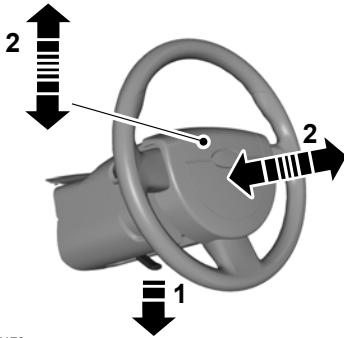

E95178

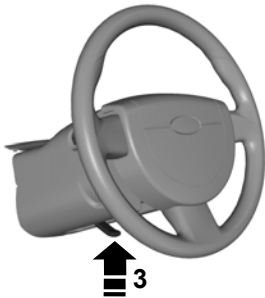

E95179

WARNING

 Make sure that you fully engage the locking lever when returning it to its original position.

AUDIO CONTROL

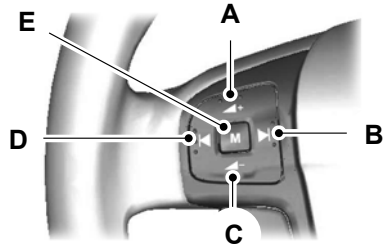

E72288

- A Volume up
- B Seek up
- C Volume down
- D Seek down
- E Mode

Mode

Press and **hold** the mode button to select the audio source.

Press the mode button to:

- tune the radio to the next preset station
- play the next CD
- play the other side of a cassette tape
- accept an incoming telephone call.
- end a telephone call.

Steering wheel

Seek

Press a seek button to:

- tune the radio to the next station up or down the frequency band
- play the next or the previous CD track
- fast forward or rewind the cassette tape.

Press and **hold** a seek button to:

- tune the radio up or down the frequency band
- seek through a CD track.

Wipers and washers

WINDSCREEN WIPERS

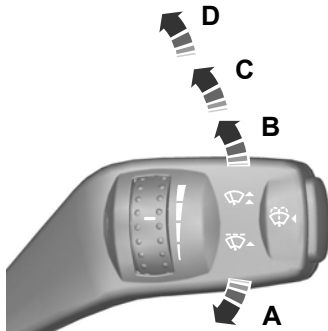

E70696

- A Single wipe
- B Intermittent wipe
- C Normal wipe
- D High speed wipe

Intermittent wipe

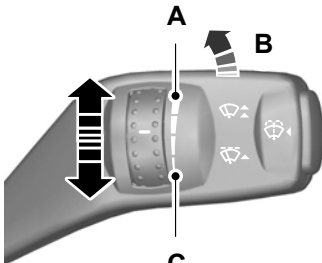

E70315

- A Short wipe interval
- B Intermittent wipe
- C Long wipe interval

AUTOWIPERS

CAUTIONS

- ⚠ Do not switch autowipers on in dry weather conditions. The rain sensor is very sensitive and the wipers may operate if dirt, mist or flies hit the windscreen.
- ⚠ Replace the wiper blades as soon as they begin to leave bands of water and smears. If you do not replace them, the rain sensor will continue to detect water on the windscreen and the wipers will operate, even though the majority of the windscreen is dry.
- ⚠ Fully defrost the windscreen in icy conditions before you switch autowipers on.
- ⚠ Switch autowipers off before you enter a car wash.

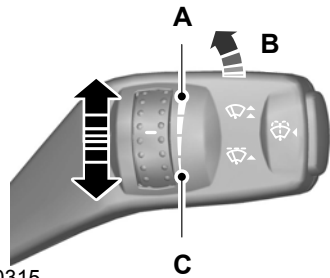

E70315

- A High sensitivity
- B On
- C Low sensitivity

Wipers and washers

If you switch autowipers on, the wipers will not cycle until water is detected on the windscreen. The rain sensor will then continuously measure the amount of water on the windscreen and adjust the speed of the wipers automatically.

Adjust the sensitivity of the rain sensor using the rotary control. With low sensitivity, the wipers will operate when the sensor detects a lot of water on the windscreen. With high sensitivity, the wipers will operate if the sensor detects a small amount of water on the windscreen.

WINDSCREEN WASHERS

WARNING



Do not operate the windscreen washers for more than 10 seconds or when the reservoir is empty.

Note: The washer jets are heated when the ignition is on.

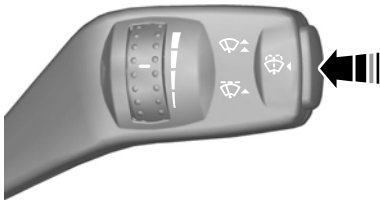

E70776

REAR WINDOW WIPER AND WASHERS

Intermittent wipe

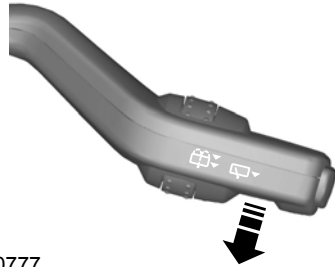

E70777

Reverse gear wipe

The rear window wiper will operate automatically when you select reverse gear if the wiper lever is in position **B**, **C** or **D**.

Washer

WARNING



Do not operate the rear window washer for more than 10 seconds or when the reservoir is empty.

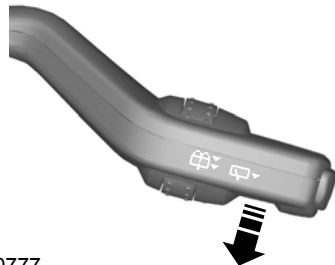

E70777

Pull the lever fully towards the steering wheel and hold it to operate the washer.

Wipers and washers

HEADLAMP WASHERS

The headlamp washers will operate with the windscreen washers when the headlamps are on.

Note: To stop the washer fluid reservoir emptying quickly, the headlamp washers will not operate every time that you use the windscreen washers.

CHECKING THE WIPER BLADES

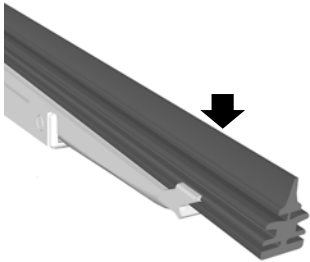

E66644

Run the tip of your fingers over the edge of the blade to check for roughness.

Clean the wiper blade lips with water applied with a soft sponge.

CHANGING THE WIPER BLADES

Windscreen wiper blades

CAUTIONS

! Set the windscreen wipers in the service position to change the wiper blades.

CAUTIONS

! You can use the service position in winter to provide easier access to the wiper blades for freeing them from snow and ice. The windscreen wipers will return to their normal position as soon as you switch on the ignition so make sure that you fully defrost the windscreen before you switch on the ignition.

Note: The windscreen wiper blades are different lengths. See **Technical specifications** (page 51). If you install wiper blades of the wrong length, the rain sensor may not work correctly.

Set the windscreen wipers in the service position.



E75184

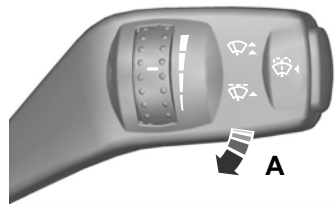

E75188

Switch off the ignition and move the wiper lever to position **A** within three seconds. Release the lever when the windscreen wipers have moved to the service position.

Wipers and washers

Lift the wiper arms.

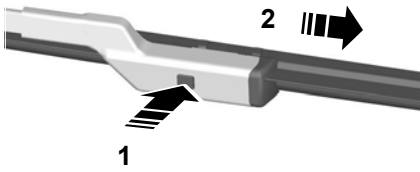

E72899

Install in the reverse order.

Note: Make sure that the wiper blade locks into place.

Rear window wiper blades

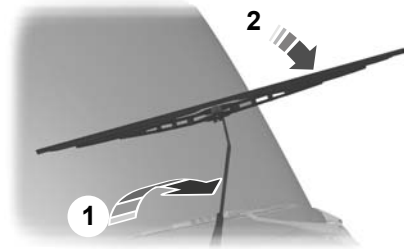

E93783

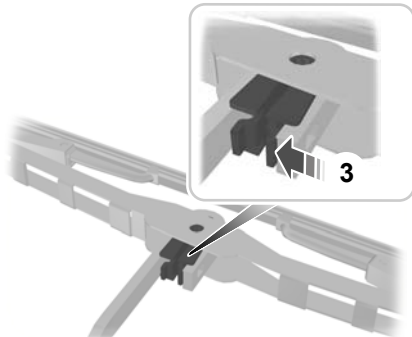

E93784

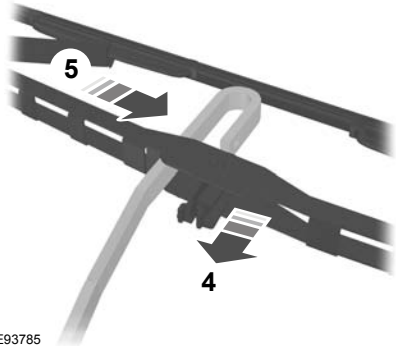

E93785

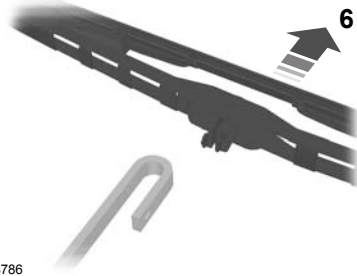

E93786

Install in the reverse order.

Wipers and washers

TECHNICAL SPECIFICATIONS

Windscreen wiper blade lengths

| Item | Dimension in mm (inches) | |
|-----------------------------|--------------------------|------------|
| | Left-hand | Right-hand |
| Vehicles with autowipers | 750 (29.5) | 700 (27.6) |
| Vehicles without autowipers | 750 (29.5) | 650 (25.6) |

Lighting

LIGHTING CONTROL

Lighting control positions

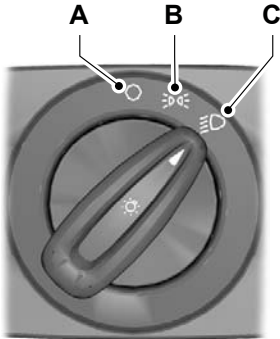

E70718

- A Off
- B Side and tail lamps
- C Headlamps

Parking lamps

CAUTION

 Prolonged use of the parking lamps will discharge the battery.

Switch off the ignition.

Both sides

Set the lighting control to position **B**.

One side

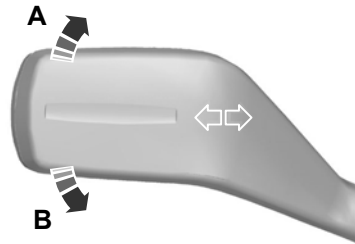

E75505

- A Right-hand side
- B Left-hand side

Main and dipped beam

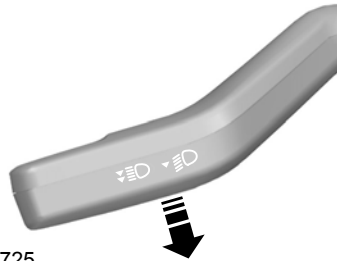

E70725

Pull the lever fully towards the steering wheel to switch between main and dipped beam.

Headlamp flasher

Pull the lever slightly towards the steering wheel.

Lighting

Home safe lighting

Switch the ignition off and pull the direction indicator lever towards the steering wheel to switch the headlamps on. You will hear a short tone. The headlamps will go off automatically after three minutes with any door open, or 30 seconds after the last door has been closed.

With all doors closed, but within the 30 second delay, opening any door will result in the three minute timer starting again.

The home safe lights can be cancelled by either pulling the direction indicator lever towards the steering wheel again or by turning the ignition switch on.

AUTOLAMPS

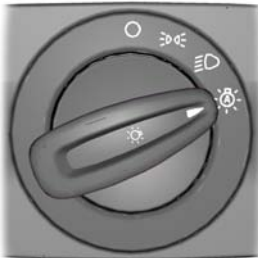

E70719

Note: If you have switched autolamps on, you can only switch the main beam on when autolamps has switched the headlamps on.

The headlamps will come on and go off automatically depending on the ambient light.

FRONT FOG LAMPS

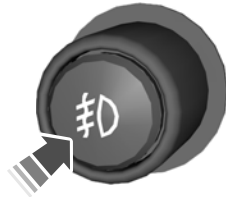

E70721

WARNING



Only use the front fog lamps when visibility is considerably restricted by fog, snow or rain.

REAR FOG LAMPS



E70720

WARNINGS



Only use the rear fog lamps when visibility is restricted to less than 50 metres.



Do not use the rear fog lamps when it is raining or snowing and visibility is more than 50 metres.

HEADLAMP LEVELLING

Note: Vehicles with Xenon headlamps are equipped with automatic headlamp levelling.

Lighting



- A Raised headlamp beams
- B Lowered headlamp beams

You can adjust the level of the headlamp beams according to the vehicle load.

E70722

Recommended headlamp levelling switch positions

| Load | | | Load in luggage compartment | Switch position |
|-------------|------------------|-----------------|-----------------------------|----------------------|
| Front seats | Second row seats | Third row seats | | |
| 1-2 | - | - | - | 0 |
| 1-2 | - | 2 | - | 0 (0.5) ² |
| 1-2 | 3 | - | - | 1 (0.5) ² |
| 1-2 | 3 | - | Max ¹ | 3 (0.5) ² |
| 1 | - | - | Max ¹ | 4 (1.5) ² |

¹ See **Vehicle identification plate** (page 238).

Lighting

² Vehicles with active suspension.

HAZARD WARNING FLASHERS



For item location: See **Quick start** (page 11).

Note: Depending on applicable laws and regulations in the country for which your vehicle was originally built, the hazard warning flashers may flash if you brake heavily.

ADAPTIVE FRONT LIGHTING SYSTEM (AFS)

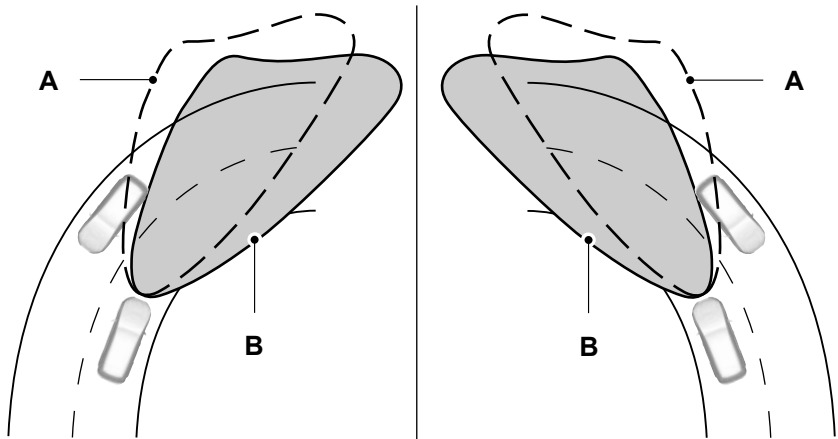

E72897

- A without AFS
- B with AFS

The AFS adjusts the headlamp dipped beam depending on vehicle direction and speed. It improves visibility when you are driving at night and helps to reduce headlamp glare for oncoming drivers.

The system will not operate when the vehicle is stationary, when you have switched on the daytime running lamps or when you have selected reverse gear.

Lighting

A message will appear in the information display if the system malfunctions. See **Information messages** (page 95). The headlamps will move to a fixed central or dipped position. Have the system checked as soon as possible.

Cornering lamps

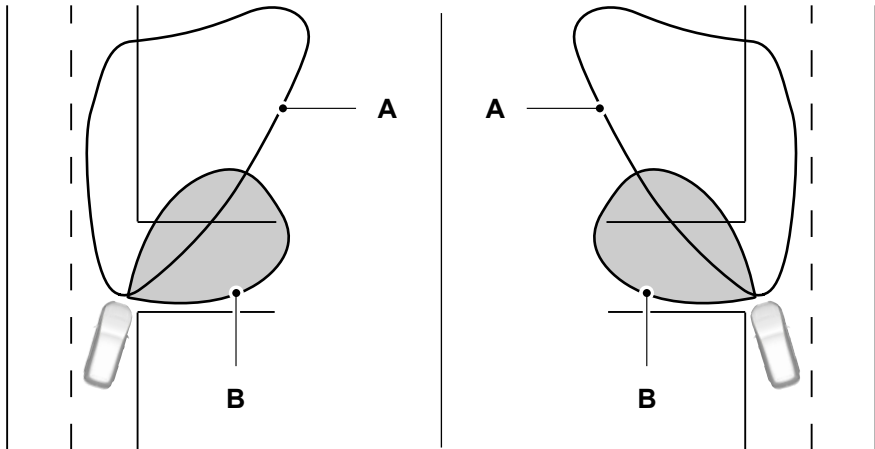

E72898

- A Headlamp beam
- B Cornering lamp beam

The cornering lamps illuminate the inside of a corner when you are turning.

Lighting

DIRECTION INDICATORS

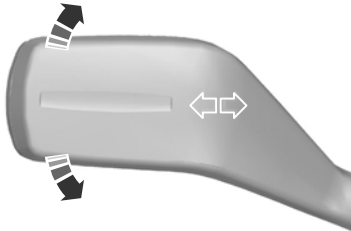

E70727

Note: Tap the lever up or down to make the direction indicators flash only three times.

INTERIOR LAMPS

Courtesy lamp

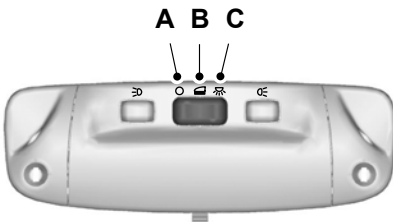

E71945

- A Off
- B Door contact
- C On

If you set the switch to position **B**, the courtesy lamp will come on when you unlock or open a door or the luggage compartment lid. If you leave a door open with the ignition switch off, the courtesy lamp will go off automatically after some time to prevent the vehicle battery from discharging. To switch it back on, switch on the ignition for a short time.

The courtesy lamp will also come on when you switch off the ignition. It will go off automatically after a short time or when you start or restart the engine.

If you set the switch to position **C** with the ignition switch off, the courtesy lamp will come on. It will go off automatically after a short time to prevent the vehicle battery from discharging. To switch it back on, switch on the ignition for a short time.

Reading lamps

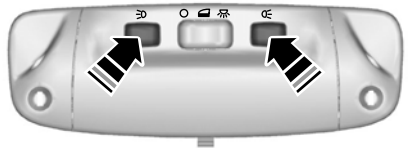

E71946

If you switch off the ignition, the reading lamps will go off automatically after some time to prevent the vehicle battery from discharging. To switch them back on, switch on the ignition for a short time.

Lighting

Vanity mirror lamps

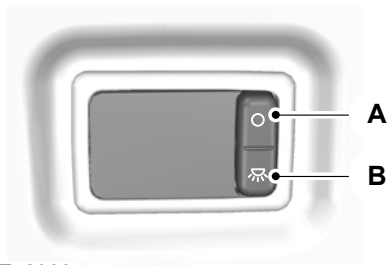

E72900

A Off

B On

If you switch off the ignition, the vanity mirror lamps will go off automatically after a short time to prevent the vehicle battery from discharging. To switch them back on, switch on the ignition for a short time.

REMOVING A HEADLAMP

WARNING



Have Xenon bulbs changed by a properly trained technician. There is a risk of electric shock.

1. Open the bonnet. See **Opening and closing the bonnet** (page 206).

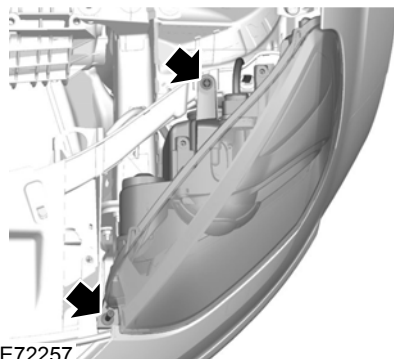

E72257

Note: When you remove the headlamp, make sure that the front screw remains in the headlamp moulding.

2. Remove the screws.

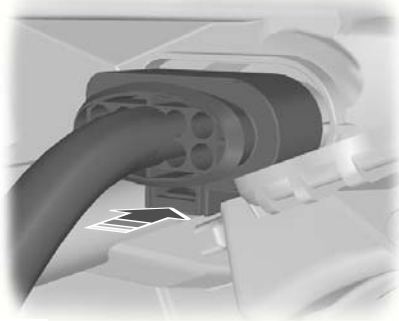

E88875

3. Disconnect the electrical connector.
4. Pull the headlamp as far as possible towards the centre of the vehicle and disengage it from the lower fixing point.
5. Lift the outer side of the headlamp and remove it.

Note: When fitting the headlamp, make sure that you reconnect the electrical connector properly.

Lighting

Note: When fitting the headlamp, make sure that you fully engage the headlamp in the lower fixing point.

Note: When fitting the headlamp, make sure that the front screw is located in the headlamp moulding before you install it.

Note: When fitting the headlamp, tighten the front screw first and then the rear screw.

CHANGING A BULB

WARNINGS



Switch the lights and the ignition off.



Let the bulb cool down before removing it.



Have Xenon bulbs changed by a properly trained technician. There is a risk of electric shock.

CAUTIONS



Do not touch the glass of the bulb.



Only fit bulbs of the correct specification. See **Bulb specification chart** (page 69).

Note: The following instructions describe how to remove the bulbs. Fit replacements in the reverse order unless otherwise stated.

Headlamp

Note: Remove the covers to gain access to the bulbs.

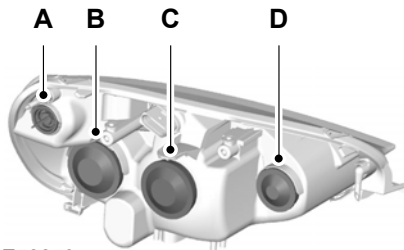

E72258

- A Direction indicator
- B Headlamp main beam
- C Headlamp dipped beam
- D Cornering lamp

Direction indicator

1. Remove the headlamp. See **Removing a headlamp** (page 58).

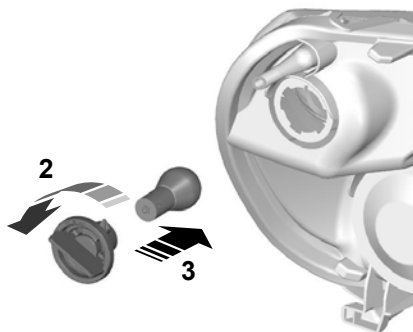

E72259

2. Turn the bulb holder anti-clockwise and remove it.
3. Gently press the bulb into the bulb holder, turn it anti-clockwise and remove it.

Lighting

Headlamp main beam

1. Remove the headlamp. See **Removing a headlamp** (page 58).

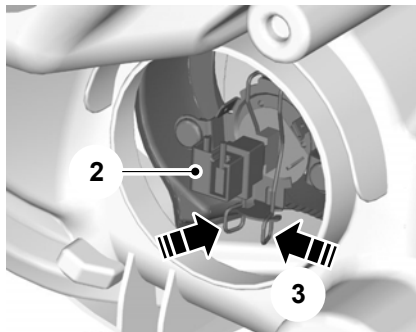

E72261

2. Disconnect the electrical connector.
3. Release the clip and remove the bulb.

Headlamp dipped beam

1. Remove the headlamp. See **Removing a headlamp** (page 58).

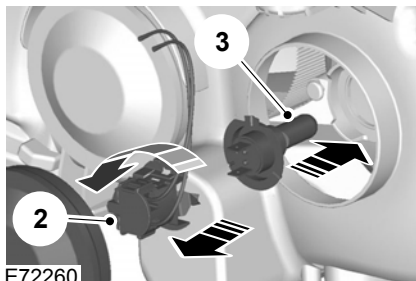

E72260

2. Turn the bulb holder anti-clockwise and remove it.
3. Remove the bulb.

Cornering lamp

1. Remove the headlamp. See **Removing a headlamp** (page 58).

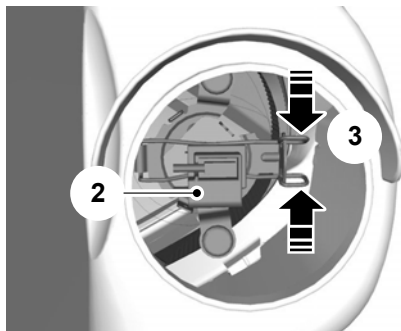

E72262

2. Disconnect the electrical connector.
3. Release the clip and remove the bulb.

Side repeater

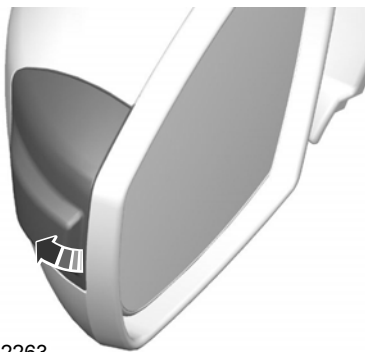

E72263

1. Carefully remove the side repeater.

Lighting

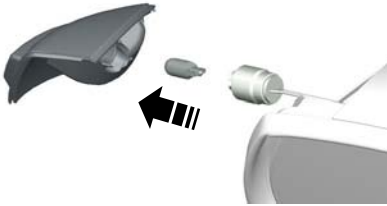

E72291

2. Remove the bulb holder.
3. Remove the bulb.

Approach lamp

Note: Position the mirror glass as far inwards as possible.



E72264

1. Insert a screwdriver into the gap between the mirror housing and the mirror glass and release the metal retaining clip.

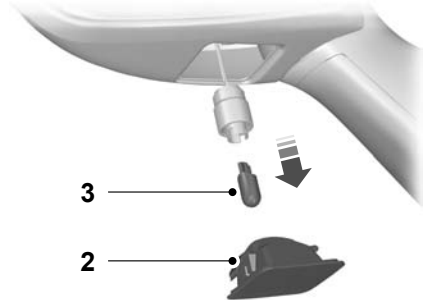

E72265

2. Remove the lamp.
3. Remove the bulb.

Front fog lamp and side lamp (S-MAX)

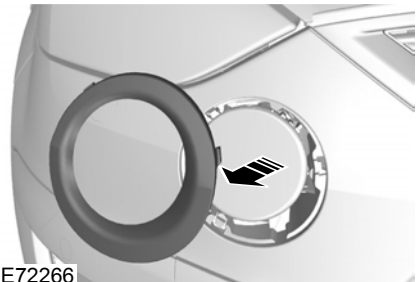

E72266

1. Remove the trim.

Lighting

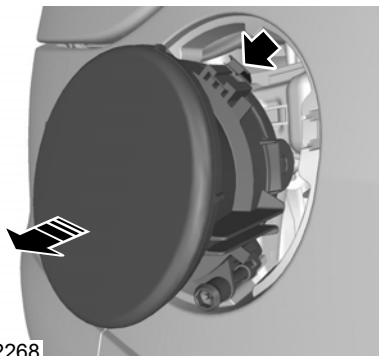

E72268

2. Release the clip at the top edge of the lamp using a screwdriver.
3. Remove the lamp.

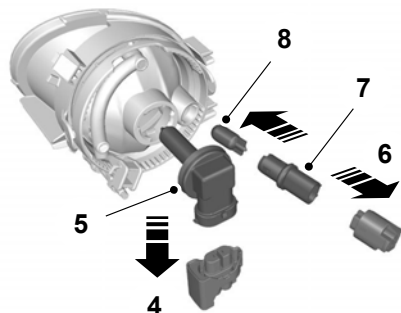

E74542

4. Disconnect the electrical connector.
- Note:** You cannot separate the fog lamp bulb from the bulb holder.
5. Turn the fog lamp bulb holder anti-clockwise and remove it.
 6. Disconnect the electrical connector.
 7. Turn the side lamp bulb holder anti-clockwise and remove it.
 8. Remove the side lamp bulb.

Front fog lamp and side lamp (Galaxy)

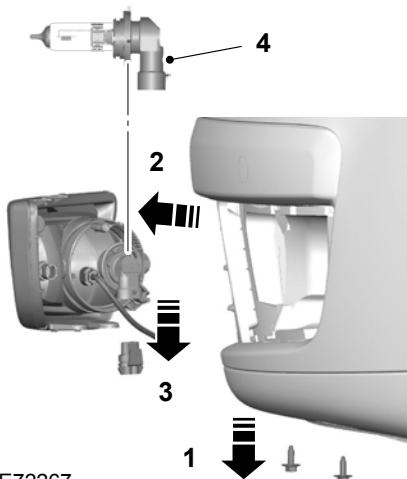

E72267

1. Remove the screws.
2. Remove the lamp.
3. Disconnect the fog lamp electrical connector.

Note: You cannot separate the fog lamp bulb from the bulb holder.

4. Turn the fog lamp bulb holder anti-clockwise and remove it.

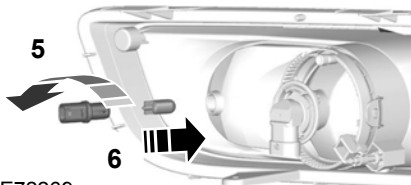

E72269

5. Turn the side lamp bulb holder anti-clockwise and remove it.

Lighting

6. Remove the side lamp bulb.

Rear lamp (S-MAX)

Direction indicator and brake and tail lamp

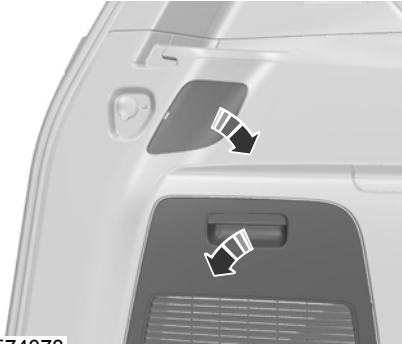

E74078

1. Remove the trim panels.

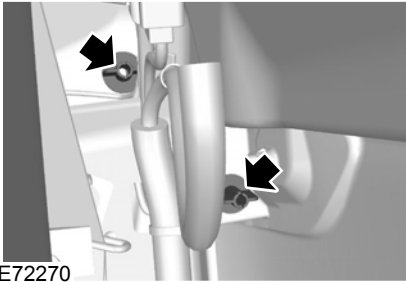

E72270

2. Remove the wing nuts.

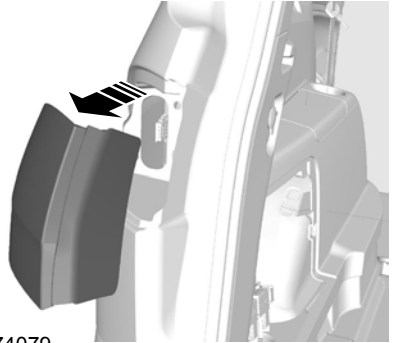

E74079

3. Remove the lamp.

4. Disconnect the electrical connector.

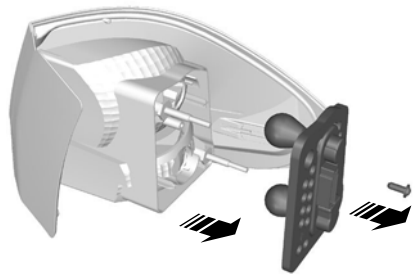

E74080

5. Remove the screw.

6. Remove the bulb holder.

7. Gently press the bulb into the bulb holder, turn it anti-clockwise and remove it.

Lighting

Reversing lamp, fog lamp and tail lamp

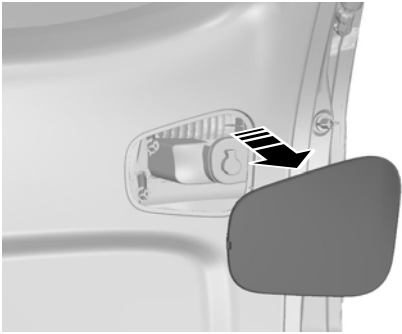

E72271

1. Remove the trim panel.

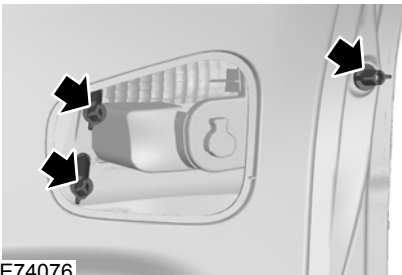

E74076

2. Remove the wing nuts.
3. Remove the lamp.
4. Disconnect the electrical connector.

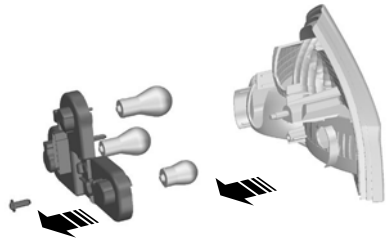

E74077

5. Remove the screw.
6. Remove the bulb holder.
7. Gently press the bulb into the bulb holder, turn it anti-clockwise and remove it.

Rear lamp (Galaxy)

Direction indicator, brake lamp and tail lamp

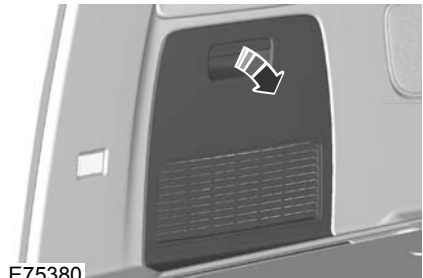

E75380

1. Remove the trim panel.

Lighting

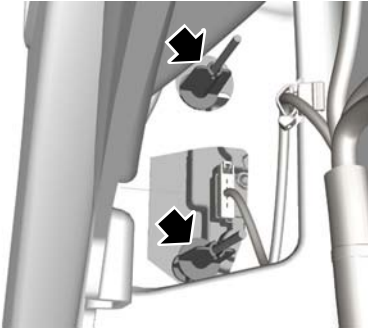

E72791

2. Remove the wing nuts.

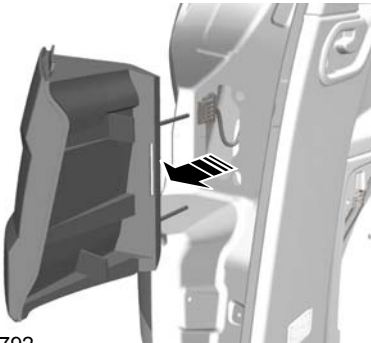

E72792

3. Remove the lamp.
4. Disconnect the electrical connector.

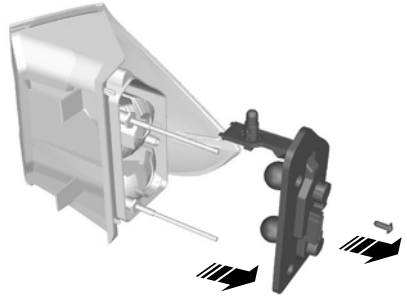

E72793

5. Remove the screw.
6. Remove the bulb holder.
7. Gently press the bulb into the bulb holder, turn it anti-clockwise and remove it.

Reversing lamp, fog lamp and tail lamp

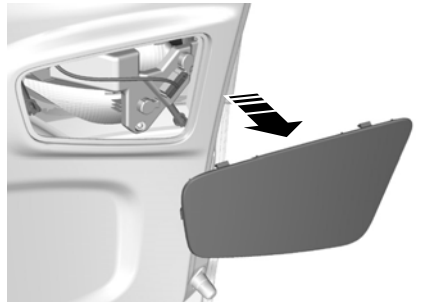

E72794

1. Remove the trim panel.

Lighting

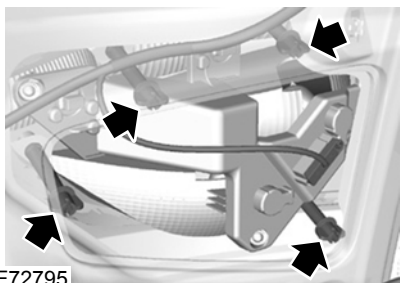

E72795

2. Remove the wing nuts.
3. Remove the lamp.
4. Disconnect the electrical connector.

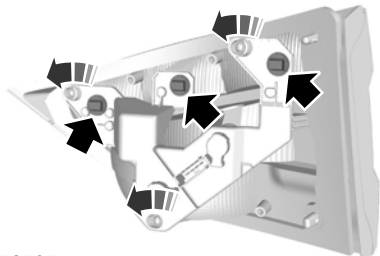

E72797

5. Turn the bulb holder anti-clockwise and remove it.

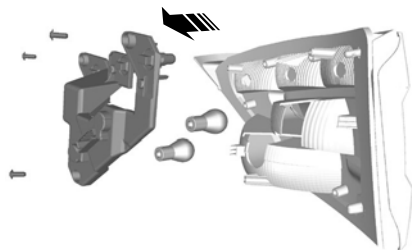

E72798

6. Remove the screws.
7. Remove the bulb holder.

8. Gently press the bulb into the bulb holder, turn it anti-clockwise and remove it.

Central high mounted brake lamp (S-MAX)

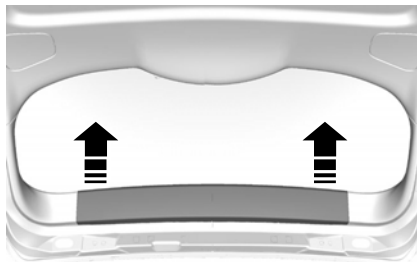

E75459

1. Remove the trim panel.

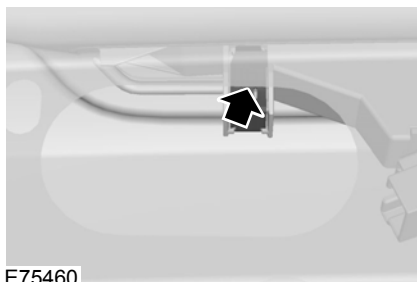

E75460

2. Release the spring clips.

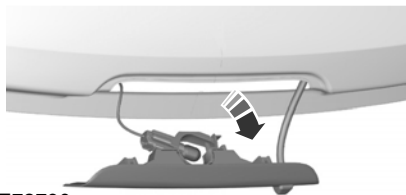

E72790

3. Remove the lamp.
4. Remove the bulb.

Lighting

Central high mounted brake lamp (Galaxy)

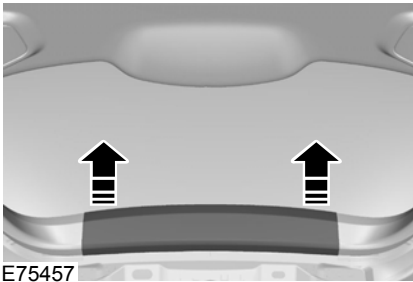

E75457

1. Remove the trim panel.

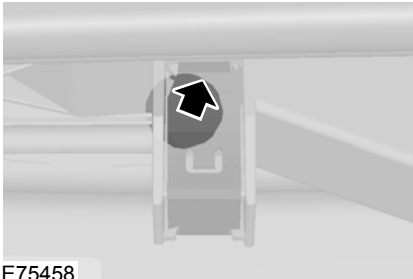

E75458

2. Release the spring clips.

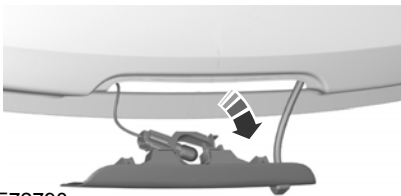

E72790

3. Remove the lamp.
4. Remove the bulb.

Number plate lamp

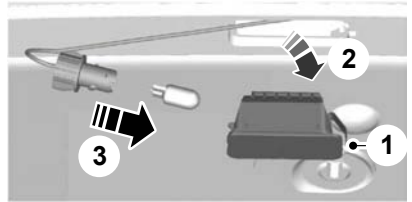

E72789

1. Carefully release the spring clip.
2. Remove the lamp.
3. Turn the bulb anti-clockwise and remove it.

Interior lamps

Vehicles without interior sensors

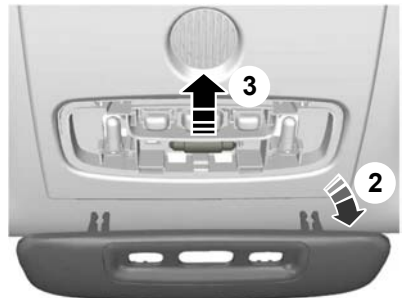

E72788

1. Carefully prise out the lens.
2. Remove the lens.
3. Remove the bulb.

Lighting

Vehicles with interior sensors

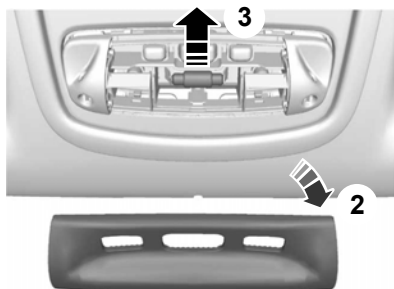

E72787

1. Carefully prise out the lens.
2. Remove the lens.
3. Remove the bulb.

Reading lamps

Vehicles without interior sensors

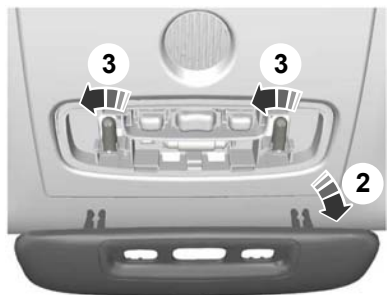

E72796

1. Carefully prise out the lens.
2. Remove the lens.
3. Remove the bulb.

Vehicles with interior sensors

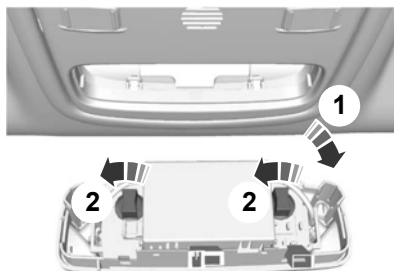

E72786

1. Carefully prise out the lamp.
2. Turn the bulb holder anti-clockwise and remove it.

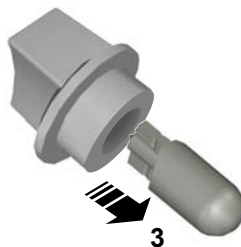

E73939

3. Remove the bulb.

Lighting

Vanity mirror lamp

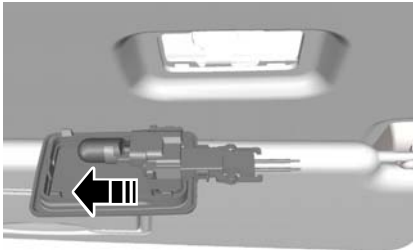

E72785

1. Carefully prise out the lamp.
2. Remove the bulb.

Luggage compartment lamp

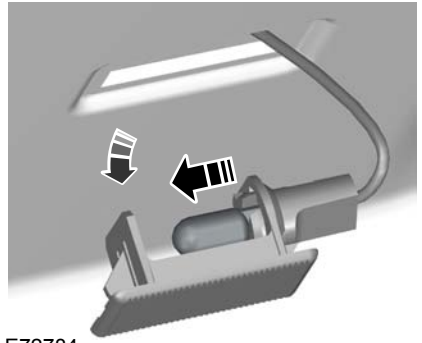

E72784

1. Carefully prise out the lamp.
2. Remove the bulb.

BULB SPECIFICATION CHART

| Lamp | Specification | Power (watt) |
|-----------------------------|---------------|--------------|
| Front direction indicator | PY21W | 21 |
| Headlamp main beam | H1 | 55 |
| Headlamp dipped beam | H7 | 55 |
| Cornering lamp | H1 | 55 |
| Side repeater | WY5W | 5 |
| Approach lamp | W5 | 5 |
| Front fog lamp (S-MAX) | H8 | 35 |
| Front fog lamp (Galaxy) | HB4 | 55 |
| Side lamp | W5W | 5 |
| Rear direction indicator | PY21W | 21 |
| Brake and tail lamp (S-MAX) | P21/5W | 21/5 |
| Brake lamp (Galaxy) | P21W | 21 |
| Tail lamp (Galaxy) | W5W | 5 |

Lighting

| Lamp | Specification | Power (watt) |
|---------------------------------|----------------------|---------------------|
| Rear fog lamp | P21W | 21 |
| Reversing lamp | P21W | 21 |
| Central high mounted brake lamp | W16W | 16 |
| Number plate lamp | C5W | 5 |
| Interior lamp | Festoon | 10 |
| Reading lamp | BA 9s | 5 |
| Vanity mirror lamp | W5W | 5 |
| Luggage compartment lamp | W5W | 5 |

Windows and mirrors

ELECTRIC WINDOWS

WARNING



Do not operate the electric windows unless they are free from obstruction.

Note: If you operate the switches often during a short period of time, the system might become inoperable for a certain time to prevent damage due to overheating.

Note: You can operate the windows for several minutes after you switch off the ignition. They will be deactivated as soon as a door is opened.

Note: If you operate both the switch on the relevant door and the switch for that window on the driver's door at the same time, the window will stop moving.

Switch on the ignition to operate the electric windows.

Global opening and global closing

You can also operate the electric windows with the ignition off via the global opening and global closing function. See **Global opening and closing** (page 39).

Note: Global opening and global closing will open or close the windows automatically only on vehicles equipped with four electric windows.

Note: Global closing will only operate if you have set the memory correctly for each window.

Driver's door switches

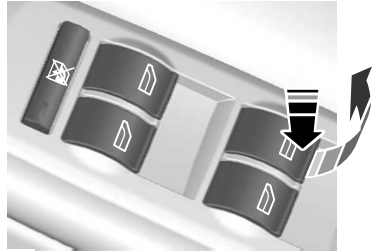

E70848

You can operate all the windows with the switches on the door trim panel of the driver's door.

Front and rear passengers' door switches

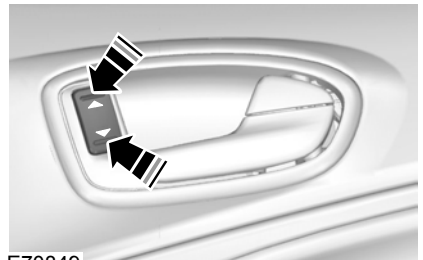

E70849

Opening and closing the windows automatically

Press or lift the switch to the second action point and release it. Press or lift it again to stop the windows.

Safety switch for rear windows

Note: You can always operate the rear windows from the driver's door.

Windows and mirrors

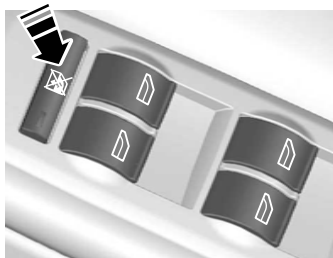

E70850

A switch in the driver's door disables the rear electric window switches.

The light in the switch illuminates and the lights in the rear window switches go off when the rear windows are disabled.

Anti-trap function

WARNING



Careless closing of the windows can override the protection function and cause injuries.

The electric windows will stop automatically while closing and reverse some distance if there is an obstacle in the way.

Overriding the anti-trap function

CAUTION



While you close the window for the third time, the anti-trap function is disabled. Make sure there are no obstacles in the way of the closing window.

To override this protection function when there is a resistance, for example, in the winter, proceed as follows:

1. Close the window twice until it reaches the resistance and let it reverse.

2. Close the window a third time to the resistance. The anti-trap function is disabled and you cannot close the window automatically. The window will override the resistance and you can close it fully.
3. If the window does not close after the third attempt, have it checked by a properly trained technician.

Resetting the memory of the electric windows

WARNING



The anti-trap function is deactivated until you have reset the memory.

After the battery has been disconnected from the vehicle you must reset the memory separately for each window:

1. Lift the switch until the window is fully closed. Hold the switch lifted for one more second.
2. Release the switch and lift it again, two or three times, for one more second.
3. Open the window and try to close it automatically.
4. Reset and repeat procedure if the window does not close automatically.

Safety mode

WARNING



The anti-trap function is not active during this procedure.

If the system detects a malfunction, it enters a safety mode. The windows will move for only about 0.5 seconds at a time and then stop again. Close the windows by pressing the switch again when the windows stop moving. Have this checked immediately.

Windows and mirrors

EXTERIOR MIRRORS

WARNING



Do not overestimate the distance of the objects that you see in the convex mirror. Objects seen in convex mirrors will appear smaller and further away than they actually are.

Manual folding mirrors

Folding

Push the mirror towards the door window glass.

Unfolding

Make sure that you fully engage the mirror in its support when returning it to its original position.

ELECTRIC EXTERIOR MIRRORS

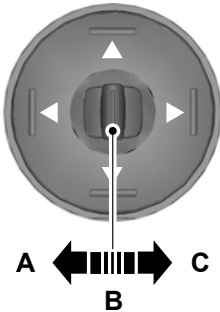

E70846

- A Left-hand mirror
- B Off
- C Right-hand mirror

Mirror tilting positions

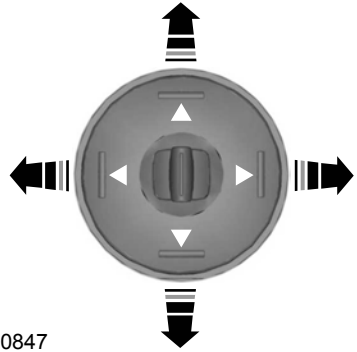

E70847

The electric exterior mirrors are fitted with a heating element that will defrost or demist the mirror glass. See **Heated windows and mirrors** (page 112).

Electric folding mirrors

Automatic folding and unfolding

Note: If the mirrors have been folded using the manual fold button they can only be unfolded using the manual fold button.

The mirrors will fold automatically when you lock the vehicle with the key, the remote control or a keyless entry system request. The mirrors will unfold when you unlock the vehicle with the key, the remote control, a keyless entry system request, the driver's interior door handle or starting the engine.

Manual folding and unfolding

The electric folding mirrors operate with the ignition on.

Note: You can operate the mirrors (mirror tilting and folding) for several minutes after you switch off the ignition. They will be deactivated as soon as a door is opened.

Windows and mirrors



E72623

Press the button to fold or unfold the mirrors.

If you press the switch again while the mirrors are moving, they will stop and reverse the direction of movement.

Note: *When the mirrors are operated often during a short period of time, the system may become inoperable for a period of time to prevent damage due to overheating.*

Reverse mirror dipping

Depending on the switch position (**A** or **C**), the relevant exterior mirror will dip whenever you select reverse gear, giving you a view of the kerb.

Note: *You can disable this feature by leaving the switch in position **B**.*

The exterior mirror will return to the original position:

- If the vehicle speed exceeds 10 km/h (6 mph).
- Approximately 10 seconds after reverse gear has been disengaged.
- If the switch is returned to position **B**.

When you first use this feature, the mirror will dip to a preset position. This position can be adjusted using the following sequence:

1. Turn the ignition on. Do not start the engine.
2. Select the desired exterior mirror (**A** or **C**).
3. Select reverse gear, the selected exterior mirror will adjust to a preset position.
4. Adjust the mirror to the required dipped position.
5. Disengage reverse gear or press and hold the desired memory pre-set button until a single chime sounds to confirm. See **Memory function** (page 134).

The settings will be stored automatically.

AUTO-DIMMING MIRROR

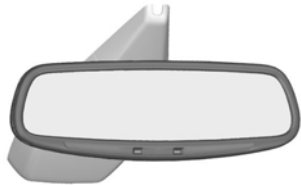

E71028

The auto-dimming mirror will adjust automatically when hit by glaring light from behind. It will not work when you have selected reverse gear.

Windows and mirrors

REAR QUARTER WINDOWS

Manual rear quarter windows

Opening

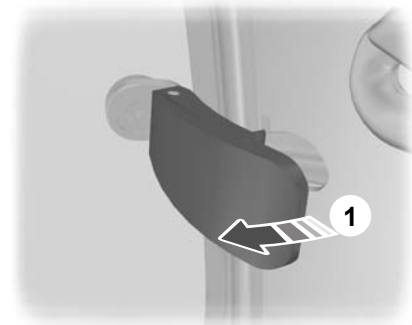

E72126

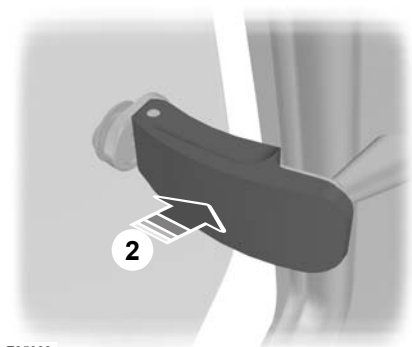

E95383

Closing

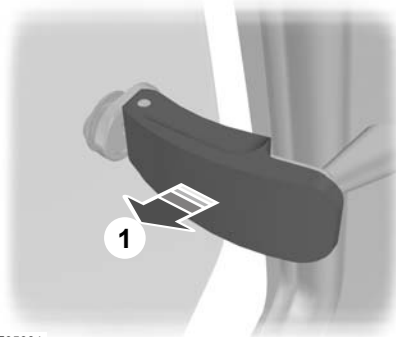

E95384

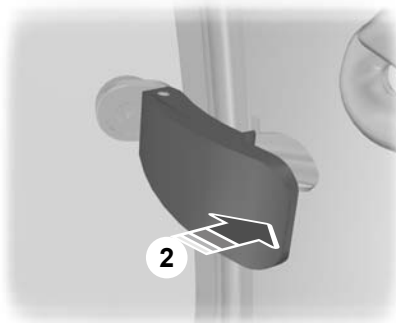

E95385

Note: Make sure that the lever is securely engaged in its catch.

Electric rear quarter windows

Switch on the ignition to operate the rear quarter windows.

Windows and mirrors

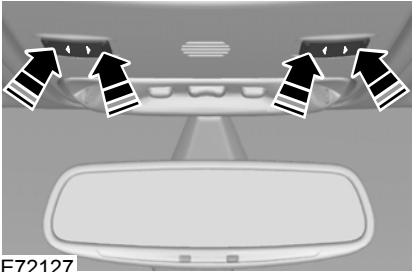

Instruments

GAUGES

Type 1 and 2

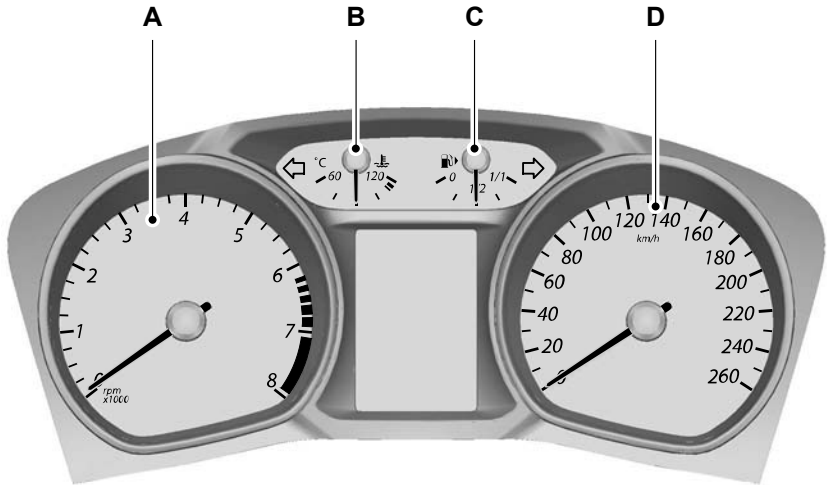

E72984

- A Tachometer
- B Engine coolant temperature gauge
- C Fuel gauge
- D Speedometer

Instruments

Type 3

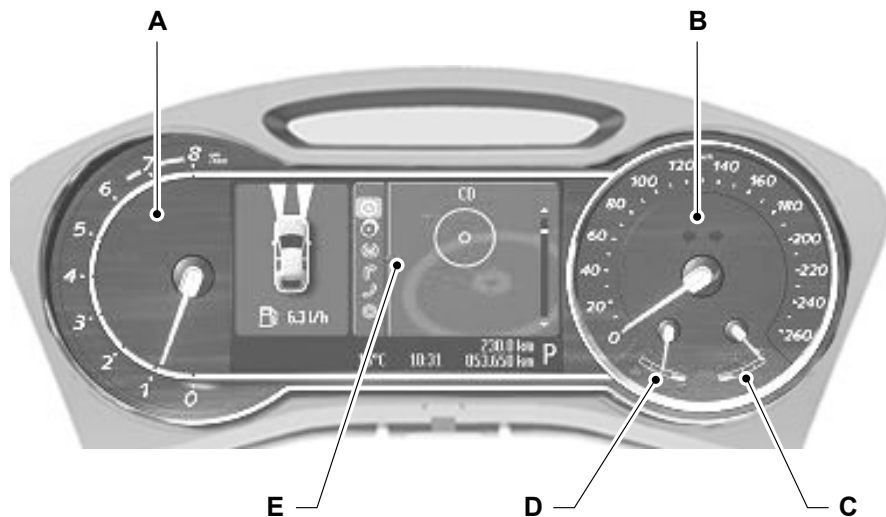

E87713

- A Tachometer
- B Speedometer
- C Engine coolant temperature gauge
- D Fuel gauge
- E Message centre. See **Information displays** (page 82).

Engine coolant temperature gauge

Shows the temperature of the engine coolant. At normal operating temperature, the needle will remain in the centre section.

CAUTION

! Do not restart the engine until the cause of overheating has been resolved.

If the needle moves towards 120°C, the engine is overheating. Stop the engine, switch the ignition off and determine the cause **once the engine has cooled down**. See **Engine coolant check** (page 215).

Instruments

Fuel gauge

The arrow adjacent to the fuel pump symbol tells you on which side of your vehicle the fuel filler cap is located.

WARNING LAMPS AND INDICATORS

The following warning lamps and indicators will illuminate briefly when you switch the ignition on to confirm that the system is operational:

- ABS
- Airbag
- Brake system
- Engine
- Electric parking brake (EPB)
- Frost
- Ignition
- Oil pressure (all except 2.5L Duratec)
- Stability control (ESP)

If a warning or indicator lamp does not illuminate when the ignition is switched on, this indicates a malfunction. Have the system checked by properly trained technician.

ABS warning lamp



If it illuminates when you are driving, this indicates a malfunction. You will continue to have normal braking (without ABS). Have the system checked by a properly trained technician as soon as possible.

Airbag warning lamp



If it illuminates when driving, this indicates a malfunction. Have the system checked by a properly trained technician.

Brake system lamp



It illuminates when the parking brake is engaged.

WARNING



Reduce your speed gradually and stop your vehicle as soon as it is safe to do so. Use your brakes with care.

If it illuminates when you are driving, check that the parking brake is not engaged. If the parking brake is not engaged, this indicates a malfunction. Have the system checked by a properly trained technician immediately.

Cruise control indicator



It will illuminate when you have set a speed using the cruise control system. See **Using cruise control** (page 160). On vehicles with adaptive cruise control (ACC), the indicator will illuminate when ACC is active. See **Using ACC** (page 163).

Direction indicators



Flashes during operation. A sudden increase in the rate of flashing warns of a failed indicator bulb. See **Changing a bulb** (page 59).

Engine warning lamp



If it illuminates with the engine running, this indicates a malfunction. If it flashes when you are driving, **reduce the speed of your vehicle immediately**. If it continues to flash, avoid heavy acceleration or deceleration. Have the system checked by a properly trained technician immediately.

Instruments

CAUTION

 If the engine warning lamp illuminates in conjunction with a message, have the system checked as soon as possible.

Electric parking brake (EPB) warning lamp

 It will illuminate when an EPB warning message is displayed in the information display. See

Electric parking brake (EPB) (page 150).

Forward alert indicator

 It will illuminate when this feature is active. See **Forward alert function** (page 166).

Front fog lamp indicator

 It will illuminate when you switch the front fog lamps on.

Frost warning lamp

 It will illuminate and glow amber when the outside air temperature is between 4°C (39.2°F) and 0°C (32°F). It will glow red when the temperature is below 0°C (32°F).

Glow plug indicator

 See **Starting a diesel engine** (page 139).

Headlamp indicator

 It will illuminate when you switch the headlamp dipped beam or the side and tail lamps on.

Ignition warning lamp

 If it illuminates when you are driving, this indicates a malfunction. Switch off all unnecessary electrical equipment. Have the system checked by a properly trained technician immediately.

Low fuel level warning lamp

 If it illuminates, refuel as soon as possible.

Main beam indicator

 It will illuminate when you switch the headlamp main beam on. It will flash when you use the headlamp flasher.

Maximum engine speed indicator

 It will turn red when the maximum engine speed is reached.

Message indicator

 It will illuminate when a new message is stored in the information display. See **Information messages** (page 95).

Oil pressure warning lamp

CAUTION

 Do not resume your journey if the oil pressure warning lamp illuminates despite the oil level being correct. Have the system checked by a properly trained technician immediately.

Instruments



If the lamp stays on after starting or illuminates during a journey, this indicates a malfunction. Stop your vehicle as soon as it is safe to do so and switch the engine off. Check the engine oil level. See **Engine oil check** (page 215).

Rear fog lamp indicator



It will illuminate when you switch the rear fog lamps on.

Seat belt reminder



See **Seat belt reminder** (page 31).

Stability control (ESP) warning lamp



While driving, it flashes during activation of the system. After switching on the ignition, if it does not illuminate or illuminates continuously while driving, this indicates a malfunction. During a malfunction, the system switches off. Have the system checked by a properly trained technician as soon as possible.

If you switch ESP off, the warning lamp will illuminate. The lamp will go out when you switch the system back on or when you switch the ignition off.

AUDIBLE WARNINGS AND INDICATORS

Switching the chimes on and off

You can deactivate certain chimes.

To set which chimes should sound:

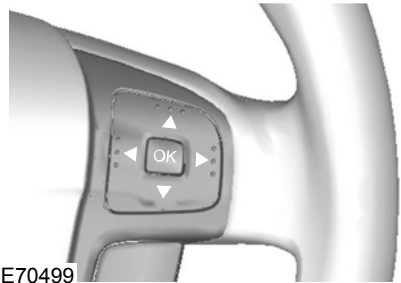

E70499

1. Press the right arrow button on the steering wheel to enter the main menu.
2. Highlight **Setup** with the up and down arrow buttons and press the right arrow button.
3. Highlight **Chimes** and press the right arrow button.
4. Highlight the chime and press the **OK** button to switch the chime on and off.
5. Press the left arrow button to exit the menu. Press and hold the left arrow button to return to the main menu display.

Information displays

GENERAL INFORMATION

WARNING



Do not operate the information display controls when the vehicle is moving.

Note: *The information display will remain on for several minutes after you switch off the ignition.*

Various systems on your vehicle can be controlled using the buttons on your steering wheel. Corresponding information is displayed in the information display.

For detailed instructions on audio, navigation, phone etc. refer to the appropriate manual.

Controls



E70499

Instrument cluster functions

| Function | Type 1 | Type 2 | Type 3 |
|----------------------|--------|--------|--------|
| Trip computer | X | X | X |
| Information messages | X | X | X |
| Clock setup | X | X | X |
| Display settings | - | X | X |
| Park heater setup | - | X | X |

Press the **up** and **down** arrow buttons:

- to scroll through the trip computer displays
- to scroll through and highlight the options within a menu.

Press the **right** arrow button:

- to enter the main menu from the trip computer displays
- to enter a sub-menu.

Press the **left** arrow button to exit a menu.

Hold the **left** arrow button pressed at any time to return to the main menu display (escape button).

Note: *The system will return to the trip computer displays automatically if you do not press any button for a period of time.*

Press the **OK** button to choose and confirm a setting.

Information displays

| Function | Type 1 | Type 2 | Type 3 |
|-------------------------|--------|--------|--------|
| Navigation control | - | - | X |
| CD control | - | - | X |
| CD changer control | - | - | X |
| Radio control | - | - | X |
| Phone control | - | - | X |
| Auxiliary input control | - | - | X |

Type 1

Press the **up** and **down** arrow buttons on the steering wheel to scroll through the trip computer displays. See **Trip computer** (page 91).

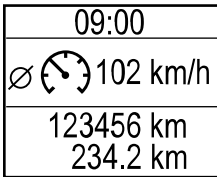

E80604

Menu structure

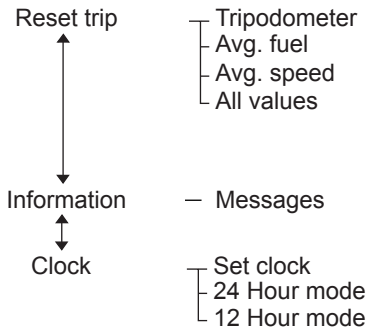

E87751

Information displays

Type 2

| |
|--|
| 09:00 |
|  Average Fuel 6.3 $\frac{l}{100km}$ |
| 123456 km 234.2 km |

E74426

Press the **up** and **down** arrow buttons on the steering wheel to scroll through the trip computer displays. See **Trip computer** (page 91).

Information displays

Menu structure

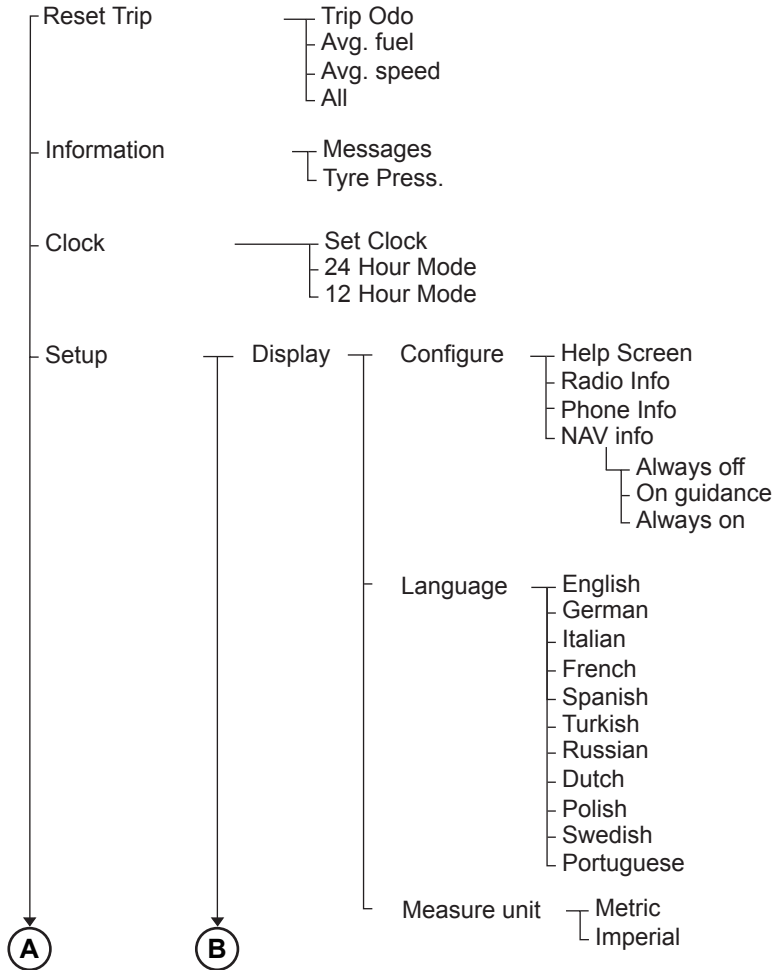

E87752

Information displays

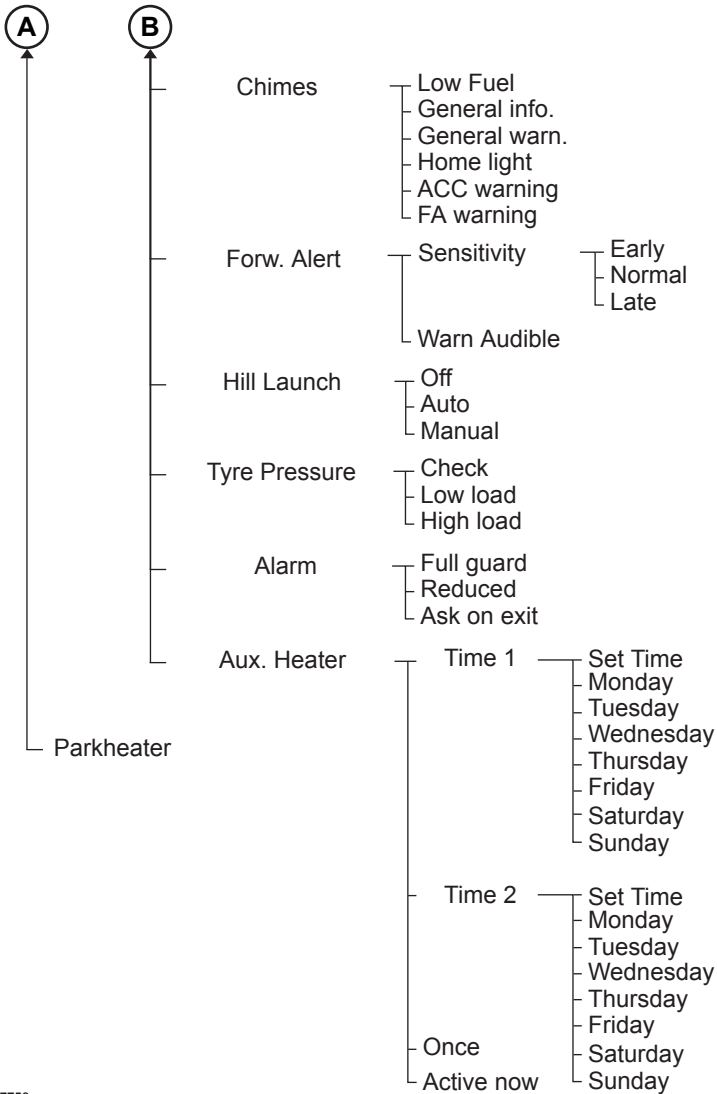

E87753

Information displays

Type 3



E88048

Use the controls to scroll through the menu displays.

Device list

The highlighted icon shows the current menu in use.



Navigation



CD



CD changer



Radio



Phone



Trip computer



Settings



Auxiliary input

Information displays

Menu structure

Navigation



CD



CD changer



Radio



Phone



A

- Home
- Destinat. mem. — Destinations
- Destinat. A-Z — Destinations
- Last destinat. — Destinations
- Cancel guidan.

— Folder / Tracks

- CD 1 — Folder / Tracks
- CD 2 — Folder / Tracks
- CD 3 — Folder / Tracks
- CD 4 — Folder / Tracks
- CD 5 — Folder / Tracks
- CD 6 — Folder / Tracks

- Station list — Stations
- FM 1 / FM — Stations
- FM 2 — Stations
- FM 3 — Stations
- FM - AST — Stations
- MW / AM — Stations
- LW / AM-AST — Stations

- Phone book — Numbers
- Redial
- Incoming calls — Numbers
- Outgoing calls — Numbers
- Call status

E87754

Information displays

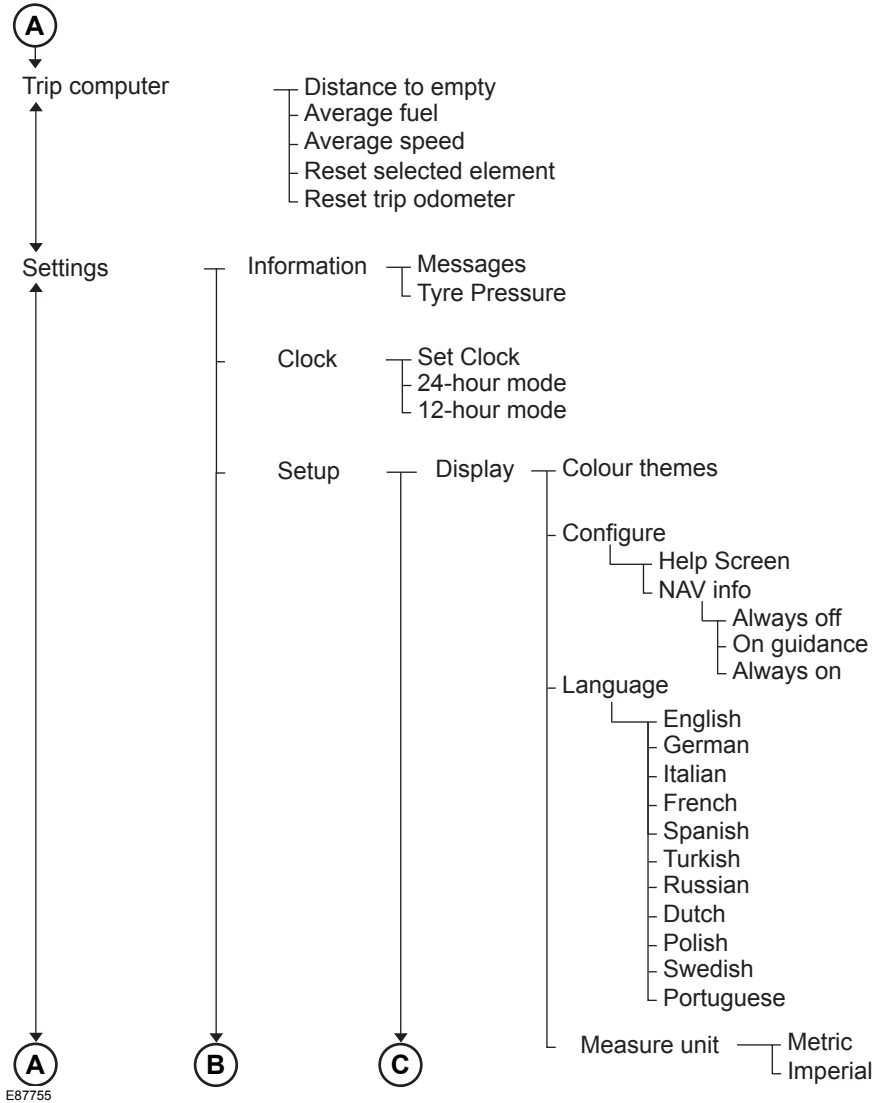

Information displays

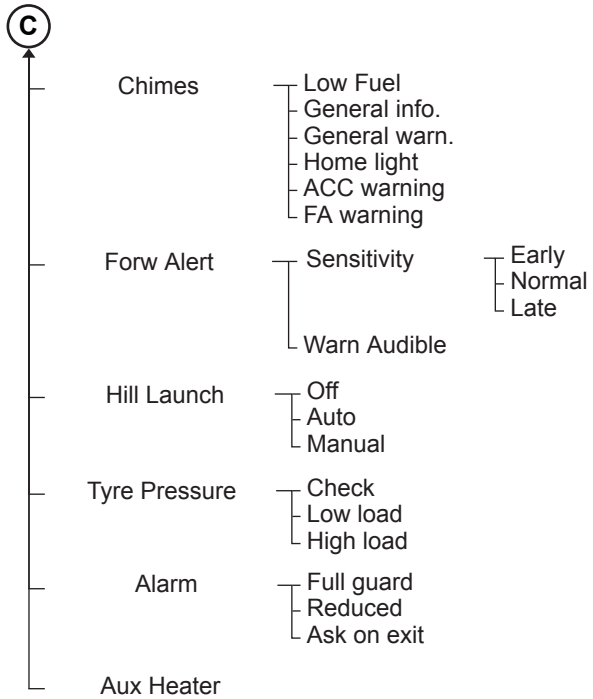

E87756

Information displays

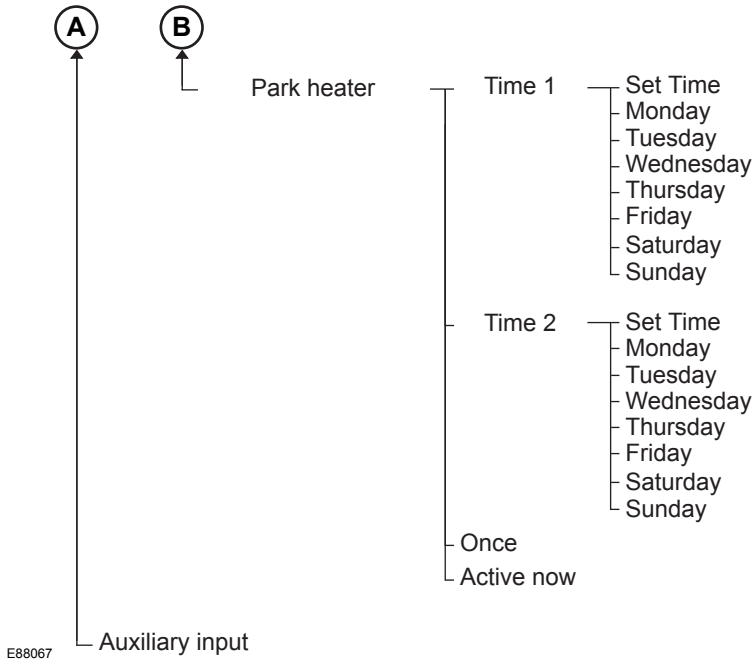

TRIP COMPUTER

Odometer

Registers the total mileage of the vehicle.

Tripmeter

Registers the mileage of individual journeys.

Distance to empty

Indicates the approximate distance the vehicle will travel on the fuel remaining in the tank. Changes in driving pattern may cause the value to vary.

Average fuel consumption

Indicates the average fuel consumption since the function was last reset.

Average speed

Indicates the average speed calculated since the function was last reset.

Outside air temperature

Shows the outside air temperature.

Information displays

Type 1 and 2

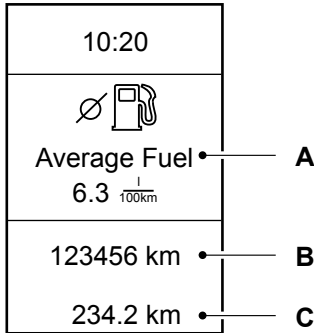

E74428

- A Trip computer
- B Odometer
- C Tripmeter

The trip computer includes the following information displays:

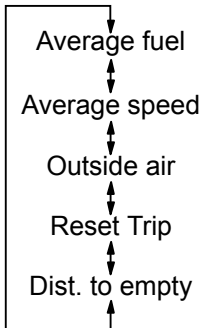

E74441

Press the **up** and **down** arrow buttons on the steering wheel to scroll through the trip computer displays.

Note: The position of the trip computer display may vary depending on the information shown in the display.

Resetting the trip computer using the main menu

To reset a particular display:

1. Press the right arrow button on the steering wheel to enter the main menu.
2. Highlight **Reset Trip** with the up and down arrow buttons and press the right arrow button.
3. Highlight the function to be reset.
4. Press the right arrow button to select the function.
5. Hold the **OK** button pressed.

To reset all three displays, select **All values** and hold the **OK** button pressed.

Type 3

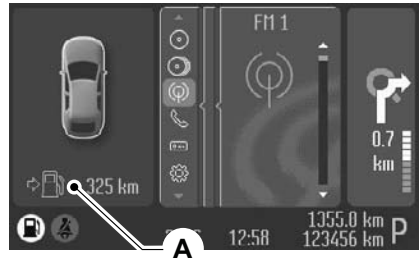

E88049

- A Trip computer

Press the **OK** button on the steering wheel to cycle through the different trip computer displays. To reset a value, press and hold the **OK** button.

Resetting the trip computer using the main menu

To reset a particular display:

Information displays

1. Highlight **Trip Computer** with the up and down arrow buttons and press the right arrow button.
2. Highlight the function to be reset.
3. Hold the **OK** button pressed.

PERSONALISED SETTINGS

The following information is displayed in the information display if you have selected it:

Help screen, radio, navigation and phone information

The help screen appears for a few seconds when you switch the ignition on.

If the radio, navigation or telephone is operating, information relating to this system is displayed in the information display.

To select which information is displayed in the information display:

Type 1 and 2

1. Press the right arrow button on the steering wheel to enter the main menu.
2. Highlight **Setup** with the up and down arrow buttons and press the right arrow button.
3. Highlight **Display** and press the right arrow button.
4. Highlight **Configure** and press the right arrow button.
5. To toggle the **Help screen, Radio Info** and **Phone Info** on and off, highlight the desired setting and press the **OK** button to confirm the setting.
6. Press the left arrow button to exit the menu. Hold the left arrow button pressed to return to the trip computer display.

Type 3

1. Highlight **Settings** with the up and down arrow buttons and press the right arrow button.
2. Highlight **Setup** with the up and down arrow buttons and press the right arrow button.
3. Highlight **Display** and press the right arrow button.
4. Highlight **Configure** and press the right arrow button.
5. To toggle the **Help screen** and **NAV Info** on and off, highlight the desired setting and press the **OK** button to confirm the setting.

Navigation information

You can also choose when the navigation information is displayed in the information display. Three options are available:

- **Always off:** No navigation information is displayed in the information display.
- **On guidance:** The navigation information will only appear when the navigation system provides a guidance instruction. This function is only available on certain navigation systems.
- **Always on:** Navigation information will always appear in the information display when the navigation system is operating.

To set when navigation information should be displayed:

Type 1 and 2

1. Press the right arrow button on the steering wheel to enter the main menu.
2. Highlight **Setup** with the up and down arrow buttons and press the right arrow button.

Information displays

3. Highlight **Display** and press the right arrow button.
4. Highlight **Configure** and press the right arrow button.
5. Highlight **Nav Info** and press the right arrow button.
6. Highlight the desired setting and press the **OK** button to confirm the setting.
7. Press the left arrow button to exit the menu. Hold the left arrow button pressed to return to the trip computer display.

Type 3

1. Highlight **Settings** with the up and down arrow buttons and press the right arrow button.
2. Highlight **Setup** with the up and down arrow buttons and press the right arrow button.
3. Highlight **Display** and press the right arrow button.
4. Highlight **Configure** and press the right arrow button.
5. Highlight **Nav Info** and press the right arrow button.
6. Highlight the desired setting and press the **OK** button to confirm the setting.

Language

A choice of eleven languages are available:

English, German, Italian, French, Spanish, Turkish, Russian, Dutch, Polish, Swedish and Portuguese.

Type 1 and 2

1. Press the right arrow button on the steering wheel to enter the main menu.

2. Highlight **Setup** with the up and down arrow buttons and press the right arrow button.
3. Highlight **Display** and press the right arrow button.
4. Highlight **Language** and press the right arrow button.
5. Highlight the desired setting and press the **OK** button to confirm the setting.
6. Press the left arrow button to exit the menu. Hold the left arrow button pressed to return to the trip computer display.

Type 3

1. Highlight **Settings** with the up and down arrow buttons and press the right arrow button.
2. Highlight **Setup** with the up and down arrow buttons and press the right arrow button.
3. Highlight **Display** and press the right arrow button.
4. Highlight **Language** and press the right arrow button.
5. Highlight the desired setting and press the **OK** button to confirm the setting.

Units of measure

Note: *The outside air temperature is only displayed in degrees Celsius and cannot be set to degrees Fahrenheit.*

To select metric or imperial units:

Type 1 and 2

1. Press the right arrow button on the steering wheel to enter the main menu.
2. Highlight **Setup** with the up and down arrow buttons and press the right arrow button.

Information displays

3. Highlight **Display** and press the right arrow button.
4. Highlight **Measure Unit** and press the right arrow button.
5. Highlight the desired setting and press the **OK** button to confirm the setting.
6. Press the left arrow button to return to exit the menu. Hold the left arrow button pressed to return to the trip computer display.

Type 3

1. Highlight **Settings** with the up and down arrow buttons and press the right arrow button.
2. Highlight **Setup** with the up and down arrow buttons and press the right arrow button.
3. Highlight **Display** and press the right arrow button.
4. Highlight **Measure Unit** and press the right arrow button.
5. Highlight the desired setting and press the **OK** button to confirm the setting.

INFORMATION MESSAGES







Press **OK** to acknowledge and remove some messages from the information display. Other messages will be removed automatically after a short time.

With instrument cluster type 3, certain messages need to be confirmed before you can access the menus.

Message indicator

 The message indicator illuminates to supplement some messages. It will be red or amber depending on the severity of the message and will remain on until the cause of the message has been rectified.

Message symbols

-  See Owner's handbook.
-  Have the system checked at the next service.
-  Have the system checked as soon as possible.
-  Stop your vehicle as soon as it is safe to do so.

Viewing current messages

Type 1 and 2

1. Press the right arrow button on the steering wheel to enter the main menu.
2. Highlight **Information** with the up and down arrow buttons and press the right arrow button.
3. Highlight **Messages** and press the right arrow button.
4. Use the up and down buttons to view the current messages.

Type 3

1. Press the right arrow button on the steering wheel to enter the main menu.

Information displays

2. Highlight **Settings** with the up and down arrow buttons and press the right arrow button.
3. Highlight **Information** with the up and down arrow buttons and press the right arrow button.
4. Highlight **Messages** and press the right arrow button.
5. Use the up and down buttons to view the current messages.

Active suspension

| Message | Message warning lamp | Meaning |
|------------------|----------------------|--|
| IVDC malfunction | amber | The active suspension has malfunctioned. Have this checked as soon as possible. See Using active suspension (page 157). |
| IVDC comfort | - | The active suspension is set to the comfort setting. |
| IVDC normal | - | The active suspension is set to the normal setting. |
| IVDC sport | - | The active suspension is set to the sport setting. |

Alarm

| Message | Message warning lamp | Meaning |
|----------------------------|----------------------|--|
| Alarm triggered | amber | The alarm has been triggered. Check your vehicle for signs of unauthorised access. |
| Alarm system service reqd. | - | The alarm has malfunctioned. Have this checked as soon as possible. |

Information displays

Battery and charging system

| Message | Message warning lamp | Meaning |
|---------------------------|----------------------|---|
| Overvoltage: Stop safely! | red | The charging system voltage is above its normal operating range. Stop your vehicle as soon as it is safe to do so and switch off the ignition. Have this checked as soon as possible. |
| Low battery | amber | The battery voltage is low. Have this checked as soon as possible. |

Climate control

| Message | Message warning lamp | Meaning |
|----------------|----------------------|-----------------------------|
| Aux. Heater on | amber | The auxiliary heater is on. |

Cruise control and Adaptive cruise control (ACC)

| Message | Message warning lamp | Meaning |
|---------------------------|----------------------|---|
| Cruise control active | - | Cruise control is on. |
| Cruise control standby | - | Cruise control is on standby. |
| ACC unavailable | - | Stability control (ESP) may be switched off. Switch ESP back on and try ACC again. Otherwise try switching the ignition off and on to clear this message. |
| ACC malfunction | amber | The ACC has malfunctioned. Have this checked as soon as possible. |
| Clean radar sensor | amber | There may be something blocking the radar sensor. Clear any dirt, snow, water or other objects from the front grille area. |
| Forward Alert malfunction | amber | Forward alert has malfunctioned. Have this checked as soon as possible. |

Information displays

Doors open

| Message | Message warning lamp | Meaning |
|-------------------------------|----------------------|--|
| Driver door open | red | The driver side front door is open. |
| Driver side rear door open | red | The driver side rear door is open. |
| Passenger door open | red | The passenger side front door is open. |
| Passenger side rear door open | red | The passenger side rear door is open. |
| Luggage comp. open | red | The luggage compartment is open. |
| Bonnet open | red | The bonnet is open. |

Engine immobiliser

| Message | Message warning lamp | Meaning |
|--------------------|----------------------|--|
| Immobiliser active | amber | The engine immobiliser is on. See Engine immobiliser (page 41). |

Hill launch assist (HLA)

| Message | Message warning lamp | Meaning |
|---------------------------|----------------------|---|
| Hill Launch not available | amber | HLA has malfunctioned. Have this checked as soon as possible. |
| Hill Launch Assist active | - | HLA is on. |
| Hill Launch Assist off | - | HLA is off. |
| Please use park brake ! | amber | HLA is deactivated due to a malfunction. Use the parking brake normally on hills. See Hill launch assist (HLA) (page 154). |

Information displays

Lighting

| Message | Message warning lamp | Meaning |
|----------------------------|----------------------|---|
| Front lights malfunction | amber | The adaptive front lighting system (AFS) has malfunctioned. Have this checked as soon as possible. |
| Low beam: Bulb fault | - | One or both of the headlamp dipped beam bulbs have blown. Check the headlamp dipped beam bulbs. See Changing a bulb (page 59). |
| Rear fog light: Bulb fault | - | One or both of the rear fog lamp bulbs have blown. Check the rear fog lamp bulbs. See Changing a bulb (page 59). |
| Stop lamps: Bulb fault | - | One or both of the brake lamp bulbs have blown. Check the brake lamp bulbs. See Changing a bulb (page 59). |
| Trailer stopl.: Bulb fault | - | One or both of the brake lamp bulbs on your trailer have blown. Check the brake lamp bulbs on your trailer. |
| Trailer turnl.: Bulb fault | - | One or both of the direction indicator bulbs on your trailer have blown. Check the direction indicator bulbs on your trailer. |

Maintenance

| Message | Message warning lamp | Meaning |
|------------------------|----------------------|--|
| Engine malfunction | red | The engine system has malfunctioned. Have this checked as soon as possible. |
| Check engine oil level | amber | The engine oil level is low. Check the engine oil level as soon as possible. See Engine oil check (page 215). |
| Water detected in fuel | amber | There is water in the fuel. Have this checked as soon as possible. |
| Low washer fluid level | - | The washer fluid level is low. Check the washer fluid level. See Washer fluid check (page 216). |

Information displays

| Message | Message warning lamp | Meaning |
|-------------|----------------------|--|
| Service oil | - | The engine oil needs to be changed. Have the engine oil changed as soon as possible. |

Occupant protection

| Message | Message warning lamp | Meaning |
|------------|----------------------|--|
| Crash mode | - | Have the system checked as soon as possible. |

Parking brake

| Message | Message warning lamp | Meaning |
|--------------------|----------------------|--|
| Park brake applied | amber | Release the brake when driving. Failure to do so will result in the rear brakes overheating. |
| Park brake applied | red | Release the brake when driving. Failure to do so will result in the rear brakes overheating. |

Electric parking brake (EPB)

| Message | Message warning lamp | Meaning |
|--------------------------|----------------------|--|
| Park brake malfunction | red | The EPB has malfunctioned. Have this checked as soon as possible. |
| Release park brake | red | Release the EPB. See Electric parking brake (EPB) (page 150). |
| Re-Apply park brake | red | Apply the EPB again. See Electric parking brake (EPB) (page 150). |
| Park brake applied | amber | The EPB is applied. |
| Park brake released | amber | The EPB is released. |
| Park brake service reqd. | - | The EPB has malfunctioned. Have this checked as soon as possible. |

Information displays

Power steering

| Message | Message warning lamp | Meaning |
|----------------------------|----------------------|---|
| Power steering malfunction | amber | The power steering system has malfunctioned. Have this checked as soon as possible. |

Stability control (ESP)

| Message | Message warning lamp | Meaning |
|-----------------|----------------------|---|
| ESP off | - | Stability control is off. |
| ESP malfunction | - | Stability control has malfunctioned. Have this checked as soon as possible. |

Transmission

| Message | Message warning lamp | Meaning |
|------------------------------|----------------------|--|
| Transmission malfunction | red | The transmission has malfunctioned. Have this checked as soon as possible. |
| Transmission over-temperatur | amber | The transmission is over heating. Have this checked as soon as possible. |

Tyre pressure monitoring system

| Message | Message warning lamp | Meaning |
|----------------------|----------------------|---|
| Check tyre! | red | The tyre indicated has continued to deflate. Check the tyre and inflate it to the recommended pressure. See Technical specifications (page 235). |
| Check tyre pressures | red | One or more of the tyres are significantly under-inflated. This message may be displayed after a new sensor has been installed. Check the tyres and inflate them to the recommended pressure. See Technical specifications (page 235). |

Information displays

| Message | Message warning lamp | Meaning |
|------------------------------|----------------------|--|
| Check tyre | amber | The tyre indicated is significantly under-inflated. Check your tyres and inflate them to the recommended pressure. See Technical specifications (page 235). |
| Tyre monitor malfunction | amber | You have installed a temporary spare wheel. Install a correctly inflated full size wheel with a sensor as soon as possible. When a malfunction occurs, the system may not be able to detect or signal low tyre pressure. |
| | | Up to three sensors have malfunctioned, an unapproved accessory is interfering with the system or a general malfunction has been detected. Have the system checked as soon as possible. When a malfunction occurs, the system may not be able to detect or signal low tyre pressure. |
| Inflate tyres for high speed | amber | The tyre pressures are not suitable for driving at 160 km/h (100 mph). Inflate the tyres to the recommended pressure. See Technical specifications (page 235). This message will be displayed for only a few seconds with a low tyre pressure warning. |
| Tyre sensors not detected | - | You have installed wheels and tyres that do not have sensors. The tyre pressures will not be monitored. |
| | | All sensors have malfunctioned or an unapproved accessory is interfering with the system. Have this checked as soon as possible. |

Information displays

Voice control

| Message | Message warning lamp | Meaning |
|---------------------------------|-----------------------------|--|
| Voice control Please speak | - | Voice control is on. |
| Voice control Not recognised | - | Check voice control. |
| Voice control Not allowed | - | Voice control is not allowed in this mode. |

Climate control

PRINCIPLE OF OPERATION

Outside air

Keep the air intakes forward of the windscreen free from obstruction (snow, leaves etc.) to allow the climate control system to function effectively.

Recirculated air

CAUTION

⚠ Prolonged use of recirculated air may cause the windows to mist up. If the windows mist up, follow the settings for defrosting and demisting the windscreen.

The air currently in the passenger compartment will be recirculated. Outside air will not enter the vehicle.

Heating

Heating performance depends on the temperature of the engine coolant.

Air conditioning

Note: *The air conditioning operates only when the temperature is above 4°C (39°F).*

Note: *If you use the air conditioning, the fuel consumption of your vehicle will be higher.*

Air is directed through the evaporator where it is cooled. Humidity is extracted from the air to help keep the windows free of mist. The resulting condensation is directed to the outside of the vehicle and it is therefore normal if you see a small pool of water under your vehicle.

General information on controlling the interior climate

Fully close all the windows.

Warming the interior

Direct the air towards your feet. In cold or humid weather conditions, direct some of the air towards the windscreen and the door windows.

Cooling the interior

Direct the air towards your face.

AIR VENTS

Front air vents

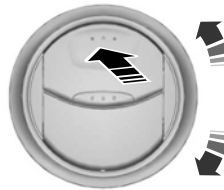

E71942

Climate control

Second row air vents

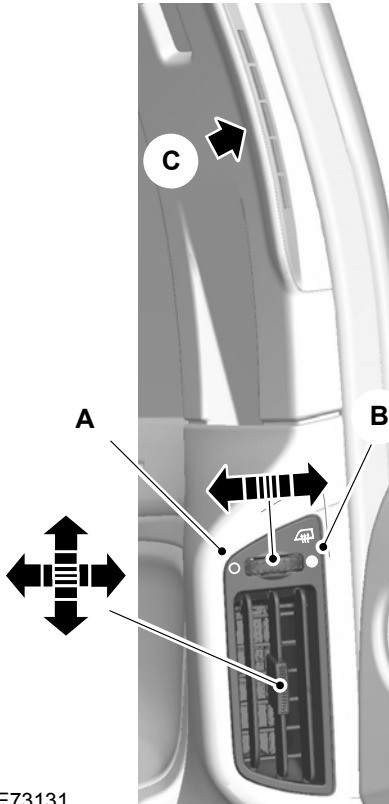

E73131

- A Air flow through lower air vent
- B Air flow through upper air vent
- C Upper air vent

Use the upper air vents to defrost or demist the side windows.

Third row air vents

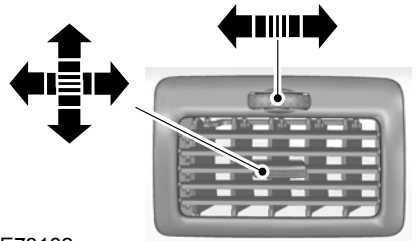

E73132

MANUAL CLIMATE CONTROL

Air distribution control

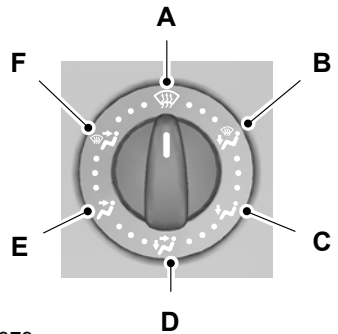

E71379

- A Windscreens
- B Footwell and windscreen
- C Footwell
- D Face level and footwell
- E Face level
- F Face level and windscreen

Climate control

You can set the air distribution control to any position between the symbols.

Blower

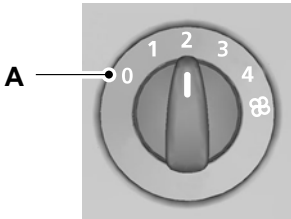

E75470

A Off

Note: If you switch the blower off, the windscreen may mist up.

Recirculated air



Press the button to toggle between outside air and recirculated air.

Heating the interior quickly

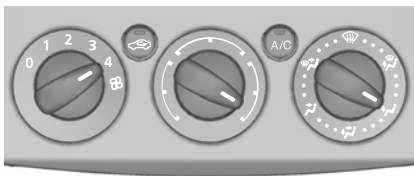

E71377

Ventilation

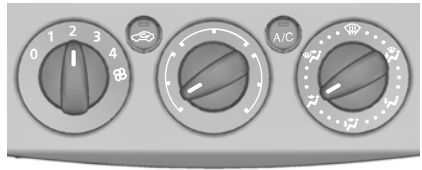

E71378

Set the air distribution control, blower and air vents to suit your requirements.

Air conditioning

Switching the air conditioning on and off



If you turn the blower off, the air conditioning will turn off. When you turn the blower on again, the air conditioning will come on automatically.

Cooling with outside air

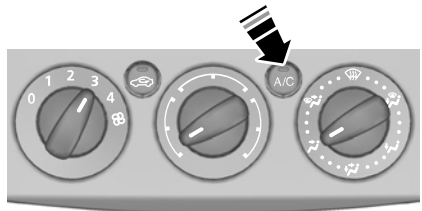

E71380

Climate control

Cooling the interior quickly

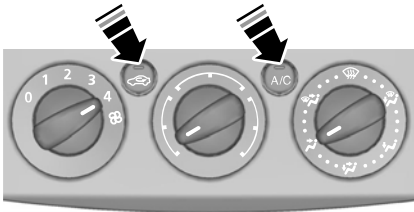

E71381

Defrosting and demisting the windscreen

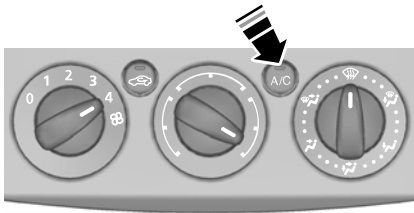

E71382

When the temperature is above 4°C (39°F), the air conditioning will switch on automatically. Make sure that the blower is on. The indicator in the switch will illuminate during defrosting and demisting.

If you move the air distribution control to a position other than **A**, the **A/C** will remain on.

You can switch the air conditioning and recirculated air on and off while the air distribution control is set to position **A**.

If necessary, switch the heated windows on. See **Heated windows and mirrors** (page 112).

Note: To defrost or demist the rear side windows, set the second row air vents to the defrosting and demisting position. See **Air vents** (page 104).

Reducing interior air humidity

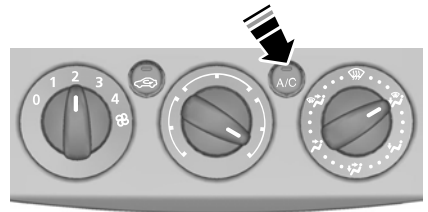

E71383

Climate control

AUTOMATIC CLIMATE CONTROL

Dual-zone



E80737

Triple-zone



E70302

Climate control

Your vehicle is fitted with either a dual-zone or triple-zone system. When the system is in mono mode, all the temperature zones are linked to the driver's zone. When you switch mono mode off, the dual-zone system allows you to set different temperatures for the driver's and passenger's side. On vehicles fitted with a triple-zone system, you can set a third temperature for the rear.

The system controls the temperature, amount and distribution of the air flow automatically and adjusts them according to the driving and weather conditions. Press the **AUTO** button to switch auto mode on.

Note: Avoid adjusting the settings when the vehicle interior is extremely hot or cold. The system adjusts to the current circumstances automatically. For the system to function properly, the side and centre air vents should be fully open.

Note: At low outside air temperatures, when the system is in auto mode, the air stream will be directed to the windscreen and the side windows as long as the engine is cold.

Note: For information on the automatic climate control, on vehicles fitted with a combined Navigation and automatic climate control system, see separate handbook.

Setting the temperature



E70304

You can set the temperature between 16°C (61°F) and 28°C (82°F) in steps of 0.5°C (1°F). In position **LO** (below 16°C [61°F]) the system will switch to permanent cooling, in position **HI** (above 28°C [82°F]) to permanent heating, and will not regulate a stable temperature.

Mono mode

In mono mode, the temperature settings for both the driver's and passenger's side are linked. If you adjust the temperature using the rotary control on the driver's side, the same temperature will be set for the passenger's side. **MONO** is shown in the display.

To switch mono mode off

Select a temperature for the passenger's side using the rotary control on the passenger's side. Mono mode will switch off and **MONO** disappears from the display. The temperature for the driver's side will remain unchanged. You can now adjust the driver's and passenger's side temperatures independently of each other. The temperatures are shown in the display. You can set a difference of up to 4°C (7°F).

Note: If you set a difference of greater than 4°C (7°F), the temperature on the other side will be adjusted so that the difference remains at 4°C (7°F).

Note: If you set one of the sides to **HI** or **LO**, both sides will be set to **HI** or **LO**.

To switch mono mode back on



Press the **MONO** button. **MONO** is shown in the display, and the passenger's side temperature will be adjusted to the driver's side temperature.

Climate control

Blower

High speed



Low speed



Use the buttons to adjust the blower speed.

The blower setting is shown in the display.



To return to auto mode, press the **AUTO** button.

Air distribution

To adjust air distribution, press the desired button. Any combination of settings can be selected simultaneously.

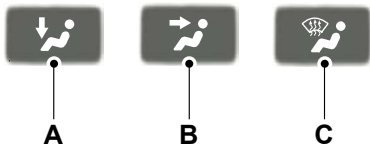

E70308

- A Footwell
- B Face level
- C Windscreen

Windscreen defrosting and demisting



When you select windscreen defrosting and demisting, **A**, **B** and **C** switch off automatically and the air conditioning switches on. Outside air will flow into the vehicle. You cannot select recirculated air.

The blower speed and the temperature control operate automatically and cannot be adjusted manually. The blower is set to high speed and the temperature to **HI**.

When you select windscreen defrosting and demisting, the heated screens switch on automatically and switch off after a short time.

To return to auto mode, press the **AUTO** button.

Note: To defrost or demist the rear side windows, set the second row air vents to the *defrost or demist position*. See **Air vents** (page 104).

Switching the air conditioning on and off



Press the button. **A/C OFF** or **A/C ON** is shown in the display.

Recirculated air



Press the button to change between outside air and recirculated air.

Note: When the system is in auto mode and the interior and exterior air temperatures are quite hot, the system selects recirculated air automatically to maximise cooling of the interior. Once the selected temperature is reached, the system will automatically reselect outside air.

Climate control

Switching the automatic climate control on and off

Note: When switched off, the heating, ventilation and air conditioning system for both front and rear zones are switched off and recirculated air is selected.

Dual-zone



E70980

Use the buttons to switch the system on and off.

Triple-zone

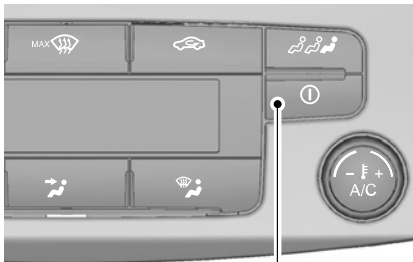

A

E70312

Press button **A** to switch the system on and off.

Rear air conditioning (triple-zone automatic climate control)

Note: This is a cooling system only. You can use it to cool the rear. The system will not change the rear setting to a temperature higher than the average of the two front temperature settings.

Note: When switched off, you cannot set a temperature for the rear which is lower than the average of the two front temperature settings.

Switching between front and rear air conditioning mode

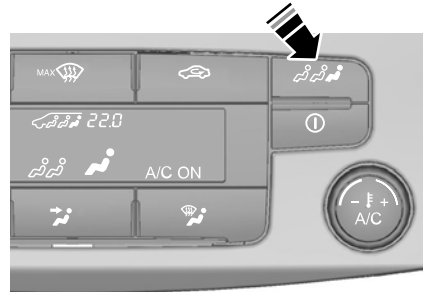

E70313

Press the button. The rear air conditioning symbol and the rear settings will be shown in the display.

When the system is in rear air conditioning mode, you can select a temperature using the rotary control on the driver's side.

To return to the front settings, press the button again. If no button is pressed for a few seconds, the system will automatically return to the front settings.

Climate control

Rear temperature

Note: If you set different temperatures for the driver's side and rear, mono mode will be switched off.

Note: When you press the **MONO** button, all three temperature zones will be adjusted to the temperature set for the driver's side.

Switching the rear air conditioning on and off



When the system is in rear air conditioning mode, use the button to switch the system on and off. **A/C OFF** or **A/C ON** is shown in the display.

Note: When the front air conditioning is switched off, you cannot have rear air conditioning.

Rear blower

High speed



Low speed



When the system is in rear air conditioning mode, use the buttons to adjust the blower speed.

The blower setting is shown in the display.



When the system is in rear air conditioning mode, press the **AUTO** button to return to auto mode. In auto mode, the rear blower is automatically controlled. **AUTO** is shown in the display.

Switching the rear automatic climate control on and off

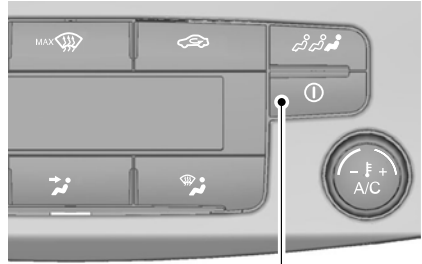

A

E70312

When the system is in rear air conditioning mode, press button **A** to switch only the rear system on and off.

HEATED WINDOWS AND MIRRORS

Heated windows

Use the heated windows to defrost or demist the windscreen or rear window.

Note: The heated windows operate only when the engine is running.

Heated windscreen



Heated rear window



Climate control

Heated exterior mirrors

Electric exterior mirrors are fitted with a heating element that will defrost or demist the mirror glass. They will switch on automatically when you switch the heated rear window on.

AUXILIARY HEATER

Parking heater

WARNING



The parking heater must not be operated at filling stations, near sources of combustible vapours or dust or in enclosed spaces.

The parking heater operates independently of the vehicle heater by heating the engine's coolant circuit. It is fed from the vehicle fuel tank. You can also use it while the vehicle is in motion to help the vehicle heater warm up the interior more quickly.

Used properly, the parking heater provides the following benefits:

- It preheats the interior of the vehicle.
- It keeps the windows clear of ice in the event of frost and prevents condensation.
- It avoids cold starts and allows the engine to reach operating temperature sooner.

Note: The parking heater will only operate if there is at least 7.5 litres (1.6 gallons) of fuel in the fuel tank and the ambient temperature is below 15°C (59°F). The heater will not operate if the battery is low.

Note: The heating depends on the outside air temperature.

Note: When the parking heater is activated, exhaust fumes may come from under the sides of the vehicle. This is normal.

Note: On vehicles with a manual heating, ventilation and air conditioning system, the heating of the vehicle interior is dependent on the temperature, air distribution and blower control settings.

To prevent the battery from discharging:

- Once the parking heater has performed one heating cycle, the next programmed heating cycle will only be carried out if you have started the vehicle's engine in between.
- After a heating cycle, drive the vehicle for at least the period of the heating cycle.

Programming the parking heater

Note: The programmed time is the time at which you wish the vehicle to be warm and ready to drive, not the time at which the heater switches on.

Note: You must programme the times at least 70 minutes in advance of the time you wish to set.

Note: You must set the time and date correctly. See **Clock** (page 128).

To programme the heating times:



Climate control

1. Press the right arrow button on the steering wheel to enter the main menu.
2. Highlight **Setup** with the up and down arrow buttons and press the right arrow button.
3. Highlight **Park Heater** and press the right arrow button.

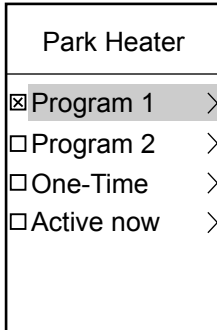

E74467

- The functions **Program 1** and **Program 2** allow you to programme up to two heating cycles for each day of the week. These times will remain stored and the heater will warm up the vehicle at these times on these days every week.
- The function **One-Time** allows you to programme one heating cycle for one specific day.
- The function **Active now** automatically switches on the heater.

Programming the functions Program 1 and Program 2

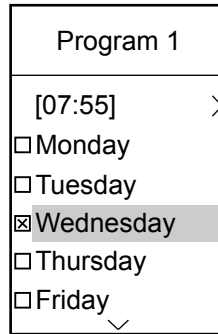

E74468

1. Highlight **Program 1** and press the right arrow button.
2. Highlight the day on which the heater should warm up the vehicle.
3. Press the **OK** button to confirm the selection. A cross appears in the box next to the day to show that this day is selected.
4. Continue in the same way to select all the days on which the heater should warm up the vehicle.
5. To set the time at which the vehicle should be warmed up, highlight the time at the top of the display and press the right arrow button.
6. Press the **OK** button and the hours flash. Use the up and down arrow buttons to adjust the individual settings and the left and right arrow buttons to move to the next or previous setting.
7. When you have finished, press the **OK** button again to confirm the selection.

Climate control

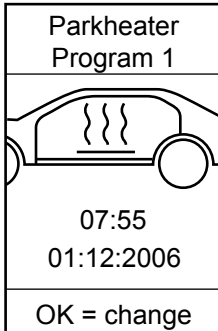

E74469

You can use the function **Program 2** to set a second cycle, for example different times on different days or twice on the same day. The programming procedure is the same as for the function **Program 1**.

Programming the function One-Time

1. Highlight **One-Time** and press the right arrow button.
2. Press the **OK** button and the hours flash. Use the up and down arrow buttons to adjust the individual settings and the left and right arrow buttons to move to the next or previous setting.
3. When you have finished, press the **OK** button again to confirm the selection.

Active now

Highlight **Active now** and press the **OK** button. A cross appears in the box next to the function to show that the heater is activated.

To deactivate the heater, highlight **Active now** and press the **OK** button again.

Diesel auxiliary heater (depending on country)

The diesel auxiliary heater (PTC electrical heater) aids in warming the engine and the vehicle interior on vehicles with a diesel engine. It is switched on or off automatically depending on the outside air temperature, the coolant temperature and the alternator load.

Fuel operated heater (depending on country)

The fuel operated heater aids in warming the engine and the vehicle interior on vehicles with a petrol or diesel engine. It is switched on or off automatically depending on the outside air temperature and the coolant temperature, unless you have deactivated it. When the fuel operated heater is operating, **Aux. Heater on** is displayed in the information display. See **Information displays** (page 82).

To deactivate the fuel operated heater:



E70499

1. Press the right arrow button on the steering wheel to enter the main menu.
2. Highlight **Setup** with the up and down arrow buttons and press the right arrow button.

Climate control

3. Highlight **Aux. Heater** and press the **OK** button to toggle the heater on and off. A cross appears in the box when the heater is activated.
4. Press the left arrow button to exit the menu. Hold the left arrow button pressed to return to the trip computer display.

Remote starting

The parking heater may be started and switched off from a distance of up to 500 metres (1640 feet) using the supplied remote control transmitter. This range will vary depending upon local conditions and terrain, as well as battery condition. The remote control transmitter will indicate whether or not the signal has been received. The parking heater will operate for a maximum of 50 minutes.

Starting

Hold the transmitter with the antenna upwards and press the ON button for 1 - 2 seconds. The LED on the transmitter lights up green to confirm the signal has been received.

Switching off

Hold the transmitter with the antenna upwards and press the OFF button for 1 - 2 seconds. The LED on the transmitter lights up red to confirm the signal has been received.

Remote start in combination with direct start or timer

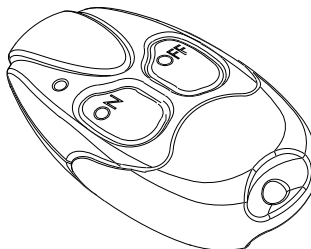

E114360

Remote start is integrated with normal heater control. Parking heaters started with direct start or timer functions can be switched off with the remote control transmitter and vice versa.

Feedback during starting and switching off

The LED on the transmitter illuminates green for about two seconds. This indicates the signal has been received by the vehicle and the heater has started.

The LED on the transmitter illuminates red for about two seconds. This indicates the signal has been received by the vehicle and the heater has switched off.

The LED on the transmitter flashes green or red for about two seconds. This indicates the signal was not transmitted correctly. Repeat the transmission.

Note: *Transmitter range is dependant upon distance and local conditions such as buildings, etc.*

The LED on the transmitter illuminates orange for about two seconds before showing green or red. This indicates the transmitter batteries are weak and should be changed.

Climate control

The LED on the transmitter flashes orange for about 5 seconds. This indicates that the signal was not transmitted. The transmitter batteries are discharged and should be changed as soon as possible.

Changing the remote control battery

Make sure that you dispose of old batteries in an environmentally friendly way. Seek advice from your local authority regarding recycling.

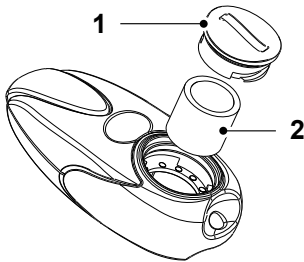

E114361

1. Insert a screwdriver or other suitable tool into the slot on the back of the remote control, and unscrew the compartment cover.

CAUTION



Do not touch the battery contacts or the printed circuit board with the screwdriver.

2. Carefully prise out the battery.
3. Install a new battery (3.3V type CR1-3N) with the + facing upwards.
4. Re-assemble the remote control.

Programming the transmitter

Further transmitters may be used with the remote system, please consult your dealer. Up to a maximum of 3 separate remote controls may be added. When adding extra transmitters these must be programmed separately.

Note: *The heater must be switched off during programming.*

Note: *The programming procedure may be repeated as often as is required. The oldest programmed transmitter will be deleted each time.*

1. Install the battery in the new transmitter.
2. Turn off the power to the receiver by removing fuse F32 from the engine compartment fuse box. See **Fuse specification chart** (page 195).
3. Wait for at least 5 seconds.
4. Reconnect power to the receiver by replacing the fuse, and press the OFF button on the new transmitter within 5 seconds until the LED light turns off.
5. The new transmitter is now programmed.

Seats

SITTING IN THE CORRECT POSITION

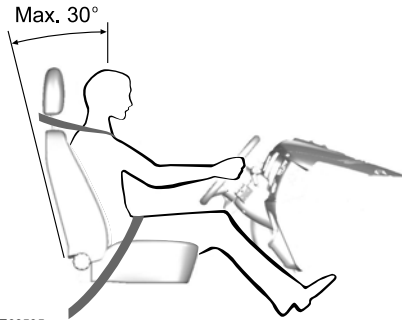

E68595

WARNINGS



Do not adjust the seats when the vehicle is moving.



Only when you use the seat belt properly, can it hold you in a position that allows the airbag to achieve its optimum effect.

When you use them properly, the seat, head restraint, seat belt and airbags will provide optimum protection in the event of a collision. We recommend that you:

- sit in an upright position with the base of your spine as far back as possible.
- do not recline the seatback more than 30 degrees.
- adjust the head restraint so that the top of it is level with the top of your head and as far forwards as possible, remaining comfortable.
- keep sufficient distance between yourself and the steering wheel. We recommend a minimum of 250 millimetres (10 inches) between your breastbone and the airbag cover.

- hold the steering wheel with your arms slightly bent.
- bend your legs slightly so that you can press the pedals fully.
- position the shoulder strap of the seat belt over the centre of your shoulder and position the lap strap tightly across your hips.

Make sure that your driving position is comfortable and that you can maintain full control of your vehicle.

MANUAL SEATS

Moving the seats backwards and forwards

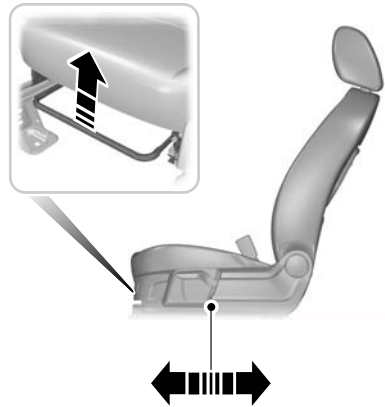

WARNING



Rock the seat backwards and forwards after releasing the lever to make sure that it is fully engaged in its catch.

Seats

Adjusting the lumbar support



E70729

Adjusting the angle of the seatback

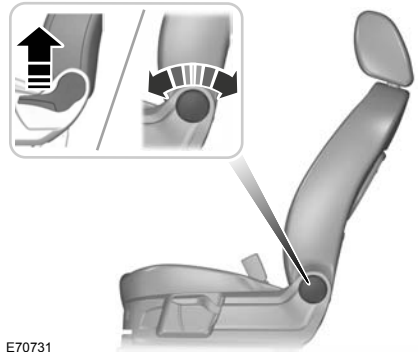

E70731

Adjusting the height of the driver's seat

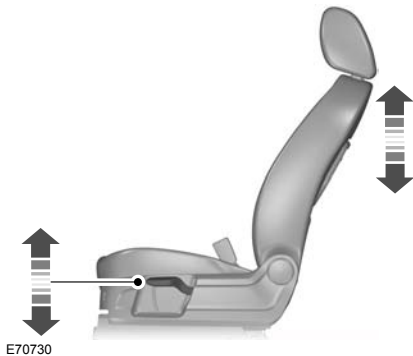

E70730

ELECTRIC SEATS

2-way electric seat

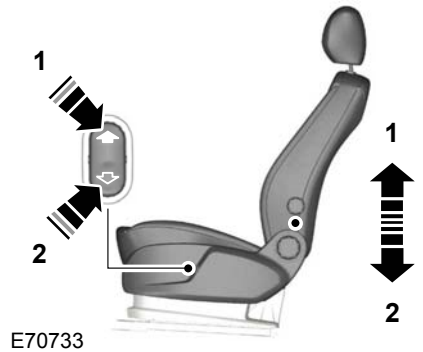

E70733

Seats

8-way electric seat

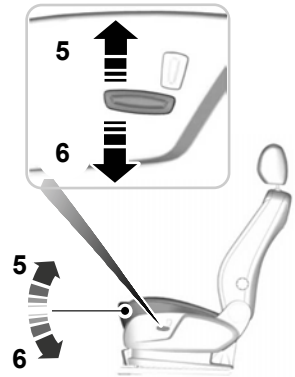
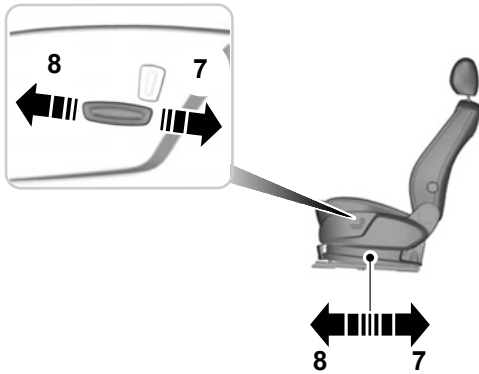
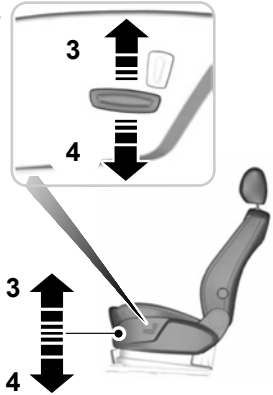
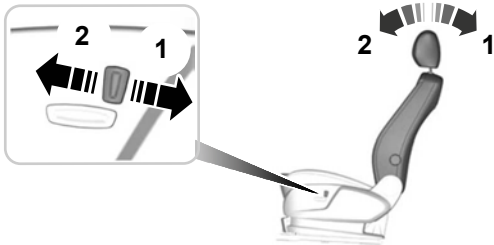



E70734

Seats

HEAD RESTRAINTS

Adjusting the head restraint

WARNINGS

-  Raise the rear head restraint when the rear seat is occupied by a passenger.
-  When using a forward facing child restraint on a rear seat, always remove the head restraint from that seat.

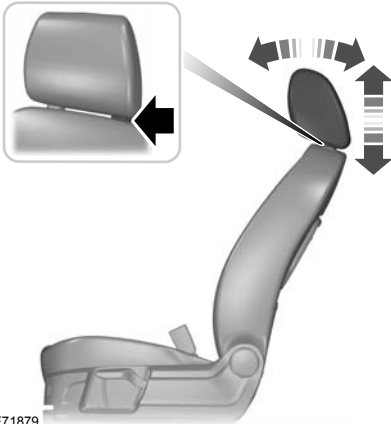

E71879

Adjust the head restraint so that the top of it is level with the top of your head and as far forwards as possible, remaining comfortable.

Removing the head restraint

Press the locking buttons and remove the head restraint.

REAR SEATS

Second row seats

Moving the seats backwards and forwards

WARNING

-  Rock the seat backwards and forwards after releasing the lever to make sure that it is fully engaged in its catch.



E72644

Seats

Adjusting the seatback

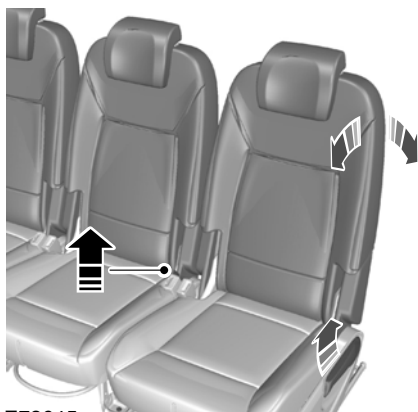

E72645

1. To recline the seatback, pull the lever on the outboard seats or the strap on the centre seat and lean back against the seatback until it reaches the desired position.
2. To raise the seatback, pull the lever up and push the seat cushion forwards using your weight.

Easy entry position (vehicles with third row seats only)

Note: You can move the outboard seats forwards to allow access to the third row seats.



E72704



E72706

1. Pull the lever once. Fold the seatback forwards into the position shown and slide the complete seat forwards. When exiting the vehicle from the third row seats, pull the loop on the rear of the second row seat.
2. To return the seat to the seating position, slide the seat backwards. The seat will stop automatically and at a midway position.

Seats

3. Fold the seatback up until it engages.
4. To move the seat further back, pull the lever under the front of the seat and slide it backwards.

Folding the seatbacks down

WARNING



When folding the seatbacks down, take care not to get your fingers caught between the seatback and seat frame.



E72705

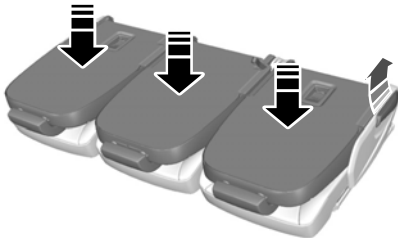

E72646

1. Lower the head restraints. See **Head restraints** (page 121).
2. Slide the seats backwards as far as they will go.
3. Insert the centre seat belt into the retainer in the roof. See **Fastening the seat belts** (page 29).
4. On the outboard seats, pull the lever and fold the seatback into a sloped position. Pull the lever again and fold down the seatback.
5. On the centre seat, pull the loop between the seat cushion and the seatback and fold down the seatback.
6. To engage the seatbacks in the folded position, pull the lever or loop again and push the seatback firmly down until it latches into position.

To return the seat to the seating position, pull the lever or loop and fold the seatback up until it engages.

Third row seats

WARNING



Do not sit in a third row seat when the second row seat in front of it is folded flat.

Moving the seats backwards and forwards (Galaxy)

WARNING



Rock the seat backwards and forwards after releasing the lever to make sure that it is fully engaged in its catch.

Seats

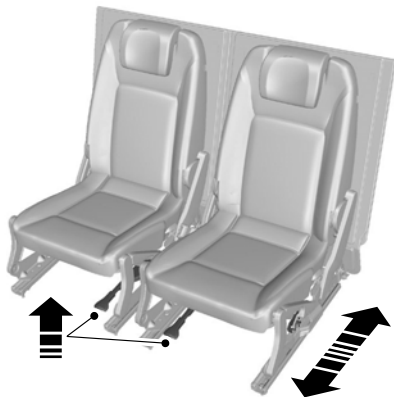

E72647

Adjusting the seatback (Galaxy)



E75381

1. To recline the seatback, pull the strap and lean back against the seatback until it reaches the desired position.
2. To raise the seatback, pull the strap and let the seatback return to the upright position.

Folding the seats flat

WARNING



When folding the seatbacks down, take care not to get your fingers caught between the seatback and seat frame.



E72707

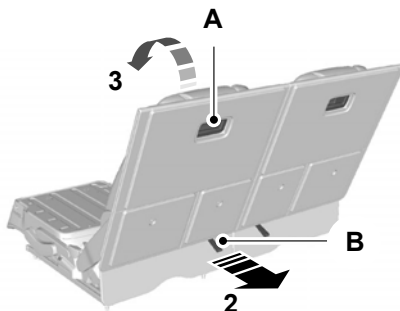

E72648

Seats

1. Pull the loop at the rear of the seat cushion and fold the seat cushion forwards until it lies flat on the floor (1).
2. Grasp the grip (A) and pull the loop (B) at the base of the seatback upwards and rearwards (2).
3. Fold the seatback down flat to the floor using the grip (3).
4. To return the seat to the seating position, grasp the grip and pull the seatback upwards and then rearwards.
5. Fold the seat cushion back.

Creating a level load floor

CAUTION

 When transporting a load with the seats folded flat, always fold the relevant carpeted cover forwards to cover the folded seats.

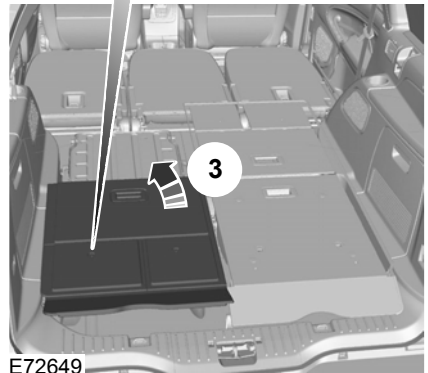
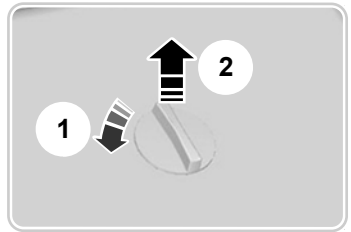

E72649

1. Turn the retainers on the rear of the third row seatbacks anti-clockwise through 90 degrees to release the carpeted cover.
2. Fold it forwards to cover up the folded seats.
3. To fix the cover back onto the seatbacks, fold it back and push the retainers into the seatback until they click into place.

Note: When only the third row seats are folded flat, fold the covers forwards to cover up the base of the second row seats. The smaller flaps at the front of the cover should stand vertically against the second row seatbacks.

Seats

HEATED SEATS

CAUTION

⚠ Operating this function with the engine off will drain the battery.



E70601

VENTILATED SEATS

CAUTION

⚠ Operating this function with the engine off will drain the battery.



E70601

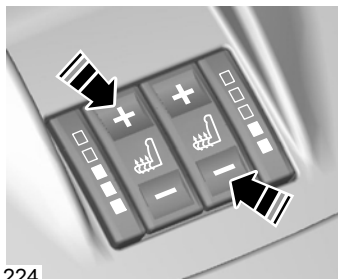

E71224

Note: The settings are stored when you switch off the ignition.

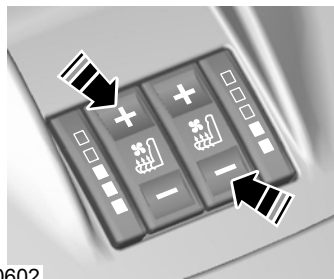

E70602

Note: The settings are stored when the ignition is switched off.

Note: When the seat is being ventilated, the heater may switch on automatically. This is to prevent the flow of air becoming uncomfortably cool.

Seats

Note: The air in the vehicle interior is used to ventilate the seats. The cooling effect therefore depends on the temperature of the vehicle interior. Switch on the air conditioning if necessary and set the air distribution to footwell. See **Climate control** (page 104).

FRONT SEAT ARMREST

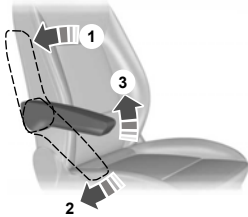

E95256

Convenience features

SUN BLINDS

Side windows

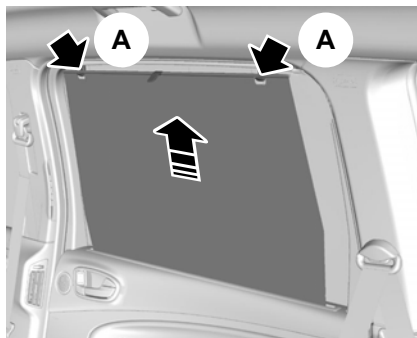

E74809

Pull the blind up and attach it to the hooks (A).

Roof (S-Max)

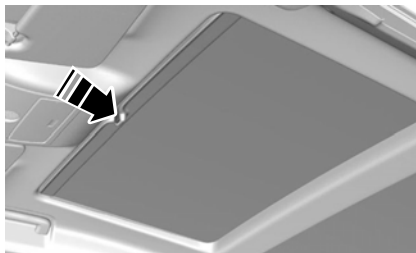

E74807

To release the blind, press the button.

INSTRUMENT LIGHTING DIMMER



E70723

CLOCK

Note: Some navigation systems will automatically set the date and time on the clock using GPS signals.

Note: See **General information** (page 82).



1. From the main menu, select the clock function.
2. Select the option required.
3. Press **OK**.

Convenience features

- Using the right, left, up and down arrow buttons, select and change the value.
- Press **OK**.

CIGAR LIGHTER

CAUTIONS

-  If you use the socket when the engine is not running, the battery may discharge.
-  Do not hold the cigar lighter element pressed in.

Note: Switch the ignition on to use the cigar lighter. You can also use it for up to 30 minutes after you have switched the ignition off.

Note: You can use the socket to power 12 volt appliances that have a maximum current rating of 15 Amperes. Use only Ford accessory connectors or connectors specified for use with SAE standard sockets.

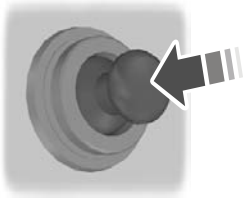

E72972

Press the element in to use the cigar lighter. It will pop out automatically.

ASHTRAY

Front ashtray

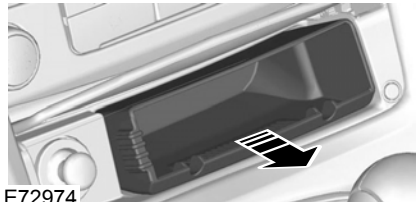

E72974

To empty, pull out the complete ashtray.

Rear ashtray



E73705

To remove the ashtray, open it, press it down against the spring and remove it.

AUXILIARY POWER SOCKETS

CAUTION

-  If you use the socket when the engine is not running, the battery may discharge.

Note: You can use the socket when the ignition is switched off.

Convenience features

Note: You can use the socket to power 12 volt appliances that have a maximum current rating of 15 Amperes. Use only Ford accessory connectors or connectors specified for use with SAE standard sockets.

S-Max



E74130

Galaxy



E72977

CUP HOLDERS

WARNING

 Do not place hot drinks in the cup holders when the vehicle is moving.

Seat back trays

WARNING

 Do not use the trays when the vehicle is moving. Make sure that you secure the trays in the lowered position before setting off.



E72630

GLOVE BOX

Cooled glove box

Note: You can cool the glove box using air from the air conditioning system.

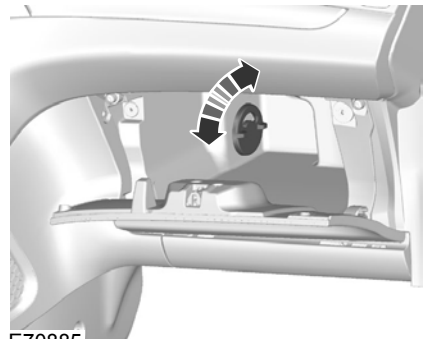

E70885

Convenience features

STORAGE COMPARTMENTS

WARNING

 Do not drive with any storage compartment lid open. Make sure that you secure the lid before setting off.

CAUTION

 Do not keep heat-sensitive items and liquids in any storage compartment.

Front storage compartments

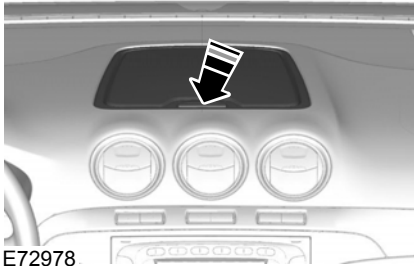

E72978



E72980

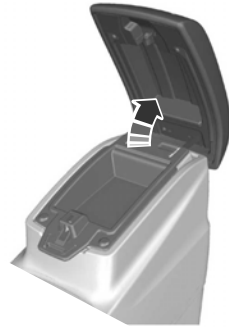

E73704

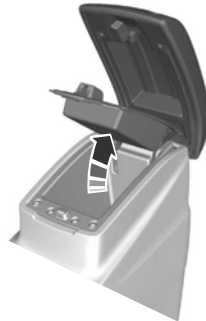

E72905

Convenience features

Under seat storage compartment

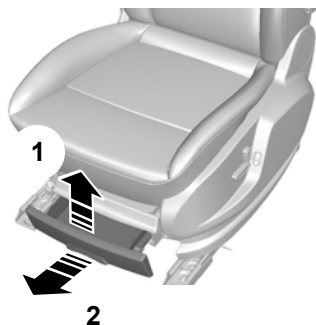

E72981

Overhead storage compartments

WARNING



Do not place heavy objects in the overhead storage compartments.

CAUTION



Do not exceed the maximum permissible loads of 1 kilogramme (2.2 pounds) for the smaller compartment and 2 kilogrammes (4.4 pounds) for the larger compartment.

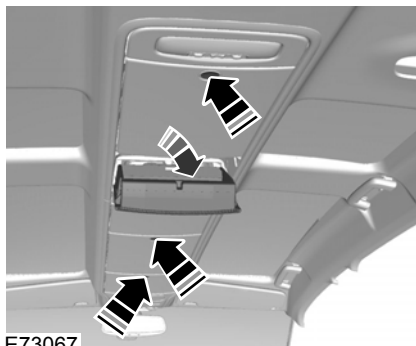

E73067

Rear storage compartment

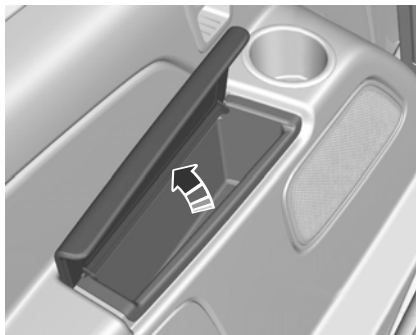

E72982

Convenience features

Under floor storage compartment

WARNING

 When you are using a child restraint with a support leg on a second row seat, make sure that you locate the support leg securely on the under floor storage compartment lid. Make sure that you install the foam spacer correctly inside the storage compartment and that you position the lid correctly.

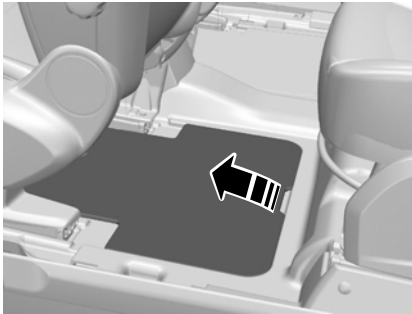

E72585

MAP POCKETS

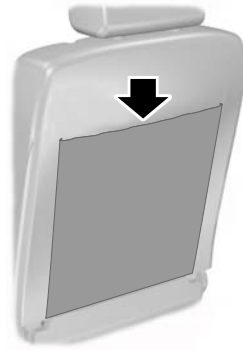

E74686

SEAT BACK TRAYS

WARNING

 Do not use the trays when the vehicle is moving. Make sure that you secure the trays in the lowered position before setting off.

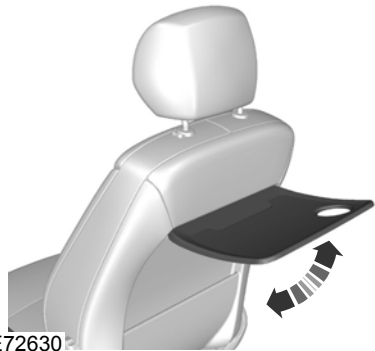

E72630

Convenience features

GLASSES HOLDER

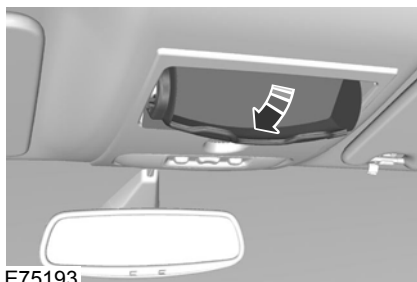

E75193

MEMORY FUNCTION

WARNINGS



Before activating the seat memory, make sure that the area immediately surrounding the seat is clear of obstructions and that all occupants are clear of moving parts.



Do not use the memory store function when the vehicle is moving.

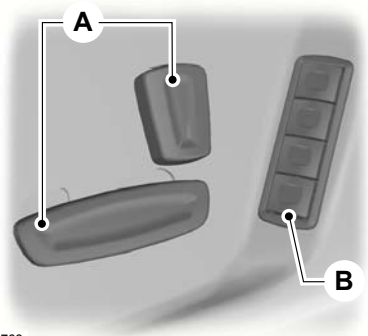

E86768

A Seat adjustment controls. See **Electric seats** (page 119).

B Memory pre-set buttons

Up to four different driver's seat and exterior mirror positions can be stored in the memory. Your preferred setting for the reverse mirror dipping feature can also be stored. See **Electric exterior mirrors** (page 73).

Setting a memory pre-set

Passive setting

The vehicle stores the seating and mirror positions for up to four remote controls or passive keys. Next time the vehicle is unlocked, the position of the seat and mirrors will adjust to the last used position.

Each time you turn the ignition off, the current seat and mirror settings are stored on the remote control or passive key used.

Active setting

1. Turn the ignition on.
2. Adjust the seat and exterior mirrors to the desired position.

Convenience features

- Press and hold the desired pre-set button **B** until a single chime sounds to confirm.

Recalling a stored seat position

Note: To stop seat movement during a recall, press any driver seat adjustment control, any of the memory buttons or any mirror control switch. Seat movement will also stop if you move the vehicle.

Passive recall

Note: If more than one passive key is in range, the memory function will move to the settings of the first key stored.

When you unlock the vehicle with the remote control or pull the driver door handle with a passive key in range, the seat and mirrors will move to the position stored on that remote control or passive key.

Active recall

Press the pre-set button associated with the desired driving position. The seat and mirrors will move to the position stored on that pre-set.

CHILDMINDER MIRROR



E75192

CD CHANGER

This is located under the front passenger seat.

AUXILIARY INPUT (AUX IN) SOCKET

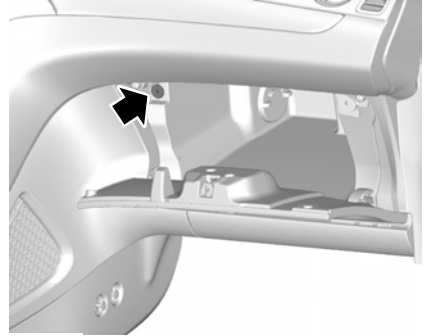

E71969

See separate audio handbook.

Convenience features

USB PORT

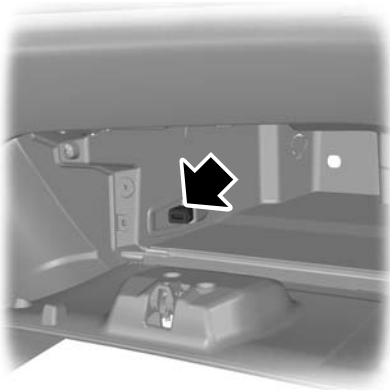

E104423

See **Connectivity** (page 271).

Starting the engine

GENERAL INFORMATION

General points on starting

If the battery has been disconnected the vehicle may exhibit some unusual driving characteristics for approx. 8 kilometres (5 miles) after reconnecting the battery.

This is because the engine management system must realign itself with the engine. Any unusual driving characteristics during this period may be disregarded.

Starting the engine by towing or pushing

WARNING



To prevent damage you must not push or tow start your vehicle. Use booster cables and a booster battery. See **Using booster cables** (page 222).

IGNITION SWITCH

WARNING



Never return the key to the **O** position when the vehicle is in motion.



E72128

O The ignition is off.

I The ignition and all main electrical circuits are disabled.

Note: Do not leave the ignition key in this position for too long to avoid discharging the battery.

II The ignition is switched on. All electrical circuits are operational. Warning lamps and indicators illuminate. This is the key position when driving. You must also select it when being towed.

III The starter motor is activated. Release the key as soon as the engine starts.

STEERING WHEEL LOCK

WARNING



Always check that the steering is unlocked before attempting to move your vehicle.

Vehicles without keyless starting

To activate the steering wheel lock;

1. Remove the key from the ignition switch.
2. Turn the steering wheel.

Vehicles with keyless starting

Your vehicle has an electronically controlled steering wheel lock. This operates automatically.

The steering wheel lock is activated if the ignition is off, the engine not running and your vehicle is stationary.

The steering wheel lock is deactivated when the ignition is switched on.

STARTING A PETROL ENGINE

Note: You can only operate the starter for a maximum of 30 seconds at a time.

Starting the engine

Cold or hot engine

All vehicles

CAUTION

 When the temperature is below -20°C (-4°F), switch the ignition on for at least one second before starting the engine. This will make sure that the maximum fuel pressure is established for starting the engine.

Vehicles with manual transmission

Note: *Do not touch the accelerator pedal.*

1. Fully depress the clutch pedal.
2. Start the engine.

Vehicles with automatic transmission

Note: *Do not touch the accelerator pedal.*

1. Select park or neutral.
2. Fully depress the brake pedal.
3. Start the engine.

All vehicles

If the engine does not start within 15 seconds, wait for a short period and try again.

If the engine does not start after **three** attempts, wait 10 seconds and follow the **Flooded engine** procedure.

If you have difficulty starting the engine when the temperature is below -25°C (-13°F), press the accelerator pedal between ¼ to ½ of its travel and try again.

Flooded engine

Vehicles with manual transmission

1. Fully depress the clutch pedal.

2. Fully depress the accelerator pedal and hold it there.
3. Start the engine.

Vehicles with automatic transmission

1. Select park or neutral.
2. Fully depress the accelerator pedal and hold it there.
3. Fully depress the brake pedal.
4. Start the engine.

All vehicles

If the engine does not start, repeat the **Cold or hot engine** procedure.

Engine idle speed after starting

The speed at which the engine idles immediately after starting will vary depending on the engine temperature.

If the engine is cold then the idle speed will automatically be increased in order to heat the catalytic converter as quickly as possible. This ensures that vehicle emissions are kept to an absolute minimum.

The idle speed will slowly decrease to the normal level as the catalytic converter warms up.

STARTING A PETROL ENGINE - E85

For general information on starting a petrol engine. See **Starting a petrol engine** (page 137).

Starting the engine

Starting at low ambient temperatures

When the temperature is lower than -10°C (14°F) and the vehicle is filled with E85, an engine block heater should be used to facilitate starting. See **Engine heater** (page 140). Failure to do this will result in a non start.

If the temperature is expected to remain below -10°C (14°F), it is recommended that you increase the proportion of petrol in the tank by topping up with 95 octane unleaded petrol if the tank is not already full. About 10 litres (2.2 gallons) of petrol will reduce the proportion of E85 in a $\frac{3}{4}$ full tank from 85% to 70% and will considerably improve cold start capability.

If, at very low temperatures, the tank is filled with only E85 and there is no way to use an engine block heater, you may experience difficulties starting the engine.

If the engine fails to start, proceed as follows:

1. Fully depress the accelerator pedal.
2. Turn the ignition key to position III.

CAUTION



Release the ignition key as soon as the engine has started.

3. Gradually release the accelerator pedal after 5 seconds of engine cranking or as the engine speed rises.

If the engine fails to start, repeat steps 1, 2 and 3, or connect an engine block heater for two hours before attempting another start.

During starting, the fuel injectors are turned off as long as the accelerator pedal is depressed. This can be used to drain excessive fuel from the intake manifold after several unsuccessful starting attempts.

If the battery has been disconnected or after the fuel type has been changed, the idle speed may be irregular. This will improve after 10 to 30 seconds.

STARTING A DIESEL ENGINE

Cold or hot engine

All vehicles

Note: When the temperature is below -15°C (5°F), you may need to crank the engine for up to 25 seconds. If you consistently operate the vehicle in such temperatures, we recommend that you have an engine block heater fitted.

Note: Continue cranking the engine until it starts.

Note: You can only operate the starter for a maximum of 30 seconds at a time.



Switch the ignition on and wait until the glow plug indicator goes off.

Vehicles with manual transmission

Note: Do not touch the accelerator pedal.

1. Fully depress the clutch pedal.
2. Start the engine.

Vehicles with automatic transmission

1. Select park or neutral.
2. Fully depress the brake pedal.
3. Start the engine.

Starting the engine

DIESEL PARTICULATE FILTER (DPF)

The DPF forms part of the emissions reduction systems fitted to your vehicle. It filters harmful diesel particulates (soot) from the exhaust gas.

Regeneration

WARNING



Do not park or idle your vehicle over dry leaves or dry grass or other combustible material. The regeneration process requires very high exhaust gas temperatures and the exhaust will radiate a considerable amount of heat during and after regeneration, and after you have switched the engine off. This is a potential fire hazard.

Unlike a normal filter which requires periodic replacement, the DPF has been designed to regenerate, or clean itself to maintain operating efficiency. The regeneration process takes place automatically. However, some driving conditions mean that you may need to support the regeneration process.

If you drive only short distances or your journeys contain frequent stopping and starting, occasional trips with the following conditions could assist the regeneration process:

- Drive your vehicle, preferably on a main road or motorway, for up to 20 minutes avoiding prolonged idling, but always observing speed limits and road conditions.
- Do not switch off the ignition.
- Use a lower gear than normal to maintain a higher engine speed during this journey, where appropriate.

SWITCHING OFF THE ENGINE

Vehicles with a turbocharger

CAUTION



Do not switch the engine off when it is running at high speed. If you do, the turbocharger will continue running after the engine oil pressure has dropped to zero. This will lead to premature turbocharger bearing wear.

Release the accelerator pedal. Wait until the engine has reached idle speed and then switch it off.

ENGINE HEATER

CAUTION



Make sure you disconnect the power cable from the engine heater connector before driving away.

Note: *The engine heater connector is located in the radiator grille at the front of your vehicle.*

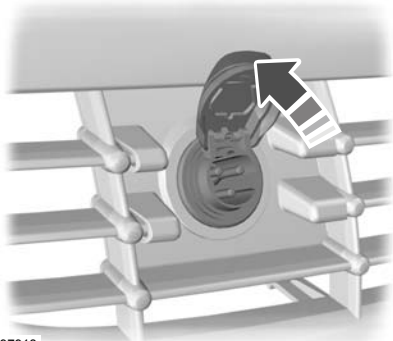

E97918

Connect the engine heater for 2 to 3 hours before starting the engine.

Fuel and refuelling

SAFETY PRECAUTIONS

WARNINGS



Stop refuelling after the fuel nozzle stops the second time. Additional fuel will fill the expansion space in the fuel tank which could lead to fuel overflowing. Fuel spillage could be hazardous to other road users.



Do not use any kind of flames or heat near the fuel system. The fuel system is under pressure. There is a risk of injury if the fuel system is leaking.

FUEL QUALITY - PETROL

Note: We recommend that you use only high quality fuel without additives or other engine treatments.

CAUTION



Do not use leaded petrol or petrol with additives containing other metallic compounds (e.g. manganese-based). They could damage the emission system.

Use **minimum 95 octane unleaded** petrol that meets the specification defined by **EN 228**, or equivalent.

FUEL QUALITY - E85

WARNINGS



Do not modify the fuel system configuration or the components in the system.



Do not replace the fuel system or the components with parts not specially designed to be used with E85.

CAUTIONS



Do not use leaded petrol or petrol with additives containing other metallic compounds (e.g. manganese-based). They could damage the emission system.



Do not use methanol instead of E85.

Note: We recommend that you use only high quality fuel without additives or other engine treatments.

Note: When using E85, you may experience a higher fuel consumption.

Note: The correct fuel type for your vehicle is shown on a decal on the inside of the fuel filler flap.

Note: Your vehicle will operate well on commercial quality 95 octane unleaded petrol, but only high quality E85 offers the same protection and performance.

Use **minimum 95 octane unleaded** petrol that meets the specification defined by **EN 228**, or equivalent. You can also use a mixture of unleaded petrol and E85.

Long-term storage

Due to small amounts of corrosive impurities that may be found in the E85, it is recommended that you fill the tank with only 95 octane unleaded petrol prior to long-term storage of your vehicle.

FUEL QUALITY - DIESEL

Note: We recommend that you use only high quality fuel without additives or other engine treatments.

Fuel and refuelling

WARNING



Do not mix diesel with oil, petrol or other liquids. This could cause a chemical reaction.

CAUTION



Do not add kerosene, paraffin or petrol to diesel. This could cause damage to the fuel system.

Note: We do not recommend the prolonged use of additives intended to prevent fuel waxing.

Use diesel that meets the specification defined by **EN 590**, or equivalent.

You can use diesel that contains up to 5% RME (bio diesel).

CATALYTIC CONVERTER

Driving with a catalytic converter

CAUTIONS



Avoid running out of fuel.



Do not crank the engine for long periods.



Do not run the engine when a spark plug lead is disconnected.



Do not push-start or tow-start your vehicle. Use booster cables. See **Using booster cables** (page 222).



Do not switch the ignition off when driving.

Parking

WARNING



Do not park your vehicle over dry leaves or dry grass. The exhaust will continue to radiate a considerable amount of heat after you have switched the engine off. This is a potential fire hazard.

FUEL FILLER FLAP

Note: Central locking also locks and unlocks the fuel filler flap. See **Locking and unlocking** (page 37).

Note: It is normal to hear a hissing noise when you remove the filler cap.

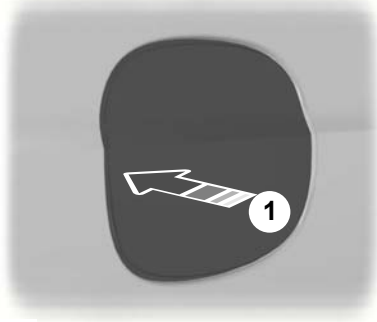

E94744

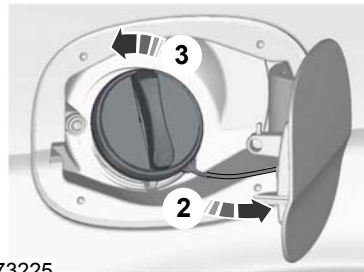

E73225

Fuel and refuelling

To close, turn the cap clockwise until it clicks.

REFUELLING

CAUTION

 Do not attempt to start the engine if you have filled the fuel tank with the incorrect fuel. This could damage the engine. Have the system checked by a properly trained technician immediately.

REFUELLING - E85

CAUTION

 Do not attempt to start the engine if you have filled the fuel tank with the incorrect fuel. This could damage the engine. Have the system checked by a properly trained technician immediately.

After refuelling, allow 5 minutes of normal engine operation above 48 km/h (30 mph) to reduce the risk of an increased engine restart time.

FUEL CONSUMPTION

The CO₂ and fuel consumption figures are derived from laboratory tests according to EEC Directive 80/1268/EEC and subsequent amendments and are carried out by all vehicle manufacturers.

They are intended as a comparison between makes and models of vehicles. They are not intended to represent the real world fuel consumption you may get from your vehicle. Real world fuel consumption is governed by many factors including; driving style, high speed driving, stop/start driving, air conditioning usage, the accessories fitted and towing etc.

Your Ford dealer can give you advice on improving your fuel consumption.

TECHNICAL SPECIFICATIONS

S-MAX

Fuel consumption figures

| Variant | Urban | Extra-urban | Combined | CO ₂ emissions |
|--|----------------|----------------|----------------|---------------------------|
| | l/100 km (mpg) | l/100 km (mpg) | l/100 km (mpg) | g/km |
| 2.0L Duratec | 11.0 (25.7) | 6.4 (44.1) | 8.1 (34.9) | 194 |
| 2.3L Duratec-HE (161 PS), 6-speed automatic transmission | 13.7 (20.6) | 7.4 (38.2) | 9.7 (29.1) | 232 |
| 2.5L Duratec, Durashift 6-speed manual transmission | 13.3 (21.2) | 7.1 (39.8) | 9.4 (30.1) | 224 |

Fuel and refuelling

| Variant | Urban | Extra-urban | Combined | CO2 emissions |
|---|----------------|----------------|----------------|---------------|
| | l/100 km (mpg) | l/100 km (mpg) | l/100 km (mpg) | g/km |
| 1.8L Duratorq-TDCi | 7.9 (35.8) | 5.2 (54.3) | 6.2 (45.6) | 164 |
| 2.0L Duratorq-TDCi, Durashift 6-speed manual transmission | 7.7 (36.7) | 5.0 (56.5) | 6.0 (47.1) | 159 |
| 2.0L Duratorq-TDCi (136 PS), 6-speed automatic transmission | 9.7 (29.1) | 5.7 (49.6) | 7.2 (39.2) | 189 |
| 2.2L Duratorq-TDCi, Durashift 6-speed manual transmission | 9.0 (31.4) | 5.2 (54.3) | 6.6 (42.8) | 176 |

Galaxy

Fuel consumption figures

| Variant | Urban | Extra-urban | Combined | CO2 emissions |
|---|----------------|----------------|----------------|---------------|
| | l/100 km (mpg) | l/100 km (mpg) | l/100 km (mpg) | g/km |
| 2.0L Duratec | 11.2 (25.2) | 6.5 (43.5) | 8.2 (34.5) | 197 |
| 2.3L Duratec-HE (161 PS), 6-speed automatic transmission | 13.8 (20.5) | 7.5 (37.7) | 9.8 (28.8) | 235 |
| 1.8L Duratorq-TDCi (125 PS), Durashift 6-speed manual | 8.0 (35.3) | 5.3 (53.3) | 6.3 (44.8) | 166 |
| 1.8L Duratorq-TDCi | 8.0 (35.3) | 5.2 (54.3) | 6.2 (45.6) | 165 |
| 2.0L Duratorq-TDCi, Durashift 6-speed manual transmission | 7.7 (36.7) | 5.0 (56.5) | 6.0 (47.1) | 159 |
| 2.0L Duratorq-TDCi (136 PS), 6-speed automatic transmission | 9.7 (29.1) | 5.7 (49.6) | 7.2 (39.2) | 189 |

Fuel and refuelling

| Variant | Urban | Extra-urban | Combined | CO2 emissions |
|---|----------------|----------------|----------------|---------------|
| | l/100 km (mpg) | l/100 km (mpg) | l/100 km (mpg) | g/km |
| 2.2L Duratorq-TDCi, Durs-hift 6-speed manual transmission | 9.1 (31.0) | 5.3 (53.3) | 6.7 (42.2) | 179 |

Transmission

MANUAL TRANSMISSION

All vehicles

CAUTIONS

- ⚠ Do not engage reverse gear when the vehicle is moving. This can cause damage to the transmission.
- ⚠ Do not apply any undue lateral force to the gear lever when changing from 5th to 4th gear. This could lead to the inadvertent selection of 2nd gear and can cause damage to the transmission.

Selecting reverse gear

On some vehicles it is necessary to raise the collar whilst selecting reverse gear.

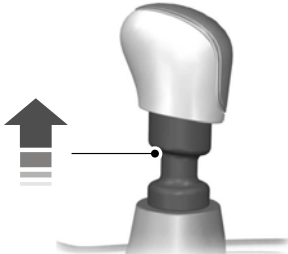

E99067

AUTOMATIC TRANSMISSION

Selector lever positions



E80836

- P Park
- R Reverse
- N Neutral
- D Drive
- S Sport mode and manual shifting

WARNING

- ⚠ Apply the brakes before moving the selector lever and keep them applied until you are ready to move off.

Note: A cold engine has a higher idle speed. This will increase the tendency for your vehicle to **creep** when you have selected a drive gear.

Press the button on the selector lever to select reverse and park.

The selector lever position will be shown in the information display.

Transmission

Park

WARNINGS



Select park only when your vehicle is stationary.



Apply the parking brake and select park before leaving your vehicle. Make sure that the selector lever is latched in position.

Note: An audible warning will sound if you open the driver's door and you have not selected park.

In this position, power is not transmitted to the drive wheels and the transmission is locked. You can start the engine with the selector lever in this position.

Reverse

WARNING



Select reverse only when your vehicle is stationary and the engine is at idle speed.

Neutral

In this position, power is not transmitted to the drive wheels but the transmission is not locked. You can start the engine with the selector lever in this position.

Drive

Select drive to shift automatically through the forward gears.

Sport mode and manual shifting

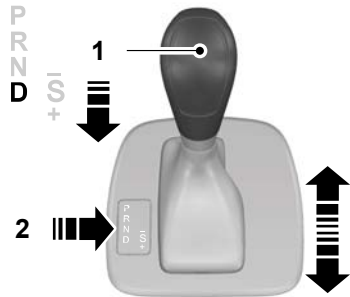

E80837

Note: A shift will occur only when the vehicle speed and the engine speed are appropriate.

Note: When you select position **S**, a gear change may occur depending on the accelerator pedal position in relation to actual vehicle speed.

Activate sport mode by moving the selector lever to position **S**. Sport mode will remain active until you shift manually up or down the gears.

Select manual shifting to shift manually through the forward gears. Push the selector lever forwards to shift down and pull it backwards to shift up.

Drive modes

The transmission will select the appropriate gear for optimum performance based on ambient temperature, road gradient, vehicle load and driver input.

Hints on driving with an automatic transmission

Moving off

1. Release the parking brake.

Transmission

2. Release the brake pedal and press the accelerator pedal.

Stopping

1. Release the accelerator pedal and press the brake pedal.
2. Apply the parking brake.

Kickdown

Press the accelerator pedal fully with the selector lever in the drive position to select the next lowest gear for optimum performance. Release the accelerator pedal when you no longer require kickdown.

Emergency park position release lever

Use the lever to move the selector lever from the park position in the event of an electrical malfunction or if your vehicle has a flat battery.

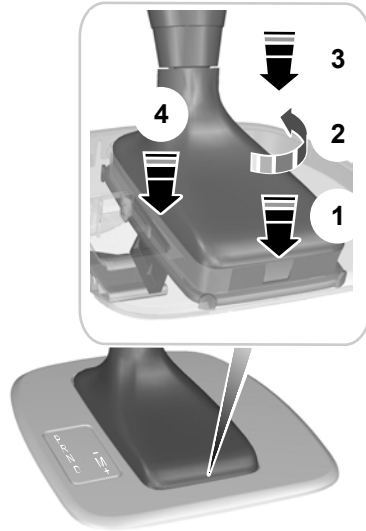

E81705

1. Insert a flat-bladed screwdriver into the slot.
2. Turn the screwdriver through 90 degrees.
3. Push downwards on the screwdriver to detach the gaiter frame from the trim panel.
4. Push downwards on the gaiter frame to release the lever and move the selector lever from the park position.
5. Pull upwards on the gaiter until the gaiter frame engages in the trim panel.

Brakes

PRINCIPLE OF OPERATION

Disc brakes

Wet brake discs result in reduced braking efficiency. Dab the brake pedal when driving from a car wash to remove the film of water.

ABS

WARNING



The ABS does not relieve you of your responsibility to drive with due care and attention.

The ABS helps you to maintain full steering and directional stability when you brake heavily in an emergency, by preventing the road wheels from locking.

HINTS ON DRIVING WITH ABS

When the ABS is operating, the brake pedal will pulse. This is normal. Maintain pressure on the brake pedal.

The ABS will not eliminate the dangers inherent when:

- you drive too close to the vehicle in front of you.
- the vehicle is aquaplaning.
- you take corners too fast.
- the road surface is poor.

PARKING BRAKE

Applying the parking brake

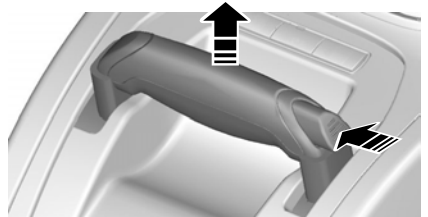
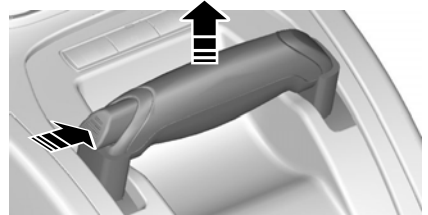

E73224

WARNING



Make sure that the parking brake is applied before you release the lever.

Note: Do not press the release button when you apply the parking brake.

1. Press the brake pedal firmly.
2. Pull the parking brake lever upwards to its fullest extent.

Brakes

Parking on a hill

If you have to park facing uphill, select first gear and turn the front wheels away from the kerb. If you have to park facing downhill, select reverse gear and turn the front wheels towards the kerb.

Releasing the parking brake

1. Press the brake pedal firmly.
2. Pull the parking brake lever upwards slightly, press the release button and push the lever downwards.

ELECTRIC PARKING BRAKE (EPB)

The electric parking brake (EPB) replaces the conventional handbrake. It is operated by a switch located in the centre console.

WARNINGS



Always apply the EPB and select first or reverse gear before leaving the vehicle.



Vehicles with automatic transmission should always be left with the selector lever in position **P**.

Note: Under certain conditions for example on a steep hill, when the vehicle has been parked with the EPB applied, the EPB performs an automatic re-clamp function. This will occur approximately three minutes after the EPB has been applied.

Note: You may notice various noises when the EPB is applied and released. This is normal and no cause for concern.

Parking on a hill

If you have to park facing uphill, select first gear and turn the front wheels away from the kerb. If you have to park facing downhill, select reverse gear and turn the front wheels towards the kerb.

Applying the EPB

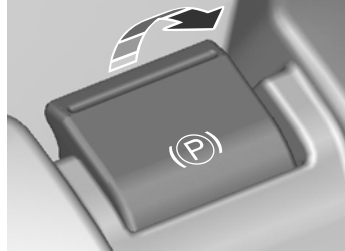

E70528

Pull up the switch once to apply the EPB.

The brake system warning lamp illuminates to confirm that the EPB is now applied.

Note: The brake system warning lamp will remain illuminated for a short period if you turn the ignition to position **O** or remove the key.

Automatic application of the EPB

WARNING



The EPB will not automatically apply on vehicles with a keyless start or keyless entry system. You must apply the EPB using the EPB switch.

When you turn the ignition off, the cluster will remain on for several minutes.

The EPB will automatically apply when you remove the key from the ignition during this period.

Brakes

Preventing automatic application of the EPB

WARNINGS

 Do not leave the vehicle if you have not applied the EPB. Remember that if you press down the switch while removing the key from the ignition (on vehicles with a keyless entry system, when pulling the ignition switch out), the EPB will not be applied.

 Make sure that the vehicle's wheels are securely wedged if you park the vehicle with the EPB released to prevent it from rolling away.

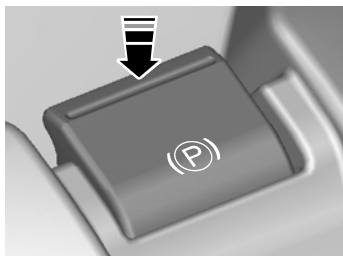

E70529

Hold the switch pressed while you switch off the ignition or while you remove the key from the ignition.

WARNING

 If you prevented the EPB from applying while turning off the ignition, it will remain off when you remove the key.

Applying the EPB when the vehicle is moving

WARNING

 With the exception of emergency conditions (for example, the brake pedal does not work or is blocked), do not apply the EPB while the vehicle is moving. On bends, on poor road surfaces or weather conditions, emergency braking can cause the vehicle to skid out of control or off the road.

If you apply the EPB while the vehicle is moving, the brake system warning lamp illuminates and a warning chime will sound.

At speeds above 6 km/h (4 mph), the braking force is applied as long as you hold the switch in the on position. The EPB will be applied until you release or press down the switch, or press the accelerator pedal further.

Releasing the EPB

Automatic release - drive away release (DAR)

Note: *On vehicles with automatic transmission, the driver's door must be closed and the driver's seatbelt must be fastened before the DAR will operate.*

Note: *If the EPB warning lamp stays illuminated the EPB will not automatically release. You must release the EPB using the EPB switch.*

Note: *The engine must be running and the accelerator pedal must be pressed before the DAR will operate.*

Note: *The clutch pedal must be fully depressed before the DAR will operate.*

Engage first or reverse gear, move off as normal using the accelerator and clutch pedals and the EPB will be automatically released.

Brakes

The brake system warning lamp will go off to confirm that the EPB has been released.

Note: *On vehicles with manual transmission, if the gear lever is in neutral when you release the clutch pedal and depress the accelerator pedal, the EPB will be released automatically.*

Note: *The EPB also makes moving off on a slope easier and prevents the vehicle from rolling in an undesired direction. The brakes are released automatically once the clutch is engaged and the engine has developed sufficient drive to prevent the vehicle from rolling down the slope. This is an advantage when pulling away on a slope, for example from a car park ramp, traffic lights or when reversing uphill into a parking space.*

Manual release

Note: *To release the EPB, the ignition must be in position II.*

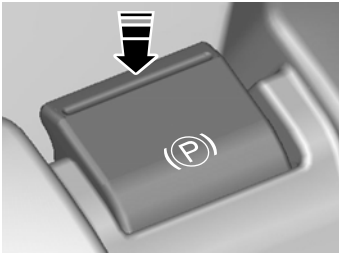

E70529

Hold the brake pedal depressed and press down the switch.

The brake system warning lamp will go off to confirm that the EPB has been released.

Moving off with a trailer (vehicles with manual transmission)

Depending on the gradient and the weight of the trailer, the vehicle and trailer may roll backwards slightly when you move off on a slope. To prevent this happening, deactivate the DAR and release the EPB manually as follows:

1. Pull up the switch and hold it in this position.
2. Move off as normal and then press down the switch when you notice that the engine has developed sufficient driving force.

Cut in the power supply

WARNING



You will not be able to apply or release the EPB if there is a cut in the power supply, for example a flat battery, failure of the alternator or vehicle electronics.

If the battery is flat, use booster cables and a booster battery. See **Using booster cables** (page 222).

Stability control

PRINCIPLE OF OPERATION

Electronic stability programme (ESP)

WARNING



ESP does not relieve you of your responsibility to drive with due care and attention.

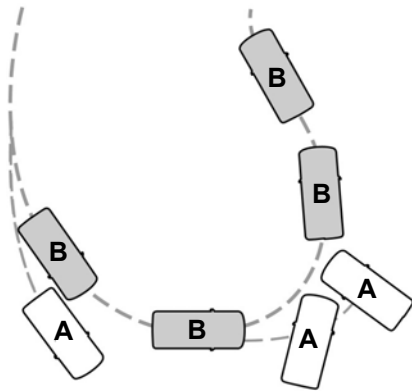

E72903

- A without ESP
- B with ESP

The ESP supports stability when the vehicle starts to slide away from your intended path. This is performed by braking individual wheels and reducing engine torque as needed.

The system also provides an enhanced traction control function by reducing engine torque if the wheels spin when you accelerate. This improves your ability to pull away on slippery roads or loose surfaces, and improves comfort by limiting wheel spin in hairpin bends.

Stability control (ESP) warning lamp

The ESP warning lamp will flash when the system is operating. See **Warning lamps and indicators** (page 79).

Emergency brake assist

WARNING



Emergency brake assist does not relieve you of your responsibility to drive with due care and attention.

Emergency brake assist will detect when you brake heavily by measuring the rate at which you press the brake pedal. It will provide maximum braking efficiency as long as you press the pedal. Emergency brake assist can reduce stopping distances in critical situations.

USING STABILITY CONTROL



Press and hold the switch for one second. The switch will illuminate. A message will be shown in the display. See **Information messages** (page 95).

Press the switch again to turn the system on. The system will be switched on automatically every time you switch the ignition on.

Hill launch assist (HLA)

PRINCIPLE OF OPERATION

The hill launch assist (HLA) system makes it easier to pull away when the vehicle is on a slope without the need to use the parking brake.

When the HLA is active, the vehicle will remain stationary on the slope for two to three seconds after you release the brake pedal. During this time, you have time to move your foot from the brake to the accelerator pedal and pull away. The brakes are released automatically once the engine has developed sufficient drive to prevent the vehicle from rolling down the slope. This is an advantage when pulling away on a slope, for example from a car park ramp, traffic lights or when reversing uphill into a parking space.

WARNING



The HLA does not replace the parking brake. When you leave the vehicle, always apply the parking brake and select first or reverse gear.

USING HLA

The HLA can operate in either automatic or manual mode. If you select automatic mode, the HLA is activated automatically when the vehicle is on a slope and you press the brake pedal. If you select manual mode, you must activate the HLA using the brake pedal.

To set the HLA mode:

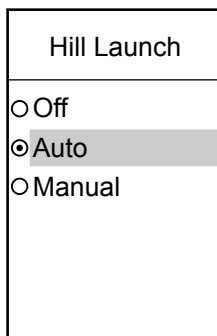

1. Press the right arrow button on the steering wheel to enter the main menu.
2. Highlight **Setup** with the up and down buttons and press the right arrow button.
3. Highlight **Hill Launch** and press the right arrow button.
4. Highlight the desired setting and press the **OK** button to confirm the setting. If **Off** is selected, the HLA is switched off and cannot be activated either automatically or manually.
5. Press the left arrow button to exit the menu. Hold the left arrow button pressed to return to the trip computer display.

Hill launch assist (HLA)

Note: When HLA is in manual activation mode, only use the HLA when pulling away uphill on gradients greater than 3%. If the vehicle is on the flat or on a downhill slope, an active HLA will make it difficult to pull away smoothly.

Activating the HLA

WARNINGS



You must remain in the vehicle once you have activated the HLA. Any attempt to leave the vehicle will deactivate the HLA automatically.



The HLA is active only if the message **Hill Launch Assist active** is displayed in the information display. During all times you are responsible for controlling the vehicle, supervising the HLA and intervening, if required.

You can activate the HLA only if the following conditions have been met:

- The engine is running.
- The HLA is switched on (automatic or manual mode).
- The parking brake or electric parking brake (EPB) is fully disengaged.
- On vehicles with manual transmission, the clutch pedal is pressed.
- On vehicles with automatic transmission, the driver's door is closed.
- No failure mode is present.

To activate the HLA in automatic mode:

1. Press the brake pedal to bring the vehicle to a complete standstill. Keep the brake pedal depressed.
2. If the sensors detect that the vehicle is on a slope and the right driving direction is selected (first gear if the vehicle is pointing uphill, reverse gear if the vehicle is pointing downhill), the HLA will be activated automatically.

Hill Launch Assist active is displayed in the information display.

3. When you remove your foot from the brake pedal, the vehicle will remain on the slope without rolling away for approximately two to three seconds.
4. Drive off in the normal manner. The brakes will be released automatically.

To activate the HLA in manual mode:

1. Press the brake pedal to bring the vehicle to a complete standstill. Keep the brake pedal depressed.
2. Quickly jab the brake pedal further until you hear a chime and **Hill Launch Assist active** is displayed in the information display. The HLA is now active.
3. When you remove your foot from the brake pedal, the vehicle will remain on the slope without rolling away for approximately two to three seconds.
4. Drive off in the normal manner. The brakes will be released automatically.

Hill launch assist (HLA)

WARNING



When HLA is active and the system detects a malfunction, the HLA is deactivated and the message

Please use park brake! followed by **Hill Launch A .not available** is displayed in the information display. The vehicle is still safe to be driven and can be repaired during the next service. The message **Hill Launch A. not available** is also displayed in the information display with manual activation during a malfunction or if one of the activation criteria is not met. If you have switched the HLA off, no messages will be displayed.

Deactivating the HLA

To deactivate the HLA, perform **one** of the following:

- Apply the parking brake or electric parking brake (EPB) .
- Wait for two to three seconds until the HLA deactivates automatically.
- If a forward gear was selected when the HLA became active, select reverse gear.
- If reverse gear was selected when the HLA became active, select a forward gear.

Hill Launch Assist off is displayed in the information display.

Active suspension

PRINCIPLE OF OPERATION

The active suspension provides improved handling, comfort and stability by continuously adjusting the damper properties to the current road and driving conditions. This system in conjunction with the ABS system offers the benefit of potentially shorter stopping distances on rough road surfaces.

Depending on your preferences and driving style, you can choose between three different settings:

Comfort

This provides a softer driving feel.

Normal

Normal setting.

Sport

This provides a harder, sportier ride.

USING ACTIVE SUSPENSION

Selecting a setting

Note: *After you select a setting, you may not immediately notice a difference in the vehicle's handling. The effect of the continuously controlled damping depends on the road surface and driving conditions.*

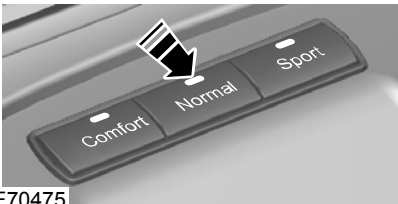

E70475

You can change the setting while driving.

System malfunction

The active suspension system will switch off automatically if it malfunctions. The suspension will be set to a fail-safe condition that will enable you to continue driving but you will not be able to change the suspension setting. Have this checked as soon as possible.

Parking aid

PRINCIPLE OF OPERATION

WARNING



The parking aid does not relieve you of your responsibility to drive with due care and attention.

CAUTIONS



Vehicles fitted with a trailer tow module not approved by us may not correctly detect obstacles.



The sensors may not detect objects in heavy rain or other conditions that cause disruptive reflections.



The sensors may not detect objects with surfaces that absorb ultrasonic waves.



The parking aid does not detect obstacles moving away from the vehicle. They will only be detected shortly after they start to move towards the vehicle again.



Take particular care when reversing with a tow ball arm or rear fitted accessories e.g. a bicycle carrier, as the rear parking aid will only indicate the distance from the bumper to the obstacle.



If you use a high pressure spray to wash your vehicle, only spray the sensors briefly from a distance not less than 20 centimetres (8 inches).

Note: On vehicles fitted with a tow ball arm, the parking aid is deactivated automatically when any trailer lamps (or lighting boards) are connected to the 13-pin socket via a trailer tow module we have approved.

Note: Keep the sensors free from dirt, ice and snow. Do not clean with sharp objects.

Note: The parking aid may emit false tones if it detects a signal using the same frequency as the sensors or if the vehicle is fully laden.

Note: The outer sensors may detect the side walls of a garage. If the distance between the outer sensor and the side wall remains constant for three seconds, the tone will switch off. As you continue, the inner sensors will detect rearward objects.

USING THE PARKING AID

Switching the parking aid on and off

Note: The parking aid switches off automatically when you start the engine or when you exceed 16 km/h (10 mph).

Note: The front and rear sensors are always activated or deactivated together.

The parking aid is per default off. To switch the parking aid on, press the switch in the instrument panel or select reverse gear.

The light in the switch illuminates when the parking aid is activated.

To turn it off, press the switch again.

Manoeuvring with the parking aid

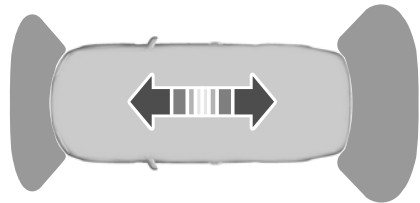

E72902

Parking aid

Note: *If a high pitch warning tone sounds for three seconds and the light in the switch is flashing, it indicates a malfunction. The system will be disabled. Have the system checked by properly trained technicians.*

You will hear an intermittent tone at a distance of up to approximately 150 centimetres (59 inches) between the obstacle and rear bumper, 80 centimetres (31 inches) between the obstacle and front bumper and 50 centimetres (20 inches) to the side. Decreasing the distance accelerates the intermittent tone. A continuous tone will start at a distance of less than 30 centimetres (12 inches).

You will hear an alternating tone from the front and rear if obstacles are closer than 30 centimetres (12 inches) to the front and rear bumpers.

Cruise control

PRINCIPLE OF OPERATION

Cruise control allows you to control your speed using the switches on the steering wheel. You can use cruise control when you exceed 30 km/h (20 mph).

USING CRUISE CONTROL

WARNING



Do not use cruise control in heavy traffic, on twisty roads or when the road surface is slippery.

Press the **SET+** switch or the **SET-** switch to store and maintain your current speed. The cruise control indicator illuminates.

Changing the set speed

WARNING



When you are going downhill, your speed may increase above the set speed. The system will not apply the brakes. Change down a gear and press the **RES** switch to assist the system in maintaining the set speed.

Switching cruise control on

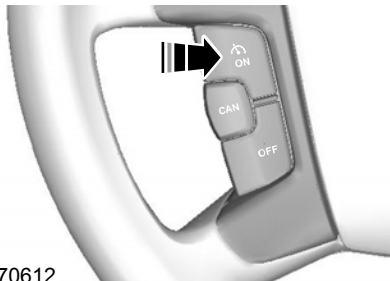

E70612

Setting a speed

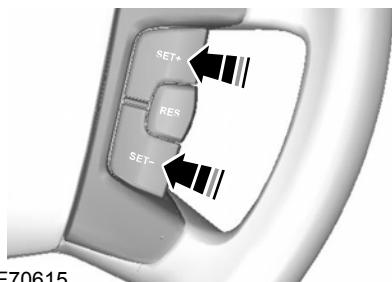

E70615

Note: If you accelerate by pressing the accelerator pedal, the set speed will not change. When you release the accelerator pedal, you will return to the speed that you previously set.

Press the **SET+** switch or the **SET-** switch to accelerate or decelerate.

Cancelling the set speed

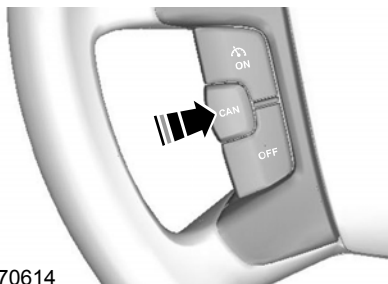

E70614

Press the brake pedal or the **CAN** switch. The system will no longer control your speed. The cruise control indicator will go off but the system will retain the speed that you previously set.

Cruise control

Resuming the set speed

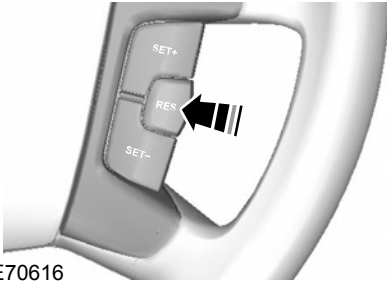

E70616

Press the **RES** switch. The cruise control indicator illuminates and the system will attempt to resume the speed that you previously set.

Switching cruise control off

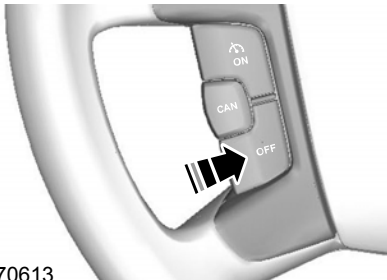

E70613

Press the **OFF** switch. The system will not retain the speed that you previously set. The cruise control indicator will go off.

Adaptive cruise control (ACC)

PRINCIPLE OF OPERATION

The adaptive cruise control system is designed to help you maintain a gap from the vehicle ahead or a set road speed if there is no slower vehicle ahead. The system is intended to provide enhanced operation of the vehicle when following other vehicles which are in the same lane and travelling in the same direction.

WARNINGS

 Adaptive cruise control is not a collision warning or avoidance system. The separate forward alert function provides a collision warning and mitigation feature. See **Forward alert function** (page 166). You must intervene if the system does not detect a vehicle in front.

 Adaptive cruise control cannot cover all traffic, weather and road conditions.

 When driving you are responsible for maintaining the correct distance and speed, even when adaptive cruise control is used. You must always pay attention to the traffic conditions and intervene when adaptive cruise control is not maintaining a suitable speed or suitable distance.

 The adaptive cruise control does not brake for slow or stationary vehicles.

 When ACC is activated, you may hear some unusual sounds during automatic braking. This is normal and caused by the automatic braking system.

The adaptive cruise control system is based on the use of a radar sensor which projects a beam directly forward of the vehicle. This beam will detect any vehicle ahead within the system's range.

The radar sensor is mounted behind the front grille, immediately to the right of the Ford badge (when viewed from the front of the vehicle).

When using ACC, follow the strict guidelines below:

- Only use adaptive cruise control when conditions are favourable, for example on motorways and main roads with steady free flowing traffic.
- Do not use in poor visibility, specifically fog, heavy rain, spray or snow.
- Do not use on icy or slippery roads.
- It is your responsibility to stay alert, drive safely and be in control of the vehicle at all times.
- Keep the front of the vehicle free from dirt, metal badges or objects, including vehicle front protectors and additional lights which may prevent the sensor from operating.
- Do not use ACC when entering or leaving a motorway.

The radar sensor has a limited field of vision. In some situations it may detect a vehicle other than the one expected or not detect any vehicle at all.

Adaptive cruise control (ACC)

Detection beam issues

A

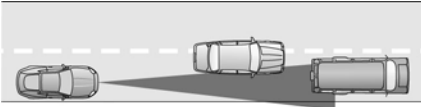

B



C

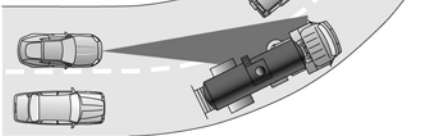

E71621 L

Detection issues can occur:

- When driving on a different line to the vehicle in front (**A**).
- With vehicles that edge into your lane that can only be detected once they have moved fully into your lane (**B**). Motorcycles may be detected late, or not at all.
- There may be issues with the detection of vehicles in front when going into and coming out of a bend (**C**). The detection beam will not follow sharp curves in the road.

WARNING



In these cases ACC may brake late or unexpectedly. The driver should stay alert and intervene if necessary.

Automatic braking with ACC

Adaptive cruise control will automatically brake for you, if required to maintain the set gap between your vehicle and the one detected in front. This braking capacity is limited to approximately 30% of the total manual braking capacity to ensure smooth and comfortable cruising. If the car needs to brake more heavily than this, and you do not intervene by braking manually, an alarm will sound and a warning symbol will be displayed in the cluster.

WARNING



You must take immediate action once alerted, as the ACC braking will not be sufficient to keep a safe distance to the vehicle in front.

USING ACC

The system is operated by adjustment controls mounted on the steering wheel. The system is deactivated when the brakes or clutch are used, the gear selector is moved to a neutral position or if the accelerator pedal is depressed for a longer period. The system will change to standby mode, allowing you full manual control of the vehicle.

Note: *If the accelerator is depressed for a short period, for example when overtaking, the system is temporarily deactivated and then reactivated when the accelerator pedal is released. **ACC override** is displayed in the information display.*

Adaptive cruise control (ACC)

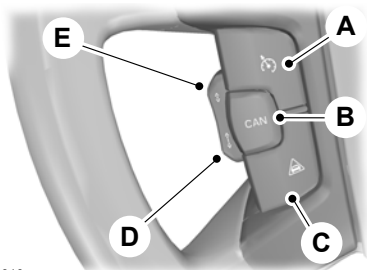

E82310

- A ACC on/off
- B ACC cancel
- C Forward alert on/off
- D ACC gap increase
- E ACC gap decrease

Switching ACC on

Press switch **A**. The system is set to standby mode and **Standby** is displayed in the information display.

Setting a speed

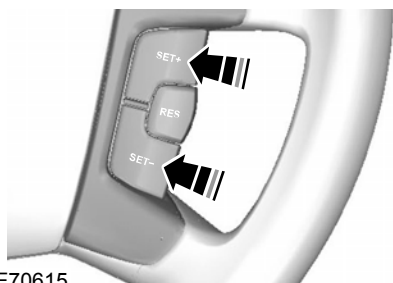

E70615

Note: The system must be in **Standby** mode.

Press the **SET+** switch or the **SET-** switch to select your desired cruise speed. The speed is displayed in the information display and stored as the set speed. The **ACC** indicator illuminates.

Note: Vehicle speed may be increased and decreased at intervals of 5 km/h or 5 mph. Smaller increases of 1 km/h or 1 mph may be set by pressing the **RES** switch.

Changing the set speed

Press the **SET+** switch or the **SET-** switch to accelerate or decelerate.

Note: If the system does not react to these changes the reason may be that the gap interval to the vehicle in front prevents an increase in speed.

Setting the vehicle gap

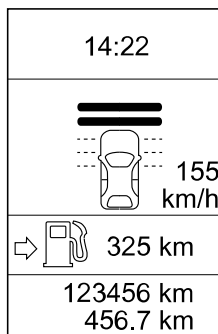

E82311

The distance between you and the vehicle detected in front is maintained by a variable setting. There are five steps which are represented by horizontal bars displayed in the information display. One bar denotes the smallest gap and five bars indicate the largest gap. These bars are shown empty when in standby mode and filled when in active mode.

Adaptive cruise control (ACC)

If no vehicle is detected in front, then only your vehicle is displayed in the information display below the bars. The system will maintain the set speed when conditions permit. The set gap is maintained and displayed.

If a vehicle is detected by the sensor, the display will show another vehicle above the horizontal bars:

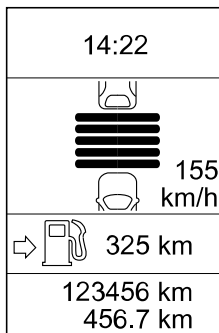

E82312

This is a follow mode, and the system will accelerate or decelerate as necessary to maintain the set gap.

Press switch **E** to decrease the gap or switch **D** to increase the gap. The gap selected will be represented by the number of bars in the display. The recommended gap setting is three to five bars.

Note: *The gap setting is time dependant and therefore the distance will automatically adjust with your speed. For example on a gap setting of three bars, the time gap is 1.8 seconds. This will mean that at a speed of 100 km/h (62 mph), the distance to the vehicle in front will be maintained at 50 metres (164 feet)*

CAUTION

 Use the appropriate gap setting in accordance with local traffic regulations.

Cancelling ACC

Press either the brake or clutch pedal, or switch **B**. The system will return to standby mode but will retain the set speed and gap in the memory. The **ACC** indicator will go off.

Resuming ACC

Press the **RES** switch. The **ACC** indicator illuminates and the system will resume with the previously set speed and vehicle gap setting if conditions permit.

Switching ACC off

Press switch **A**.

Note: *Pressing switch **A** does not return the system to standby mode. The stored speed is not retained.*

Note: *To temporarily deactivate the system press switch **B**.*

Automatic deactivation

The system is dependent on various other safety systems, for example ABS and ESP. If any of these systems are malfunctioning or reacting to an emergency, the system is automatically deactivated.

In the event of automatic deactivation a signal will sound and the message **ACC cancel** is displayed in the information display. You must then intervene and adapt your driving and speed to vehicles in front.

An automatic deactivation can be due to the:

Adaptive cruise control (ACC)

- vehicle speed falling below 30 km/h (20 mph)
- wheels lose traction
- brake temperature is high, for example when driving on mountainous or hilly roads
- engine speed is too low
- radar sensor is covered
- parking brake or electric parking brake (EPB) is applied.

If the engine speed drops too low, a message is displayed in the information display instructing you to change down a gear (manual transmission only). If you do not follow this recommendation then the system will go into automatic deactivation mode.

Note: *The system will not operate if the electronic stability programme (ESP) has been manually switched off.*

FORWARD ALERT FUNCTION

The system assists you by warning of the risk of a collision, and reducing the severity of a collision with a vehicle in front. This works by using two methods:

- You are alerted to a potential collision so you may brake earlier than normal.
- Brake support is activated to enable full braking effectiveness.

The collision alerts will only occur if the system is switched on, however the brake support is always on and cannot be turned off. Warnings are both visual and audible. Brake support is activated automatically if necessary to reduce the collision speed. The brake support system only reduces the collision speed if you brake immediately once alerted.

WARNINGS



Never wait for a collision warning. When driving you are responsible for maintaining the correct distance and speed, even when the system is used.



The system will only react to vehicles in front travelling in the same direction and will not react to slow or stationary vehicles.



Never drive in a manner to provoke the system. The system is designed to assist in emergencies only.

The system alerts you by warning chimes and a visual warning in the information display. When forward alert is activated a red flashing warning triangle is displayed in the information display.

Note: *You can deactivate the warning chimes by using the buttons on the steering wheel. See **Audible warnings and indicators** (page 81).*

The system does not operate in all driving situations and traffic, weather and road conditions.

The radar sensor detects vehicles in front that are driving in the same direction as you. If the risk of collision still increases after the initial warning then brake support is activated. Brake support prepares the brake system for rapid braking and the brakes are applied gently, which may be noticed as a slight jerk. If the brake pedal is depressed sufficiently quickly then braking is implemented with full brake function, even if the force on the pedal is light.

Adaptive cruise control (ACC)

CAUTION

! Warnings may be triggered late, be absent or triggered unnecessarily if the traffic situation means that the radar sensor cannot accurately detect a vehicle in front. The system uses the same radar sensors as adaptive cruise control (ACC) and therefore has the same limitations. See **Principle of operation** (page 162).

Note: *The system may be used with or without the ACC system being activated.*

Switching forward alert on/off

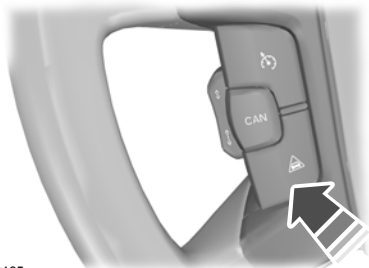

E94165

The indicator will illuminate.

Adjusting the warning sensitivity





You may adjust the system warning sensitivity using the buttons on the steering wheel. See **General information** (page 82).

This controls how early the visual and audible warning is activated.

Load carrying

GENERAL INFORMATION



WARNINGS

-  Use load securing straps to an approved standard, e.g. DIN.
-  Make sure that you secure all loose items properly.
-  Place luggage and other loads as low and as far forward as possible within the luggage or loadspace.
-  Do not drive with the tailgate or rear door open. Exhaust fumes may enter the vehicle.
-  Do not exceed the maximum front and rear axle loads for your vehicle. See **Vehicle identification** (page 238).

CAUTIONS

-  Do not allow items to contact the rear windows.

CAUTIONS

-  Do not use any abrasive materials to clean the interior of the rear windows.
-  Do not install stickers or labels to the interior of the rear windows.



E98626

Load carrying

LUGGAGE ANCHOR POINTS

Galaxy

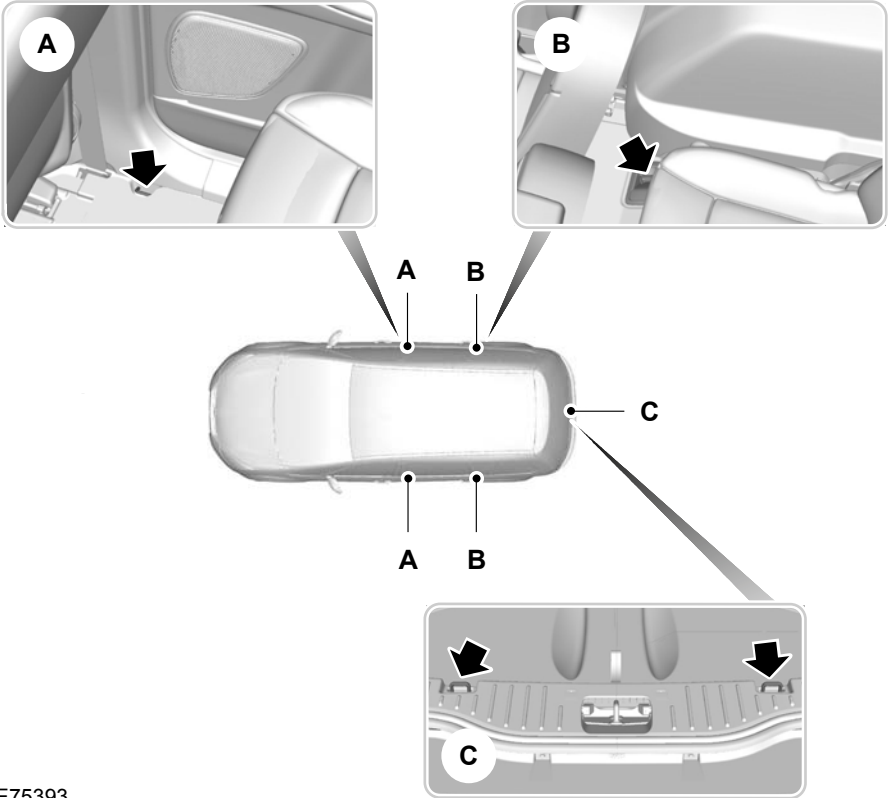

E75393

Load carrying

S-MAX

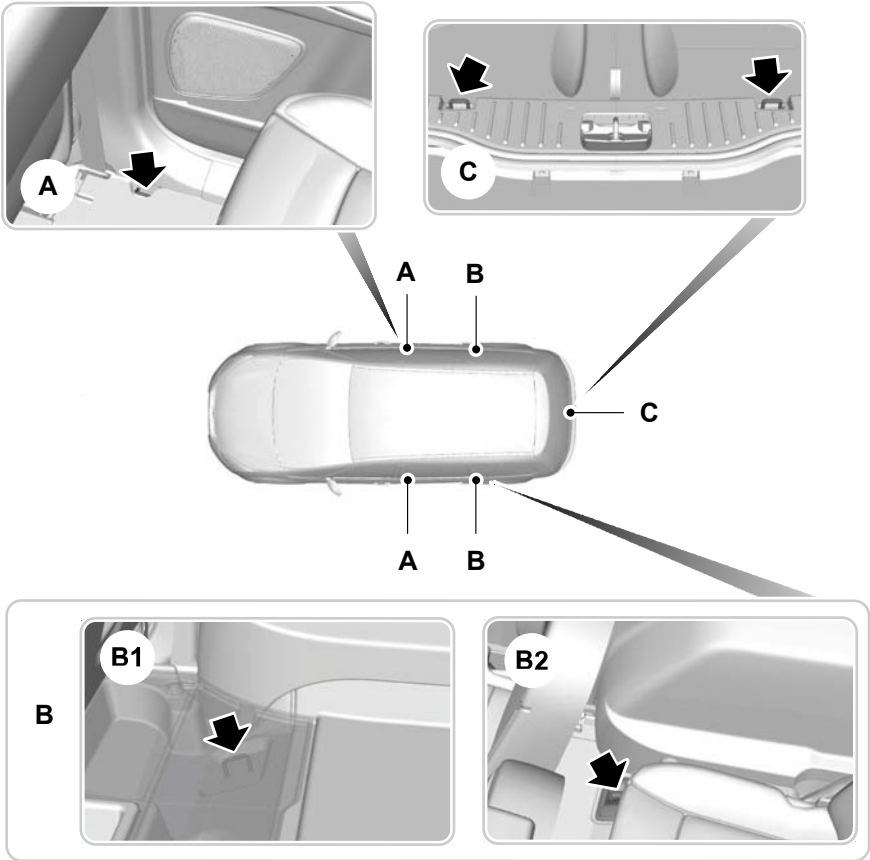

E75394

- B1 Vehicles without third row seats. Raise the carpet to gain access to the anchor points.
- B2 Vehicles with third row seats

Load carrying

SLIDING LOADSPACE FLOOR

WARNING



Do not slide the loadspace floor rearwards when the vehicle is standing on an incline of 15 degrees or more and facing uphill.

CAUTION



The maximum permissible weight on the sliding loadspace floor is 200 kilogrammes (441 pounds).

The maximum permissible weight on the end of the sliding loadspace floor when the floor is in the fully extended position (slid outside the luggage compartment) is 120 kilogrammes (265 pounds).

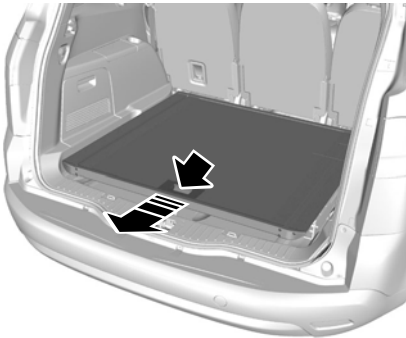

E74810

Press the unlocking handle and pull the loadspace floor rearwards. It will stop and engage at a midway position.

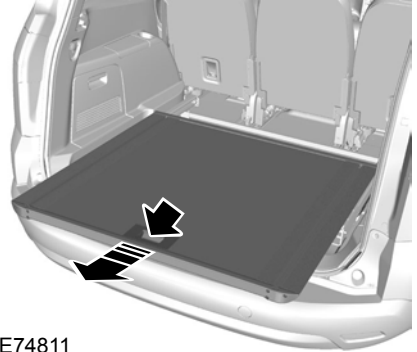

E74811

To slide it out fully, press the unlocking handle again and pull it out until it engages in the end position.

To slide it forwards, press the unlocking handle and push it forwards.

Note: *You do not have to exert as much pressure on the unlocking handle if you push the loadspace floor forwards slightly when operating it.*

Storage compartment

A storage compartment is located in the floor at the rear of the luggage compartment.

To gain access to the storage compartment, lift up the sliding loadspace floor as follows:

Load carrying

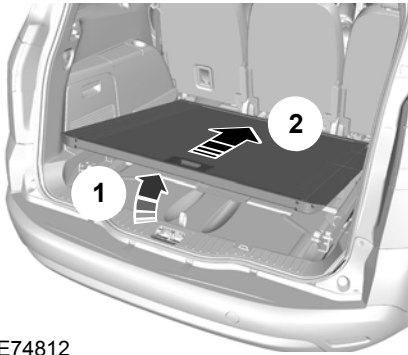

E74812

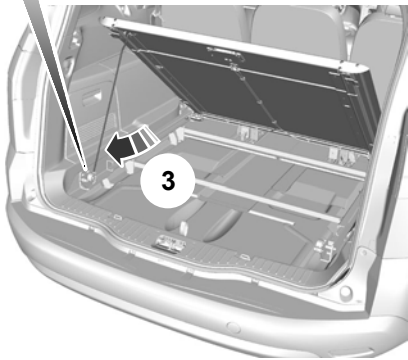
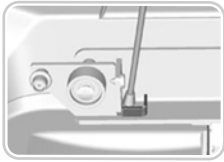

E74813

1. Press the unlocking handle and pull the loadspace floor rearwards a short way.
2. Lift up the rear of the floor (1).

3. Push the floor forwards until it engages at the front (2).
4. Release the support leg from the clip on the underside of the floor.
5. Insert the end into the square retainer in the left-hand rail (3).
6. Lift the storage compartment cover using the loop.

To return the loadspace floor to the normal position:

1. Hold the floor with one hand and release the support leg with the other hand.
2. Insert the support leg back into the clip.
3. Lower the floor.
4. Press the unlocking handle and pull the loadspace floor rearwards until it drops into position on the rails.

REAR UNDER FLOOR STORAGE

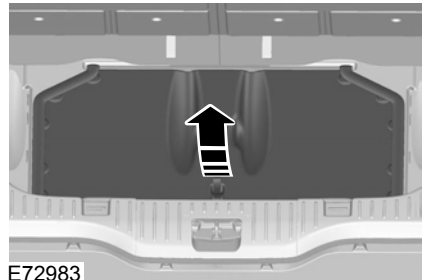

E72983

Vehicles with a sliding loadspace floor

Raise the loadspace floor to gain access to the storage compartment. See **Sliding loadspace floor** (page 171).

Load carrying

S-MAX

Vehicles without third row seats

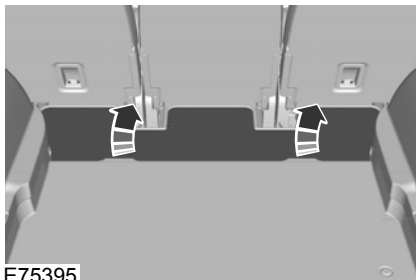

CARGO NETS

Luggage retention net - type 1

WARNING



When the retention net is installed, do not sit in the seats behind it.

CAUTION



Keep a distance of at least one centimetre (1/2 inch) between the retention net and the seats in front of it.

You can install the net in the following positions:

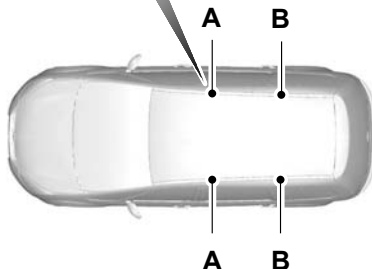
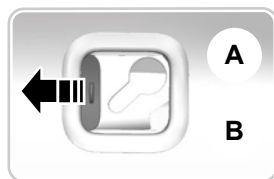

- A Behind the front seats
- B Behind the second row seats

Load carrying

Installing the net

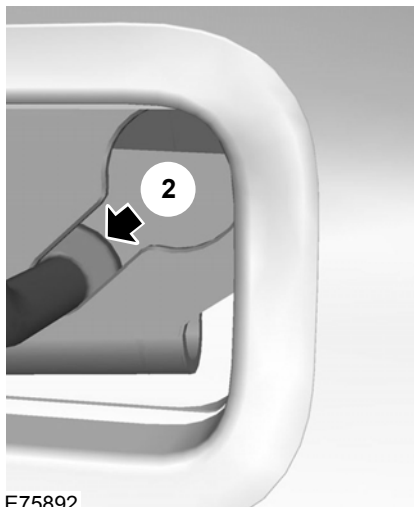
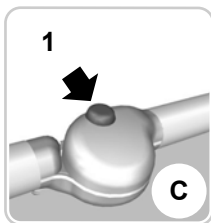

E75892

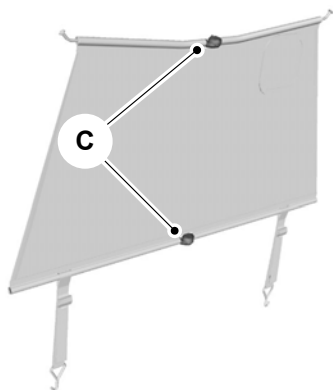

E75893

C Release button

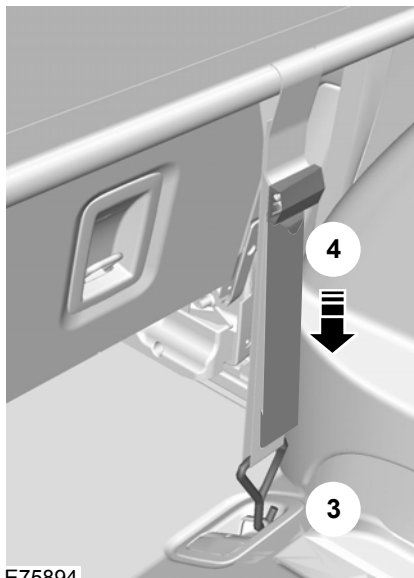

E75894

Load carrying

1. Fold the seatbacks down. See **Rear seats** (page 121).
2. If the retention net is folded, press the red release button **C** on the hinges of the upper and lower bar **1** and unfold it.
3. Push the ends of the upper bar towards each other and insert them into the retainers on the roof **A** or **B**. Make sure that the flap for the centre seat belt is situated on the right hand side of the vehicle.
4. Push the bar forwards into the narrow section of the retainers **2**.
5. Attach the net to the luggage anchor points **3**. See **Luggage anchor points** (page 169).
6. Tighten the belts **4**.

Remove in the reverse order.

If you need to use the centre seat belt:

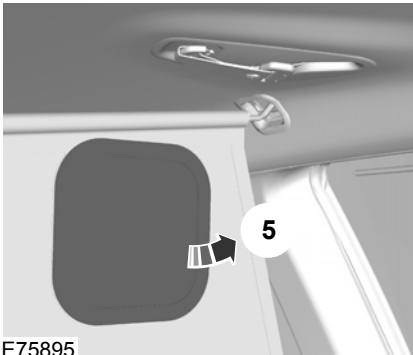

E75895

1. Open the flap **5**.
2. Route the seat belt through the opening.

Luggage retention net - type 2

CAUTIONS

- ⚠ Do not exceed the maximum permissible retention net load of 1 kilogram (2 pounds).
- ⚠ Do not place large objects in the lower net storage compartments.
- ⚠ Make sure that the rods are securely positioned in the trim panels.

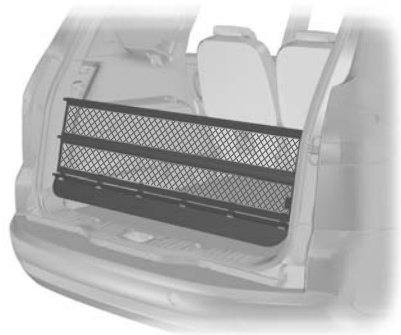

E95920

1. Fold the third row seats flat. See **Rear seats** (page 121).
2. Insert one end of each rod into the retainers in the luggage compartment trim panel.
3. Push the other end of each rod toward its centre and insert the rod into the retainer in the opposite trim panel.

Note: The upper rod ends can be inserted into either the top or front retainer in the trim panels.

Note: On S-MAX the lower net incorporates three storage compartments. Make sure that the net is positioned so that the storage compartments face towards the rear.

Load carrying

LUGGAGE COVERS

WARNING



Do not place objects on the luggage cover.

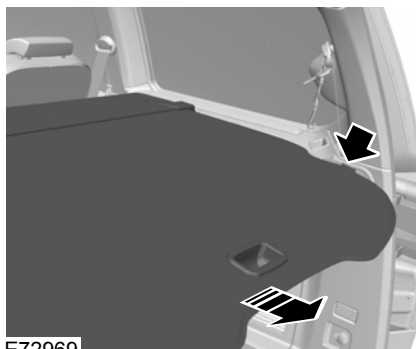

E72969

Pull out the cover and secure it in the retaining points.

Release it from the retaining points and let it roll back into the case. Clip the retaining hook onto the case.

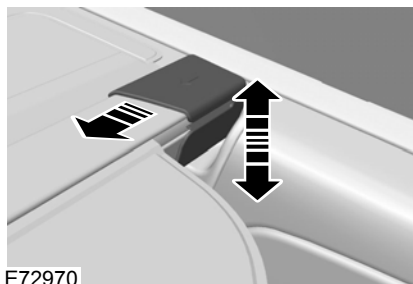

E72970

To remove or install the cover, push either end of the case inwards.

ROOF RACKS AND LOAD CARRIERS

Roof rack

WARNINGS



If you use a roof rack, the fuel consumption of your vehicle will be higher and you may experience different driving characteristics.



Read and follow the manufacturer's instructions when you are fitting a roof rack.

CAUTION



Do not exceed the maximum permissible roof load of 75 kilogrammes (165 pounds) (including the roof rack).

Check the security of the roof rack and tighten its fittings as follows:

- before starting
- after driving 50 kilometres (30 miles)
- at 1 000 kilometres (600 miles) intervals.

To minimise windnoise when the roof rack is not in use, cross rails should be moved rearwards and placed together. To reduce fuel consumption, cross rails should be removed when not in use.

Load carrying

LOAD RETAINING FIXTURES

Installing the load retaining fixtures

Seatback



E75002

WARNINGS



Do not raise the seatback when a load retaining fixture is installed.



Do not exceed the maximum permissible load of 60 kilogrammes (132 pounds) on two load retaining fixtures and 30 kilogrammes (66 pounds) on one.

Check the security of the load retaining fixtures and tighten its fittings as follows:

- before starting
- after driving 50 kilometres (30 miles)
- at 1 000 kilometres (600 miles) intervals.

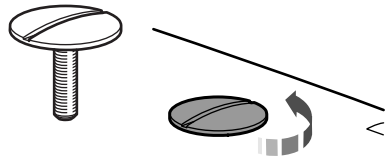

E74997

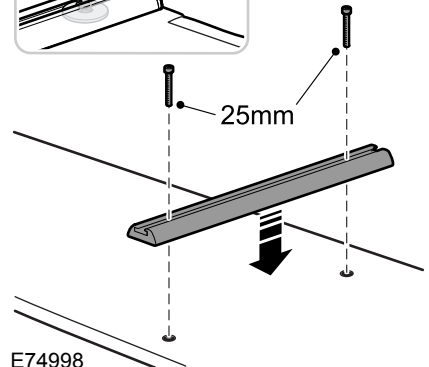
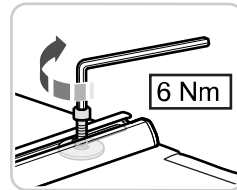

E74998

Load carrying

Luggage compartment floor (vehicles with five seats)

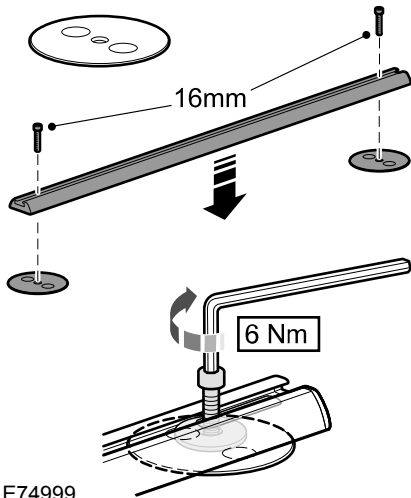

Sliding loadspace floor

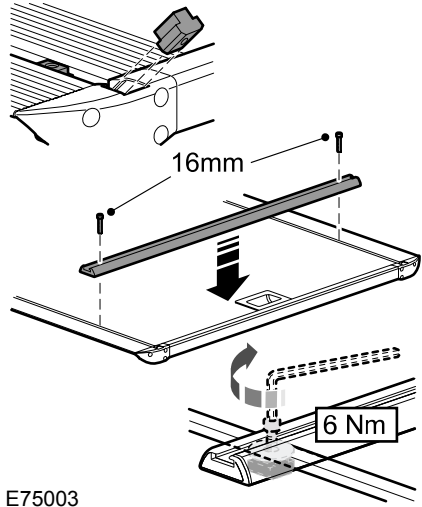

Load carrying

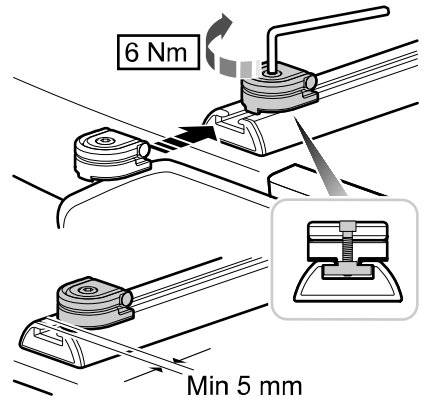
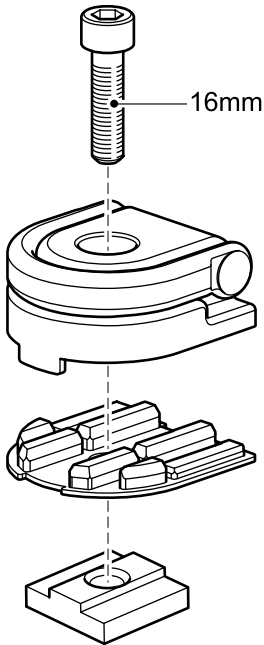

Installing the luggage anchor points



E75001

Installing the load bracket

WARNINGS

-  Install the load bracket with the longest section towards the rear of the vehicle. If you install it the wrong way round, it may not hold the box in place in the event of an accident.
-  Do not install the load bracket on a second row seatback. It cannot be installed the right way round in this position.
-  Do not exceed the maximum permissible load of 20 kilogrammes (44 pounds).

Load carrying

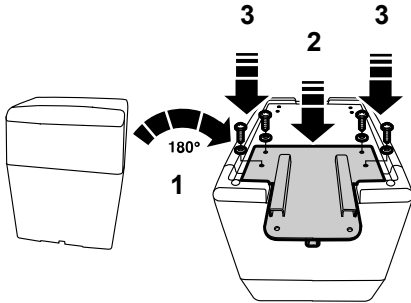

E76378

1. Turn the box over.
2. Position the load bracket.
3. Secure the load bracket with four screws.

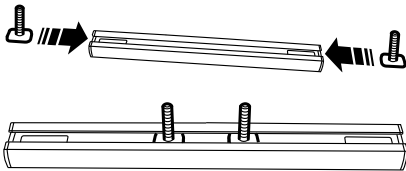

E76379

4. Slide the captured bolts onto the load retaining fixture.

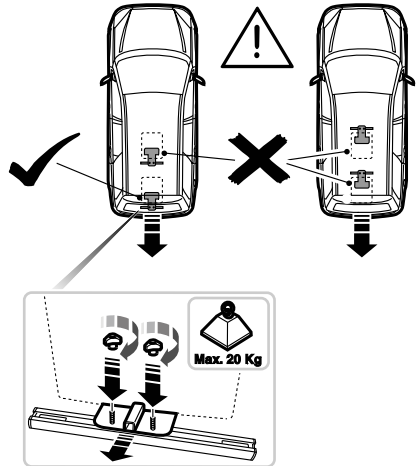

E76380

5. Position the load bracket onto the folded seatback so that the captured bolts go through the two holes in longest section of the bracket.
6. Secure the load bracket with the two wing nuts.
7. Remove in the reverse order.

DOG GUARD

WARNING



When the dog guard is installed, do not sit in the seats behind it.

CAUTION



Keep a distance of at least one centimetre (1/2 inch) between the dog guard and the seats in front of it.

You can install the dog guard in the following positions:

Load carrying

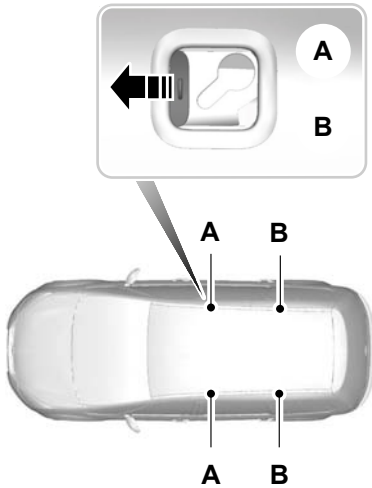

E75891

- A Behind the front seats
- B Behind the second row seats

Installing the dog guard

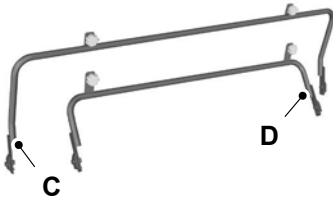

E75896

- C Bar for installing the dog guard behind the front seats
- D Bar for installing the dog guard behind the second row seats

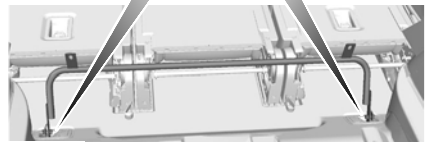
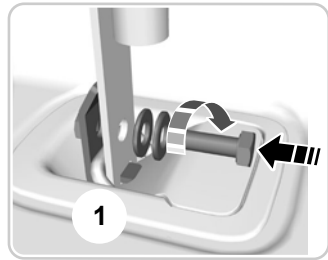

E75897

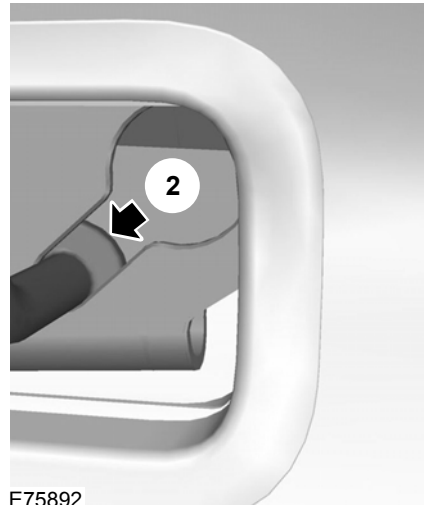

E75892

Load carrying

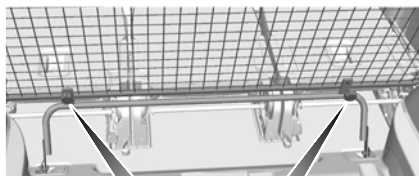

E75898

1. Fold the seatbacks down. See **Rear seats** (page 121).
2. Attach the bar (**C** or **D**) to the luggage anchor points **1**. See **Luggage anchor points** (page 169). Do not tighten the screws.
3. Push the ends of the bar on the grille towards each other and insert them into the retainers on the roof (**A** or **B**). Make sure that the flap for the centre seat belt is situated on the right hand side of the vehicle.
4. Push the bar forwards into the narrow section of the retainers **2**.
5. Attach the grille to the lower bar with the handwheels **3**. Do not tighten the handwheels.
6. Tighten the screws at the luggage anchor points.
7. Tighten the handwheels **3**.

Remove in the reverse order.

If you need to use the centre seat belt:

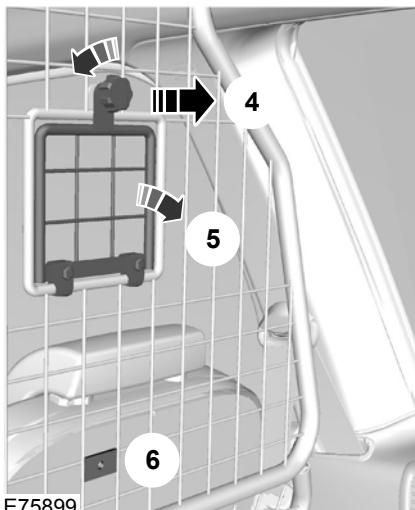

E75899

1. Loosen the handwheel and remove it **4**.
2. Fold down the flap **5**.
3. Fix the flap with the handwheel **6**.
4. Route the seat belt through the opening.

Towing

TOWING A TRAILER

WARNINGS



Do not exceed 100 km/h (62 mph).



The rear tyre pressures must be increased by 0.2 bar (3 psi) above specification. See **Technical specifications** (page 235).



Do not exceed the maximum vehicle and trailer weight stated on the vehicle identification plate. See **Vehicle identification** (page 238).

Note: *Not all vehicles are suitable or approved to have tow bars fitted. Check with your dealer first.*

Place loads as low and central to the axle(s) of the trailer as possible. If you are towing with an unladen vehicle, the load in the trailer should be placed toward the nose, within the maximum nose load, as this gives the best stability.

Note: *The maximum trailer nose weight can be found in the original vehicle documents (confirmation of conformity). Alternatively refer to your dealer.*

The stability of the vehicle to trailer combination is very much dependant on the quality of the trailer.

In high altitude regions above 1 000 metres (3 281 feet), the stipulated maximum permitted gross train weight must be reduced by 10% for every additional 1 000 metres (3 281 feet).

Steep gradients

WARNING



The overrun brake on a trailer is not controlled by ABS.

Change down a gear before you reach a steep downhill gradient.

DETACHABLE TOW BALL

WARNINGS



When not in use, always transport the tow ball arm securely fastened in the luggage compartment.



Take special care when fitting the tow ball arm as the safety of the vehicle and the trailer depends on this.



Do not use any tools for mounting or dismounting the tow ball arm. Do not modify the trailer coupling. Do not disassemble or repair the tow ball arm.

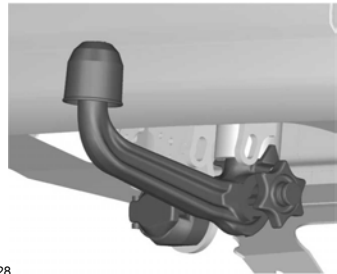

E71328

A 13-pin trailer socket and the tow ball arm seat are provided underneath the rear bumper. Turn the trailer socket down through 90 degrees until it engages in the end position.

Towing

Unlocking the tow ball arm mechanism

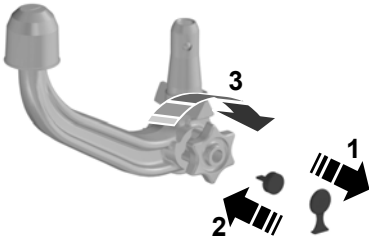

E71329

1. Remove the protecting cap (1). Insert the key and turn it clockwise to unlock (2).
2. Hold the tow ball arm. Pull the handwheel out and turn it clockwise until it clicks (3).
3. The red mark on the handwheel must align with the green mark on the tow ball.
4. Release the handwheel. The tow ball arm is unlocked.

Inserting the tow ball arm

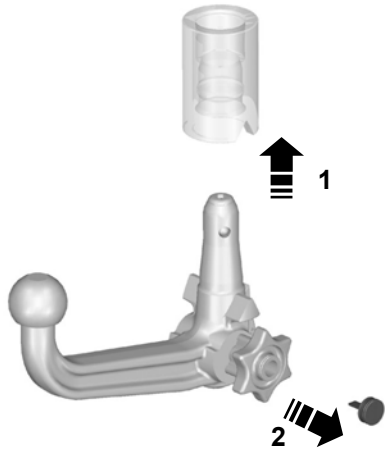

E71330

WARNING



The tow ball arm may only be inserted when completely unlocked.

1. Pull out the plug.
2. Insert the tow ball arm vertically and press it upwards until it engages (1). Do not hold your hand near the handwheel.
3. The green mark on the handwheel must align with the green mark on the tow ball.
4. To lock, turn the key anti-clockwise and remove the key (2).
5. Pull the protecting cap from the key bow and press it onto the lock.

Towing

Driving with a trailer

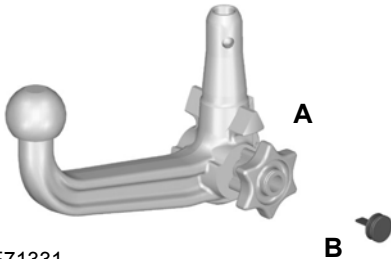

E71331

WARNING



If any of the below conditions cannot be met, do not use the tow bar and have it checked by a properly trained technician.

Before starting your journey, make sure that the tow ball arm is properly locked. Check:

- the green marks are aligned.
- the handwheel (**A**) is correctly fitted to the tow ball arm.
- you have removed the key (**B**).
- the tow ball arm is securely positioned. It must not move when jerked.

Removing the tow ball arm

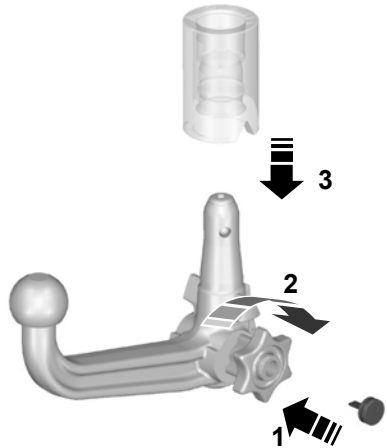

E71332

1. Unhitch the trailer.
2. Remove the protecting cap. Press the cap into the key bow. Insert the key and unlock (**1**).
3. Hold the tow ball arm. Pull the handwheel out, turn it clockwise against the stop (**2**) and remove the tow ball arm (**3**).
4. Release the handwheel.

When unlocked in this way, the tow ball arm can be reinserted at any time.

Towing

Driving without a trailer

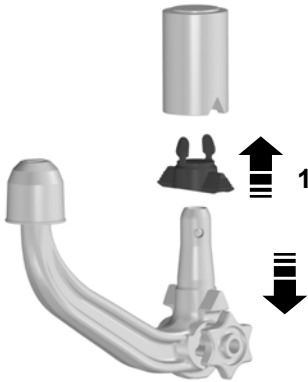

E94771

1. Remove the tow ball arm.
2. Insert the plug into its seat (1).

WARNING



Never unlock the tow ball arm with the trailer attached.

Maintenance

CAUTION



Remove the tow ball arm and protect the seat with the plug before steam cleaning your vehicle.

Keep the system clean. Periodically lubricate bearings, sliding surfaces, and locking balls with resin-free grease or oil and the lock with graphite.

Keep a note of the key number. In case of loss, replacement keys are available from the manufacturer by stating the 4-digit key number.

RETRACTABLE TOW BALL

CAUTION



Only move the tow ball arm with your hand. Never use your foot or auxiliary tools as damage to the mechanism may result.

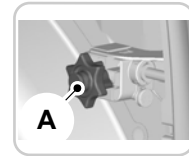

E75173

You can turn the retractable tow ball arm through 90 degrees using the handwheel **A**.

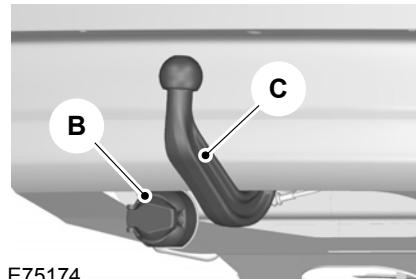

E75174

Towing

A 13-pin trailer socket **B** is provided underneath the rear bumper next to the tow ball arm **C**.

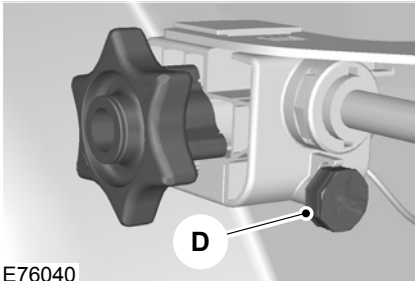

E76040

Note: When not in use, insert the key into the storage position **D** to the right of the handwheel.

Swivelling the tow ball in

WARNINGS



Keep your hands away from the handwheel as it rotates during the locking process.



You will hear a warning tone when the tow ball arm is not in one of the locked positions. If you do not hear the tone when moving the tow ball arm, do not use the tow bar and have it checked by a properly trained technician.

CAUTION



Before retracting the ball neck into its storage position always unhitch the trailer or dismantle load carriers and their attachments. Dismantle attachments for tracking stabilisation. Remove the plug for the trailer power supply and the adapter from the socket. Failure to do so may result in damage to the bumper.

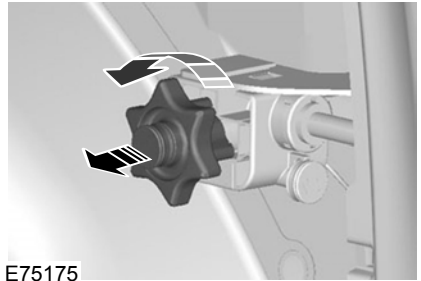

E75175

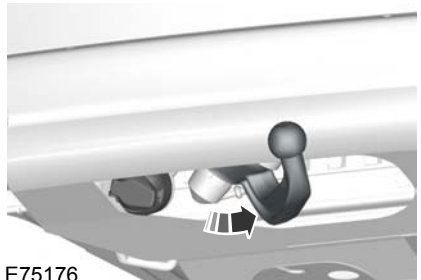

E75176

1. Insert the key into the handwheel and turn it clockwise to unlock.
2. Pull the handwheel out and turn it anti-clockwise to the stop. The tow ball arm automatically swivels into a midway position.
3. Release the handwheel. The tow ball arm is not locked. This is indicated by the warning tone and the handwheel projects about five millimetres (0.2 inch) from its housing.

Towing

4. Manually turn the tow ball arm steadily from its midway position to the stop in the stowage position. The tow ball arm automatically locks in the end position. The locking process is clearly audible if the level of background noise is not too high. When the locking process is completed, the warning tone stops and the handwheel will return to its original position.
5. Turn the key anti-clockwise and remove it. Insert the key into the storage position.

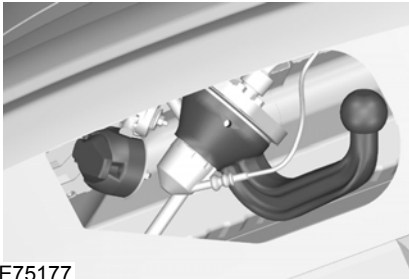

E75177

Swivelling the tow ball out

WARNING

 You will hear a warning tone when the tow ball arm is not in one of the locked positions. If you do not hear the tone when moving the tow ball arm, do not use the tow bar and have it checked by a properly trained technician.

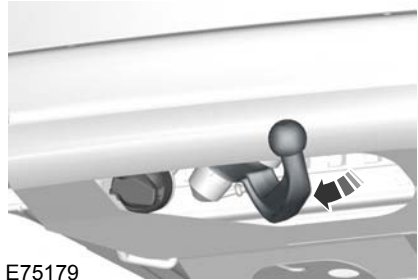

E75179

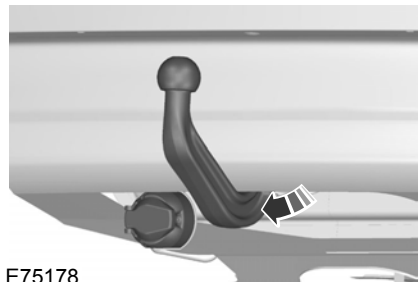

E75178

1. Insert the key into the handwheel and turn it clockwise to unlock.
2. Pull the handwheel out and turn it anti-clockwise to the stop. The tow ball arm automatically swivels into the midway position.
3. Release the handwheel. The tow ball arm is not locked. This is indicated by the warning tone and the handwheel projects about five millimetres (0.2 inch) from its housing.

Towing

4. Manually turn the tow ball arm steadily from its midway position to the stop in the operating position. The tow ball arm automatically locks in the end position. The locking process is clearly audible if the level of background noise is not too high. When the locking process is completed, the warning tone stops and the handwheel will return to its original position.
5. Turn the key anti-clockwise and remove it. Insert the key into the storage position.

CAUTIONS

 When cleaning the vehicle with a steam jet do not direct the high pressure jet directly onto the swivel joint of the tow ball arm.

Driving with a trailer

WARNING



If any of the conditions below cannot be met, do not use the tow bar and have it checked by a properly trained technician.

Before starting your journey, make sure that the tow ball arm is properly locked. Check that:

- there is no warning tone when the locking procedure has been completed
- the handwheel is in its housing and that there is no gap
- you have locked the handwheel (anti-clockwise) and removed the key
- the tow ball arm is locked. It must not move when jerked.

Maintenance

CAUTIONS



The towing hitch and control unit are maintenance-free. Do not grease or oil them.



Only the manufacturer should carry out repairs or dismantle the towing hitch.

Driving hints

RUNNING-IN

Tyres

WARNING



New tyres need to be run-in for approximately 500 kilometres (300 miles). During this time, you may experience different driving characteristics.

Brakes and clutch

WARNING



Avoid heavy use of the brakes and clutch if possible for the first 150 kilometres (100 miles) in town and for the first 1 500 kilometres (1 000 miles) on motorways.

Engine

CAUTION



Avoid driving too fast during the first 1 500 kilometres (1 000 miles). Vary your speed frequently and change up through the gears early. Do not labour the engine.

DRIVING THROUGH WATER

Driving through water

CAUTIONS



Drive through water in an emergency only, and not as part of normal driving.



Engine damage can occur if water enters the air filter.

In an emergency, the vehicle can be driven through water to a maximum depth of 200 mm and at a maximum speed of 10 km/h (6 mph). Extra caution should be exercised when driving through flowing water.

When driving in water, maintain a low speed and do not stop the vehicle. After driving through water, and as soon as it is safe to do so:

- Depress the brake pedal lightly and check that full brake function is achieved.
- Check that the horn works.
- Check that the vehicle's lights are fully operational.
- Check the power assistance of the steering system.

Emergency equipment

FIRST AID KIT

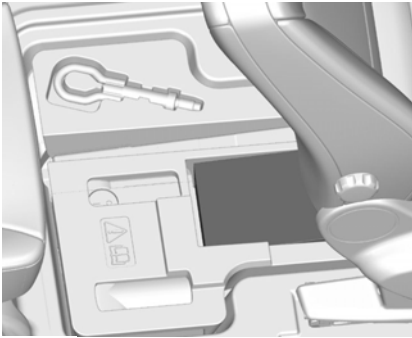

E73238

Space is provided in the under floor storage compartment to store a first aid kit. See **Storage compartments** (page 131).

WARNING TRIANGLE

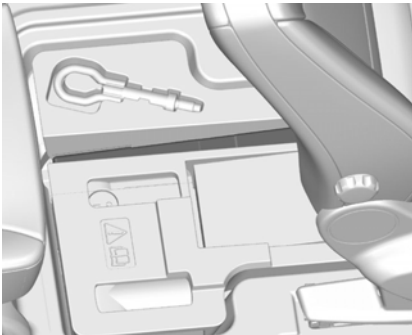

E73239

Space is provided in the under floor storage compartment to store a warning triangle. See **Storage compartments** (page 131).

Status after a collision

INSPECTING SAFETY SYSTEM COMPONENTS

Seat belts

Belts subjected to strain, as a result of an accident, should be renewed and the anchorages checked by a properly trained technician.

Fuses

FUSE BOX LOCATIONS

Engine compartment fuse box

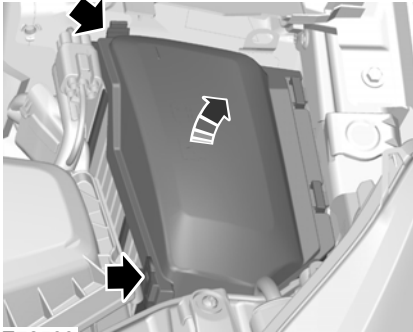

E72588

Central fuse box



E72589

1. Loosen the screws.

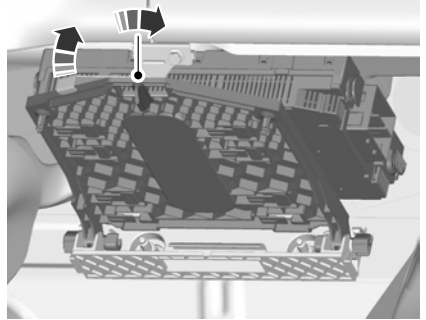

E72590

2. Turn the knob through 90 degrees and release the fuse box from the retaining bracket.
3. Lower the fuse box and pull it towards you.

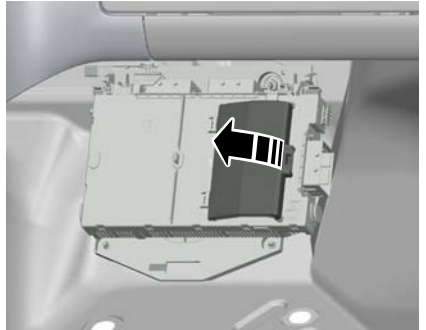

E72622

4. Remove the cover to gain access to the fuses (vehicles with a cooled glove box).
5. Install in the reverse order.

Fuses

Rear fuse box

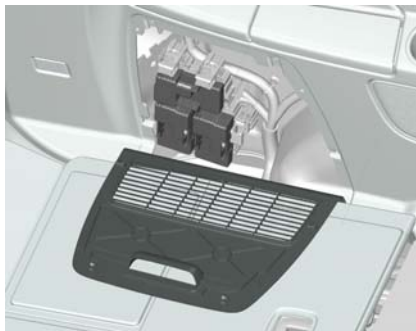



E72591

Release the catches and remove the cover.

CHANGING A FUSE

WARNINGS

 Do not modify the electrical system of your vehicle in any way. Have repairs to the electrical system and the replacement of relays and high current fuses carried out by a properly trained technician.

 Switch the ignition and all electrical equipment off before touching or attempting to change a fuse.

CAUTION

 Fit a replacement fuse with the same rating as the one you have removed.

Note: You can identify a blown fuse by a break in the filament.

Note: All fuses, except high current fuses, are a push fit.

Note: A fuse puller is located in the engine compartment fuse box.

Fuses

FUSE SPECIFICATION CHART

Engine compartment fuse box

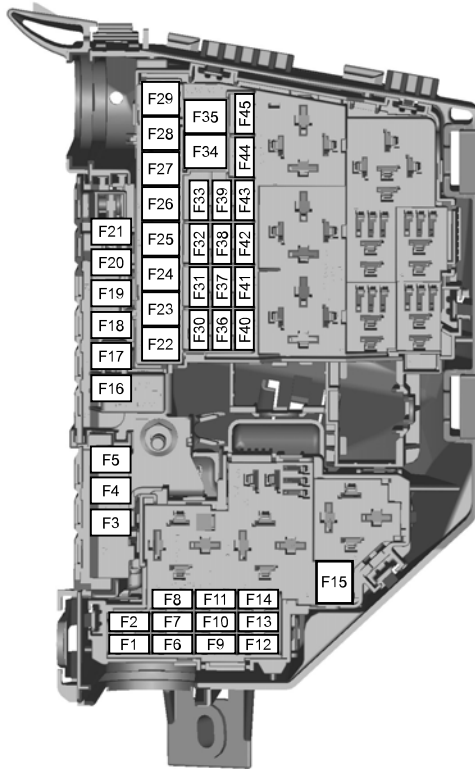

E75525

| Fuse | Ampere rating | Colour | Circuits protected |
|------|---------------|--------|---------------------------------------|
| F1 | 10 | red | Transmission control module |
| F2 | 5 | tan | Glow plug monitoring (diesel engines) |

Fuses

| Fuse | Ampere rating | Colour | Circuits protected |
|-------------|----------------------|---------------|--|
| F3 | 70 ¹ | brown | Engine cooling fan - twin fan (2.3L Duratec-HE) |
| F3 | 80 ¹ | clear | Electric hydraulic power steering (EHPAS) (2.0L Duratorq-TDCi) |
| F4 | 60 | yellow | Glow plugs |
| F5 | 60 | yellow | Engine cooling fan |
| F6 | 10 | red | HEGO sensor (engine management), CMS Sensor, Oxygen Sensor |
| F7 | 5 | tan | Relay coils |
| F8 | 10 | red | Powertrain control module |
| F9 | 10 | red | MAF Sensor, Swirl Control Valve , Fuel Injectors, CCV PTC Heater, Variable Intake valve, Variable Exhaust Valve (engine management) |
| F10 | 10 | red | Engine control module |
| F11 | 10 | red | PCV Valve, VCV Valve, Water in Fuel Sensor, Sonic Purge Valve, Swirl Control Valve, Variable Intake Valve, EGR Valve, IVVT Oil Control Valve (engine management) |
| F11 | 10 | red | Powertrain control module (2.2L Duratec-HE and 2.3L Duratec-HE) |
| F12 | 10 | red | EGR Throttle, Variable Turbo Control Valve, Coil on Plug; Canister Purge Valve, Power Steering Pressure Switch (engine management) |
| F12 | 10 | red | Glow plug relay, air conditioning (AC) clutch relay(2.2L Duratorq-TDCi) |
| F13 | 15 | blue | Air conditioning relay |
| F14 | 15 | blue | Diesel filter heater, fuel metering unit (2.2L Duratorq-TDCi) |
| F15 | 40 | orange | Starter relay |
| F16 | 80 | clear | Diesel auxiliary heater (PTC) |

Fuses

| Fuse | Ampere rating | Colour | Circuits protected |
|------|-----------------|--------|--|
| F17 | 60 | yellow | Central fuse box supply A |
| F18 | 60 | yellow | Central fuse box supply B |
| F19 | 60 | yellow | Rear fuse box supply C |
| F20 | 60 | yellow | Rear fuse box supply D |
| F21 | – | – | Not used |
| F22 | 30 | green | Windscreen wiper module |
| F23 | 25 ¹ | clear | Heated rear window |
| F24 | 30 | green | Headlamp washer |
| F25 | 30 | green | ABS valves |
| F26 | 40 | orange | ABS pump |
| F27 | 30 | green | Fuel fired heater |
| F28 | 40 | orange | Heater blower |
| F29 | – | – | Not used |
| F30 | – | – | Not used |
| F31 | 15 | blue | Horn |
| F32 | 5 | tan | Fuel fired heater - remote control |
| F33 | 5 | tan | Light switch module, engine compartment fuse box coils |
| F34 | 40 | orange | Heated windscreen (left-hand side) |
| F35 | 40 | orange | Heated windscreen (right-hand side) |
| F36 | 5 | tan | ABS |
| F37 | 10 | red | Heated front washer jets |
| F38 | 5 | tan | Adaptive cruise control (ACC) |
| F39 | 15 | blue | Adaptive front lighting system (AFS) |
| F40 | – | – | Not used |
| F41 | 20 | yellow | Instrument panel |

Fuses

| Fuse | Ampere rating | Colour | Circuits protected |
|------|---------------|--------|--|
| F42 | 10 | red | Engine control module, transmission control module, electric hydraulic power steering (EHPAS) (2.0L Duratorq-TDCi) |
| F43 | 5 | tan | Headlamp levelling, adaptive front lighting system (AFS) |
| F44 | - | - | Not used |
| F45 | 15 | blue | Rear window wiper |

¹Fit a replacement with the same rating as the one you have removed.

Central fuse box

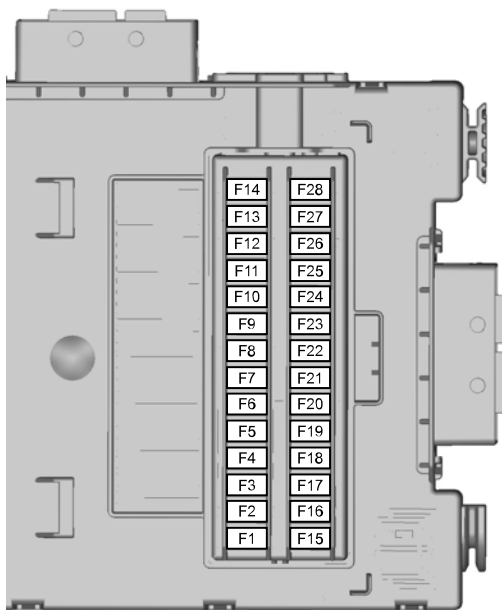

E75527

Fuses

| Fuse | Ampere rating | Colour | Circuits protected |
|-------------|----------------------|---------------|--|
| F1 | 5 | tan | Rain sensor |
| F2 | 10 | red | SRS (airbag) supply |
| F3 | 7.5 | brown | ABS, yaw rate sensor (ESP), electric parking brake (EPB), accelerator pedal supply |
| F4 | 7.5 | brown | Electronic feed, electronic fuse |
| F5 | - | - | Not used |
| F6 | 15 | blue | Audio system (including voice control) |
| F7 | 7.5 | brown | Steering wheel module |
| F8 | 5 | tan | Instrument cluster |
| F9 | 15 | blue | Main beam |
| F10 | - | - | Not used |
| F11 | 7.5 | brown | Reversing lamps |
| F12 | - | - | Not used |
| F13 | 15 | blue | Front fog lamp |
| F14 | 15 | blue | Windscreen washers |
| F15 | 10 | red | Adaptive cruise control (ACC) |
| F16 | - | - | Not used |
| F17 | 10 | red | Interior lamps |
| F18 | 5 | tan | Engine immobiliser |
| F19 | 15 | blue | Cigar lighter |
| F20 | - | - | Not used |
| F21 | 5 | tan | Remote frequency receiver, Interior motion sensor |
| F22 | 20 | yellow | Fuel pump |
| F22 | 7.5 | brown | Fuel pump (2.2L Duratorq) |
| F23 | - | - | Not used |
| F24 | 5 | tan | Ignition switch |

Fuses

| Fuse | Ampere rating | Colour | Circuits protected |
|-------------|----------------------|---------------|---|
| F25 | 10 | red | Fuel filler flap |
| F26 | 5 | tan | Battery backup sounder (alarm system), OBD II (board computer diagnostics) |
| F27 | 5 | tan | Steering column unit, climate control module |
| F28 | 5 | tan | Brake lamp switch |

Fuses

Rear fuse box

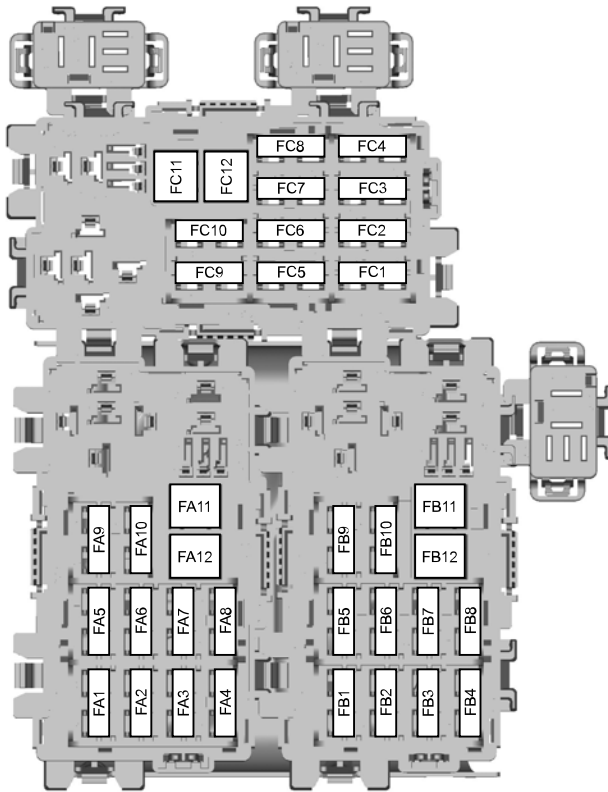

E75526

| Fuse | Ampere rating | Colour | Circuits protected |
|------|---------------|--------|---|
| FA1 | 25 | clear | Door module (left-hand front) (window up/down, central locking, electric folding mirror, heated mirror) |

Fuses

| Fuse | Ampere rating | Colour | Circuits protected |
|-------------|----------------------|---------------|--|
| FA2 | 25 | clear | Door module (right-hand front) (window up/down, central locking, electric folding mirror, heated mirror) |
| FA3 | 25 | clear | Door module (left-hand rear) (window up/down) |
| FA4 | 25 | clear | Door module (right-hand rear) (window up/down) |
| FA5 | 10 | red | Rear locking (without rear door modules) |
| FA6 | 15 | blue | Auxiliary power socket |
| FA7 | 5 | tan | Relay coils |
| FA8 | - | - | Not used |
| FA9 | - | - | Not used |
| FA10 | 30 | green | Electric driver's seat |
| FA11 | 20 | yellow | Accessories, trailer module |
| FA12 | - | - | Not used |
| FB1 | 5 | tan | Parking aid module |
| FB2 | 15 | blue | Suspension module |
| FB3 | 15 | blue | Heated driver's seat |
| FB4 | 15 | blue | Heated front passenger seat |
| FB5 | - | - | Not used |
| FB6 | 10 | red | Rear climate control |
| FB7 | - | - | Not used |
| FB8 | - | - | Not used |
| FB9 | 30 | green | Electric front passenger seat |
| FB10 | 10 | red | Anti-theft alarm horn |
| FB11 | - | - | Not used |
| FB12 | - | - | Not used |
| FC1 | 7.5 | brown | Electric rear quarter windows |

Fuses

| Fuse | Ampere rating | Colour | Circuits protected |
|-------------|----------------------|---------------|--|
| FC2 | 30 | green | Electric parking brake (EPB) |
| FC3 | 30 | green | Electric parking brake (EPB) |
| FC4 | 10 | red | Rear air conditioning |
| FC5 | 7.5 | brown | CD changer, rear seat entertainment system |
| FC6 | 20 | yellow | Rear air conditioning blower |
| FC7 | 5 | tan | Seat memory function module |
| FC8 | – | – | Not used |
| FC9 | – | – | Not used |
| FC10 | – | – | Not used |
| FC11 | – | – | Not used |
| FC12 | – | – | Not used |

Vehicle recovery

TOWING POINTS

Front towing eye

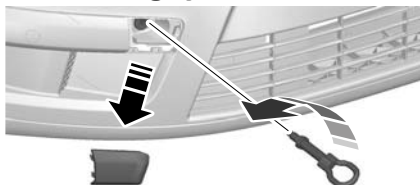

E73241

Rear towing eye



E73242

A Mount for rear towing eye



E73240

The screw-in towing eye is located in the underfloor storage compartment behind the front seats. See **Rear under floor storage** (page 172).

The towing eye must **always** be carried in the vehicle.

Insert your finger into the hole on the underside of the cover and prise off the cover. Install the towing eye.

CAUTION

! The screw-in towing eye has a **left-hand thread**. Turn it **anti-clockwise** to install it.

TOWING THE VEHICLE ON FOUR WHEELS

All vehicles

WARNINGS

! Switch the ignition on when your vehicle is being towed. The steering lock will engage and the direction indicators and brake lamps will not work if you do not.

! The brake servo and the power steering pump do not operate unless the engine is running. Press the brake pedal harder and allow for increased stopping distances and heavier steering.

CAUTIONS

! Too much tension in the tow rope could cause damage to your vehicle or the vehicle that is towing.





! Do not use a rigid tow bar on the front towing eye.

Drive off slowly and smoothly without jerking the vehicle that is towing.

Vehicle recovery

Vehicles with automatic transmission

CAUTIONS

-  Do not tow your vehicle faster than 50 km/h (30 mph) or further than 50 kilometres (30 miles).
 -  If a speed of 50 km/h (30 mph) and a distance of 50 kilometres (30 miles) is to be exceeded the drive wheels must be lifted clear of the ground.
 -  In the event of a mechanical failure of the transmission the drive wheels must be lifted clear of the ground.
 -  Do not tow your vehicle backwards.
 -  Select neutral when your vehicle is being towed.
-

Maintenance

GENERAL INFORMATION

Have your vehicle serviced regularly to help maintain its roadworthiness and resale value. There is a large network of Ford Authorised Repairers that are there to help you with their professional servicing expertise. We believe that their specially trained technicians are best qualified to service your vehicle properly and expertly. They are supported by a wide range of highly specialised tools developed specifically for servicing your vehicle.

In addition to regular servicing, we recommend that you carry out the following additional checks.

WARNINGS



Switch the ignition off before touching or attempting adjustment of any kind.



Do not touch the electronic ignition system parts after you have switched the ignition on or when the engine is running. The system operates at high voltage.



Keep your hands and clothing clear of the engine cooling fan. Under certain conditions, the fan may continue to run for several minutes after you have switched the engine off.

Daily checks

- Exterior lamps.
- Interior lamps.
- Warning lamps and indicators.

Check when refuelling

- Engine oil level. See **Engine oil check** (page 215).
- Brake fluid level. See **Brake and clutch fluid check** (page 216).

- Washer fluid level. See **Washer fluid check** (page 216).
- Tyre pressures (when cold). See **Wheels and tyres** (page 224).
- Tyre condition. See **Wheels and tyres** (page 224).

Monthly checks

- Engine coolant level (engine cold). See **Engine coolant check** (page 215).
- Pipes, hoses and reservoirs for leaks.
- Power steering fluid level. See **Power steering fluid check** (page 216).
- Air conditioning operation.
- Parking brake operation.
- Horn operation.
- Tightness of wheel nuts. See **Wheels and tyres** (page 224).

OPENING AND CLOSING THE BONNET

Opening the bonnet



Maintenance

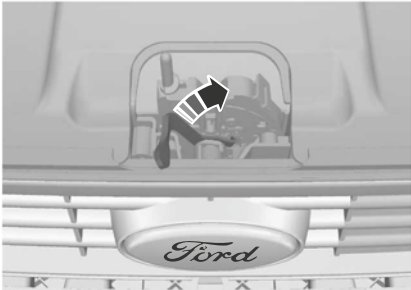

E87785

Raise the bonnet slightly and move the catch towards the left-hand side of the vehicle.

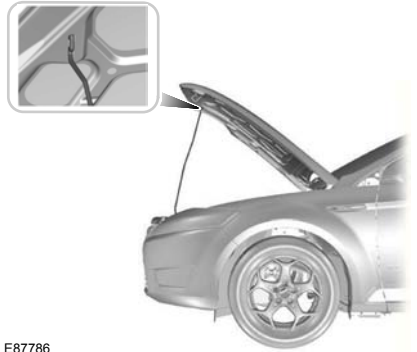

E87786

Open the bonnet and support it with the strut.

Closing the bonnet

WARNING



Make sure that the bonnet is closed properly.

Lower the bonnet and allow it to drop from under its own weight for the last 20 – 30 centimetres (8 - 11 inches).

Maintenance

ENGINE COMPARTMENT OVERVIEW - 2.0L DURATEC-HE (MI4)

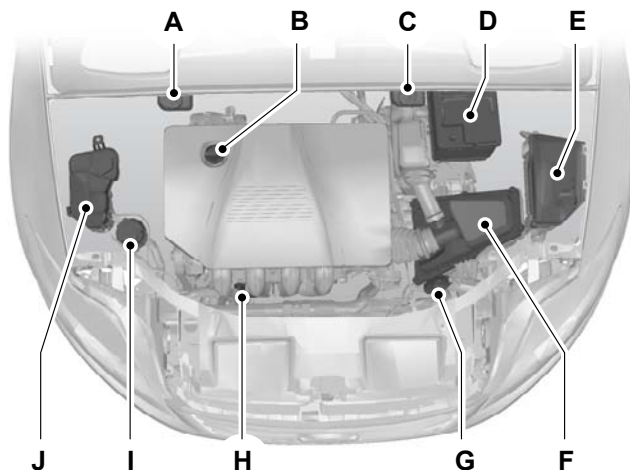

E73231

- A Brake and clutch fluid reservoir (right-hand drive). See **Brake and clutch fluid check** (page 216).
- B Engine oil filler cap¹. See **Engine oil check** (page 215).
- C Brake and clutch fluid reservoir (left-hand drive). See **Brake and clutch fluid check** (page 216).
- D Battery. See **Using booster cables** (page 222).
- E Engine compartment fuse box. See **Fuse specification chart** (page 195).
- F Air cleaner. No maintenance necessary.
- G Screen washer fluid reservoir. See **Washer fluid check** (page 216).
- H Engine oil dipstick¹. See **Engine oil check** (page 215).
- I Power steering fluid reservoir. See **Power steering fluid check** (page 216).
- J Engine coolant reservoir. See **Engine coolant check** (page 215).

¹The filler caps and the engine oil dipstick are coloured for easy identification.

Maintenance

ENGINE COMPARTMENT OVERVIEW - 2.3L DURATEC-HE (MI4)

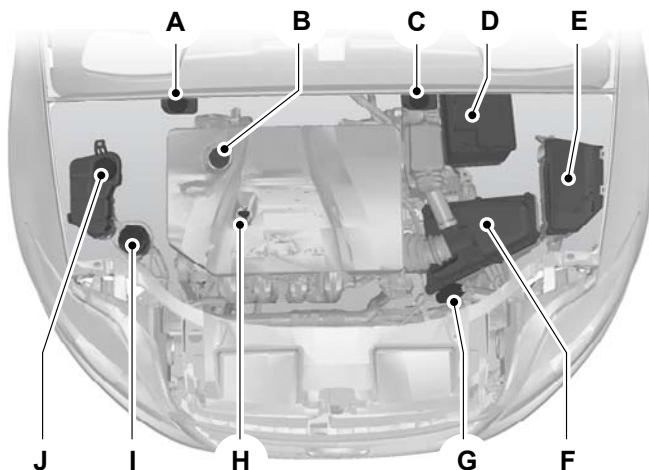

E81313

- A Brake and clutch fluid reservoir (right-hand drive). See **Brake and clutch fluid check** (page 216).
- B Engine oil filler cap¹. See **Engine oil check** (page 215).
- C Brake and clutch fluid reservoir (left-hand drive). See **Brake and clutch fluid check** (page 216).
- D Battery.
- E Engine compartment fuse box. See **Fuse specification chart** (page 195).
- F Air cleaner. No maintenance necessary.
- G Screen washer fluid reservoir. See **Washer fluid check** (page 216).
- H Engine oil dipstick¹. See **Engine oil check** (page 215).
- I Power steering fluid reservoir. See **Power steering fluid check** (page 216).
- J Engine coolant reservoir. See **Engine coolant check** (page 215).

¹The filler caps and the engine oil dipstick are coloured for easy identification.

Maintenance

ENGINE COMPARTMENT OVERVIEW - 2.5L DURATEC (VI5)

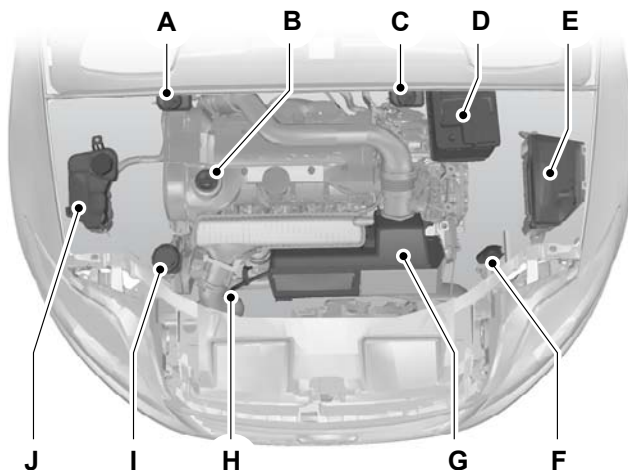

E73232

- A Brake and clutch fluid reservoir (right-hand drive). See **Brake and clutch fluid check** (page 216).
- B Engine oil filler cap¹. See **Engine oil check** (page 215).
- C Brake and clutch fluid reservoir (left-hand drive). See **Brake and clutch fluid check** (page 216).
- D Battery.
- E Engine compartment fuse box. See **Fuse specification chart** (page 195).
- F Screen washer fluid reservoir. See **Washer fluid check** (page 216).
- G Air cleaner. No maintenance necessary.
- H Engine oil dipstick¹. See **Engine oil check** (page 215).
- I Power steering fluid reservoir. See **Power steering fluid check** (page 216).
- J Engine coolant reservoir. See **Engine coolant check** (page 215).

¹The filler caps and the engine oil dipstick are coloured for easy identification.

Maintenance

ENGINE COMPARTMENT OVERVIEW - 1.8L DURATORQ-TDCI (LYNX) DIESEL

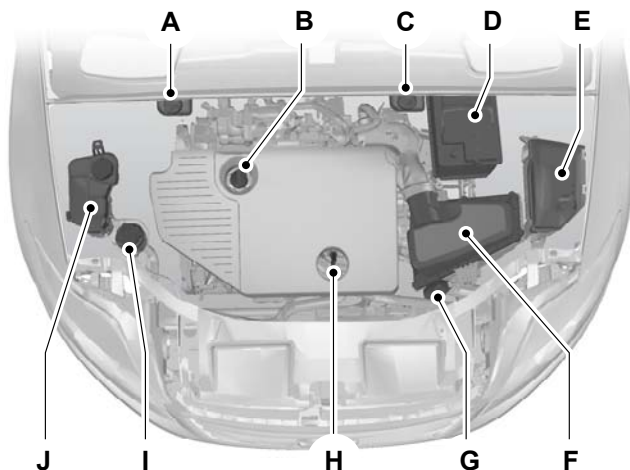

E73233

- A Brake and clutch fluid reservoir (right-hand drive). See **Brake and clutch fluid check** (page 216).
- B Engine oil filler cap¹. See **Engine oil check** (page 215).
- C Brake and clutch fluid reservoir (left-hand drive). See **Brake and clutch fluid check** (page 216).
- D Battery.
- E Engine compartment fuse box. See **Fuse specification chart** (page 195).
- F Air cleaner. No maintenance necessary.
- G Screen washer fluid reservoir. See **Washer fluid check** (page 216).
- H Engine oil dipstick¹. See **Engine oil check** (page 215).
- I Power steering fluid reservoir. See **Power steering fluid check** (page 216).
- J Engine coolant reservoir. See **Engine coolant check** (page 215).

¹The filler caps and the engine oil dipstick are coloured for easy identification.

Maintenance

ENGINE COMPARTMENT OVERVIEW - 2.0L DURATORQ-TDCI (DW) DIESEL

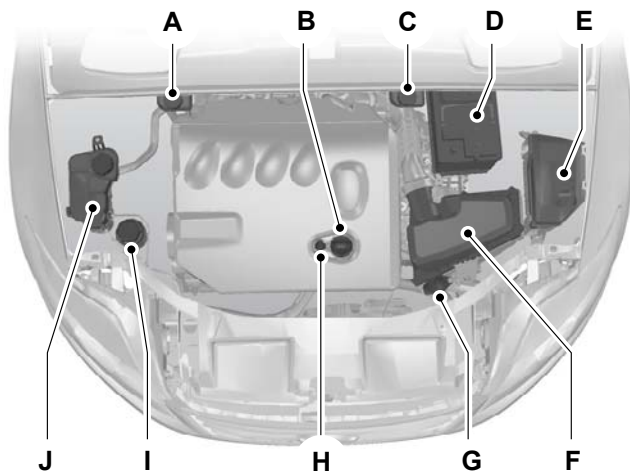

E73234

- A Brake and clutch fluid reservoir (right-hand drive). See **Brake and clutch fluid check** (page 216).
- B Engine oil filler cap¹. See **Engine oil check** (page 215).
- C Brake and clutch fluid reservoir (left-hand drive). See **Brake and clutch fluid check** (page 216).
- D Battery.
- E Engine compartment fuse box. See **Fuse specification chart** (page 195).
- F Air cleaner. No maintenance necessary.
- G Screen washer fluid reservoir. See **Washer fluid check** (page 216).
- H Engine oil dipstick¹. See **Engine oil check** (page 215).
- I Power steering fluid reservoir. See **Power steering fluid check** (page 216).
- J Engine coolant reservoir. See **Engine coolant check** (page 215).

¹The filler caps and the engine oil dipstick are coloured for easy identification.

Maintenance

ENGINE COMPARTMENT OVERVIEW - 2.2L DURATORQ-TDCI (DW) DIESEL

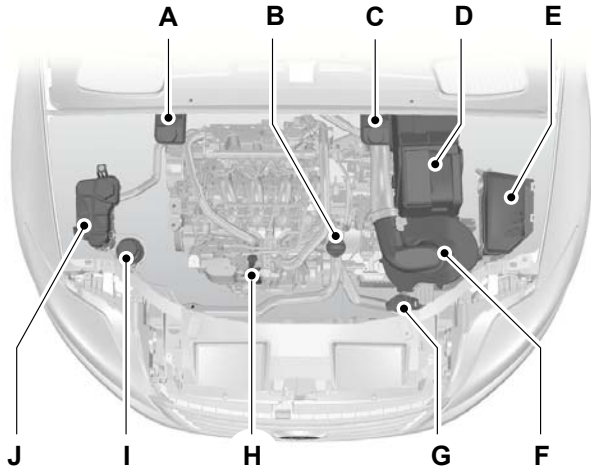

E87715

- A Brake and clutch fluid reservoir (right-hand drive): See **Brake and clutch fluid check** (page 216).
- B Engine oil filler cap¹: See **Engine oil check** (page 215).
- C Brake and clutch fluid reservoir (left-hand drive): See **Brake and clutch fluid check** (page 216).
- D Battery:
- E Engine compartment fuse box: See **Fuses** (page 193).
- F Air cleaner: No maintenance necessary.
- G Screen washer fluid reservoir: See **Washer fluid check** (page 216).
- H Engine oil dipstick¹: See **Engine oil check** (page 215).
- I Power steering fluid reservoir: See **Power steering fluid check** (page 216).
- J Engine coolant reservoir: See **Engine coolant check** (page 215).

¹The filler caps and the engine oil dipstick are coloured for easy identification.

Maintenance

ENGINE OIL DIPSTICK - 2.0L DURATEC-HE (MI4)/2.3L DURATEC-HE (MI4)

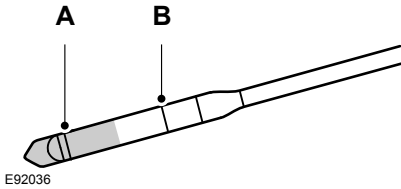

A MIN
B MAX

ENGINE OIL DIPSTICK - 1.8L DURATORQ-TDCI (LYNX) DIESEL

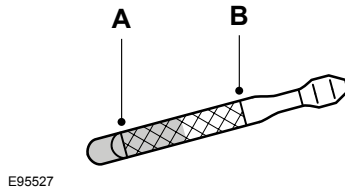

A MIN
B MAX

ENGINE OIL DIPSTICK - 2.5L DURATEC (VI5)

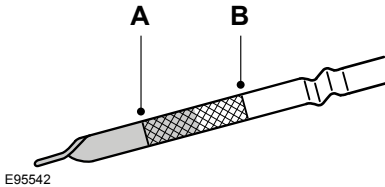

A MIN
B MAX

ENGINE OIL DIPSTICK - 2.0L DURATORQ-TDCI (DW) DIESEL/2.2L DURATORQ- TDCI (DW) DIESEL

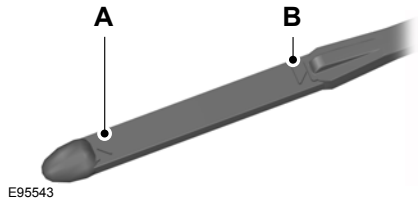

A MIN
B MAX

Maintenance

ENGINE OIL CHECK

CAUTION

 Do not use oil additives or other engine treatments. Under certain conditions, they could damage the engine.

Note: *The oil consumption of new engines reaches its normal level after approximately 5 000 kilometres (3 000 miles).*

Checking the oil level

CAUTION

 Make sure that the level is between the **MIN** and the **MAX** marks.

Note: *Check the level before starting the engine.*

Note: *Make sure that your vehicle is on level ground.*

Note: *Oil expands when it is hot. The level may therefore extend a few millimetres beyond the **MAX** mark.*

Remove the dipstick and wipe it with a clean, lint free cloth. Replace the dipstick and remove it again to check the oil level.

If the level is at the **MIN** mark, top up immediately.

Topping up

WARNINGS

 Only top up when the engine is cold. If the engine is hot, wait 10 minutes for the engine to cool down.

 Do not remove the filler cap when the engine is running.

Remove the filler cap.

CAUTION

 Do not top up further than the **MAX** mark.

Top up with fluid that meets the Ford specification. See **Technical specifications** (page 217).

ENGINE COOLANT CHECK

Checking the coolant level

WARNING

 Do not allow the fluid to touch your skin or eyes. If this happens, rinse the affected areas immediately with plenty of water and contact your doctor.

CAUTION

 Make sure that the level is between the **MIN** and the **MAX** marks.

Note: *Coolant expands when it is hot. The level may therefore extend beyond the **MAX** mark.*

If the level is at the **MIN** mark, top up immediately.

Topping up

WARNINGS

 Only top up when the engine is cold. If the engine is hot, wait 10 minutes for the engine to cool down.



 Do not remove the filler cap when the engine is running.

 Do not remove the filler cap when the engine is hot. Wait for the engine to cool down.

Unscrew the cap **slowly**. Any pressure will escape slowly as you unscrew the cap.

Maintenance



CAUTIONS

-  Do not spill coolant on any part of the engine.
-  Do not top up further than the **MAX** mark.

Top up with fluid that meets the Ford specification. See **Technical specifications** (page 217).

BRAKE AND CLUTCH FLUID CHECK

WARNINGS

-  Do not allow the fluid to touch your skin or eyes. If this happens, rinse the affected areas immediately with plenty of water and contact your doctor.
-  If the level is at the **MIN** mark, have the system checked by a properly trained technician as soon as possible.

Note: *The brake and the clutch systems are supplied from the same reservoir.*

Top up with fluid that meets the Ford specification. See **Technical specifications** (page 217).

POWER STEERING FLUID CHECK

WARNING

-  Do not allow the fluid to touch your skin or eyes. If this happens, rinse the affected areas immediately with plenty of water and contact your doctor.

CAUTION

-  Make sure that the level is between the **MIN** and the **MAX** marks.

If the level is at the **MIN** mark, top up immediately.

Topping up

Remove the filler cap.

CAUTION

-  Do not top up further than the **MAX** mark.

Top up with fluid that meets the Ford specification. See **Technical specifications** (page 217).

WASHER FLUID CHECK

The front and rear washer systems are supplied from the same reservoir.

Maintenance

TECHNICAL SPECIFICATIONS

Vehicle fluids

| Item | Recommended fluid | Specification |
|----------------------|--|---------------|
| Engine oil | Ford or Motorcraft Formula E SAE 5W-30 Engine Oil* | WSS-M2C913-B |
| Power steering fluid | Ford or Motorcraft Power Steering Fluid | WSS-M2C204-A2 |
| Coolant | Motorcraft SuperPlus Anti-freeze | WSS-M97B44-D |
| Brake fluid | Ford or Motorcraft Super DOT 4 Brake Fluid | ESD-M6C57-A |

CAUTION



Do not use oils which do not meet the specifications or requirements. Use of unsuitable oil may lead to engine damage which is not covered by your Warranty.

* You can use an alternative **SAE 5W-30** engine oil, providing it meets the specification defined by **WSS-M2C913-B**.

Note: If you operate your vehicle in temperatures below -20°C (-4°F), you must not use **SAE 10W-40** engine oil.

Topping up the oil: If you are unable to find an oil that meets the specification defined by **WSS-M2C913-B**, you must use **SAE 5W-30** (preferred), **SAE 5W-40** (except vehicles with E85 fuel) or **SAE 10W-40** that meets the specification defined by either **ACEA A1/B1** (preferred) or **ACEA A3/B3**. Using these oils can result in longer engine cranking periods, reduced engine performance, reduced fuel economy and increased emission levels.

Capacities

| Variant | Item | Capacity in litres (gallons) |
|-----------------|--|------------------------------|
| All | Power steering fluid | MAX mark |
| All | Windscreen washer system | 3.9 (0.9) |
| 2.0L Duratec-HE | Engine lubrication system - including the oil filter | 4.3 (1.0) |
| 2.0L Duratec-HE | Engine lubrication system - excluding the oil filter | 3.9 (0.9) |

Maintenance

| Variant | Item | Capacity in litres (gallons) |
|--------------------|--|------------------------------|
| 2.0L Duratec-HE | Engine cooling system | 6.2 (1.4) |
| 2.0L Duratec-HE | Fuel tank | 70 (15.4) |
| 2.3L Duratec-HE | Engine lubrication system - including the oil filter | 4.3 (1.0) |
| 2.3L Duratec-HE | Engine lubrication system - excluding the oil filter | 3.9 (0.9) |
| 2.3L Duratec-HE | Engine cooling system | 6.9 (1.5) |
| 2.3L Duratec-HE | Fuel tank | 70 (15.4) |
| 2.5L Duratec-ST | Engine lubrication system - including the oil filter | 5.8 (1.3) |
| 2.5L Duratec-ST | Engine lubrication system - excluding the oil filter | 5.5 (1.2) |
| 2.5L Duratec-ST | Engine cooling system | 7.1 (1.6) |
| 2.5L Duratec-ST | Fuel tank | 70 (15.4) |
| 1.8L Duratorq-TDCi | Engine lubrication system - including the oil filter | 5.6 (1.2) |
| 1.8L Duratorq-TDCi | Engine lubrication system - excluding the oil filter | 5.0 (1.1) |
| 1.8L Duratorq-TDCi | Engine cooling system | 7.9 (1.7) |
| 1.8L Duratorq-TDCi | Fuel tank | 70 (15.4) |
| 2.0L Duratorq-TDCi | Engine lubrication system - including the oil filter | 5.5 (1.2) |
| 2.0L Duratorq-TDCi | Engine lubrication system - excluding the oil filter | 5.0 (1.1) |
| 2.0L Duratorq-TDCi | Engine cooling system | 8.1 (1.8) |
| 2.0L Duratorq-TDCi | Fuel tank | 70 (15.4) |
| 2.2L Duratorq-TDCi | Engine lubrication system - including the oil filter | 6.0 (1.3) |
| 2.2L Duratorq-TDCi | Engine lubrication system - excluding the oil filter | 5.4 (1.2) |
| 2.2L Duratorq-TDCi | Engine cooling system | 8.4 (1.9) |

Maintenance

| Variant | Item | Capacity in litres (gallons) |
|--------------------|-------------|-------------------------------------|
| 2.2L Duratorq-TDCi | Fuel tank | 70 (15.4) |

Vehicle care

CLEANING THE EXTERIOR

WARNING



If you use a car wash with a waxing cycle, make sure that you remove the wax from the windscreen.

CAUTIONS



Some car wash installations use water at high pressure. This could damage certain parts of your vehicle.



Remove the aerial before using an automatic car wash.



Switch the heater blower off to prevent contamination of the fresh air filter.

We recommend that you wash your vehicle with a sponge and lukewarm water containing a car shampoo.

Cleaning the headlamps

CAUTIONS



Do not scrape the headlamp lenses or use abrasives, alcoholic solvents or chemical solvents to clean them.



Do not wipe the headlamps when they are dry.

Cleaning the rear window

CAUTION



Do not scrape the inside of the rear window or use abrasives or chemical solvents to clean it.

Use a clean, lint free cloth or a damp chamois leather to clean the inside of the rear window.

Cleaning the chrome trim

CAUTION



Do not use abrasives or chemical solvents. Use soapy water.

Body paintwork preservation

CAUTIONS



Do not polish your vehicle in strong sunshine.



Do not allow polish to touch plastic surfaces. It could be difficult to remove.



Do not apply polish to the windscreen or rear window. This could cause the wipers to become noisy and they may not clear the window properly.

We recommend that you wax the paintwork once or twice a year.

CLEANING THE INTERIOR

Seat belts

WARNINGS



Do not use abrasives, or chemical solvents to clean them.



Do not allow moisture to penetrate the seat belt retractor mechanism.

Clean the seat belts with interior cleaner or water applied with a soft sponge. Let the seat belts dry naturally, away from artificial heat.

Vehicle care

Instrument cluster screens, LCD screens, radio screens

WARNING



Do not use abrasives, alcoholic solvents or chemical solvents to clean them.

REPAIRING MINOR PAINT DAMAGE

CAUTION



Remove apparently harmless looking substances from the paintwork immediately (e.g. bird droppings, tree resins, insect remains, tar spots, road salt and industrial fall out).

You should repair paintwork damage caused by stones from the road or minor scratches as soon as possible. A choice of products is available from your Ford Dealer. Read and follow the manufacturer's instructions.

Vehicle battery

USING BOOSTER CABLES

CAUTIONS

- ⚠ Connect batteries with only the same nominal voltage.
- ⚠ Always use booster cables with insulated clamps and adequate size cable.
- ⚠ Do not disconnect the battery from the vehicle's electrical system.

To connect the booster cables

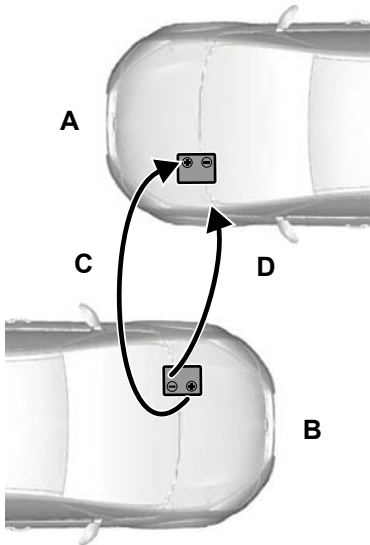

E102925

- A Flat battery vehicle
- B Booster battery vehicle
- C Positive connection cable
- D Negative connection cable

1. Position the vehicles so that they do not touch one another.
2. Switch off the engine and any electrical equipment.
3. Connect the positive (+) terminal of vehicle **B** with the positive (+) terminal of vehicle **A** (cable **C**).
4. Connect the negative (-) terminal of vehicle **B** to the ground connection of vehicle **A** (cable **D**). See **Battery connection points** (page 223).

CAUTIONS

- ⚠ **Do not connect to the negative (-) terminal of the flat battery.**
- ⚠ Make sure that the cables are clear of any moving parts.

To start the engine

1. Run the engine of vehicle **B** at moderately high speed.
2. Start the engine of vehicle **A**.
3. Run both vehicles for a minimum of three minutes before disconnecting the cables.

CAUTION

- ⚠ Do not switch on the headlamps when disconnecting the cables. The peak voltage could blow the bulbs.

Disconnect the cables in the reverse order.

Vehicle battery

BATTERY CONNECTION POINTS

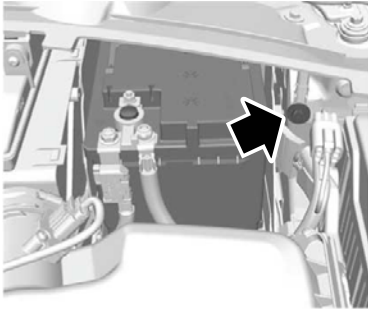

E114494

CAUTION

 **Do not connect to the negative (-) terminal of the flat battery.**

Wheels and tyres

GENERAL INFORMATION

CAUTIONS

! Use only approved wheel and tyre sizes. Using other sizes could damage the vehicle and will make the National Type Approval invalid.

! If you change the diameter of the tyres from that fitted at the factory, the speedometer may not display the correct speed. Take the vehicle to your dealer to have the engine management system reprogrammed.

A decal with tyre pressure data is located in the driver's door opening at the B-pillar.

Check and set the tyre pressure at the ambient temperature in which you are intending to drive the vehicle and when the tyres are cold.

CHANGING A ROAD WHEEL

Locking wheel nuts

You can obtain a replacement locking wheel nut key and replacement locking wheel nuts from your dealer using the reference number certificate.

Vehicle jack

Your vehicle is not equipped with a vehicle jack or a wheel brace.

It is recommended to use a workshop type hydraulic jack for changing between summer and winter tyres.

Jacking and lifting points

WARNING

! Never place anything between the jack and the ground, or the jack and the vehicle.

CAUTION

! Use only the specified jacking points. If you use other positions, you may damage the body, steering, suspension, engine, braking system or the fuel lines.

Note: Use a jack with a minimum lifting capacity of 1.5 tonnes and a lifting plate with a minimum diameter of 80 millimetres (3.1 inches).

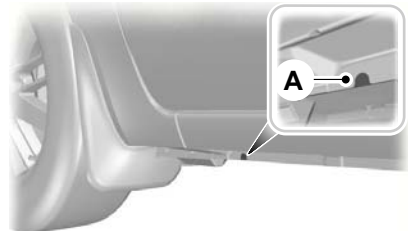
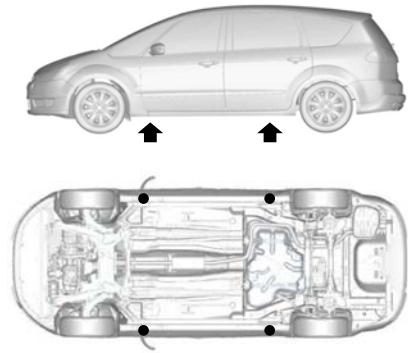

E90708

Indentations in the sills **A** show the location of the jacking points.

Wheels and tyres



E93020

Vehicles with side skirts

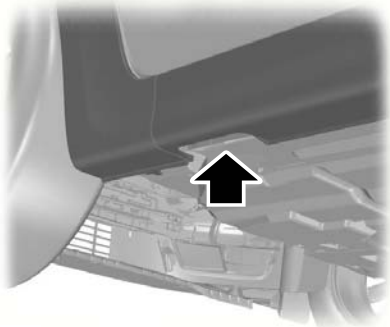



E90709









Place the lifting plate through the cut out on the underside of the skirt.

Removing a road wheel

WARNINGS

-  Park your vehicle in such a position that neither the traffic nor you are hindered or endangered.
-  Set up a warning triangle.

WARNINGS

-  Make sure that the vehicle is on firm, level ground with the wheels pointing straight ahead.
-  Switch off the ignition and apply the parking brake.
-  If your vehicle has a manual transmission, select first or reverse gear. If it has an automatic transmission, select park.
-  Have the passengers leave the vehicle.
-  Secure the diagonally opposite wheel with an appropriate block or wheel chock.
-  Make sure that the arrows on directional tyres point in the direction of rotation when the vehicle is moving forwards. If you have to fit a spare wheel with the arrows pointing in the opposite direction, have the tyre refitted in the correct direction by a properly trained technician.
-  Do not work underneath the vehicle when it is supported only by a jack.
-  Make sure that the jack is vertical to the jacking point and the base is flat on the ground.

CAUTION

-  Do not lay alloy wheels face down on the ground, this will damage the paint.

1. Remove the hub cap or cover.

Wheels and tyres



E71948

2. Install the locking wheel nut key.
3. Slacken the wheel nuts.
4. Jack up the vehicle until the tyre is clear of the ground.
5. Remove the wheel nuts and the wheel.

Installing a road wheel

WARNINGS

 Use only approved wheel and tyre sizes. Using other sizes could damage the vehicle and will make the National Type Approval invalid. See **Technical specifications** (page 235).

 Do not fit run flat tyres on vehicles that were not originally fitted with them. Please contact your dealer for more details regarding compatibility.

CAUTION

 Do not install alloy wheels using wheel nuts designed for use with steel wheels.

Note: You can use wheel nuts designed for use with alloy wheels with steel wheels.

Note: Make sure the wheel and hub contact surfaces are free from foreign matter.

Note: Make sure that the cones on the wheel nuts are against the wheel.

1. Install the wheel.
2. Install the wheel nuts finger tight.



E71948

3. Install the locking wheel nut key.

Wheels and tyres

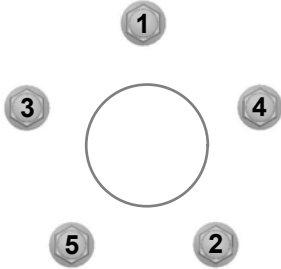

E75442

- Partially tighten the wheel nuts in the sequence shown.
- Lower the vehicle and remove the jack.
- Fully tighten the wheel nuts in the sequence shown. See **Technical specifications** (page 235).
- Install the hub cap or cover using the ball of your hand.

WARNING



Have the wheel nuts checked for tightness and the tyre pressure checked as soon as possible.

TYRE REPAIR KIT

Your vehicle is not equipped with a spare tyre, but does include an emergency tyre repair kit that can be used to repair **one** flat tyre.

The tyre repair kit is located in the underfloor storage compartment. See **Storage compartments** (page 131).

General information

WARNINGS



Depending on the type and extent of tyre damage, some tyres can only be partially sealed or not sealed at all. Loss of tyre pressure can affect vehicle handling, leading to loss of vehicle control.



Do not use the tyre repair kit if the tyre has already been damaged as a result of being driven under inflated.



Do not try to seal damage other than that located within the visible tread of the tyre.



Do not try to seal damage to the tyre's sidewall.

The tyre repair kit seals most tyre punctures [with a diameter of up to six millimetres (1/4 inch)] to temporarily restore mobility.



Observe the following rules when using the kit:

- **Drive with caution and avoid making sudden steering or driving manoeuvres**, especially if the vehicle is heavily loaded or you are towing a trailer.
- The kit will provide you with an emergency temporary repair, enabling you to continue your journey to the next vehicle or tyre dealer, or to drive a maximum distance of 200 kilometres (125 miles).
- Do not exceed a **maximum speed of 80 km/h (50 mph)**.
- Keep the kit out of the reach of children.
- Only use the kit when the ambient temperature is between -30°C (-22°F) and $+70^{\circ}\text{C}$ ($+158^{\circ}\text{F}$).

Wheels and tyres

Using the tyre repair kit

WARNINGS

-  Compressed air can act as an explosive or propellant.
-  Never leave the tyre repair kit unattended while in use.

CAUTION



-  Do not keep the compressor operating for more than 10 minutes.

Note: Use the tyre repair kit only for the vehicle with which it was supplied.

- Park your vehicle at the roadside so that you do not obstruct the flow of traffic and so that you are able to use the kit without being in danger.
- Apply the parking brake, even if you have parked on a level road, to make sure that the vehicle will not move.
- Do not attempt to remove foreign objects like nails or screws penetrating the tyre.
- Leave the engine running while the kit is in use, but not if the vehicle is in an enclosed or poorly ventilated area (for example, inside a building). In these circumstances, switch the compressor on with the engine turned off.
- Replace the sealant bottle with a new one before the expiry date (see top of bottle) is reached.
- Inform all other users of the vehicle that the tyre has been temporarily sealed with the tyre repair kit and make them aware of the special driving conditions to be observed.

Inflating the tyre

WARNINGS

-  Check the sidewall of the tyre prior to inflation. If there are any cracks, bumps or similar damage, do not attempt to inflate the tyre.
-  Do not stand directly beside the tyre while the compressor is pumping.
-  Watch the sidewall of the tyre. If any cracks, bumps or similar damage appear, turn off the compressor and let the air out by means of the pressure relief valve **B**. Do not continue driving with this tyre.

 The sealant contains natural rubber latex. Avoid contact with skin and clothing. If this happens, rinse the affected areas immediately with plenty of water and contact your doctor.

 If the tyre inflation pressure does not reach 1.8 bar (26 psi) within seven minutes, the tyre may have suffered excessive damage, making a temporary repair impossible. In this case, do not continue driving with this tyre.

CAUTION

-  Screwing the bottle onto the bottle holder will pierce the seal of the bottle. Do not unscrew the bottle from the holder as the sealant will escape.

Wheels and tyres

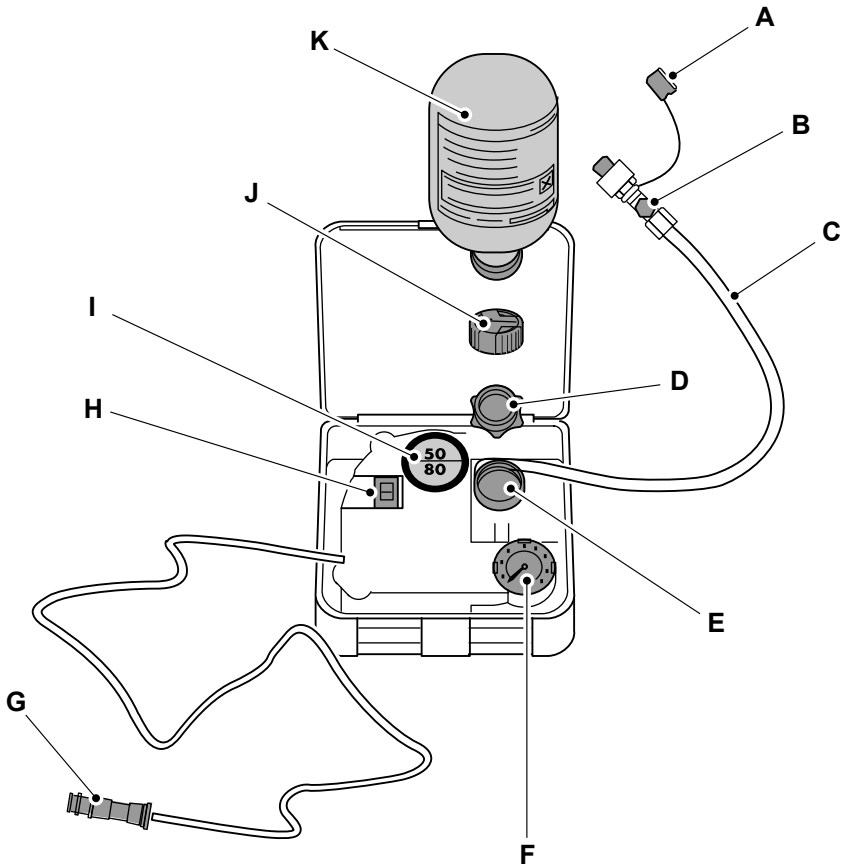

E94973

- A Protective cap
- B Pressure relief valve
- C Hose
- D Orange cap

Wheels and tyres

- E Bottle holder
- F Pressure gauge
- G Power plug with cable
- H Compressor switch
- I Label
- J Bottle lid
- K Sealant bottle

1. Open the lid of the tyre repair kit.
2. Peel off the label **I** showing the maximum permissible speed of 80 km/h (50 mph) from the casing and attach it to the instrument panel in the driver's field of view. Make sure the label does not obscure anything important.
3. Take the hose **C** and the power plug with cable **G** out of the kit.
4. Unscrew the orange cap **D** and the bottle lid **J**.
5. Screw the sealant bottle **K** clockwise into the bottle holder **E** fully tight.
6. Remove the valve cap from the damaged tyre.
7. Detach the protective cap **A** from the hose **C** and screw the hose **C** firmly onto the valve of the damaged tyre.
8. Make sure that the compressor switch **H** is in position **O**.
9. Insert the power plug **G** into the cigar lighter socket or auxiliary power socket. See **Cigar lighter** (page 129). See **Auxiliary power sockets** (page 129).
10. Start the engine.
11. Move the compressor switch **H** to position **1**.
12. Inflate the tyre for no longer than seven minutes to an inflation pressure of minimum 1.8 bar (26 psi) and a maximum of 3.5 bar (51 psi). Move the compressor switch **H** to position **O** and check the current tyre pressure with pressure gauge **F**.
13. Remove the power plug **G** from the cigar lighter socket or auxiliary power socket.
14. Quickly unscrew the hose **C** from the tyre valve and replace the protective cap **A**. Fasten the valve cap again.
15. Leave the sealant bottle **K** in the bottle holder **E**.
16. Make sure the kit, the bottle lid and the orange cap are stored safely, but still easily accessible in the vehicle. The kit will be required again when you check the tyre pressure.
17. Immediately drive approximately three kilometres (two miles) so that the sealant can seal the damaged area.

Note: *When pumping in the sealant through the tyre valve, the pressure may rise up to 6 bar (87 psi) but will drop again after about 30 seconds.*

Wheels and tyres

WARNING



If you experience heavy vibrations, unsteady steering behaviour or noises while driving, reduce your speed and drive with caution to a place where it is safe for you to stop the vehicle. Recheck the tyre and its pressure. If the tyre pressure is less than 1.3 bar (19 psi) or if there are any cracks, bumps or similar damage visible, do not continue driving with this tyre.

Checking the tyre pressure

1. Stop the vehicle after driving approximately three kilometres (two miles). Check, and where necessary, adjust the pressure of the damaged tyre.
2. Attach the kit and read the tyre pressure from the pressure gauge **F**.
3. If the pressure of the sealant-filled tyre is 1.3 bar (19 psi) or more, adjust it to the specified pressure. See **Technical specifications** (page 235).
4. Follow the inflation procedure once again to top up the tyre.
5. Check the tyre pressure again from the pressure gauge **F**. If the tyre pressure is too high, deflate the tyre to the specified pressure using the pressure relief valve **B**.
6. Once you have inflated the tyre to its correct tyre pressure, move the compressor switch **H** to position **O**, remove the power plug **G** from the socket, unscrew the hose **C**, fasten the valve cap and replace the protective cap **A**.
7. Leave the sealant bottle **K** in the bottle holder **E** and store the kit away safely in its original location.

8. Drive to the nearest tyre specialist to get the damaged tyre replaced. Before the tyre is removed from the rim, inform your tyre dealer that the tyre contains sealant. Renew the kit as soon as possible after it has been used once.

Note: Remember that emergency roadside tyre repair kits only provide temporary mobility. Regulations concerning tyre repair after usage of tyre repair kit may differ from country to country. You should consult a tyre specialist for advice.

WARNING



Before driving, make sure the tyre is adjusted to the recommended inflation pressure. See **Technical specifications** (page 235). Monitor the tyre pressure until the sealed tyre is replaced.

Empty sealant bottles can be disposed of together with normal household waste. Return remains of sealant to your dealer or dispose of it in compliance with local waste disposal regulations.

Wheels and tyres

RUN FLAT TYRES

Principle of operation

Standard tyre

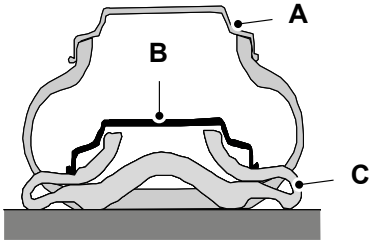

E75207

- A Wheel rim position with correct tyre pressure
- B Wheel rim position with insufficient tyre pressure
- C Tyre

Run flat tyre

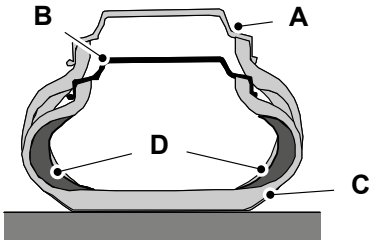

E87667

- A Wheel rim position with correct tyre pressure
- B Wheel rim position with insufficient tyre pressure
- C Tyre
- D Reinforced sidewall

When a standard tyre experiences a drastic loss of inflation pressure, the rim of the wheel brings the full weight of the vehicle to bear on the collapsed sidewalls. You can barely manoeuvre the vehicle and the tyre is destroyed.

Run flat tyres have sturdy, reinforced sidewalls that support the rim should the tyre suffer a loss of inflation pressure.

What to do if a run flat tyre has a puncture



Due to the run-flat properties of these tyres, you may not notice any tyre defect. Your vehicle is equipped with a tyre pressure monitoring system that alerts you to any drop in tyre pressure. See **Technical specifications** (page 235).

In the event of a tyre defect:

- immediately slow down to a maximum speed of 80 km/h (50 mph)
- avoid sudden or erratic braking and steering manoeuvres and be especially careful negotiating bends
- do not drive more than 80 kilometres (50 miles) after the defect is detected
- have the defective tyre replaced as soon as possible.

Replacing run flat tyres

WARNINGS

-  Make sure that the workshop is aware that your vehicle is equipped with special run flat tyres.
-  Never repair or reuse run flat tyres that are damaged or have been driven on run flat.

If a run flat tyre has to be replaced, have the respective wheel rim inspected for any damage.

Wheels and tyres

WARNINGS



Do not fit a mixture of run flat and standard tyres. In isolated cases, a standard tyre can be temporarily mounted on a vehicle otherwise equipped with run flat tyres. It must be pointed out to the driver that the standard tyre has no runflat properties.



Do not fit run flat tyres on vehicles that were not originally fitted with them. Please contact your dealer for more details regarding compatibility.

Run flat tyres may be sold and mounted only by specially trained and certified tyre dealers.

TYRE CARE



E70415

To make sure the front and rear tyres of your vehicle wear evenly and last longer, we recommend that you swap the tyres from front to rear and vice versa at regular intervals of between 5 000 and 10 000 km (3 000 and 6 000 miles).

CAUTION



Do not scrub the sidewalls of the tyres when you are parking.

If you have to mount a kerb, do so slowly and approach it with the wheels at right-angles to the kerb.

Examine the tyres regularly for cuts, foreign objects and uneven wear of the tread. Uneven wear could mean that the wheel alignment is outside specification.

Check the tyre pressures (including the spare) when cold, every two weeks.

USING WINTER TYRES

CAUTION



Make sure that you use the correct wheel nuts for the type of wheel the winter tyres are fitted to.

If winter tyres are used, make sure that the tyre pressures are correct. See **Technical specifications** (page 235).

USING SNOW CHAINS

WARNINGS



Do not exceed 50 km/h (30 mph).



Do not use snow chains on snow-free roads.



Do not fit snow chains to 225/50 R 17 or 235/45 R 18 tyres.

CAUTION



If your vehicle is fitted with wheel trims, remove them before fitting snow chains.

Note: *The ABS will continue to operate normally.*

Only use small link snow chains.

Only use snow chains on the front wheels.

Wheels and tyres

TYRE PRESSURE MONITORING SYSTEM

WARNINGS



The system does not relieve you of your responsibility to regularly check the tyre pressures.



The system will only provide a low tyre pressure warning. It will not inflate the tyres.



The system may take longer to detect low pressure in the tyres if you have fitted snow chains.



Do not drive on significantly under-inflated tyres. This may cause the tyres to overheat and fail.

Under-inflation reduces fuel efficiency, tyre tread life and may also affect your ability to drive the vehicle safely.

CAUTIONS



Do not bend or damage the valves when you are inflating the tyres.



Have tyres installed by properly trained technicians.

The system monitors the pressure in the tyres using sensors located on the wheels and a receiver located in your vehicle. When the system detects low pressure in the tyres, a warning message is displayed in the information display. See **Information messages** (page 95).

If a low pressure warning message is displayed in the information display, check the tyre pressures as soon as possible and inflate them to the recommended pressure. See **Technical specifications** (page 235). If this happens frequently, have the cause determined and rectified as soon as possible.

Checking the tyre pressures

Note: If the tyre pressures are greater than or equal to 3.3 bar (48 lbf/in²), you will see the + symbol below the pressure value. The system only measures pressure up to 3.3 bar (48 lbf/in²). The + symbol indicates that the tyre pressures may be higher.

Note: Type 3 instrument clusters have a slightly different menu structure. Select **Settings** first to access **Information**.

1. Press the right arrow button on the steering wheel to enter the main menu.
2. Highlight **Information** with the up and down buttons and press the right arrow button.
3. Highlight **Tyre Pressures** with the up and down buttons and press the right arrow button.
4. Highlight the desired setting and press the **OK** button to confirm the setting.
5. Press the left arrow button to exit the menu. Hold the left arrow button pressed to return to the trip computer display.

Setting the vehicle load

Note: Type 3 instrument clusters have a slightly different menu structure. Select **Settings** first to access **Setup**.

Correct tyre pressure settings depend on vehicle load. See **Technical specifications** (page 235). The system can only detect low pressure if you have entered the current vehicle load.

1. Press the right arrow button on the steering wheel to enter the main menu.
2. Highlight **Setup** with the up and down buttons and press the right arrow button.

Wheels and tyres

3. Highlight **Tyre Pressures** with the up and down buttons and press the right arrow button.
4. Highlight the desired setting and press the **OK** button to confirm the setting.
5. Press the left arrow button to exit the menu. Hold the left arrow button pressed to return to the trip computer display.

TECHNICAL SPECIFICATIONS

Wheel nut torque

| Wheel type | Nm (lb-ft) |
|------------|------------|
| All | 170 (125) |

Tyre pressures (cold tyres)

Up to 160 km/h (100 mph)

Tyre pressures

| Variant | Tyre size | Normal load | | Full load | |
|--|-------------|----------------------------|----------------------------|----------------------------|----------------------------|
| | | Front | Rear | Front | Rear |
| | | bar (lbf/in ²) | bar (lbf/in ²) | bar (lbf/in ²) | bar (lbf/in ²) |
| 2.0L Duratec-HE and 2.3L Duratec-HE | 215/60 R 16 | 2.2 (32) | 2.4 (35) | 2.6 (38) | 3.1 (45) |
| 2.0L Duratec-HE and 2.3L Duratec-HE | 225/50 R 17 | 2.2 (32) | 2.2 (32) | 2.6 (38) | 3.1 (45) |
| 2.0L Duratec-HE and 2.3L Duratec-HE | 235/45 R 18 | 2.2 (32) | 2.2 (32) | 2.6 (38) | 3.1 (45) |
| All except 2.0L Duratec-HE and 2.3L Duratec-HE | 215/60 R 16 | 2.4 (35) | 2.4 (35) | 2.6 (38) | 3.1 (45) |
| All except 2.0L Duratec-HE and 2.3L Duratec-HE | 225/50 R 17 | 2.4 (35) | 2.2 (32) | 2.6 (38) | 3.1 (45) |

Wheels and tyres

| Variant | Tyre size | Normal load | | Full load | |
|--|-------------|----------------------------|----------------------------|----------------------------|----------------------------|
| | | Front | Rear | Front | Rear |
| | | bar (lbf/in ²) | bar (lbf/in ²) | bar (lbf/in ²) | bar (lbf/in ²) |
| All except 2.0L Duratec-HE and 2.3L Duratec-HE | 235/45 R 18 | 2.4 (35) | 2.2 (32) | 2.6 (38) | 3.1 (45) |

Continuous speed in excess of 160 km/h (100 mph)

Tyre pressures

| Variant | Tyre size | Normal load | | Full load | |
|---|-------------|----------------------------|----------------------------|----------------------------|----------------------------|
| | | Front | Rear | Front | Rear |
| | | bar (lbf/in ²) | bar (lbf/in ²) | bar (lbf/in ²) | bar (lbf/in ²) |
| 2.0L Duratec-HE and 2.3L Duratec-HE | 215/60 R 16 | 2.2 (32) | 2.4 (35) | 2.6 (38) | 3.1 (45) |
| 2.0L Duratec-HE and 2.3L Duratec-HE | 225/50 R 17 | 2.2 (32) | 2.2 (32) | 2.6 (38) | 3.1 (45) |
| 2.0L Duratec-HE and 2.3L Duratec-HE | 235/45 R 18 | 2.2 (32) | 2.2 (32) | 2.6 (38) | 3.1 (45) |
| 2.5L Duratec-ST | 215/60 R 16 | 2.6 (38) | 2.6 (38) | 2.8 (41) | 3.2 (46) |
| 2.5L Duratec-ST | 225/50 R 17 | 2.6 (38) | 2.6 (38) | 2.8 (41) | 3.2 (46) |
| 2.5L Duratec-ST | 235/45 R 18 | 2.6 (38) | 2.6 (38) | 2.8 (41) | 3.2 (46) |
| 1.8L Duratorq-TDCi and 2.0L Duratorq-TDCi | 215/60 R 16 | 2.4 (35) | 2.4 (35) | 2.6 (38) | 3.1 (45) |
| 1.8L Duratorq-TDCi and 2.0L Duratorq-TDCi | 225/50 R 17 | 2.4 (35) | 2.2 (32) | 2.6 (38) | 3.1 (45) |
| 1.8L Duratorq-TDCi and 2.0L Duratorq-TDCi | 235/45 R 18 | 2.4 (35) | 2.2 (32) | 2.6 (38) | 3.1 (45) |
| 2.2L Duratorq-TDCi | 215/60 R 16 | 2.5 (36) | 2.4 (35) | 2.6 (38) | 3.1 (45) |

Wheels and tyres

| Variant | Tyre size | Normal load | | Full load | |
|--------------------|-------------|-------------------------------|-------------------------------|-------------------------------|-------------------------------|
| | | Front | Rear | Front | Rear |
| | | bar (lbf/in ²) | bar (lbf/in ²) | bar (lbf/in ²) | bar (lbf/in ²) |
| 2.2L Duratorq-TDCi | 225/50 R 17 | 2.5 (36) | 2.3 (33) | 2.6 (38) | 3.1 (45) |
| 2.2L Duratorq-TDCi | 235/45 R 18 | 2.5 (36) | 2.3 (33) | 2.6 (38) | 3.1 (45) |

Vehicle identification

VEHICLE IDENTIFICATION PLATE

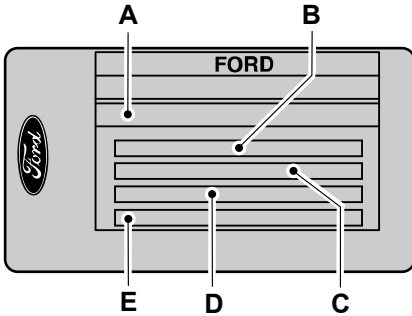

E85610

- A Vehicle identification number
- B Gross vehicle weight
- C Gross train weight
- D Maximum front axle weight
- E Maximum rear axle weight

The vehicle identification number and maximum weights are shown on a plate located on the lock side of the passenger door aperture at the bottom.

VEHICLE IDENTIFICATION NUMBER (VIN)

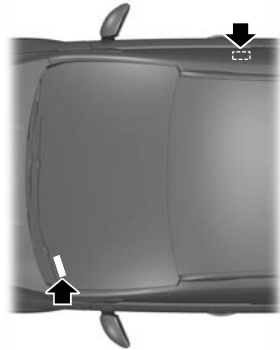

E87496

The vehicle identification number is stamped into the floor panel on the right-hand side, beside the front seat. It is also shown on the left-hand side of the instrument panel.

Technical specifications

TECHNICAL SPECIFICATIONS

Vehicle dimensions

S-MAX

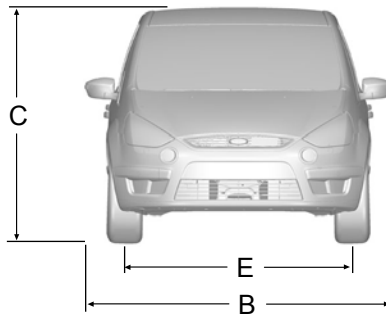
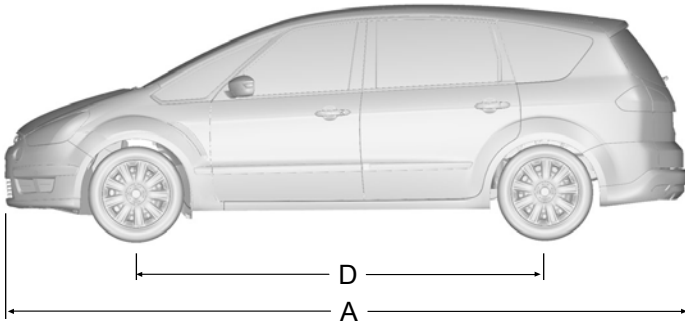

E75180

| Item | Dimension description | Dimension in mm (inches) |
|------|--|-----------------------------|
| A | Maximum length | 4 768 (187.7) |
| B | Overall width including exterior mirrors | 2 154 (84.8) |
| C | Overall height at EC kerb weight | 1 610 - 1 658 (63.4 - 65.3) |

Technical specifications

| Item | Dimension description | Dimension in mm (inches) |
|------|-----------------------|-----------------------------|
| D | Wheelbase | 2 850 (112.2) |
| E | Front track | 1 578 - 1 588 (62.1 - 62.5) |
| E | Rear track | 1 600 - 1 610 (63 - 63.4) |

Galaxy

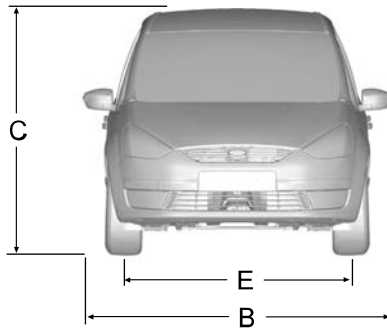
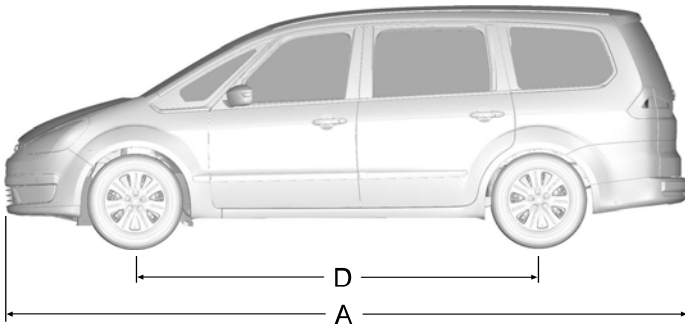

E76860

Technical specifications

| Item | Dimension description | Dimension in mm (inches) |
|-------------|--|-------------------------------------|
| A | Maximum length | 4 820 (189.8) |
| B | Overall width including exterior mirrors | 2 154 (84.8) |
| C | Overall height at EC kerb weight without roof bars | 1 691 - 1 764 (66.6 - 69.4) |
| C | Overall height at EC kerb weight including roof bars | 1 770 - 1 807 (69.7 - 71.1) |
| D | Wheelbase | 2 850 (112.2) |
| E | Front track | 1 578 - 1 588 (62.1 - 62.5) |
| E | Rear track | 1 600 - 1 610 (63 - 63.4) |

Technical specifications

Towing equipment dimensions

S-MAX

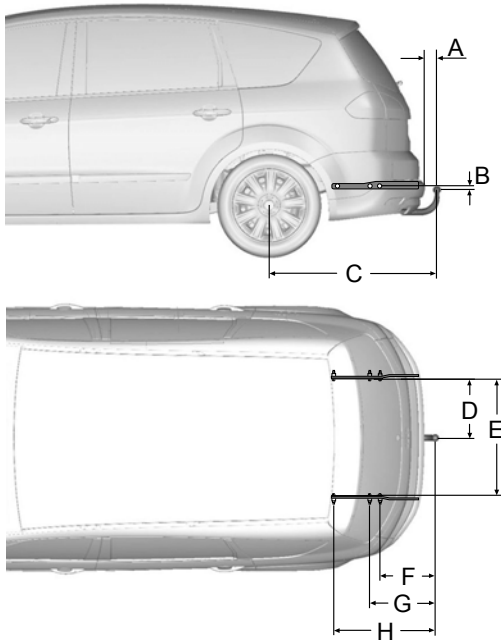

E75182

| Item | Dimension description | Dimension in mm (inches) |
|------|---|-----------------------------|
| A | Bumper – end of tow ball | 102 (4.02) |
| B | Attachment point – centre of tow ball | 16 (0.63) |
| C | Wheel centre – centre of tow ball | 1 079 (42.48) |
| D | Centre of tow ball – side member | 438 (17.24) |
| E | Inner side of side member | 876 (34.49) |
| F | Centre of tow ball – centre 1. attachment point | 363 (14.29) |

Technical specifications

| Item | Dimension description | Dimension in mm (inches) |
|------|---|--------------------------|
| G | Centre of tow ball – centre 2. attachment point | 424 (16.69) |
| H | Centre of tow ball – centre 3. attachment point | 636 (25.04) |

Galaxy

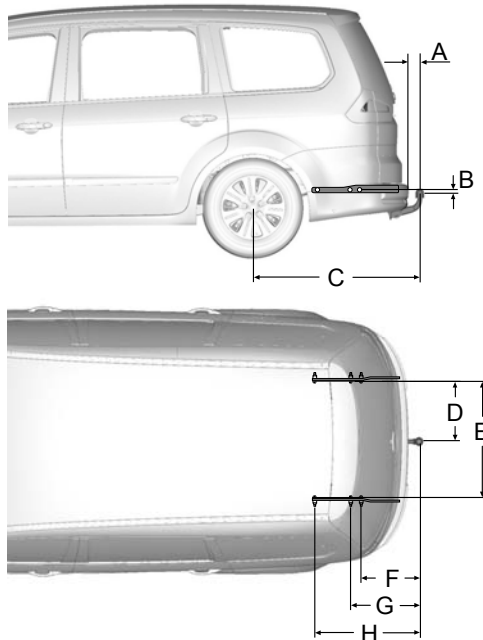

E75181

| Item | Dimension description | Dimension in mm (inches) |
|------|---------------------------------------|--------------------------|
| A | Bumper – end of tow ball | 101 (3.98) |
| B | Attachment point – centre of tow ball | 16 (0.63) |
| C | Wheel centre – centre of tow ball | 1 128 (44.41) |

Technical specifications

| Item | Dimension description | Dimension in mm (inches) |
|-------------|---|-------------------------------------|
| D | Centre of tow ball – side member | 438 (17.24) |
| E | Inner side of side member | 876 (34.49) |
| F | Centre of tow ball – centre 1. attachment point | 412 (16.22) |
| G | Centre of tow ball – centre 2. attachment point | 473 (18.62) |
| H | Centre of tow ball – centre 3. attachment point | 685 (26.97) |

Telephone

GENERAL INFORMATION

CAUTION

 Using the system with the engine off will drain the battery.

This section describes the functions and features of the Bluetooth mobile phone hands free system.

The Bluetooth mobile phone part of the system provides interaction with the audio or navigation system and your mobile phone. It allows you to use the audio or navigation system to make and receive calls without having to use your mobile phone.

Compatibility of phones

CAUTION

 As no common agreement exists, mobile phone manufacturers are able to implement a variety of profiles in their Bluetooth devices. Because of this, an incompatibility can occur between the phone and hands-free system, which in some cases may significantly degrade the system performance. To avoid this situation, only recommended phones should be used.

Please visit the website www.ford-mobile-connectivity.com for full details.

Phones with Symbian operating system

Note: Certain phones require a special file to be installed to enable full phonebook access via Bluetooth.

This is referred to as a SIS file and will be available to download via the Ford website www.ford-mobile-connectivity.com.

TELEPHONE SETUP

Phonebook

Note: It may be necessary to confirm phonebook access to the Bluetooth system via the mobile phone.

After start up access to the phonebook list can be delayed for several minutes, depending upon the size.

Phonebook categories

Depending on your phonebook entry, different categories can be displayed in the audio unit.

For example:

| | |
|---|--------|
| M | Mobile |
| O | Office |
| H | Home |
| F | Fax |

Note: Entries may be displayed without a category attachment.

The category can also be indicated as an icon:



Telephone

Making a phone an active phone

When using the system for the first time, no phone is connected to the system.

After switching on the ignition and the audio unit, the Bluetooth phone must be bonded to the system.

Bluetooth phone

After bonding a Bluetooth phone to the system, this becomes the active phone. For further information refer to the phone menu.

Select the phone from the active phone menu.

Turning the ignition and radio or navigation unit back on again, the last active phone is picked up by the system.

Note: *In some cases the Bluetooth connection must also be confirmed on the phone.*

Bond another Bluetooth phone

Bond a new Bluetooth phone as described in the requirements for a Bluetooth connection.

Phones stored in the system are accessible by using the phone list on the audio unit.

Note: *A maximum of six devices may be bonded. If six Bluetooth devices have already been bonded, one of these has to be debonded in order to bond a new device.*

BLUETOOTH SETUP

Before you can use your telephone with your vehicle it must be bonded to the vehicle telephone system.

Handling of phones

Up to six Bluetooth devices can be bonded to the vehicle system.

Note: *If there is an ongoing call when the phone in use is selected as the new active phone, the call is transferred to the vehicle audio system.*

Note: *Even if connected to the car system, your phone can still be used in the usual way.*

Requirements for Bluetooth connection

The following are required before a Bluetooth phone connection can be made.

1. The Bluetooth feature must be activated on the phone and on the audio unit. Make sure the Bluetooth menu option in the audio unit is set to **ON**. For information on phone settings, refer to your phone user guide.
2. The private mode must not be activated on the Bluetooth phone.
3. Search for audio device.
4. Select **Ford Audio**.
5. Enter the code number shown on the vehicle display using the phone keypad. If no code number is shown on the display, enter the Bluetooth PIN number 0000 using the phone keypad. Now enter the Bluetooth PIN number shown on the vehicle display.

Note: *A phone call will be disconnected if the audio unit is switched off. If the ignition key is turned to the off position the phone call will remain in progress.*

Telephone

TELEPHONE CONTROLS

Remote control

Voice, accept and reject button

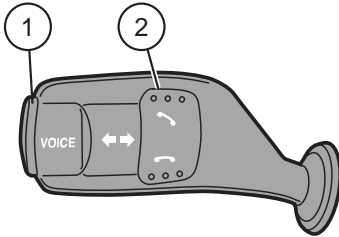

E87662

- 1 Voice button
- 2 Accept and reject button

The VOICE button is used to activate or switch off the Voice control.

On vehicles with an accept and reject button, phone calls can be accepted and rejected by pressing the appropriate button.

Note: Some audio units have the accept and reject buttons on the front bezel. These operate in the same way.

USING THE TELEPHONE - VEHICLES WITHOUT: NAVIGATION SYSTEM

This chapter describes the phone functions of the audio unit.

Note: Refer to your audio guide for details of the controls.

An active phone must be present.

Even if connected to the audio unit, your phone can still be used in the usual way.

Note: You can exit the phone menu by pressing any source button **CD**, **AM/FM** or **AUX**.

Making a call

Dialling a number using voice control

Phone numbers can be dialled using voice control. See **Telephone commands** (page 264).

Dialling a number using the address book

You can access your phone address book via Bluetooth. The entries will appear in the unit display.

1. Press the **PHONE** or the call accept button.
2. Press the **MENU** button.
3. Keep pressing the **MENU** button until **PHONEBOOK** appears.
4. Press the seek buttons to select the desired phone number.

Note: Press and hold the seek button to skip to the next letter in the alphabet.

5. Press the **PHONE** or the call accept button to dial the selected phone number.

Dialling a number using the address book - Sony radio

You can access your phone address book via Bluetooth. The entries will appear in the unit display.

1. Press the **PHONE** button.
2. Press the seek button until the phone book is shown.
3. Press the up/down arrow buttons to select the desired phone number.

Note: Press and hold the up/down arrow buttons to skip to the next letter in the alphabet.

Telephone

4. Press the **PHONE** or the call accept button to dial the selected phone number.

Dialling a number using the telephone keypad

If you have an audio unit with a telephone keypad (buttons 0-9, * and #):

1. Press the call accept button. Press the **PHONE** button if you have a Sony radio.
2. Dial the number using the telephone keypad on the audio unit.
3. Press the call accept button.

Note: *If you enter an incorrect digit whilst entering a phone number, press the seek left button to erase the last digit. A long press will erase the complete string of digits.*

*Press and hold **0** to enter a + digit.*

Ending a call

Calls can be ended by pressing the call reject button.

Audio units without a telephone keypad can also end a call by pressing either **PHONE**, **CD**, **AM/FM** or **ON/OFF**, or by pressing the **MODE** button on the remote control

Redialling a number

1. Press the **PHONE** or the call accept button.
2. Press the **MENU** button.
3. Select the **CALL OUT** list or the **CALL IN** list. On some audio units, select the **MISSED**, **INCOMING** or **OUTGOING** calls list.

Note: *If the active phone does not provide a call out list, the last outgoing call number/entry can be redialled.*

4. Press the seek button on the audio unit.

5. Press the **PHONE** or the call accept button to dial the desired phone number.

Redialling a number - Sony radio

1. Press the **PHONE** or the call accept button.
2. Press the seek button until the desired list is displayed.

Note: *If the active phone does not provide a call out list, the last outgoing call number/entry can be redialled.*

3. Press the up/down buttons to select the desired phone number.
4. Press the **PHONE** or the call accept button to dial the phone number.

Redialling the last dialled number - Sony radio

1. Press the call accept button.
2. Press the call accept button a second time to dial the number.

Receiving an incoming call

Accepting an incoming call

Incoming calls can be accepted by pressing either the call accept button, the **PHONE** button or the **MODE** button on the remote control.

Rejecting an incoming call

Incoming calls can be rejected by pressing the call reject button.

Audio units without a telephone keypad can also reject a call by pressing either **PHONE**, **CD**, **AM/FM** or **ON/OFF**.

Receiving a second incoming call

Note: *The second incoming call function must be activated in your phone.*

Telephone

If there is an incoming call whilst there is an ongoing call, a beep will be heard and you will have the option to end the active call and to accept the incoming call.

Accepting a second incoming call

Second incoming calls can be accepted by pressing either the call accept button, the **PHONE** button, or the **MODE** button on the remote control.

Rejecting a second incoming call

Second incoming calls can be rejected by pressing the call reject button. Units without a telephone keypad can also reject a second incoming call by pressing the **CD** button, or the **AM/FM** button.

Muting the microphone

During a call, it is possible to mute the microphone. Whilst muted, confirmation will appear in the display.

Audio units with green call accept button

Press the call accept button. Press the button once again to turn this function off.

Audio units without green call accept button

Press the seek up or down button. Press the button once again to turn this function off.

Changing the active phone

Note: *Phones must be bonded to the system before they can be made active.*

Using the station storage button

Note: *This process is only for audio units without a telephone keypad.*

1. Press the **PHONE** button on the audio unit.

2. Press the preset number required (using the station preset buttons 1 - 6).

Using the audio unit menu

Note: *After bonding a phone to the system, this becomes the active phone.*

1. Press the **PHONE** or call accept button.
2. Press the **MENU** button on the audio unit.
3. Select the **ACTIVE PHONE** option on the audio unit.
4. Scroll through the different stored phones by using the seek buttons to display the bonded phones.
5. Press the **MENU** button to select the phone which is to be the active phone.

Debonding a bonded phone

A bonded phone can be deleted from the system at any time, unless a phone call is in progress.

1. Press the **PHONE** or call accept button.
2. Press the **MENU** button on the audio unit.
3. Select the **DEBOND** option on the audio unit.
4. Scroll through the different phones by using the seek buttons and display the phone to be debonded.
5. Press the **MENU** button to select the phone which is to be debonded.

Debonding a bonded phone - Sony radio

A bonded phone can be deleted from the system at any time, unless a phone call is in progress.

1. Press the **PHONE** button.

Telephone

2. Press the up/down arrow buttons until you reach the **DEBOND** option.
3. Scroll through the different phones by using the seek buttons and display the phone to be debonded.
4. Press the OK button to be debond.

USING THE TELEPHONE - VEHICLES WITH: NAVIGATION SYSTEM

This chapter describes the phone functions of the Navigation System.

Note: Refer to your *Navigation System guide* for details of the controls.

An active phone must be present.

Even if connected to the Navigation System, your phone can still be used in the usual way.

Making a call

Dialling a number

Phone numbers can be dialled using voice control. See **Voice control** (page 252).

Ending a call

Calls can be ended by pressing either the **END** button, the **MODE** button on the remote switch or the **ON/OFF** button on the navigation system.

Redialling a number

1. Press the **PHONE** button on the unit.
2. Select **REDIAL**.

Receiving an incoming call

Accepting an incoming call

Incoming calls can be accepted by pressing either the call accept button, the **MODE** button on the remote control, the **PHONE** button on the unit or by using the **ACCEPT** option in the menu.

Rejecting an incoming call

Incoming calls can be rejected by pressing either the call reject button, the **CD** or **AM/FM** buttons on the unit, or by using the **REJECT** option in the menu.

Receiving a second incoming call

Note: The second incoming call function must be activated in your phone.

If there is an incoming call, whilst there is an ongoing call, a beep will be heard and you will have the option to end the active call and to accept the incoming call.

Accepting a second incoming call

Second incoming calls can be accepted by pressing either the call accept button, the **MODE** button on the remote control, the **PHONE** button on the unit or by using the **ACCEPT** option in the menu.

Note: This will cancel the ongoing call.

Rejecting a second incoming call

Second incoming calls can be rejected by pressing either the call reject button, or one of the following buttons on the unit: **CD**, **AM/FM**.

Muting the microphone

During a call, it is possible to mute the microphone. Whilst muted, confirmation will appear in the display.

Telephone

DVD navigation units

Press the mute button (symbol of a microphone with a line through it). Press the button once again to turn this function off.

CD navigation units

Press the microphone mute button. Press the button once again to turn this function off.

Changing the active phone

Note: *Phones must be bonded to the system before they can be made active.*

Note: *After bonding a phone to the system, this becomes the active phone.*

1. Press the **PHONE** button on the unit.
2. Using the **BT SETTINGS** option in the menu, select the active phone from the list.

Debonding a bonded phone

A bonded phone can be deleted from the system at any time, unless a phone call is in progress.

1. Press the **PHONE** button on the unit.
2. Select the **BT SETTINGS** option in the menu.
3. Select the **DEBOND** option in the menu.
4. Select the phone from the list.

Voice control

PRINCIPLE OF OPERATION

CAUTION

 Using the system with the engine off will drain the battery.

Voice recognition enables operation of the system without the need to divert your attention from the road ahead in order to change settings, or receive feedback from the system.

Whenever you issue one of the defined commands with the system active, the voice recognition system converts your command into a control signal for the system. Your inputs take the form of dialogues or commands. You are guided through these dialogues by announcements or questions.

Please familiarise yourself with the functions of the system before using voice recognition.

Supported commands

The voice control system allows you to control the following vehicle functions:

- Bluetooth phone
- radio
- CD Player/CD Changer
- external device (USB)
- external device (iPod)
- SD card
- automatic climate control
- navigation system (DVD units only - refer to separate DVD navigation handbook).

Note: *The voice control system is language specific. If you require the system to operate in another language please consult your dealer.*

System response

As you work through a voice session the system will prompt you with a beep tone each time the system is ready to proceed.

Do not try to give any commands until the beep tone has been heard. The voice control system will repeat each spoken command back to you.

If you are not sure how to continue say "HELP" for assistance or "CANCEL" if you do not wish to continue.

The "HELP" function provides only a subset of the available voice commands. Detailed explanations of all possible voice commands can be found on the following pages.

Voice commands

All voice commands should be given using a natural speaking voice, as if speaking to a passenger or on the phone. Your voice level should be dependant on the surrounding noise level inside or outside the vehicle but do not shout.

USING VOICE CONTROL

System operation

The order and content of the voice controls are given in the following lists. The tables show the sequence of user voice commands and system responses for each available function.

<> indicates a number or stored name tag to be inserted by the user.

Short cuts

There are a number of voice command short cuts available, which allow you to control some vehicle features without having to follow the complete command menu. These are:

Voice control

- phone: "MOBILE NAME", "DIAL NUMBER", "DIAL NAME", and "REDIAL"
- CD player/CD changer: "DISC" and "TRACK"
- automatic climate control: "TEMPERATURE", "AUTO MODE", "DEFROSTING/DEMISTING ON" and "DEFROSTING/DEMISTING OFF"
- radio: "TUNE NAME"
- external device (USB): "TRACK"
- external device (iPod): "TRACK"
- SD card: "TRACK".

Start communicating with the system

Before you can start talking to the system you first have to press the **VOICE** or **MODE** button for each operation and wait until the system answers with a beep. See (page 252).

Press the button again to cancel the voice session.

Name tag

The name tag functionality can support the phone, audio and navigation features by using the "STORE NAME" function. You can assign name tags to items such as favourite radio stations and personal phone contacts. See **Audio unit commands** (page 253). See **Telephone commands** (page 264). See **Navigation system commands** (page 268).

- Store up to 20 name tags per function.
- The average recording time for each name tag is approximately 2-3 seconds.

AUDIO UNIT COMMANDS

CD Player

You can control playback directly by voice control.

Overview

The overview below shows the available voice commands. The following lists will give further information about the complete command menu in selected examples.

| |
|--------------------|
| "CD PLAYER" |
| "HELP" |
| "PLAY" |
| "TRACK"* |
| "SHUFFLE ALL" |
| "SHUFFLE FOLDER"** |
| "SHUFFLE OFF" |
| "REPEAT FOLDER"** |

Voice control

| |
|--------------------|
| "CD PLAYER" |
| "REPEAT TRACK" |
| "REPEAT OFF" |

* Can be used as a shortcut.

** Only available if the CD contains audio data files like MP3 or WMA.

Track

You can choose a track on your CD directly.

| Steps | User says | System answer |
|-------|---------------------------------|-----------------------|
| 1 | "CD PLAYER" | "CD PLAYER" |
| 2 | "TRACK"* | "TRACK NUMBER PLEASE" |
| 3 | "<a number between 1 and 99>"** | "TRACK <number>" |

* Can be used as a shortcut.

** Additionally, numbers can be spoken as up to four single digits (for example "2", "4", "5" for track 245)

Shuffle all

To set random playback.

| Steps | User says | System answer |
|-------|---------------|---------------|
| 1 | "CD PLAYER" | "CD PLAYER" |
| 2 | "SHUFFLE ALL" | |

CD Changer

Overview

The overview below shows the available voice commands. The following lists will give further information about the complete command menu in selected examples.

Voice control

| |
|---------------------|
| "CD CHANGER" |
| "HELP" |
| "PLAY" |
| "DISC"* |
| "TRACK"* |
| "SHUFFLE ALL" |
| "SHUFFLE CD" |
| "SHUFFLE FOLDER"** |
| "SHUFFLE OFF" |
| "REPEAT CD" |
| "REPEAT FOLDER"** |
| "REPEAT TRACK" |
| "REPEAT OFF" |

* Can be used as a shortcut.

** Only available if the CD contains audio data files like MP3 or WMA.

Disc

If you have a CD changer you can choose the disc number.

| Steps | User says | System answer |
|-------|------------------------------|----------------------|
| 1 | "CD CHANGER" | "CD CHANGER" |
| 2 | "DISC"* | "DISC NUMBER PLEASE" |
| 3 | "<a number between 1 and 6>" | "DISC <number>" |

* Can be used as a shortcut.

Track

You can choose a track on your CD directly.

Voice control

| Steps | User says | System answer |
|-------|---------------------------------|-----------------------|
| 1 | "CD CHANGER" | "CD CHANGER" |
| 2 | "TRACK"* | "TRACK NUMBER PLEASE" |
| 3 | "<a number between 1 and 99>"** | "TRACK <number>" |

* Can be used as a shortcut.

** Additionally, numbers can be spoken as up to four single digits (for example "2", "4", "5" for track 245)

Shuffle CD

To set random playback within the CD contents.

| Steps | User says | System answer |
|-------|--------------|---------------|
| 1 | "CD CHANGER" | "CD CHANGER" |
| 2 | "SHUFFLE CD" | |

Radio

The radio voice commands support the functionality of the radio and allow you to tune radio stations by voice control.

Overview

The overview below shows the available voice commands. The following lists will give further information about the complete command menu.

| |
|--------------------|
| "RADIO" |
| "HELP" |
| "AM" |
| "FM" |
| "TUNE NAME"* |
| "DELETE NAME" |
| "DELETE DIRECTORY" |
| "PLAY DIRECTORY" |
| "STORE NAME" |

Voice control

| |
|----------------|
| "RADIO" |
| "PLAY" |

* Can be used as a shortcut.

Tune frequency

This function allows you to tune your radio by voice commands.

| Steps | User says | System answer |
|-------|----------------|-----------------------|
| 1 | "RADIO" | "RADIO" |
| 2 | "AM" | "AM FREQUENCY PLEASE" |
| | "FM" | "FM FREQUENCY PLEASE" |
| 3 | "<frequency>"* | "TUNE <frequency>" |

* The frequency may be entered in a variety of ways. Refer below for representative examples.

FM band: 87.5 - 108.0 in increments of 0.1

- "Eighty nine point nine" (89.9)
- "Ninety" (90.0)
- "One hundred point five" (100.5)
- "One zero one point one" (101.1)
- "One zero eight" (108.0)

- "Five thirty one" (531)
- "Nine hundred" (900)
- "Fourteen forty" (1440)
- "Fifteen zero three" (1503)
- "Ten eighty" (1080)

Store name

If you have tuned a radio station, you can store it with a name in the directory.

AM/MW band: 531 - 1602 in increments of 9

AM/LW band: 153 - 281 in increments of 1

| Steps | User says | System answer |
|-------|--------------|-----------------------------------|
| 1 | "RADIO" | "RADIO" |
| 2 | "STORE NAME" | "STORE NAME" "NAME PLEASE" |
| 3 | "<name>" | "REPEAT NAME PLEASE" |
| 4 | "<name>" | "STORING NAME" "<name> STORED" |

Voice control

Tune name

This function allows you to call up a stored radio station.

| Steps | User says | System answer |
|-------|--------------|---------------|
| 1 | "RADIO" | "RADIO" |
| 2 | "TUNE NAME"* | "NAME PLEASE" |
| 3 | "<name>" | "TUNE <name>" |

* Can be used as a shortcut.

Delete name

This function allows you to delete a stored radio station.

| Steps | User says | System answer |
|-------|---------------|--|
| 1 | "RADIO" | "RADIO" |
| 2 | "DELETE NAME" | "NAME PLEASE" |
| 3 | "<name>" | "DELETE <name>" "CONFIRM YES OR NO" |
| 4 | "YES" | "DELETED" |
| | "NO" | "COMMAND CANCELLED" |

Play directory

This function allows you to let the system tell you all of the stored radio stations.

| Steps | User says | System answer |
|-------|------------------|--------------------|
| 1 | "RADIO" | "RADIO" |
| 2 | "PLAY DIRECTORY" | "PLAY <DIRECTORY>" |

Delete directory

This function allows you to delete all stored radio stations at once.

Voice control

| Steps | User says | System answer |
|-------|--------------------|---|
| 1 | "RADIO" | "RADIO" |
| 2 | "DELETE DIRECTORY" | "DELETE DIRECTORY" "CONFIRM YES OR NO" |
| 3 | "YES" | "RADIO DIRECTORY DELETED" |
| | "NO" | "COMMAND CANCELLED" |

Play

This function switches the audio source to the radio mode.

| Steps | User says | System answer |
|-------|-----------|---------------|
| 1 | "RADIO" | "RADIO" |
| 2 | "PLAY" | |

Auxiliary input

This function allows you to switch the audio source to the attached auxiliary input device.

| Steps | User says | System answer |
|-------|-------------------|-------------------|
| 1 | "EXTERNAL DEVICE" | "EXTERNAL DEVICE" |
| 2 | "LINE IN" | "LINE IN" |

External devices - USB

These voice commands support the functionality of an external USB device which may be connected to the audio unit.

Overview

The overview below shows the available voice commands. The following lists will give further information about the complete command menu in selected examples.

| |
|---------------------------------|
| "EXTERNAL DEVICE", "USB" |
| "HELP" |

Voice control

| |
|---------------------------------|
| "EXTERNAL DEVICE", "USB" |
| "PLAY" |
| "TRACK"* |
| "PLAYLIST"** |
| "FOLDER"** |
| "SHUFFLE ALL " |
| "SHUFFLE FOLDER" |
| "SHUFFLE PLAYLIST" |
| "SHUFFLE OFF" |
| "REPEAT TRACK" |
| "REPEAT FOLDER" |
| "REPEAT OFF" |

* Can be used as a shortcut.

** Playlists and folders activated by voice control must be assigned special filenames. See **General information** (page 271).

USB play

This function allows you to switch the audio source to the attached USB device.

| Steps | User says | System answer |
|-------|-------------------|-------------------|
| 1 | "EXTERNAL DEVICE" | "EXTERNAL DEVICE" |
| 2 | "USB" | "USB" |
| 3 | "PLAY" | |

USB Track

You can choose a track on your USB device directly.

Voice control

| Steps | User says | System answer |
|-------|--------------------------------|-----------------------|
| 1 | "EXTERNAL DEVICE" | "EXTERNAL DEVICE" |
| 2 | "USB" | "USB" |
| 3 | "TRACK" | "TRACK NUMBER PLEASE" |
| 4 | "<a number between 1 and 99>"* | "TRACK <number>" |

* Additionally, numbers can be spoken as up to four single digits (for example "2", "4", "5" for track 245)

External devices - iPod

These voice commands support the functionality of an iPod which may be connected to the audio unit.

Overview

The overview below shows the available voice commands. The following lists will give further information about the complete command menu in selected examples.

| "EXTERNAL DEVICE", "IPOD" |
|---------------------------|
| "HELP" |
| "PLAY" |
| "TRACK"* |
| "PLAYLIST"** |
| "SHUFFLE ALL" |
| "SHUFFLE PLAYLIST" |
| "SHUFFLE OFF" |
| "REPEAT TRACK" |
| "REPEAT OFF" |

* Can be used as a shortcut.

** Playlists activated by voice control must be assigned special filenames. See **General information** (page 271).

Voice control

iPod Track

You can choose a track off the all titles list of your iPod directly.

| Steps | User says | System answer |
|-------|---------------------------------|-----------------------|
| 1 | "EXTERNAL DEVICE" | "EXTERNAL DEVICE" |
| 2 | "IPOD" | "IPOD" |
| 3 | "TRACK"* | "TRACK NUMBER PLEASE" |
| 4 | "<a number between 1 and 99>"** | "TRACK <number>" |

* Can be used as a shortcut.

** Additionally, numbers can be spoken as up to five single digits (for example "5", "2", "4", "5", "3" for track 52453), to a limit of 65535.

iPod playlist

You can choose a playlist from your iPod directly.

| Steps | User says | System answer |
|-------|-------------------------------|--------------------------|
| 1 | "EXTERNAL DEVICE" | "EXTERNAL DEVICE" |
| 2 | "IPOD" | "IPOD" |
| 3 | "PLAYLIST"* | "PLAYLIST NUMBER PLEASE" |
| 4 | "<a number between 1 and 10>" | "PLAYLIST <number>" |

* Playlists activated by voice control must be assigned special filenames. See **General information** (page 271).

SD Card

These voice commands support the functionality of an SD card which has suitable audio files written to it.

Overview

The overview below shows the available voice commands. The following lists will give further information about the complete command menu in selected examples.

| |
|-----------|
| "SD CARD" |
| "HELP" |

Voice control

| |
|------------------|
| "SD CARD" |
| "PLAY" |
| "TRACK"* |
| "SHUFFLE ALL" |
| "SHUFFLE FOLDER" |
| "SHUFFLE OFF" |
| "REPEAT TRACK" |
| "REPEAT FOLDER" |
| "REPEAT OFF" |

* Can be used as a shortcut.

SD card play

This function allows you to switch the audio source to the SD card audio files.

| Steps | User says | System answer |
|-------|-----------|---------------|
| 1 | "SD CARD" | "SD CARD" |
| 2 | "PLAY" | |

SD card track

You can choose a track on your SD card directly.

| Steps | User says | System answer |
|-------|---------------------------------|-----------------------|
| 1 | "SD CARD" | "SD CARD" |
| 2 | "TRACK"* | "TRACK NUMBER PLEASE" |
| 3 | "<a number between 1 and 99>"** | "TRACK <number>" |

* Can be used as a shortcut.

** Additionally, numbers can be spoken as up to four single digits (for example "2", "4", "5" for track 245).

Voice control

TELEPHONE COMMANDS

Overview

Phone

Your phone system allows you to create an additional phonebook. The stored entries can be dialled by voice control. Phone numbers stored by using voice control are stored on the vehicle system and not in your phone.

The overview below shows the available voice commands. The following lists will give further information about the complete command menu in selected examples.

| |
|--------------------|
| "PHONE" |
| "HELP" |
| "MOBILE NAME"* |
| "DIAL NUMBER"* |
| "DIAL NAME"* |
| "DELETE NAME" |
| "DELETE DIRECTORY" |
| "PLAY DIRECTORY" |
| "STORE NAME" |
| "REDIAL"* |
| "ACCEPT CALLS" |
| "REJECT CALLS" |

* Can be used as a shortcut.

Create a phonebook

Store name

New entries can be stored with the "STORE NAME" command. This feature can be used to dial a number by calling up the name instead of the full phone number.

Voice control

| Steps | User says | System answer |
|-------|------------------|---|
| 1 | "PHONE" | "PHONE" |
| 2 | "STORE NAME" | "STORE NAME" "NAME PLEASE" |
| 3 | "<name>" | "REPEAT NAME PLEASE" |
| 4 | "<name>" | "STORING NAME" "<name> STORED" "NUMBER PLEASE" |
| 5 | "<phone number>" | "<phone number>" |
| 6 | "STORE" | "STORING NUMBER" "<phone number>" "NUMBER STORED" |

Delete name

Stored names can also be deleted from the directory.

| Steps | User says | System answer |
|-------|---------------|--|
| 1 | "PHONE" | "PHONE" |
| 2 | "DELETE NAME" | "NAME PLEASE" |
| 3 | "<name>" | "DELETE <name>" "CONFIRM YES OR NO" |
| 4 | "YES" | "<name> DELETED" |
| | "NO" | "COMMAND CANCELLED" |

Play directory

Use this function to let the system tell you all stored entries.

| Steps | User says | System answer |
|-------|------------------|------------------|
| 1 | "PHONE" | "PHONE" |
| 2 | "PLAY DIRECTORY" | "PLAY DIRECTORY" |

Voice control

Delete directory

This function allows you to delete all entries in one go.

| Steps | User says | System answer |
|-------|--------------------|---|
| 1 | "PHONE" | "PHONE" |
| 2 | "DELETE DIRECTORY" | "DELETE DIRECTORY" "CONFIRM YES OR NO" |
| 3 | "YES" | "DIRECTORY DELETED" |
| | "NO" | "COMMAND CANCELLED" |

Phone functions

Mobile name

This function allows you to access phone numbers stored with a name tag in your mobile phone.

| Steps | User says | System answer |
|-------|----------------|--|
| 1 | "PHONE" | "PHONE" |
| 2 | "MOBILE NAME"* | "MOBILE NAME" "<phone dependent dialogue>" |

* Can be used as a shortcut.

Dial number

Phone numbers can be dialled after giving the name tag voice command.

| Steps | User says | System answer |
|-------|------------------|--------------------------------|
| 1 | "PHONE" | "PHONE" |
| 2 | "DIAL NUMBER"* | "NUMBER PLEASE" |
| 3 | "<phone number>" | "<phone number> CONTINUE?" |
| 4 | "DIAL" | "DIALLING" |
| | "CORRECTION" | "<repeat last part of number>" |

Voice control

| Steps | User says | System answer |
|-------|-----------|---------------|
| | | CONTINUE?" |

* Can be used as a shortcut.

Dial name

Phone numbers can be dialled after giving the name tag voice command.

| Steps | User says | System answer |
|-------|--------------|--------------------------------------|
| 1 | "PHONE" | "PHONE" |
| 2 | "DIAL NAME"* | "NAME PLEASE" |
| 3 | "<name>" | "DIAL <name>" "CONFIRM YES OR NO" |
| 4 | "YES" | "DIALLING" |
| | "NO" | "COMMAND CANCELLED" |

* Can be used as a shortcut.

Redial

This function allows you to redial the last dialled phone number.

| Steps | User says | System answer |
|-------|-----------|---------------------------------|
| 1 | "PHONE" | "PHONE" |
| 2 | "REDIAL"* | "REDIAL" "CONFIRM YES OR NO" |
| 3 | "YES" | "DIALLING" |
| | "NO" | "COMMAND CANCELLED" |

* Can be used as a shortcut.

Voice control

DTMF (Tone dialling)

This function transfers spoken numbers into DTMF tones. For example, to make a remote enquiry to your home answering machine or to enter a PIN number etc.

Note: DTMF can only be used during an ongoing call. Press the VOICE button and wait for the system prompt.

Can only be used with vehicles installed with a dedicated VOICE button.

| Steps | User says | System answer |
|-------|--------------------------------------|-----------------|
| 1 | | "NUMBER PLEASE" |
| 2 | "<numbers 1 to 9, zero, hash, star>" | |

Main settings

Reject calls

Calls can be set to be automatically rejected using voice control.

| Steps | User says | System answer |
|-------|-----------------|----------------|
| 1 | "PHONE" | "PHONE" |
| 2 | "REJECT CALLS" | "REJECT CALLS" |
| | "ACCEPT CALLS"* | "ACCEPT CALLS" |

* use this command to turn the reject mode off

NAVIGATION SYSTEM COMMANDS

Please refer to your separate Navigation handbook for details of the command menus.

CLIMATE CONTROL COMMANDS

Climate

The climate voice commands supports the functionality of the fan speed, temperature and mode settings. Not all functions are available on all vehicles.

Overview

The overview below shows the available voice commands. The following lists will give further information about the complete command menu in selected examples.

Voice control

| |
|-----------------------------|
| "CLIMATE" |
| "HELP" |
| "FAN"* |
| "DEFROSTING/DEMISTING ON"* |
| "DEFROSTING/DEMISTING OFF"* |
| "TEMPERATURE"* |
| "AUTO MODE"* |

* Can be used as a shortcut. On vehicles fitted with an English language module the "FAN" shortcut is not available.

Fan

This function allows you to adjust the fan speed.

| Steps | User says | System answer |
|-------|------------------------------|--------------------|
| 1 | "CLIMATE" | "CLIMATE" |
| 2 | "FAN"* | "FAN SPEED PLEASE" |
| 3 | "MINIMUM" | "FAN MINIMUM" |
| | "<a number between 1 and 7>" | "FAN <number>" |
| | "MAXIMUM" | "FAN MAXIMUM" |

* Can be used as a shortcut. On vehicles fitted with an English language module the "FAN" shortcut is not available.

Voice control

Defrosting/Demisting

| Steps | User says | System answer |
|-------|---------------------------------|--------------------------------|
| 1 | "CLIMATE" | "CLIMATE" |
| 2 | "DEFROSTING ON/DEMISTING ON"* | "DEFROSTING ON/DEMISTING ON" |
| | "DEFROSTING OFF/DEMISTING OFF"* | "DEFROSTING OFF/DEMISTING OFF" |

* Can be used as a shortcut.

Temperature

This function allows you to adjust the temperature.

| Steps | User says | System answer |
|-------|--|------------------------|
| 1 | "CLIMATE" | "CLIMATE" |
| 2 | "TEMPERATURE"* | "TEMPERATURE PLEASE" |
| 3 | "MINIMUM" | "TEMPERATURE MINIMUM" |
| | "<a number between 15 and 29 °C with 0.5 increments>" or "<a number between 59 and 84 °F>" | "TEMPERATURE <number>" |
| | "MAXIMUM" | "TEMPERATURE MAXIMUM" |

* Can be used as a shortcut.

Auto mode

| Steps | User says | System answer |
|-------|--------------|---------------|
| 1 | "CLIMATE" | "CLIMATE" |
| 2 | "AUTO MODE"* | "AUTO MODE" |

* Can be used as a shortcut. Can be deactivated by selecting a different temperature or fan speed.

Connectivity

GENERAL INFORMATION

CAUTIONS

 Take care when handling external devices with exposed electrical connectors (such as the USB plug). Always replace the protective cap/shield when possible. There may be a risk of electrostatic discharge causing damage to the device.

 Do not touch or handle the USB socket in the vehicle. Cover the socket when not in use.

 Only use USB Mass-Storage device compliant devices.

 Always switch your audio unit to a different source (for example the radio) before unplugging the USB device.

 Do not install or connect USB hubs or splitters.

Note: *The system is only designed to recognize and read suitable audio files from a USB device that conforms to the USB Mass-Storage device class or an iPod. Not all available USB devices can be guaranteed to function with the system.*

Note: *It is possible to connect compatible devices with a trailing USB lead as well as those that plug into the vehicle USB socket directly (for example USB memory sticks and pen drives).*

Note: *Some USB devices with a higher power consumption may not be compatible (for example some larger hard drives).*

Note: *Access time to read the files on the external device will vary depending upon factors such as the file structure, size and device content.*

The system supports a range of external devices, to fully integrate with your audio unit via the USB and auxiliary input sockets. Once connected, control of the external device is possible via the audio unit.

A list of typical compatible devices are shown below:

- USB memory sticks
- USB portable hard drives
- MP3 players with USB connection
- iPod media players (refer to **www.ford-mobile-connectivity.com** for latest compatibility list).

The system is USB 2.0 full speed compatible, USB 1.1 host compliant and supports FAT 16/32 file systems.

Information on audio file structures for external devices

USB

Create only a single partition on the USB device.

If playlists are created, they must contain correct file paths referenced to the USB device. It is recommended to create the playlist after the audio files have been transferred to the USB device.

Playlists must be created in .m3u format.

Audio files must be in .mp3 format.

Do not exceed the following limits:

- 1000 items per folder (files, folders and playlists)
- 5000 folders per USB device (including playlists)
- 8 subfolder levels.

Connectivity

To enable voice control for custom playlists and folders, follow the procedure below:

- Create folders named with the structure "**Ford<*>**" where <*> is a number 1-10. For example "**Ford3**" without an extension.
- Create playlists named with the structure "**Ford<*>.m3u**" where <*> is a number 1-10. For example "**Ford5.m3u**" without any space between "**Ford**" and the number.

Thereafter, custom folders and playlists will be selectable with voice control. See **Audio unit commands** (page 253).

Audio unit commands (page 253).

iPod

To enable voice control for custom playlists, create playlists named with the structure "**Ford<*>**" where <*> is a number 1-10. For example "**Ford7**" without any space between "**Ford**" and the number.

Thereafter, playlists will be selectable with voice control. See **Audio unit commands** (page 253).

CONNECTING AN EXTERNAL DEVICE

WARNING



Make sure the external device is securely mounted within the vehicle, and that trailing connections do not obstruct any of the driving controls.

External devices may be connected using the auxiliary input socket and the USB port. See **Auxiliary input (AUX IN) socket** (page 135). See **USB port** (page 136).

Connection

Plug in the device, and if necessary secure it to prevent movement within the vehicle.

Connecting an iPod

For optimum convenience and audio quality, we recommend that you purchase a dedicated single connection lead available from your dealer.

Alternatively, it is possible to connect your iPod using the standard iPod USB cable and a separate 3.5mm audio jack lead. If using this method preset the iPod volume to maximum and turn off any equalizer settings before making the connections:

- Connect the headphone output of the iPod to the AUX IN socket.
- Connect the USB cable from the iPod to the vehicle USB socket.

USING A USB DEVICE

Various icons are used to identify types of audio file, folders etc.



USB device is the active source



Folder



Playlist



Album



Artist



Filename

Connectivity



Track title



Information not available

Sony radio

Operation

Select the USB device as the audio source by repeatedly pressing the **CD/AUX** button until USB appears in the display. After first connecting the USB device, the first track within the first folder will start to play automatically. Subsequently, following audio source switching, the position of playback on the USB device is remembered.

To browse the device contents, press the up/down arrow key or the OK button once.

The display will show the track information, together with other important information described below:

- A vertical scroll bar on the right side of the display shows the current position of the folder view.
- ">" after an entry indicates a further level down is readable (for example a folder named after an album, with individual album tracks within that folder).
- "<" before the list indicates that a further level up is readable.
- Icons to the left of track/folder text indicate the type of file/folder. Refer to the list for an explanation of these icons.

To navigate the USB device contents, use the up/down arrow keys to scroll through lists, and the left/right keys to move up or down within the folder hierarchy. Once your desired track, playlist or folder is highlighted, press the OK button to select playback.

Note: *If you wish to jump to the top level of the USB device contents, press and hold the left arrow key.*

Audio control

Press the left and right arrow keys to skip backwards and forwards through tracks.

Press and hold the left/right arrow keys to enable fast rewind/fast forward through track content.

Press the up/down arrow key or the OK button to browse the device contents.

Press the MENU key to enter the USB menu. It is possible to enable shuffle and repeat functions here with respect to folders and playlists.

Press the SCAN button to scan the whole device, current folder or a playlist if it is in operation.

Press the **INFO** button to display the following:

- filename
- title
- artist
- album
- track number and playing time.

Repeated button presses will scroll through these displays.

Connectivity

CD Navigation units

Operation

Select the USB device as the audio source by pressing the **CD/AUX** button until DEVICES appears in the display. Select DEVICES and then select USB from the available device list. After first connecting the USB device, the first track within the first folder will start to play automatically. Subsequently, following audio source switching, the position of playback on the USB device is remembered.

To browse the device contents, press the **SELECT** button once.

The display will show the track information, together with other important information described below:

- A vertical scroll bar on the right side of the display shows the current position of the folder view.
- ">" after an entry indicates a further level down is readable (for example a folder named after an album, with individual album tracks within that folder).
- "<" to the left hand side of the display indicates that a further level up is readable.
- Icons to the left of track/folder text indicate the type of file/folder. Refer to the list for an explanation of these icons.

To navigate the USB device contents, use the rotary scroll/select button to browse through lists. Push the button to expand the contents within the highlighted playlist or folder, or to commence playback of a particular track. Press **ESC** to go up one level.

Audio control

Press the **SEEK** up and down keys to skip backwards and forwards through tracks.

Press and hold the **SEEK** keys to enable fast rewind/fast forward through track content.

Rotate or press the **SELECT** button to browse the device contents.

Press SHUFFLE or REPEAT buttons to enable shuffle and repeat functions with respect to folders and playlists. Different options may appear depending upon whether or not a playlist is in operation.

Press the SCAN button to scan the current playlist if it is in operation, or the complete USB device or folder.

Press the **INFO** button to display the following:

- filename
- title
- artist
- album
- track number and playing time.

DVD Navigation units

Operation

Select the USB device as the audio source by pressing the **CD/AUX** button until the USB button appears to the left of the display. Select USB from the available device list.

Note: *Some devices may be shown but not selectable, depending if the device is connected or not.*

After first connecting the USB device, the first track within the first folder will start to play automatically. Subsequently, following audio source switching, the position of playback on the USB device is remembered.

Connectivity

To browse the device contents, press the scroll up or down arrow button.

The display will show the track information, together with other important information described below:

- A vertical scroll bar on the right side of the display shows the current position of the folder view.
- ">" after an entry indicates a further level down is readable (for example a folder named after an album, with individual album tracks within that folder).
- "<" to the left hand side of the display indicates that a further level up is readable.
- Icons to the left of track/folder text indicate the type of file/folder. Refer to the list for an explanation of these icons.

To navigate the USB device contents, use the scroll buttons to browse through lists. Push the button to expand the contents within the highlighted playlist or folder, or to commence playback of a particular track. Press the left arrow key to go up one level.

Audio control

Press the **SEEK** up and down keys to skip backwards and forwards through tracks.

Press and hold the **SEEK** keys to enable fast rewind/fast forward through track content.

Press the scroll bar arrow keys to browse the device contents.

Press SHUFFLE or REPEAT buttons to enable shuffle and repeat functions with respect to folders and playlists.

Press the SCAN button to scan the current playlist if it is in operation, or the complete USB device or folder.

Press the **INFO** button to display the following:

- filename
- title
- artist
- album
- track number and playing time.

USING AN IPOD

Various icons are used to identify types of audio file, folders etc.



iPod is the active source



iPod playlist



iPod artist



iPod album



iPod genre



iPod song



iPod generic category



iPod generic media file

Sony radio

Operation

Select the iPod as the audio source by repeatedly pressing the **CD/AUX** button until iPod appears in the display.

Connectivity

The iPod menu list for browsing contents will be available through the radio display. Navigation of the contents follows the same principles as for iPod standalone use (for example search by artist, title, etc.). To browse the iPod contents, press the up/down arrow key or the OK button once.

The display will show the track information, together with other important information described below:

- A vertical scroll bar on the right side of the display shows the current position of the list view.
- ">" after an entry indicates a further level down is readable (for example all albums by a particular artist).
- "<" before the list indicates that a further level up is readable.
- An icon on the left side indicates the type of the currently displayed list (for example list of albums). Refer to the list for an explanation of these icons.

To navigate the iPod contents, use the up/down arrow keys to scroll through lists, and the left/right keys to move up or down within the hierarchy. Once your desired track, playlist, album, artist or genre is highlighted, press the OK button to select playback.

Note: *If you wish to jump to the top level of the iPod contents, press and hold the left arrow key.*

Audio control

Press the left and right arrow keys to skip backwards and forwards through tracks.

Press and hold the left/right arrow keys to enable fast rewind/fast forward through track content.

Press the up/down arrow key or the OK button to browse the iPod contents.

Press the **MENU** key to enter the iPod menu. It is possible to enable shuffle and repeat functions here. It is also possible to enable the iPod "Shuffle songs" option directly from the top level.

Press the **SCAN** button to scan the currently selected tracks.

Press the **INFO** button to display the following:

- title
- artist
- track number and playing time.

Repeated button presses will scroll through these displays.

CD Navigation units

Operation

Select the iPod as the audio source by pressing the **CD/AUX** button until DEVICES appears in the display. Select DEVICES and then select iPod from the available device list.

The iPod menu list for browsing contents will be available through the display. Navigation of the contents follows the same principles as for iPod standalone use (for example search by artist, title, etc.). To browse the iPod contents, press the **SELECT** button once.

The display will show the track information, together with other important information described below:

- A vertical scroll bar on the right side of the display shows the current position of the list view.
- ">" after an entry indicates a further level down is readable (for example all albums by a particular artist).

Connectivity

- "<" before the list indicates that a further level up is readable.
- An icon on the left side indicates the type of the currently displayed list (for example list of albums). Refer to the list for an explanation of these icons.

To navigate the iPod contents, use the rotary scroll/select button to browse through lists. Push the button to expand the contents within the highlighted playlist, album, artist, genre or to commence playback of a particular track. Press **ESC** to go up one level.

Audio control

Press the **SEEK** up and down keys to skip backwards and forwards through tracks.

Press and hold the **SEEK** keys to enable fast rewind/fast forward through track content.

Rotate or press the **SELECT** button to browse the iPod contents.

Press the **MENU** key to enter the iPod menu. It is possible to enable shuffle and repeat functions here. It is also possible to enable the iPod "Shuffle songs" option directly from the top level.

Press the **SCAN** button to scan the currently selected tracks.

Press the **INFO** button to display the following:

- title
- artist
- track number and playing time.

DVD Navigation units

Operation

Select the iPod as the audio source by pressing the **CD/AUX** button until the iPod button appears to the left of the display. Select iPod from the available device list.

Note: *Some devices may be shown but not selectable, depending if the device is connected or not.*

The iPod menu list for browsing contents will be available through the display. Navigation of the contents follows the same principles as for iPod standalone use (for example search by artist, title, etc.). To browse the iPod contents, press the scroll up or down arrow button.

The display will show the track information, together with other important information described below:

- A vertical scroll bar on the right side of the display shows the current position of the list view.
- ">" after an entry indicates a further level down is readable (for example all albums by a particular artist).
- "<" before the list indicates that a further level up is readable.
- An icon on the left side indicates the type of the currently displayed list (for example list of albums). Refer to the list for an explanation of these icons.

To navigate the iPod contents, use the scroll buttons to browse through lists. Push the button to expand the contents within the highlighted playlist, album, artist, genre or to commence playback of a particular track. Press the left arrow key to go up one level.

Connectivity

Audio control

Press the **SEEK** up and down keys to skip backwards and forwards through tracks.

Press and hold the **SEEK** keys to enable fast rewind/fast forward through track content.

Press the scroll bar arrow keys to browse the iPod contents.

Press the MENU key to enter the iPod menu. It is possible to enable shuffle and repeat functions here. It is also possible to enable the iPod "Shuffle songs" option directly from the top level.

Press the SCAN button to scan the currently selected tracks.

Press the **INFO** button to display the following:

- title
- artist
- track number and playing time.

ROAD SAFETY

WARNINGS



The system provides you with information designed to help you reach your destination quickly and safely.



For reasons of safety, the driver should only program the system when the vehicle is stationary.



The system provides no assistance with respect to stop signs, traffic lights, areas under construction or other important safety information.



Do not use the system until you have familiarised yourself with its operation.



Only view the system display when driving conditions permit.

Safety information

Read and follow all stated safety precautions. Failure to do so may increase your risk of collision and personal injury. Ford Motor Company shall not be liable for any damages of any type arising from failure to follow these guidelines.

If detailed viewing of route instructions is necessary, pull off the road when it is safe to do so and park your vehicle.

Do not use the navigation system to locate emergency services.

To use the system as effectively and safely as possible, always use the latest navigation information. Your dealer will be able to assist with this.

Navigation system

GETTING STARTED

CAUTION

 Using the system with the engine off will drain the battery.

Note: You will be charged when sending and receiving text messages.

Note: Refer to your phone handbook for all phone functions and operation.

Note: Keep the activation code (printed on the installation guide) in a safe place.

Note: Retain the activation text message in your mobile phone inbox.

Compatibility of phones

CAUTION

 As no common agreement exists, mobile phone manufacturers are able to implement a variety of profiles in their Bluetooth devices. Because of this, an incompatibility can occur between the phone and hands-free system, which in some cases may significantly degrade the system performance. To avoid this situation, only recommended phones should be used.

Please visit the website www.ford-mobile-connectivity.com for full details.

Installing the micro SD card

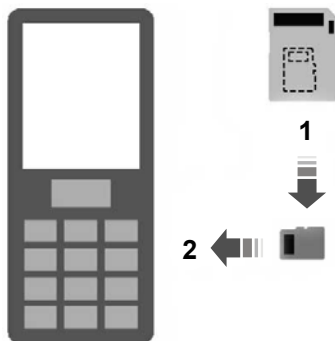

E114212

1. Remove the micro SD card from the adaptor.
2. Insert the micro SD card into the mobile phone.

Activating the mobile phone navigation system

Note: The radio must be switched on before connecting the mobile phone to the in-car GPS receiver.

Note: The Ford Mobile Navigation must be installed and activated on your mobile phone.

Note: It is possible to activate up to a **maximum** of three phones.

Note: Detailed instructions are available on the micro SD card and at www.ford-mobile-connectivity.com.

1. Switch the radio on.

Navigation system



E114213

2. Switch your mobile phone on and start the "Ford Mobile Navigation".
3. Choose "Select Destination".
4. Choose "Enter Address".
5. Change route options if necessary and start the route guidance.
6. The vehicle display will show the turn information. Voice instructions are heard via the vehicle speakers.

Note: *Your mobile phone will display your current position.*

7. You are able to exit the application and continue your route guidance after restarting the application.

Appendices





TYPE APPROVALS

Remote control

Note: We recommend that you use the remote control only in the countries listed.

If the type approval of your remote control is inspected, refer to the following table.

Remote control with flip key





| Type approval of the remote control | |
|---|--|
| Country | Official test number |
| (A) (AL) (AND) (B) (BIH) (CH) (CY) (D) (DK) (E) (F) (FIN) (GB) (GBZ) (GR) (H) (HR) (I) (IRL) (L) (M) (MK) (N) (NL) (P) (RO) (S) (SLO) (TR) (UA) (YU) | Siemens VDO, 5WK4 8791  ¹ |
| (BG) | Siemens VDO, 5WK4 8791,  |
| (CZ) | Siemens VDO, 5WK4 8791,  ¹ |
| (IL) | Siemens VDO, 5WK4 8791, 00590 2003 |
| (J) | Siemens VDO, 5WK4 8793 |
| (PL) | Siemens VDO, 5WK4 8791, CLBT/C/101/2003 |
| (RC) |  電波 92LP0323 |
| (SK) | Siemens VDO, 5WK4 8791,  ¹ |

¹ Hereby, Siemens VDO declares that this remote control is in compliance with the essential requirements and other relevant provisions of Directive 1999/5/EC.

E76938

Appendices

Remote control without flip key

| Type approval of the remote control | |
|---|---|
| Country | Official test number |
| (A) (B) (D) (DK) (E) (F) (FIN) (GB) (GR) (H) (I) (IRL) (IS) (L) (N) (NL) (P) (S) | CE 0499 0¹ |
| (AUS) (BR) (GBZ) (M) (TR) | SIEMENS 433,92 MHz 5WK4 725/8686/8071 |
| (CH) | BAKOM 97.0946.K.P. |
| (CY) | MCW 129/95 23/1997 |
| (CZ) |   |
| (IL) | 272/3-1998 |
| (NZ) |  |
| (PL) | 542/98 |
| (RC) |  電波 88LP0012 |
| (SK) |  TÚ R 119 SR 1999 2 |
| (ZA) | Ref.No.: 3K43D/3R1B9/SPLS-RX9/98 |

¹ Hereby, Siemens VDO declares that this remote control is in compliance with the essential requirements and other relevant provisions of Directive 1999/5/EC.

E76939

Appendices

Engine immobiliser



















If the type approval of your engine immobiliser is inspected, refer to the following table.

| Type approvals of the engine immobilisation system | |
|---|--------------------------------------|
| Country | Official test number |
| (A) (AND) (B) (CH) (D) (DK) (E) (F) (FIN) (FR) (GB) (GBZ) (GR) (H) (I) (IRL) (IS) (L) (LT) (N) (NL) (P) (RO) (S) (SLO) | CE 0682 0 ¹ |
| (AL) | 143 |
| (AUS) (BIH) (BM) (ET) (FP) (GAB) (J) (JA) (KN) (KWT) (MAC) (PNG) (RL) (TT) (WD) (WL) (WV) | No number required |
| (BDS) | 340/3 Vol. II |
| (BG) | ДКД П 14 085/2002 |
| (BRN) | DLM/GEN/18/18/16 |
| (BRU) | DRQ-D-PREMIER-10-1996-3860-LPD2-1667 |
| (BY) | BY/112 03.2.3. II A2294 |
| (CDN) | 3043104475A |

¹ Visteon Deutschland GmbH declares that the immobiliser system transceiver complies with the appropriate essential requirements of the Article 3 of the R&TTE and the other relevant provisions.

E76940

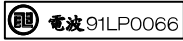
Appendices

| Type approvals of the engine immobilisation system | |
|---|---|
| Country | Official test number |
|  | M.C.W 129/95/(11) |
|  |  |
|  | SPLS/-485/2001 |
|  | <div style="border: 1px solid black; padding: 5px;"> <p style="font-size: small;">This product complies with the Telecommunication Law (Law Decree) (Regulation For Licensing Order) 此產品符合電訊(小功率零件) (豁免備牌) 令</p> <p style="font-size: x-small;">Certificate No.: LP402055 證書號碼:</p> <p style="font-size: x-small;">Office of the Telecommunications Authority 電訊管理局</p> </div> |
|  | SRD 153/01 |
|  | 4/U/U/4250 |
|  | (10/1900) |
|  | 451R |
|  | WT/122/98 II |
|  | F00053/1/2002 |
|  | RLVIVP03-324 |
|  | 08 114/2 |
|  | ENG 3/2/RFS29 |
|  | OMA/1265(A) 1308/2001 |
|  | M.L. S.H. Nr 003/2002 |
|  |  電波 91LP0066 |
|  | 1381 |
|  | 2003/348- OMERT/DC/CAA |

E76941

Appendices

| Type approvals of the engine immobilisation system | |
|--|--|
| Country | Official test number |
| (RP) | ESD- 0201430C |
| (RUS) |  ME83 POCC DE.ME83.B02099 |
| (SGP) | IDA approved part LPREQ-0259-2002 |
| (SK) | 171 |
| (TR) | B.61.TK.0.22.00.00/ 4940-2632 |
| (UAE) | 5/10-2/3274/3774 |
| (USA) (PR) | NT8-15607PAT3XCVR |
| (YU) | 11/1 01 009/2002 006 |
| (ZA) | SPLS/RX-485/2001 |

E76942

Alarm

If the type approval of your alarm is inspected, refer to the following official test numbers.

Appendices

e11 I-00 0012

E11 97R I-01 0012

e11 A-00 2236

E11 116R A-00 0084

E76974

TYPE APPROVALS

FCC/INDUSTRY CANADA NOTICE

This device complies with Part 15 of the FCC Rules. Operation is subject to the following two conditions: (1) this device may not cause harmful interference, and (2) this device must accept any interference received, including interference that may cause undesired operation.

FCC ID: WJLRX-42

IC: 7847A-RX42

Changes or modifications to your device not expressly approved by the party responsible for compliance can void the user's authority to operate the equipment.

RX-42 - declaration of conformity

We, the party responsible for compliance, declare under our sole responsibility that the Handset Integration product RX-42 is in conformity with the provisions of the following Council Directive: 1999/5/EC. A copy of the Declaration of Conformity can be found at:

www.novero.com/declaration_of_conformity

The Bluetooth word mark and logos are owned by the Bluetooth SIG, Inc. and any use of such marks by Ford Motor Company is under license. Other trademarks and trade names are those of their respective owners.

TYPE APPROVALS

iPod is a trademark of Apple Inc.

TYPE APPROVALS



© 2008 NAVTEQ B.V. All rights reserved.

Appendices

| | |
|------|--|
| (AT) | "© Bundesamt für Eich- und Vermessungswesen" |
| (PL) | "© EuroGeographics" |
| (FR) | "source: Géoroute® IGN France & BD Carto® IGN France" |
| (DE) | "Die Grundlagendaten wurden mit Genehmigung der zuständigen Behörden entnommen" |
| (GB) | "Based upon Crown Copyright material." |
| (GR) | "Copyright Geomatics Ltd." |
| (IT) | "La Banca Dati Italiana è stata prodotta usando quale riferimento anche cartografia numerica ed al tratto prodotta e fornita dalla Regione Toscana." |
| (NO) | "Copyright © 2000; Norwegian Mapping Authority" |
| (PT) | "Source: IgeoE – Portugal" |
| (ES) | "Información geográfica propiedad del CNIG" |
| (SE) | "Based upon electronic data © National Land Survey Sweden." |
| (CH) | "Topografische Grundlage: © Bundesamt für Landestopographie" |

ELECTROMAGNETIC COMPATIBILITY

WARNINGS

 Your vehicle has been tested and certified to European legislations relating to electromagnetic compatibility (2004/104/EC). It is your responsibility to ensure that any equipment you have fitted complies with applicable local legislations. Have any equipment fitted by properly trained technicians.

WARNINGS

 Radio frequency (RF) transmitter equipment (e.g. cellular telephones, amateur radio transmitters etc.) may only be fitted to your vehicle if they comply with the parameters shown in the table below. There are no special provisions or conditions for installations or use.

 Do not mount any transceiver, microphones, speakers, or any other item in the deployment path of the airbag system.

 Do not fasten antenna cables to original vehicle wiring, fuel pipes and brake pipes.

Appendices

WARNINGS



Keep antenna and power cables at least 100mm from any electronic

WARNINGS

modules and airbags.

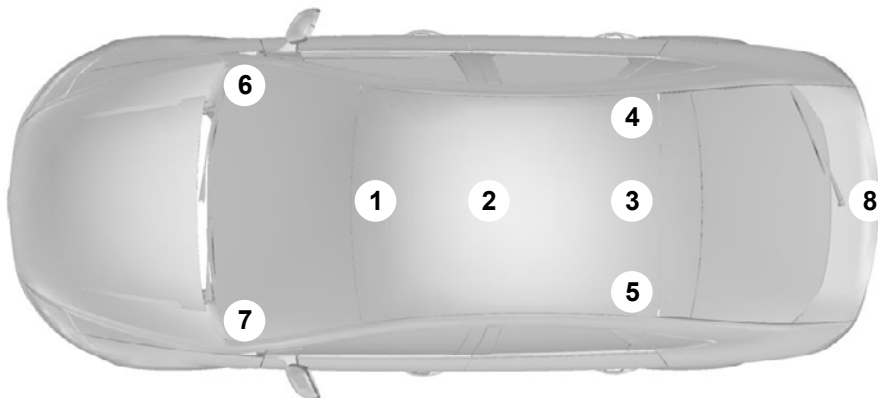

E85998

| Frequency Band MHz | Maximum output power Watt (Peak RMS) | Antenna Positions |
|--------------------|--------------------------------------|--|
| 1 – 30 | 50 W | 3, 8 |
| 30 – 54 | 50 W | 2, 3 |
| 68 – 87.5 | 50 W | 1, 2, 3, 4, 5 |
| 142 – 176 | 50 W | 1, 2, 3, 4, 5 |
| 380 – 512 | 50 W | 1, 2, 3, 4, 5 |
| 806 – 940 | 10 W (2 W ¹) | 1, 2, 3, 4, 5 (6 ¹ , 7 ¹) |
| 1200 – 1400 | 10 W | 2 |
| 1710 – 1885 | 10 W (1 W ¹) | 1, 2, 3, 4, 5 (6 ¹ , 7 ¹) |
| 1885 – 2025 | 10 W (1 W ¹) | 1, 2, 3, 4, 5 (6 ¹ , 7 ¹) |
| 2400 – 2500 | 0.1 W | All positions |

¹Only for GSM/3G cellular phones, with a patch antenna installed inside of the front windscreen.

Appendices

Note: *After the installation of RF transmitters, check for disturbances from and to all electrical equipment in the vehicle, both in the standby and transmit modes.*

Check all electrical equipment:

- with the ignition **ON**
- with the engine running
- during a road test at various speeds.

Check that electromagnetic fields generated inside the vehicle cabin by the transmitter installed do not exceed human exposure limits specified in EU directive 2004/40/EC.

Index

A

A/C

See: Climate control.....104

About this handbook.....7

ABS

See: Brakes.....149

ABS driving hints

See: Hints on driving with ABS.....149

ACC

See: Adaptive cruise control (ACC).....162

Accessories

See: Parts and accessories.....8

See: Using ACC.....163

Active suspension.....157

Principle of operation.....157

Active suspension

See: Using active suspension.....157

Adaptive cruise control (ACC).....162

Principle of operation.....162

Adaptive cruise control

See: Using ACC.....163

Adaptive front lighting system

(AFS).....55

Cornering lamps.....56

Adjusting the steering wheel.....45

AFS

See: Adaptive front lighting system

(AFS).....55

Air conditioning

See: Climate control.....104

Air vents.....104

Front air vents.....104

Second row air vents.....105

Third row air vents.....105

Alarm.....42

Principle of operation.....42

Appendices.....282

Arming the alarm.....44

All vehicles.....44

Arming the engine immobiliser.....41

Ashtray.....129

Front ashtray.....129

Rear ashtray.....129

Audible warnings and indicators.....81

Switching the chimes on and off.....81

Audio control.....45

Mode.....45

Seek.....46

Audio unit commands.....253

Auxiliary input.....259

CD Changer.....254

CD Player.....253

External devices - iPod.....261

External devices - USB.....259

Radio.....256

SD Card.....262

Auto-dimming mirror.....74

Autolamps.....53

Automatic climate control.....108

Air distribution.....110

Blower.....110

Mono mode.....109

Rear air conditioning (triple-zone automatic

climate control).....111

Recirculated air.....110

Setting the temperature.....109

Switching the air conditioning on and

off.....110

Switching the automatic climate control

on and off.....111

Windscreen defrosting and

demisting.....110

Automatic transmission.....146

Drive modes.....147

Emergency park position release

lever.....148

Hints on driving with an automatic

transmission.....147

Selector lever positions.....146

Autowipers.....47

Auxiliary heater.....113

Changing the remote control battery.....117

Diesel auxiliary heater (depending on

country).....115

Feedback during starting and switching

off.....116

Fuel operated heater (depending on

country).....115

Parking heater.....113

Programming the transmitter.....117

Remote start in combination with direct

start or timer.....116

Remote starting.....116

Index

| | |
|--------------------------------------|-----|
| Auxiliary input (AUX IN) socket..... | 135 |
| Auxiliary power sockets..... | 129 |
| Galaxy..... | 130 |
| S-Max..... | 130 |

B

| | |
|--|-----|
| Battery connection points..... | 223 |
| Bluetooth setup..... | 246 |
| Handling of phones..... | 246 |
| Requirements for Bluetooth connection..... | 246 |
| Bonnet lock | |
| See: Opening and closing the bonnet..... | 206 |
| Booster cables | |
| See: Using booster cables..... | 222 |
| Booster cushions..... | 21 |
| Booster cushion (Group 3)..... | 22 |
| Booster seat (Group 2)..... | 21 |
| Brake and clutch fluid check..... | 216 |
| Brakes..... | 149 |
| Principle of operation..... | 149 |
| Bulb changing | |
| See: Changing a bulb..... | 59 |
| Bulb specification chart..... | 69 |

C

| | |
|---|-----|
| Cargo nets..... | 173 |
| Luggage retention net - type 1..... | 173 |
| Luggage retention net - type 2..... | 175 |
| Car wash | |
| See: Cleaning the exterior..... | 220 |
| Catalytic converter..... | 142 |
| Driving with a catalytic converter..... | 142 |
| Parking..... | 142 |
| CD changer..... | 135 |

| | |
|---|-----|
| Changing a bulb..... | 59 |
| Approach lamp..... | 61 |
| Central high mounted brake lamp (Galaxy)..... | 67 |
| Central high mounted brake lamp (S-MAX)..... | 66 |
| Front fog lamp and side lamp (Galaxy)..... | 62 |
| Front fog lamp and side lamp (S-MAX)..... | 61 |
| Headlamp..... | 59 |
| Interior lamps..... | 67 |
| Luggage compartment lamp..... | 69 |
| Number plate lamp..... | 67 |
| Reading lamps..... | 68 |
| Rear lamp (Galaxy)..... | 64 |
| Rear lamp (S-MAX)..... | 63 |
| Side repeater..... | 60 |
| Vanity mirror lamp..... | 69 |
| Changing a fuse..... | 194 |
| Changing a road wheel..... | 224 |
| Installing a road wheel..... | 226 |
| Jacking and lifting points..... | 224 |
| Locking wheel nuts..... | 224 |
| Removing a road wheel..... | 225 |
| Vehicle jack..... | 224 |
| Changing the remote control battery..... | 33 |
| Remote control with a folding key blade..... | 33 |
| Remote control without a folding key blade..... | 34 |
| Changing the wiper blades..... | 49 |
| Rear window wiper blades..... | 50 |
| Windscreen wiper blades..... | 49 |
| Checking the wiper blades..... | 49 |
| Childminder mirror..... | 135 |
| Child safety..... | 20 |
| Child safety locks..... | 26 |
| Child seat positioning..... | 22 |
| Child seats..... | 20 |
| Child restraints for different mass groups..... | 20 |
| Cigar lighter..... | 129 |

Index

- Cleaning the exterior.....220
 Body paintwork preservation.....220
 Cleaning the chrome trim.....220
 Cleaning the headlamps.....220
 Cleaning the rear window.....220
Cleaning the interior.....220
 Instrument cluster screens, LCD screens,
 radio screens.....221
 Seat belts.....220
Climate control.....104
 Principle of operation.....104
Climate control commands.....268
 Climate.....268
Clock.....128
Coded keys.....41
Connecting an external device.....272
 Connection.....272
Connectivity.....271
 General information.....271
Convenience features.....128
Coolant check
 See: Engine coolant check.....215
Cruise control.....160
 Principle of operation.....160
Cruise control
 See: Using cruise control.....160
Cup holders.....130
 Seat back trays.....130
- D**
- Detachable tow ball.....183
 Driving with a trailer.....185
 Driving without a trailer.....186
 Inserting the tow ball arm.....184
 Maintenance.....186
 Removing the tow ball arm.....185
 Unlocking the tow ball arm
 mechanism.....184
Diesel particulate filter (DPF).....140
 Regeneration.....140
Direction indicators.....57
Disabling the passenger airbag.....31
 Disabling the passenger airbag.....32
 Enabling the passenger airbag.....32
 Fitting the passenger airbag deactivation
 switch.....32
- Disarming the alarm.....44
 Category one alarm.....44
 Perimeter alarm.....44
Disarming the engine immobiliser.....41
Dog guard.....180
 Installing the dog guard.....181
DPF
 See: Diesel particulate filter (DPF).....140
Driving hints.....190
Driving through water.....190
 Driving through water190
- E**
- Electric exterior mirrors.....73
 Electric folding mirrors.....73
 Mirror tilting positions.....73
 Reverse mirror clipping.....74
Electric parking brake (EPB).....150
 Applying the EPB.....150
 Applying the EPB when the vehicle is
 moving.....151
 Automatic application of the EPB.....150
 Cut in the power supply.....152
 Parking on a hill.....150
 Preventing automatic application of the
 EPB.....151
 Releasing the EPB.....151
Electric seats.....119
 2-way electric seat.....119
 8-way electric seat.....120
Electric windows.....71
 Anti-trap function.....72
 Driver's door switches.....71
 Front and rear passengers' door
 switches.....71
 Global opening and global closing.....71
 Opening and closing the windows
 automatically.....71
 Resetting the memory of the electric
 windows.....72
 Safety mode.....72
 Safety switch for rear windows.....71
Electromagnetic compatibility.....288
Emergency equipment.....191
Engine compartment overview - 1.8L
 Duratorq-TDCi (Lynx) Diesel.....211

Index

- Engine compartment overview - 2.0L
Duratec-HE (M14).....208
- Engine compartment overview - 2.0L
Duratorq-TDCi (DW) Diesel.....212
- Engine compartment overview - 2.2L
Duratorq-TDCi (DW) Diesel.....213
- Engine compartment overview - 2.3L
Duratec-HE (M14).....209
- Engine compartment overview - 2.5L
Duratec (M15).....210
- Engine coolant check.....215
- Checking the coolant level.....215
- Topping up.....215
- Engine heater.....140
- Engine immobiliser.....41
- Principle of operation.....41
- Engine oil check.....215
- Checking the oil level.....215
- Topping up.....215
- Engine oil dipstick - 1.8L Duratorq-TDCi
(Lynx) Diesel.....214
- Engine oil dipstick - 2.0L Duratec-HE
(M14)/2.3L Duratec-HE (M14).....214
- Engine oil dipstick - 2.0L Duratorq-TDCi
(DW) Diesel/2.2L Duratorq-TDCi (DW)
Diesel.....214
- Engine oil dipstick - 2.5L Duratec
(M15).....214
- EPB
See: Electric parking brake (EPB).....150
- Exterior mirrors.....73
- Manual folding mirrors.....73
- ## F
- Fastening the seat belts.....29
- Second row centre seat belt.....30
- First aid kit.....191
- Forward alert function.....166
- Adjusting the warning sensitivity.....167
- Switching forward alert on/off.....167
- Front fog lamps.....53
- Front seat armrest.....127
- Fuel and refuelling.....141
- Technical specifications.....143
- Fuel burning heater
See: Auxiliary heater.....113
- Fuel consumption.....143
- Fuel consumption
See: Technical specifications.....143
- Fuel filler flap.....142
- Fuel quality - Diesel.....141
- Fuel quality - E85.....141
- Long-term storage.....141
- Fuel quality - Petrol.....141
- Fuse box locations.....193
- Central fuse box.....193
- Engine compartment fuse box.....193
- Rear fuse box.....194
- Fuses.....193
- Fuse specification chart.....195
- Central fuse box.....198
- Engine compartment fuse box.....195
- Rear fuse box.....201
- ## G
- Gauges.....77
- Engine coolant temperature gauge.....78
- Fuel gauge.....79
- Gearbox
See: Transmission.....146
- General information on radio
frequencies.....33
- Getting started.....280
- Activating the mobile phone navigation
system.....280
- Compatibility of phones.....280
- Installing the micro SD card.....280
- Glasses holder.....134
- Global opening and closing.....39
- Global closing.....40
- Global opening.....39
- Glove box.....130
- Cooled glove box.....130
- ## H
- Handbrake
See: Parking brake.....149
- Hazard warning flashers.....55
- Headlamp levelling.....53
- Recommended headlamp levelling switch
positions.....54
- Headlamp washers.....49

Index

- Head restraints.....121
Adjusting the head restraint.....121
Removing the head restraint.....121
Heated seats.....126
Heated windows and mirrors.....112
Heated exterior mirrors.....113
Heated windows.....112
Heating
See: Climate control.....104
Hill launch assist (HLA).....154
Principle of operation.....154
Hill launch assist
See: Using HLA.....154
Hints on driving with ABS.....149
HLA
See: Hill launch assist (HLA).....154
See: Using HLA.....154
- I**
- Ignition switch.....137
Immobiliser
See: Engine immobiliser.....41
Information displays.....82
General information.....82
Information messages.....95
Active suspension.....96
Alarm.....96
Battery and charging system.....97
Climate control.....97
Cruise control and Adaptive cruise control
(ACC).....97
Doors open.....98
Electric parking brake (EPB).....100
Engine immobiliser.....98
Hill launch assist (HLA).....98
Lighting.....99
Maintenance.....99
Message indicator.....95
Message symbols.....95
Occupant protection.....100
Parking brake.....100
Power steering.....101
Stability control (ESP).....101
Transmission.....101
Tyre pressure monitoring system.....101
Viewing current messages.....95
Voice control.....103
- Inspecting safety system
components.....192
Seat belts.....192
Instrument lighting dimmer.....128
Instruments.....77
Interior lamps.....57
Courtesy lamp.....57
Reading lamps.....57
Vanity mirror lamps.....58
Introduction.....7
ISOFIX anchor points.....25
Attaching a child seat with top
tethers.....25
Top tether anchor points.....25
- J**
- Jump starting
See: Using booster cables.....222
- K**
- Keys and remote controls.....33
- L**
- Lighting control.....52
Headlamp flasher.....52
Home safe lighting.....53
Lighting control positions.....52
Main and dipped beam.....52
Parking lamps.....52
Lighting.....52
Load carriers
See: Roof racks and load carriers.....176
Load carrying.....168
General information.....168
Load retaining fixtures.....177
Installing the load bracket.....179
Installing the load retaining fixtures.....177
Installing the luggage anchor points.....179

Index

- Locking and unlocking.....37
Automatic relocking.....39
Central locking.....37
Double locking.....37
Double locking the doors with the key.....37
Locking and unlocking confirmation.....37
Locking and unlocking the doors and the luggage compartment lid with the remote control.....38
Locking and unlocking the doors from inside.....38
Locking and unlocking the doors with the key.....37
Luggage compartment lid.....39
Reprogramming the unlocking function.....39
Locks.....37
Luggage anchor points.....169
Galaxy.....169
S-MAX.....170
Luggage covers.....176
- ## M
- Maintenance.....206
General information.....206
Technical specifications.....217
Manual climate control.....105
Air conditioning.....106
Air distribution control.....105
Blower.....106
Heating the interior quickly.....106
Recirculated air.....106
Ventilation.....106
Manual seats.....118
Adjusting the angle of the seatback.....119
Adjusting the height of the driver's seat.....119
Adjusting the lumbar support.....119
Moving the seats backwards and forwards.....118
Manual transmission.....146
All vehicles.....146
Selecting reverse gear.....146
Map pockets.....133
- Memory function.....134
Recalling a stored seat position.....135
Setting a memory pre-set.....134
Message centre
See: Information displays.....82
Mirrors
See: Heated windows and mirrors.....112
See: Windows and mirrors.....71
- ## N
- Navigation introduction.....279
Navigation system commands.....268
Navigation system.....280
- ## O
- Occupant protection.....27
Principle of operation.....27
Oil check
See: Engine oil check.....215
Opening and closing the bonnet.....206
Closing the bonnet.....207
Opening the bonnet.....206
- ## P
- Parking aid.....158
Principle of operation.....158
Parking aid
See: Using the parking aid.....158
Parking brake.....149
Applying the parking brake.....149
Parking on a hill.....150
Releasing the parking brake.....150
Parts and accessories.....8
Look for the Ford logo on the following parts8
Now you can be sure that your Ford parts are Ford parts.....8
Personalised settings.....93
Help screen, radio, navigation and phone information.....93
Language.....94
Navigation information.....93
Units of measure.....94
Power steering fluid check.....216
Topping up.....216

Index

| | |
|---|----|
| Programming the remote control..... | 33 |
| Programming a new remote control..... | 33 |
| Reprogramming the unlocking function..... | 33 |

Q

| | |
|---|----|
| Quick start..... | 11 |
| Adjusting the steering wheel..... | 13 |
| Autolamps..... | 15 |
| Automatic climate control..... | 17 |
| Automatic transmission..... | 18 |
| Autowipers..... | 15 |
| Direction indicators..... | 15 |
| Electric folding mirrors..... | 14 |
| Electric parking brake (EPB) | 18 |
| Engine idle speed after starting..... | 14 |
| Information displays..... | 15 |
| Instrument panel overview - left-hand drive..... | 11 |
| Instrument panel overview - right-hand drive..... | 12 |
| Manual climate control..... | 16 |
| Manual transmission..... | 18 |
| Memory function..... | 16 |
| Rear seat air vents..... | 17 |
| Reverse mirror dipping..... | 14 |

R

| | |
|--|-----|
| Rear fog lamps..... | 53 |
| Rear quarter windows..... | 75 |
| Electric rear quarter windows..... | 75 |
| Manual rear quarter windows..... | 75 |
| Rear seats..... | 121 |
| Creating a level load floor..... | 125 |
| Second row seats..... | 121 |
| Third row seats..... | 123 |
| Rear under floor storage..... | 172 |
| S-MAX..... | 173 |
| Vehicles with a sliding loadspace floor..... | 172 |
| Rear window wiper and washers..... | 48 |
| Intermittent wipe..... | 48 |
| Reverse gear wipe..... | 48 |
| Washer..... | 48 |
| Refuelling - E85..... | 143 |
| Refuelling..... | 143 |

| | |
|---|-----|
| Remote control battery | |
| See: Changing the remote control battery..... | 33 |
| Remote control programming | |
| See: Programming the remote control..... | 33 |
| Removing a headlamp..... | 58 |
| Repairing minor paint damage..... | 221 |
| Retractable tow ball..... | 186 |
| Driving with a trailer..... | 189 |
| Maintenance..... | 189 |
| Swivelling the tow ball in..... | 187 |
| Swivelling the tow ball out..... | 188 |
| Road Safety..... | 279 |
| Safety information..... | 279 |
| Roof racks and load carriers..... | 176 |
| Roof rack..... | 176 |
| Run flat tyres..... | 232 |
| Principle of operation..... | 232 |
| Replacing run flat tyres..... | 232 |
| What to do if a run flat tyre has a puncture..... | 232 |
| Running-in..... | 190 |
| Brakes and clutch..... | 190 |
| Engine..... | 190 |
| Tyres..... | 190 |

S

| | |
|--|-----|
| Safety precautions..... | 141 |
| Seat back trays..... | 133 |
| Seat belt height adjustment..... | 30 |
| Seat belt reminder..... | 31 |
| Deactivating the seat belt reminder..... | 31 |
| Seats..... | 118 |
| Sitting in the correct position..... | 118 |
| Sliding loadspace floor..... | 171 |
| Storage compartment..... | 171 |
| Snow chains | |
| See: Using snow chains..... | 233 |
| Speed control | |
| See: Cruise control..... | 160 |
| Stability control..... | 153 |
| Principle of operation..... | 153 |
| Stability control | |
| See: Using stability control..... | 153 |
| Starter switch | |
| See: Ignition switch..... | 137 |

Index

| | |
|--|-----|
| Starting a diesel engine..... | 139 |
| Cold or hot engine..... | 139 |
| Starting a petrol engine - E85..... | 138 |
| Starting at low ambient temperatures | 139 |
| Starting a petrol engine..... | 137 |
| Cold or hot engine..... | 138 |
| Engine idle speed after starting..... | 138 |
| Flooded engine..... | 138 |
| Starting the engine..... | 137 |
| General information..... | 137 |
| Status after a collision..... | 192 |
| Steering wheel lock..... | 137 |
| Vehicles with keyless starting..... | 137 |
| Vehicles without keyless starting..... | 137 |
| Steering wheel..... | 45 |
| Storage compartments..... | 131 |
| Front storage compartments..... | 131 |
| Overhead storage compartments..... | 132 |
| Rear storage compartment..... | 132 |
| Under floor storage compartment..... | 133 |
| Under seat storage compartment..... | 132 |
| Sun blinds..... | 128 |
| Roof (Galaxy)..... | 128 |
| Roof (S-Max)..... | 128 |
| Side windows..... | 128 |
| Switching off the engine..... | 140 |
| Vehicles with a turbocharger..... | 140 |
| Symbols glossary..... | 7 |
| Symbols in this handbook..... | 7 |
| Symbols on your vehicle..... | 7 |
| T | |
| Technical specifications..... | 239 |
| Technical specifications..... | 239 |
| Telephone commands..... | 264 |
| Create a phonebook..... | 264 |
| Main settings..... | 268 |
| Phone..... | 264 |
| Phone functions..... | 266 |
| Telephone controls..... | 247 |
| Remote control..... | 247 |
| Telephone setup..... | 245 |
| Bond another Bluetooth phone..... | 246 |
| Making a phone an active phone..... | 246 |
| Phonebook..... | 245 |
| Phonebook categories..... | 245 |
| Telephone..... | 245 |
| General information..... | 245 |
| Telephone | |
| See: Using the telephone - Vehicles With: Navigation System..... | 250 |
| See: Using the telephone - Vehicles Without: Navigation System..... | 247 |
| Towing a trailer..... | 183 |
| Steep gradients..... | 183 |
| Towing points..... | 204 |
| Towing the vehicle on four wheels..... | 204 |
| All vehicles..... | 204 |
| Vehicles with automatic transmission..... | 205 |
| Towing..... | 183 |
| Transmission..... | 146 |
| Trip computer..... | 91 |
| Average fuel consumption..... | 91 |
| Average speed..... | 91 |
| Distance to empty..... | 91 |
| Odometer..... | 91 |
| Outside air temperature..... | 91 |
| Tripmeter..... | 91 |
| Type 1 and 2..... | 92 |
| Type 3..... | 92 |
| Type approvals..... | 282 |
| Alarm..... | 286 |
| Engine immobiliser..... | 284 |
| FCC/INDUSTRY CANADA NOTICE..... | 287 |
| Remote control..... | 282 |
| RX-42 - declaration of conformity..... | 287 |
| Tyre care..... | 233 |
| Tyre pressure monitoring system..... | 234 |
| Checking the tyre pressures..... | 234 |
| Setting the vehicle load..... | 234 |
| Tyre pressures | |
| See: Technical specifications..... | 235 |
| Tyre repair kit..... | 227 |
| Checking the tyre pressure..... | 231 |
| General information..... | 227 |
| Inflating the tyre..... | 228 |
| Using the tyre repair kit..... | 228 |
| Tyres | |
| See: Wheels and tyres..... | 224 |

Index

U

| | |
|---|-----|
| USB port..... | 136 |
| Using ACC..... | 163 |
| Automatic deactivation..... | 165 |
| Cancelling ACC..... | 165 |
| Changing the set speed..... | 164 |
| Resuming ACC..... | 165 |
| Setting a speed..... | 164 |
| Setting the vehicle gap..... | 164 |
| Switching ACC off..... | 165 |
| Switching ACC on..... | 164 |
| Using active suspension..... | 157 |
| Selecting a setting..... | 157 |
| System malfunction..... | 157 |
| Using an iPod..... | 275 |
| CD Navigation units..... | 276 |
| DVD Navigation units..... | 277 |
| Sony radio..... | 275 |
| Using a USB device..... | 272 |
| CD Navigation units..... | 274 |
| DVD Navigation units..... | 274 |
| Sony radio..... | 273 |
| Using booster cables..... | 222 |
| To connect the booster cables..... | 222 |
| To start the engine..... | 222 |
| Using cruise control..... | 160 |
| Cancelling the set speed..... | 160 |
| Changing the set speed..... | 160 |
| Resuming the set speed..... | 161 |
| Setting a speed..... | 160 |
| Switching cruise control off..... | 161 |
| Switching cruise control on..... | 160 |
| Using HLA..... | 154 |
| Activating the HLA..... | 155 |
| Deactivating the HLA..... | 156 |
| Using seat belts during pregnancy..... | 31 |
| Using snow chains..... | 233 |
| Using stability control..... | 153 |
| Using the parking aid..... | 158 |
| Manoeuvring with the parking aid..... | 158 |
| Switching the parking aid on and off..... | 158 |

| | |
|---|-----|
| Using the telephone - Vehicles With: | |
| Navigation System..... | 250 |
| Changing the active phone..... | 251 |
| Debonding a bonded phone..... | 251 |
| Making a call..... | 250 |
| Muting the microphone..... | 250 |
| Receiving an incoming call..... | 250 |
| Receiving a second incoming call..... | 250 |
| Using the telephone - Vehicles Without: | |
| Navigation System..... | 247 |
| Changing the active phone..... | 249 |
| Debonding a bonded phone..... | 249 |
| Debonding a bonded phone - Sony | |
| radio..... | 249 |
| Making a call..... | 247 |
| Muting the microphone..... | 249 |
| Receiving an incoming call..... | 248 |
| Receiving a second incoming call..... | 248 |
| Using voice control..... | 252 |
| Name tag..... | 253 |
| System operation..... | 252 |
| Using winter tyres..... | 233 |

V

| | |
|------------------------------------|-----|
| Vehicle battery..... | 222 |
| Vehicle care..... | 220 |
| Vehicle identification number | |
| (VIN)..... | 238 |
| Vehicle identification plate..... | 238 |
| Vehicle identification..... | 238 |
| Vehicle recovery..... | 204 |
| Ventilated seats..... | 126 |
| Ventilation | |
| See: Climate control..... | 104 |
| Vents | |
| See: Air vents..... | 104 |
| VIN | |
| See: Vehicle identification number | |
| (VIN)..... | 238 |
| Voice control..... | 252 |
| Principle of operation..... | 252 |

W

| | |
|---|-----|
| Warning lamps and indicators..... | 79 |
| ABS warning lamp..... | 79 |
| Airbag warning lamp..... | 79 |
| Brake system lamp..... | 79 |
| Cruise control indicator..... | 79 |
| Direction indicators..... | 79 |
| Electric parking brake (EPB) warning lamp..... | 80 |
| Engine warning lamp..... | 79 |
| Forward alert indicator..... | 80 |
| Front fog lamp indicator..... | 80 |
| Frost warning lamp..... | 80 |
| Glow plug indicator..... | 80 |
| Headlamp indicator..... | 80 |
| Ignition warning lamp..... | 80 |
| Low fuel level warning lamp..... | 80 |
| Main beam indicator..... | 80 |
| Maximum engine speed indicator..... | 80 |
| Message indicator..... | 80 |
| Oil pressure warning lamp..... | 80 |
| Rear fog lamp indicator..... | 81 |
| Seat belt reminder..... | 81 |
| Stability control (ESP) warning lamp..... | 81 |
| Warning triangle..... | 191 |
| Washer fluid check..... | 216 |
| Washers | |
| See: Wipers and washers..... | 47 |
| Washing | |
| See: Cleaning the exterior..... | 220 |
| Wheels and tyres..... | 224 |
| General information..... | 224 |
| Technical specifications..... | 235 |
| Windows and mirrors..... | 71 |
| Windscreen washers..... | 48 |
| Windscreen wipers..... | 47 |
| Intermittent wipe..... | 47 |
| Winter tyres | |
| See: Using winter tyres..... | 233 |
| Wipers and washers..... | 47 |
| Technical specifications..... | 51 |



Feel the difference

