

FORD **GALAXY** / **S-MAX** Owner's Manual



The information contained in this publication was correct at the time of going to print. In the interest of continuous development, we reserve the right to change specifications, design or equipment at any time without notice or obligation. No part of this publication may be reproduced, transmitted, stored in a retrieval system or translated into any language in any form by any means without our written permission. Errors and omissions excepted.

© Ford Motor Company 2013

All rights reserved.

Part Number: CG3533en 01/2013 20130201155245

Table of Contents

Introduction

About This Manual.....	7
Symbols Glossary.....	7
Replacement Parts Recommendation.....	8

At a Glance

At a Glance.....	9
------------------	---

Child Safety

Child Seats.....	21
Booster Seats.....	22
Child Seat Positioning.....	23
ISOFIX Anchor Points.....	26
Child Safety Locks.....	27

Occupant protection

Principle of Operation.....	28
Fastening the seat belts.....	30
Seat belt height adjustment.....	31
Seat belt reminder.....	31
Using seat belts during pregnancy.....	32
Disabling the passenger airbag.....	32

Keys and Remote Controls

General Information on Radio Frequencies.....	34
Programming the remote control.....	34
Changing the remote control battery.....	34

Locks

Locking and Unlocking.....	37
Global Opening and Closing.....	39
Keyless Entry.....	40

Engine immobiliser

Principle of Operation.....	44
Coded keys.....	44
Arming the engine immobiliser.....	44

Disarming the engine immobiliser.....	44
---------------------------------------	----

Alarm

Principle of Operation.....	45
Arming the alarm.....	47
Disarming the alarm.....	47

Steering Wheel

Adjusting the Steering Wheel.....	48
Audio Control.....	48

Wipers and Washers

Windscreen Wipers.....	50
Autowipers.....	50
Windscreen Washers.....	51
Adjusting the windscreen washer jets.....	51
Rear Window Wiper and Washers.....	51
Headlamp Washers.....	51
Checking the Wiper Blades.....	52
Changing the Wiper Blades.....	52
Technical Specifications.....	53

Lighting

General Information.....	54
Lighting Control.....	54
Daytime Running Lamps.....	55
Autolamps.....	55
Automatic Main Beam Control.....	55
Front Fog Lamps.....	57
Rear Fog Lamps.....	57
Adjusting the Headlamps - Vehicles With: Adaptive Front Lighting/Xenon Headlamps.....	57
Headlamp Levelling.....	58
Adaptive Headlamps.....	59
Hazard Warning Flashers.....	60
Direction Indicators.....	60
Interior Lamps.....	61
Removing a Headlamp.....	63

Table of Contents

Changing a Bulb.....	64
Bulb Specification Chart.....	72

Windows and Mirrors

Power Windows.....	74
Exterior Mirrors.....	76
Electric exterior mirrors.....	76
Auto-Dimming Mirror.....	78
Rear Quarter Windows.....	78
Blind Spot Monitor.....	79

Instrument Cluster

Gauges.....	82
Warning Lamps and Indicators.....	84
Audible Warnings and Indicators.....	87

Information Displays

General Information.....	88
Trip Computer.....	97
Personalised Settings.....	99
Information Messages.....	101

Climate Control

Principle of Operation.....	111
Air Vents.....	111
Manual Climate Control.....	112
Automatic Climate Control.....	115
Heated Windows and Mirrors.....	119
Auxiliary Heater.....	119

Seats

Sitting in the Correct Position.....	125
Manual Seats.....	125
Power Seats.....	126
Head Restraints.....	128
Rear Seats.....	128
Heated Seats.....	132
Ventilated Seats.....	133
Front Seat Armrest.....	134

Convenience features

Sun Shades.....	135
Instrument Lighting Dimmer.....	136
Clock.....	136
Cigar Lighter.....	137
Ashtray.....	137
Auxiliary Power Points.....	137
Cup Holders.....	138
Glove Box.....	138
Storage compartments.....	139
Map Pockets.....	140
Seat Back Trays.....	140
Glasses Holder.....	141
Memory Function.....	141
Childminder Mirror.....	142
CD changer.....	142
Auxiliary Input Socket.....	142
USB Port.....	143

Starting and Stopping the Engine

General Information.....	144
Ignition Switch.....	144
Keyless Starting.....	144
Steering Wheel Lock.....	146
Starting a Petrol Engine.....	147
Starting a Petrol Engine - E85.....	148
Starting a Diesel Engine.....	148
Diesel Particulate Filter.....	149
Switching Off the Engine.....	149
Engine Block Heater.....	149

Start-Stop

Principle of Operation.....	151
Using start-stop.....	151

Eco Mode

Principle of Operation.....	153
Using Eco mode.....	153

Table of Contents

Fuel and Refuelling

Safety Precautions.....	154
Fuel Quality - Petrol.....	154
Fuel Quality - E85.....	154
Fuel Quality - Diesel.....	154
Catalytic Converter.....	155
Fuel filler flap.....	155
Refuelling.....	157
Refuelling - E85.....	157
Fuel Consumption.....	157
Technical Specifications.....	157

Transmission

Manual Transmission.....	162
Automatic Transmission.....	162

Brakes

Principle of Operation.....	165
Hints on Driving With Anti-Lock Brakes.....	165
Parking Brake.....	165
Electric Parking Brake.....	166

Stability Control

Principle of Operation.....	169
Using Stability Control.....	169

Hill Start Assist

Principle of Operation.....	170
Using hill start assist.....	170

Active suspension

Principle of Operation.....	173
Using active suspension.....	173

Parking Aids

Principle of Operation.....	174
Parking Aid.....	174

Rear view camera

Principle of Operation.....	176
Rear View Camera.....	176

Cruise Control

Principle of Operation.....	179
Using Cruise Control.....	179

Adaptive cruise control (ACC)

Principle of Operation.....	181
Using Adaptive Cruise Control.....	182
Forward alert function.....	186

Speed Limiter

Principle of Operation.....	187
Using the speed limiter.....	187

Driver Alert

Principle of Operation.....	189
Using driver alert.....	189

Lane Departure Warning

Principle of Operation.....	191
Using lane departure warning.....	191

Load Carrying

General Information.....	193
Luggage Anchor Points.....	194
Sliding Loadspace Floor.....	196
Rear Under Floor Storage.....	197
Cargo Nets.....	198
Luggage Covers.....	201
Roof Racks and Load Carriers.....	201
Load Retaining Fixtures.....	203
Dog Guard.....	207

Towing

Towing a Trailer.....	210
-----------------------	-----

Table of Contents

Tow Ball.....	210	Engine Oil Dipstick - 2.0L Duratec-HE (M14)/2.3L Duratec-HE (M14).....	243
Retractable tow ball.....	213	Engine Oil Dipstick - 2.0L EcoBoost SCTi (M14).....	243
Driving Hints		Engine Oil Dipstick - 1.6L Duratorq-TDCi (DV) Diesel/2.0L Duratorq-TDCi (DW) Diesel/2.2L Duratorq-TDCi (DW) Diesel.....	243
Running-In.....	217	Engine Oil Check.....	244
Cold Weather Precautions.....	217	Engine Coolant Check.....	244
Driving Through Water.....	217	Brake and Clutch Fluid Check.....	245
Floor Mats.....	217	Power Steering Fluid Check.....	245
Roadside Emergencies		Washer Fluid Check.....	246
First Aid Kit.....	219	Technical Specifications.....	246
Warning Triangle.....	219		
Fuses		Vehicle Care	
Fuse Box Locations.....	220	Cleaning the Exterior.....	249
Changing a Fuse.....	221	Cleaning the Interior.....	250
Fuse Specification Chart.....	222	Repairing Minor Paint Damage.....	250
Vehicle recovery		Vehicle battery	
Towing Points.....	231	Jump-Starting the Vehicle.....	251
Towing the Vehicle on Four Wheels.....	231	Changing the 12V Battery.....	252
Maintenance		Battery connection points.....	252
General Information.....	233	Wheels and Tyres	
Opening and Closing the Bonnet.....	233	General Information.....	253
Under Bonnet Overview - 1.6L EcoBoost SCTi (Sigma).....	235	Changing a Road Wheel.....	253
Under Bonnet Overview - 2.0L Duratec-HE (M14).....	236	Temporary Mobility Kit.....	256
Under Bonnet Overview - 2.0L EcoBoost SCTi (M14).....	237	Tyre Care.....	260
Under Bonnet Overview - 2.3L Duratec-HE (M14).....	238	Using Winter Tyres.....	260
Under Bonnet Overview - 1.6L Duratorq-TDCi (DV) Diesel.....	239	Using Snow Chains.....	260
Under Bonnet Overview - 2.0L Duratorq-TDCi (DW) Diesel.....	240	Tyre Pressure Monitoring System.....	260
Under Bonnet Overview - 2.2L Duratorq-TDCi (DW) Diesel.....	242	Technical Specifications.....	262
Engine Oil Dipstick - 1.6L EcoBoost SCTi (Sigma).....	243	Vehicle identification	
		Vehicle Identification Plate.....	265
		Vehicle Identification Number.....	266

Table of Contents

Capacities and Specifications

Technical Specifications.....	267
-------------------------------	-----

Audio introduction

Important audio information.....	271
----------------------------------	-----

Audio unit overview

Audio unit overview.....	272
--------------------------	-----

Audio System Security

Security code.....	275
Lost security code.....	275
Entering a security code.....	275
Incorrect security code.....	275

Audio Unit Clock and Date Displays

Setting the clock and date on the audio unit.....	276
---	-----

Audio unit operation

On/off control.....	277
Bass/treble control.....	277
Balance/fade control.....	277
Audio menu control.....	277
Station preset buttons.....	279
Waveband button.....	279
Autostore control.....	279
Traffic information control.....	280
Station tuning control.....	281

Audio unit menus

Automatic volume control.....	283
Digital signal processing (DSP).....	283
Audio distortion reduction (CLIP).....	283
Alternative frequencies.....	284
Regional mode (REG).....	284
News broadcasts.....	285

Compact Disc Player

Loading compact discs.....	286
Track selection.....	286
Loading the compact disc changer.....	286
Unloading the compact disc changer.....	287
Compact disc playback.....	287
Fast forward/reverse.....	287
Shuffle/random.....	287
Compact disc track compression.....	288
Compact disc track scanning.....	288
Ejecting compact discs.....	288
Repeat compact disc tracks.....	289
MP3 file playback.....	289
MP3 display options.....	290
Ending compact disc playback.....	290

Auxiliary input (AUX IN) socket

Auxiliary input (AUX IN) socket.....	291
--------------------------------------	-----

Audio Troubleshooting

Audio troubleshooting.....	292
----------------------------	-----

Telephone

General Information.....	293
Bluetooth setup.....	293
Telephone setup.....	293
Telephone controls.....	294
Using the telephone - Vehicles Without: Navigation System.....	295
Using the telephone - Vehicles With: Navigation System.....	297

Voice control

Principle of Operation.....	300
Using voice control.....	300
Audio unit commands.....	301
Telephone commands.....	310
Navigation system commands.....	315

Table of Contents

Climate control commands.....315

Connectivity

General Information.....318

Connecting an external device.....319

Connecting an external device - Vehicles
With: Bluetooth.....319

Using a USB device.....320

Using an iPod.....322

Navigation introduction

Road Safety.....326

Navigation system

Getting started.....327

Appendices

Type approvals.....329

Type approvals.....329

Type approvals.....329

Type approvals.....330

Electromagnetic compatibility.....331

Introduction

ABOUT THIS MANUAL

Thank you for choosing Ford. We recommend that you take some time to get to know your vehicle by reading this manual. The more that you know about it, the greater the safety and pleasure you will get from driving it.

WARNING



Always drive with due care and attention when using and operating the controls and features on your vehicle.

Note: This manual describes product features and options available throughout the range, sometimes even before they are generally available. It may describe options not fitted to your vehicle.

Note: Some of the illustrations in this manual may be used for different models, so may appear different to your vehicle. However, the essential information in the illustrations is always correct.

Note: Always use and operate your vehicle in line with all applicable laws and regulations.

Note: Pass on this manual when selling your vehicle. It is an integral part of the vehicle.

This manual may qualify the location of a component as left-hand side or right-hand side. The side is determined when facing forward in the seat.

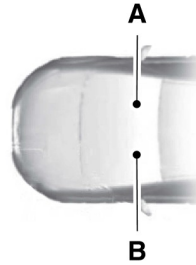

E154903

- A Right-hand side
- B Left-hand side

Protecting the Environment

You must play your part in protecting the environment. Correct vehicle usage and the authorised disposal of waste, cleaning and lubrication materials are significant steps toward this aim.

SYMBOLS GLOSSARY

Symbols in this handbook

WARNING



You risk death or serious injury to yourself and others if you do not follow the instructions highlighted by the warning symbol.

CAUTION



You risk damaging your vehicle if you do not follow the instructions highlighted by the caution symbol.

Symbols on your vehicle



Introduction



When you see these symbols, read and follow the relevant instructions in this handbook before touching or attempting adjustment of any kind.

REPLACEMENT PARTS RECOMMENDATION

Your vehicle has been built to the highest standards using quality parts. We recommend that you demand the use of genuine Ford and Motorcraft parts whenever your vehicle requires scheduled maintenance or repair. You can clearly identify genuine Ford and Motorcraft parts by looking for the Ford, FoMoCo or Motorcraft branding on the parts or their packaging.

Scheduled Maintenance and Mechanical Repairs

One of the best ways for you to make sure that your vehicle provides years of service is to have it maintained in line with our recommendations using parts that conform to the specifications detailed in this Owner's Manual. Genuine Ford and Motorcraft parts meet or exceed these specifications.

Collision Repairs

We hope that you never experience a collision, but accidents do happen. Genuine Ford replacement collision parts meet our stringent requirements for fit, finish, structural integrity, corrosion protection and dent resistance. During vehicle

development we validate these parts deliver the intended level of protection as a whole system. A great way to know for sure you are getting this level of protection is to use genuine Ford replacement collision parts.

Warranty on Replacement Parts

Genuine Ford and Motorcraft replacement parts are the only replacement parts that benefit from a Ford Warranty. Damage caused to your vehicle as a result of the failure of non-Ford parts may not be covered by the Ford Warranty. For additional information, refer to the terms and conditions of the Ford Warranty.

At a Glance

Instrument panel overview - left-hand drive



E74123

At a Glance

Instrument panel overview - right-hand drive

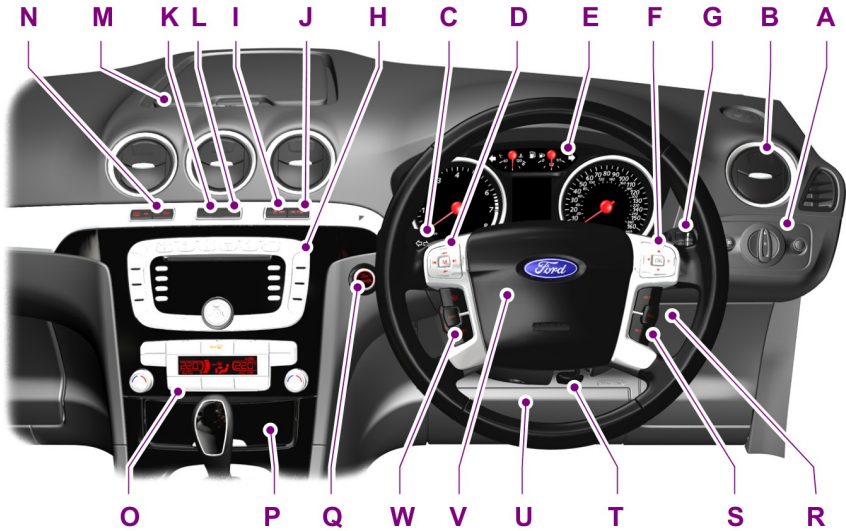

E75798

- A Lighting controls. See **Lighting Control** (page 54).
- B Air vents. See **Air Vents** (page 111).
- C Direction indicators. See **Direction Indicators** (page 60). Telephone control buttons. See **Telephone controls** (page 294). Voice control buttons. See **Using voice control** (page 300). Lane departure warning control buttons. See **Lane Departure Warning** (page 191).
- D Audio controls. See **Audio Control** (page 48).
- E Instrument cluster. See **Gauges** (page 82).
- F Information display controls. See **Information Displays** (page 88).
- G Wiper lever. See **Windscreen Wipers** (page 50).
- H Audio unit. See **Audio unit overview** (page 272).
- H Navigation unit. See separate handbook.
- I Start-stop switch. See **Using start-stop** (page 151).
- J Parking aid switch. See **Parking Aid** (page 174).
- K Hazard warning flasher switch. See **Hazard Warning Flashers** (page 60).

At a Glance

- L Passenger airbag deactivation warning lamp. See **Disabling the passenger airbag** (page 32).
- M Storage compartment. See **Storage compartments** (page 139).
- N Heated windscreen and heated rear window switches. See **Heated Windows and Mirrors** (page 119).
- O Climate controls. See **Manual Climate Control** (page 112). See **Automatic Climate Control** (page 115).
- P Cigar lighter. See **Cigar Lighter** (page 137).
- Q Start button. See **Keyless Starting** (page 144).
- R Ignition switch.
- S Cruise control and speed limiter switches. See **Using Cruise Control** (page 179). Adaptive cruise control (ACC) switches. See **Using Adaptive Cruise Control** (page 182). Speed limiter switches. See **Using the speed limiter** (page 187).
- T Steering wheel adjustment lever. See **Adjusting the Steering Wheel** (page 48).
- U Driver knee airbag. See **Principle of Operation** (page 28).
- V Horn.
- W Cruise control and speed limiter switches. See **Using Cruise Control** (page 179). Adaptive cruise control (ACC) switches. See **Using Adaptive Cruise Control** (page 182). Speed limiter switches. See **Using the speed limiter** (page 187).

At a Glance

Electric child safety locks



E124779

See **Child Safety Locks** (page 27).

Keyless entry

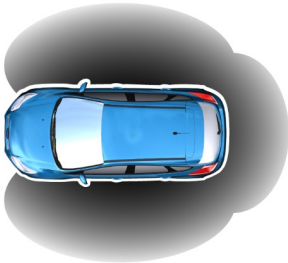

E78276

Passive locking and unlocking requires a valid passive key to be located within one of the three external detection ranges.

Unlocking the vehicle

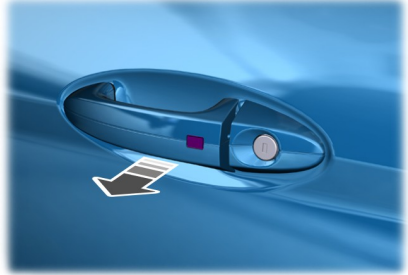

E78278

Pull a door handle to unlock all the doors and the luggage compartment lid and disarm the alarm.

Locking the vehicle

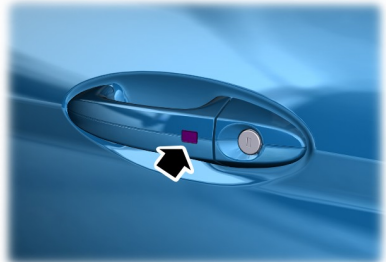

E87384



E87435

See **Keyless Entry** (page 40).

At a Glance

Adjusting the steering wheel

WARNING



Never adjust the steering wheel when the vehicle is moving.

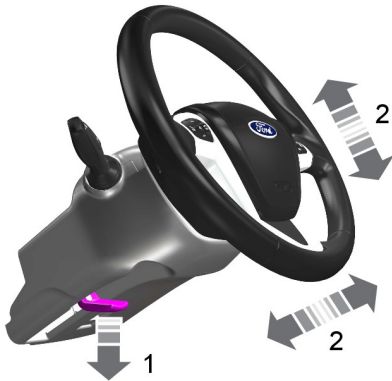

E95178



E95179

See **Adjusting the Steering Wheel** (page 48).

Autowipers

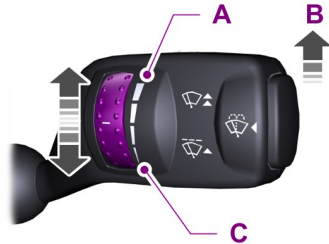

E70315

- A High sensitivity
- B On
- C Low sensitivity

Adjust the sensitivity of the rain sensor using the rotary control.

See **Autowipers** (page 50).

Changing the wiper blades

CAUTION



You can use the service position in winter to provide easier access to the wiper blades for freeing them from snow and ice. The windscreen wipers will return to their normal position as soon as you switch on the ignition so make sure that the outside of the windscreen is free from snow and ice before you switch on the ignition.

At a Glance

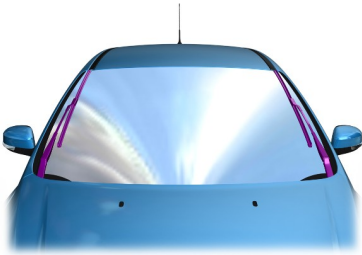

E75184



E75188

Switch off the ignition and move the wiper lever to position **A** within three seconds. Release the lever when the windscreen wipers have moved to the service position.

See **Changing the Wiper Blades** (page 52).

Autolamps



E70719

The headlamps will come on and go off automatically depending on the ambient light.

See **Lighting Control** (page 54).

Automatic main beam control

WARNING

 The system does not relieve you of your responsibility to drive with due care and attention. A manual override may be necessary if the system fails to switch the main beam on or off.

The system will automatically switch on main beam if it is dark enough and no other traffic is present. If it detects an approaching vehicle's headlamps or tail lamps, or street lighting ahead the system will switch off main beam before it can distract other road users. Dipped beams will remain on.

See **Automatic Main Beam Control** (page 55).

Direction indicators

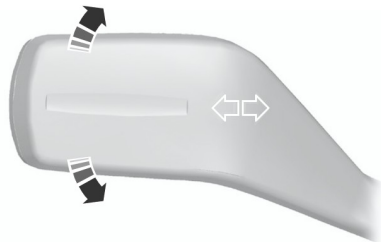

E70727

Note: Tap the lever up or down to make the direction indicators flash only three times.

Electric windows

Note: To reduce wind noise or buffeting when just one window is open, open the opposite window slightly.

See **Power Windows** (page 74).

At a Glance

Electric folding mirrors

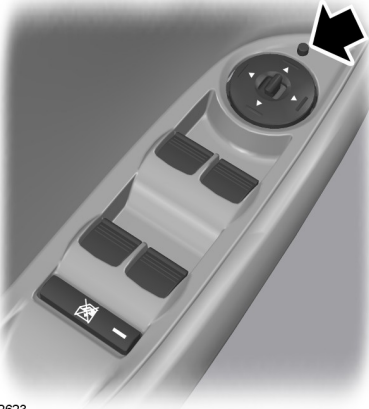

E72623

See **Electric exterior mirrors** (page 76).

Reverse mirror dipping

Depending on the selected mirror position, the relevant exterior mirror will dip whenever you select reverse gear, giving you a view of the kerb.

When you first use this feature, the mirrors will dip to a preset position. You can programme the degree of dipping.

See **Electric exterior mirrors** (page 76).

Blind spot information system (BLIS)

WARNING

 Do not use the system as a replacement for using the side and rear view mirrors, and looking over your shoulder before changing lanes. The system is not a replacement for careful driving and is only to be used as an aid.

The system displays a yellow indicator located in the exterior mirrors.



E124736

See **Blind Spot Monitor** (page 79).

Information displays



E70499

Use the arrow buttons to navigate through the menus and press **OK** to make a selection.

See **Information Displays** (page 88).

Manual climate control

Cooling the interior quickly

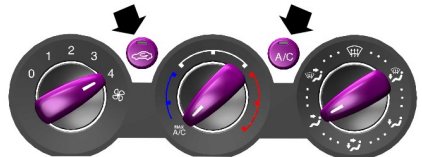

E71381

At a Glance

Heating the interior quickly

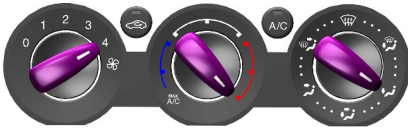

E71377

Recommended settings for cooling

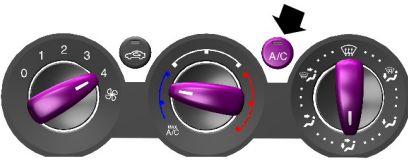

E131534

Open the centre and side air vents.
Direct the centre air vents upwards and the side air vents toward the side windows.

Recommended settings for heating

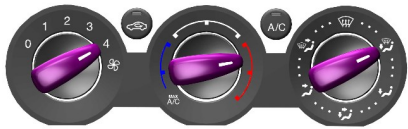

E131535

Close the centre air vents and open the side air vents.
Direct the side air vents toward the side windows.

Defrosting and demisting the windscreen

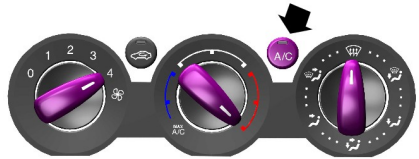

E71382

See **Manual Climate Control** (page 112).

Automatic climate control



E70304

See **Automatic Climate Control** (page 115).

Engine idle speed after starting

The engine may idle at a higher speed than normal immediately after starting from cold.

See **Starting and Stopping the Engine** (page 144).

Keyless starting



E85766

At a Glance

Press the start button.

Stopping the engine when the vehicle is moving

WARNING



Switching off the engine when the vehicle is still moving will result in a loss of brake and steering assistance. The steering will not be locked, but higher effort will be required. When the ignition is switched off some electrical circuits, warning lamps and indicators may also be OFF.

Press and hold the start button for two seconds, or press three times within three seconds.

See **Keyless Starting** (page 144).

Diesel particulate filter (DPF)

WARNING



Do not park or idle your vehicle over dry leaves, dry grass or other combustible materials. The DPF regeneration process creates very high exhaust gas temperatures and the exhaust will radiate a considerable amount of heat during and after DPF regeneration, and after you have switched the engine off. This is a potential fire hazard.

See **Diesel Particulate Filter** (page 149).

Fuel filler flap



E86613

Press the flap to open it. Open the flap fully until it engages.

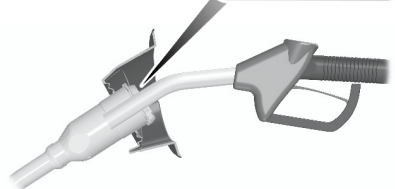
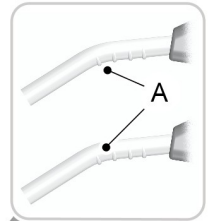

E139202

Insert the fuel nozzle up to and including the first notch on the nozzle **A**. Keep it resting on the cover of the fuel pipe opening.

WARNING



We recommend that you remove the fuel nozzle slowly to allow any residual fuel to drain into the fuel tank. Alternatively you can wait 10 seconds before removing the fuel nozzle.

At a Glance

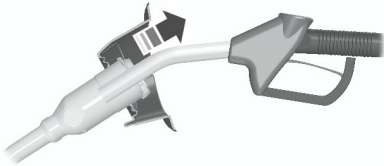

E119081

Slightly raise the fuel nozzle to remove it.

See **Fuel filler flap** (page 155).

Manual transmission

Selecting reverse gear

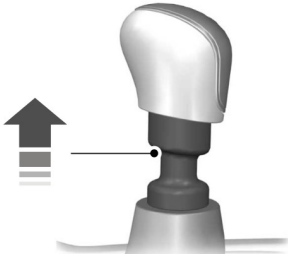

E99067

On some vehicles it is necessary to raise the collar whilst selecting reverse gear.

See **Manual Transmission** (page 162).

Automatic transmission

Note: Do not press the brake pedal when removing the key from the ignition switch.

Selector lever positions

WARNING



Apply the brakes before moving the selector lever and keep them applied until you are ready to move off.

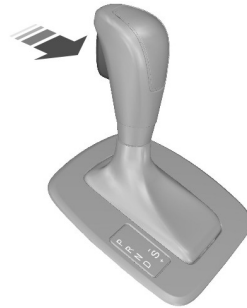

E80836

- P Park
- R Reverse
- N Neutral
- D Drive
- S Manual shifting and sport mode

See **Automatic Transmission** (page 162).

Electric parking brake (EPB)

Releasing the EPB manually

Note: To release the EPB, the ignition must be in position II.

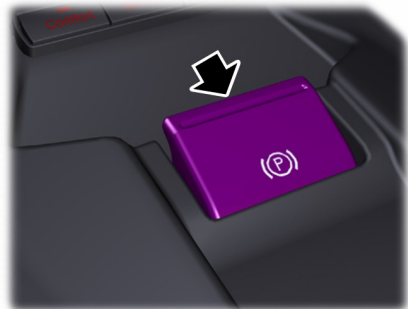

E70529

At a Glance

Hold the brake pedal depressed and press down the switch.

Automatic release - Drive away release (DAR)

Note: *On vehicles with automatic transmission, the driver's door must be closed and the driver's seatbelt must be fastened before the DAR will operate.*

Engage first or reverse gear, move off as normal, the EPB will be released automatically.

See **Electric Parking Brake** (page 166).

Rear view camera

WARNING



The camera does not relieve you of your responsibility to drive with due care and attention.

The camera is a visual aid for use when reversing.

S-MAX



E99105

Galaxy



E124349

See **Rear view camera** (page 176).

Speed limiter

The system allows you to set a speed, to which the vehicle then becomes limited.

See **Speed Limiter** (page 187).

Driver alert

WARNING



The system does not relieve you of your responsibility to drive with due care and attention.

The system calculates an alertness score which can be displayed on the information display. If the system detects that you are becoming drowsy or there is deterioration in your driving style then warnings will be issued.

See **Driver Alert** (page 189).

At a Glance

Lane departure warning

WARNING



The system does not relieve you of your responsibility to drive with due care and attention.

Activate the system using the switches on the indicator stalk.



E131360

- A System on
- B System off

See **Lane Departure Warning** (page 191).

Towing the vehicle on four wheels

CAUTION



For certain engine and transmission combinations, it is recommended not to tow the vehicle with the drive wheels on the ground.

See **Towing the Vehicle on Four Wheels** (page 231).

Child Safety

CHILD SEATS







E133140





E68916

WARNINGS

-  Secure children that are less than 150 centimetres (59 inches) tall in a suitable, approved child restraint, in the rear seat.
-  **Extreme Hazard!** Do not use a rearward facing child restraint on a seat protected by an air bag in front of it!
-  Read and follow the manufacturer's instructions when you are fitting a child restraint.
-  Do not modify child restraints in any way.
-  Do not hold a child on your lap when the vehicle is moving.

WARNINGS

-  Do not leave unattended children in your vehicle.
-  If your vehicle has been involved in an accident, have the child restraints checked by properly trained technicians.

Note: *Mandatory use of child restraints varies from country to country.*

Only child restraints certified to ECE-R44.03 (or later) have been tested and approved for use in your vehicle. A choice of these are available from your Dealer.

Child restraints for different mass groups

Use the correct child restraint as follows:

Baby safety seat



E68918

Secure children that weigh less than 13 kilograms (29 pounds) in a rearward facing baby safety seat (Group 0+) in the rear seat.

Child Safety

Child safety seat





E68920

Secure children that weigh between 13 and 18 kilograms (29 and 40 pounds) in a child safety seat (Group 1) in the rear seat.

BOOSTER SEATS

WARNINGS

-  Do not install a booster seat or a booster cushion with only the lap strap of the seat belt.
-  Do not install a booster seat or a booster cushion with a seat belt that is slack or twisted.
-  Do not put the seat belt under your child's arm or behind its back.
-  Do not use pillows, books or towels to boost your child's height.
-  Make sure that your children sit in an upright position.
-  Secure children that weigh more than 15 kilograms (33 pounds) but are less than 150 centimetres (59 inches) tall in a booster seat or a booster cushion.

CAUTION

-  When using a child seat on a rear seat, make sure that the child seat rests tightly against the vehicle seat. It may be necessary to lift or remove the head restraint. See **Head Restraints** (page 128).

Booster seat (Group 2)



E70710

We recommend that you use a booster seat that combines a cushion with a backrest instead of a booster cushion only. The raised seating position will allow you to position the shoulder strap of the adult seat belt over the centre of your child's shoulder and the lap strap tightly across its hips.

Child Safety



Booster cushion (Group 3)







E68924

CHILD SEAT POSITIONING

WARNINGS

-  Please consult your Dealer for the latest details relating to Ford recommended child seats.
-  When you are using a group 0 or 0+ child seat with a support leg on a second row seat, make sure that you locate the support leg securely on the under floor storage compartment cover. Make sure that you install the foam spacer correctly inside the storage compartment, using any screws or fastenings provided and, that you position the cover correctly.
-  If the under floor storage compartment foam spacer is damaged or missing, remove the storage compartment cover and extend the leg to the base of the compartment. If it is not possible to locate the leg securely on the base of the compartment, for example because of the shape or length of the leg, replace the foam spacer and compartment cover or select a different seating position in the vehicle.

WARNINGS

-  If you want to use a child seat with a support leg, consult the child seat manufacturer's website or fitting instructions. You must make sure the child seat is compatible with your vehicle. Check for any special fitting instructions regarding the removal of the under floor storage compartment cover or the position of the second row seats.
-  On certain vehicles it is not possible to open or remove the left-hand compartment cover. See **Storage compartments** (page 139). For group 0 or 0+ child seats, this does not prevent the support leg being located on the cover. However, if any larger child seat that you may wish to use requires you to remove the cover and extend the leg to the base of the compartment, either select a different seating position in the vehicle or a different child seat.
-  When using a forward facing child seat on a second or third row seat, always remove the head restraint from that seat. See **Head Restraints** (page 128).
-  When using a child seat with a seat belt, make sure that the seat belt is not slack or twisted.

Note: When using a child seat on a front seat, always adjust the front passenger seat to its fully rearwards position. If it proves difficult to tighten the lap section of the seat belt without slack remaining, adjust the seatback to the fully upright position and raise the height of the seat. See **Manual Seats** (page 125). See **Power Seats** (page 126).

Note: When using a child seat on a second row seat, adjust the second row seat to the most practical position for the driver. See **Rear Seats** (page 128).

Child Safety

Child seat positions

Seating positions	Mass group categories				
	0	0+	1	2	3
	Up to 10 kg	Up to 13 kg	9 - 18 kg	15 - 25 kg	22 - 36 kg
	Baby safety seat		Child safety seat	Booster seat or cushion	
Front passenger seat with airbag ON	X	X	UF ¹	UF ¹	UF ¹
Front passenger seat with airbag OFF	U ¹	U ¹	U ¹	U ¹	U ¹
Second row seats	U	U	U	U	U
Third row Galaxy	U	U	U	U	U
Third row S-MAX	L, UF	L, UF	UF	UF	UF

X Not suitable for children in this mass group.

U Suitable for universal category child restraints approved for use in this mass group.

U¹ Suitable for universal category child restraints approved for use in this mass group. However, we recommend that you secure children in a government approved child restraint, in the rear seat.

L Suitable only for the following rearward facing child restraints: Roemer Baby-Safe (E1-04301146), Roemer Baby-Safe Plus (E1-04301146), Britax Cosy Tot (E1-04301146), Britax Cosy Tot Premium (E1-04301146), Maxi-Cosi Cabrio (E4-44R-043517).

UF Suitable for universal category forward facing child restraints approved for use in this mass group.

UF¹ Suitable for universal category forward facing child restraints approved for use in this mass group. However, we recommend that you secure children in a government approved child restraint, in the rear seat.

Child Safety

ISOFIX child seats

Seating positions		Mass group categories	
		O+	1
		Rear facing	Forward facing
		Up to 13 kg	9 - 18 kg
Front seat	Size class	Not ISOFIX equipped	
	Seat type		
Second row seats	Size class	C, D, E*	A, B, B1, C, D*
	Seat type	IL**	IL, IUF***
Third row rear seats	Size class	Not ISOFIX equipped	
	Seat type		

IL Suitable for particular ISOFIX child restraints systems of the **semi-universal** category. Please consult child restraints systems suppliers' vehicle recommendation lists.

IUF Suitable for ISOFIX forward facing child restraints systems of **universal** category approved for use in this mass group and ISOFIX size class.

*The ISOFIX size class for both **universal** and **semi-universal** child restraints systems is defined by the capital letters **A** to **G**. These identification letters are displayed on ISOFIX child restraints.

**At time of publishing the recommended Group O+ ISOFIX baby safety seat is the Britax Romer Baby Safe. Please consult your Dealer for the latest details relating to Ford recommended child seats.

***At time of publishing the recommended Group 1 ISOFIX child seat is the Britax Romer Duo. Please consult your Dealer for the latest details relating to Ford recommended child seats.

Child Safety

ISOFIX ANCHOR POINTS

WARNING

 Use an anti-rotation device when using the ISOFIX system. We recommend the use of a top tether or support leg.

Note: When you are purchasing an ISOFIX restraint, make sure that you know the correct mass group and ISOFIX size class for the intended seating locations. See **Child Seat Positioning** (page 23).

Your vehicle is fitted with ISOFIX anchor points that accommodate universally approved ISOFIX child restraints.

The ISOFIX system comprises two rigid attachment arms on the child restraint that attach to anchor points on the outboard rear seats, where the cushion and backrest meet. Tether anchor points are fitted behind the outboard rear seats for child restraints with a top tether.

Top tether anchor points



E75532



Attaching a child seat with top tethers

WARNING

 Do not attach a tether strap to anything other than the correct tether anchor point.

Note: Where applicable, remove the luggage cover to ease installation. See **Luggage Covers** (page 201).

1. Remove the head restraint. See **Head Restraints** (page 128).

WARNING

 Make sure that the top tether strap is not slack or twisted and is properly located on the anchor point.

2. Route the tether strap to the anchor point.

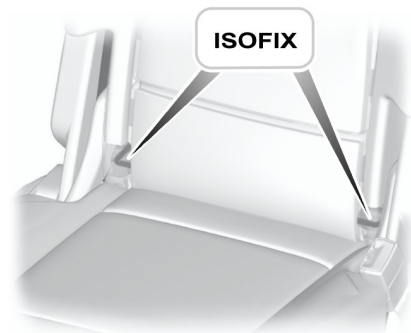

E75531

3. Push the child seat back firmly to engage the ISOFIX lower anchor points.
4. Tighten the tether strap in line with the child seat manufacturer's instructions.

Child Safety

CHILD SAFETY LOCKS

WARNING



You cannot open the doors from inside if you have put the child safety locks on.

Manual child safety locks

Note: On vehicles with keyless entry, use the spare key. See **Keyless Entry** (page 40).



E78298

Left-hand side

Turn anti-clockwise to lock and clockwise to unlock.

Right-hand side

Turn clockwise to lock and anti-clockwise to unlock.

Electric child safety locks

Note: Pressing the switch will also disable the rear electric window switches.



E124779

Occupant protection

PRINCIPLE OF OPERATION

Airbags

WARNINGS



Do not modify the front of your vehicle in any way. This could adversely affect deployment of the airbags.



Original text according to ECE R94.01: Extreme Hazard! Do not use a rearward facing child restraint on a seat protected by an airbag in front of it!



Wear a seat belt and keep sufficient distance between yourself and the steering wheel. Only when you use the seat belt properly, can it hold you in a position that allows the airbag to achieve its optimum effect. See **Sitting in the Correct Position** (page 125).



Have repairs to the steering wheel, steering column, seats, airbags and seat belts carried out by a properly trained technician.



Keep the areas in front of the airbags free from obstruction. Do not affix anything to or over the airbag covers.



Do not poke sharp objects into areas where airbags are fitted. This could damage and adversely affect deployment of the airbags.



Use seat covers designed for seats with side airbags. Have these fitted by a properly trained technician.

Note: You will hear a loud bang and see a cloud of harmless powdery residue if an airbag deploys. This is normal.

Note: Only wipe airbag covers with a damp cloth.

Driver and front passenger airbags

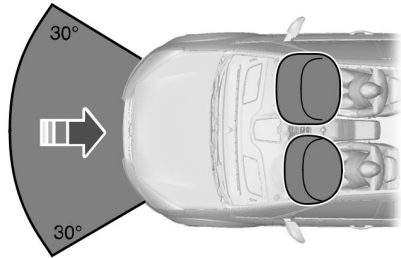

E74302

The driver and front passenger airbags will deploy during significant frontal collisions or collisions that are up to 30 degrees from the left or the right. The airbags will inflate within a few thousandths of a second and deflate on contact with the occupants, thus cushioning forward body movement. During minor frontal collisions, overturns, rear collisions and side collisions, the driver and front passenger airbags will not deploy.

Driver knee airbag

CAUTION



Do not attempt to open the driver knee airbag cover.

The driver knee airbag will deploy during frontal collisions or collisions that are up to 30 degrees from the left or the right. The airbag will inflate within a few thousandths of a second and deflate on contact with the occupants, thus providing a cushion between the driver's knees and the steering column. During overturns, rear collisions and side collisions, the knee airbag will not deploy.

For item location: See **At a Glance** (page 9).

Occupant protection

Note: The knee airbag has a lower deployment threshold than the front airbags. During a minor collision, it is possible that only the knee airbag deploys.

Side airbags



E72658

Side airbags are fitted inside the seatback of the front seats. A label indicates that side airbags are fitted to your vehicle.

The side airbags will deploy during significant lateral collisions. The airbags will inflate within a few thousandths of a second and deflate on contact with the occupants, thus providing protection for the chest and shoulder areas. During minor lateral collisions, overturns, front collisions and rear collisions, the side airbags will not deploy.

Curtain airbags

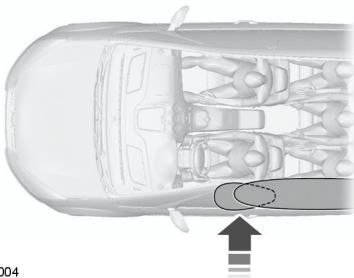







E75004

Curtain airbags are fitted inside the trim panels over the front and rear side windows. Moulded badges in the B-pillar trim panels indicate that curtain airbags are fitted to your vehicle.

The curtain airbags will deploy during significant lateral collisions. The airbag will inflate within a few thousandths of a second and deflate on contact with the occupants, thus providing protection for the head. During minor lateral collisions, front collisions, rear collisions, or overturns the curtain airbags will not deploy.

Seat belts

WARNINGS

-  Wear a seat belt and keep sufficient distance between yourself and the steering wheel. Only when you use the seat belt properly, can it hold you in a position to achieve its optimum effect. See **Sitting in the Correct Position** (page 125).
-  Never use a seat belt for more than one person.
-  Use the correct buckle for each seat belt.
-  Do not use a seat belt that is slack or twisted.
-  Do not wear thick clothing. The seat belt must fit tightly around your body to achieve its optimum effect.
-  Position the shoulder strap of the seat belt over the centre of your shoulder and position the lap strap tightly across your hips.

Occupant protection

The driver and front passenger seat belt retractors are fitted with a seat belt pretensioner. Seat belt pretensioners have a lower deployment threshold than the airbags. During minor collisions, it is possible that only the seat belt pretensioners will deploy.

Status after a collision

WARNING



Seat belts subjected to strain, as a result of an accident, should be renewed and the anchorages checked by a properly trained technician.

FASTENING THE SEAT BELTS

WARNING



Insert the tongue into the buckle until you hear a distinct click. You have not fastened the seat belt properly if you do not hear a click.

Note: *The seat belt tongues are designed so that you can only insert them into the correct buckle.*



E74124



E74127

Pull the belt out steadily. It may lock if you pull it sharply or if the vehicle is on a slope. Press the red button on the buckle to release the belt. Let it retract completely and smoothly.

Second row centre seat belt

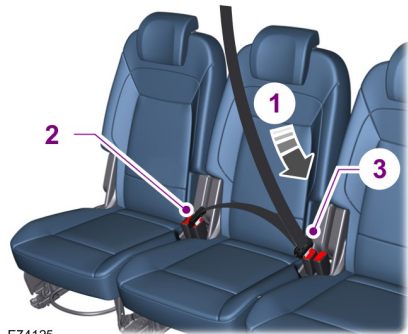

E74125

The retractor for the rear centre seat belt is located in the roof.

To fasten the seat belt:

Occupant protection

1. Pull the belt out steadily. It may lock if you pull it sharply or if the vehicle is on a slope.
2. Insert the smaller tongue into the black buckle to the right of the centre seat.
3. Pull the larger tongue across the lap and insert it into the buckle to the left of the centre seat.

Note: *If in constant use, you can leave the belt buckled in the black buckle. When it is not in use, or when you fold or move the rear seats, you should release the belt from the black buckle.*

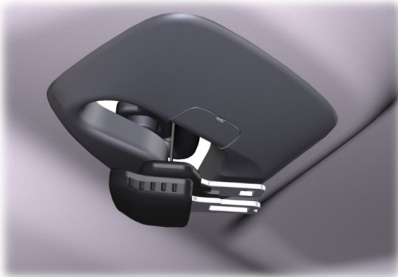

E74128

Press the red button on the left buckle to release the belt. Let it retract.

Press the button on the side of the black buckle to release the belt. Let it retract completely and smoothly to the retractor in the roof.

SEAT BELT HEIGHT ADJUSTMENT



E73135

To raise the height, grasp the D-ring and move the pivot up.

To lower the height, grasp the D-ring, hold the locking button on the height adjuster pressed and move the pivot down.

Note: *Lifting the slider slightly while pressing the locking button makes it easier to release the locking mechanism.*

SEAT BELT REMINDER

WARNING



The occupant protection system will only provide optimum protection when you use the seat belt properly.



The seat belt reminder warning lamp illuminates and an audible warning will sound if the driver's or front seat passenger's seat belt has not been fastened and the vehicle exceeds a relatively low speed. It will also illuminate if the driver's or front seat passenger's seat belt is unfastened when the vehicle is moving. The audible warning and warning lamp will go off after seven minutes.

Occupant protection

Deactivating the seat belt reminder

See your dealer.

USING SEAT BELTS DURING PREGNANCY

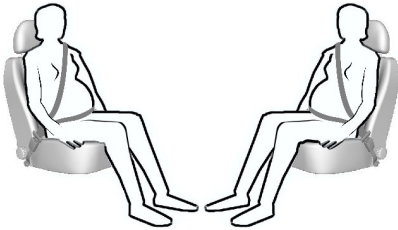

E68587

WARNING



Position the seat belt correctly for your safety and that of your unborn child. Do not use only the lap strap or the shoulder strap.

Position the lap strap comfortably across your hips and low beneath your pregnant abdomen. Position the shoulder strap between your breasts, above and to the side of your pregnant abdomen.

DISABLING THE PASSENGER AIRBAG

WARNING



Make sure that the passenger airbag is disabled when using a rearward facing child restraint on the front passenger seat.



E71313

Fitting the passenger airbag deactivation switch

WARNING



If you need to fit a child restraint on a seat protected by an operational airbag in front of it, have a passenger airbag deactivation switch fitted. Ask your dealer for further information.

Note: The key switch is located in the glove compartment with an airbag deactivation lamp in the instrument panel.

If the airbag warning lamp illuminates or flashes when you are driving, this indicates a malfunction. See **Warning Lamps and Indicators** (page 84). Remove the child restraint and have the system checked immediately.

Disabling the passenger airbag

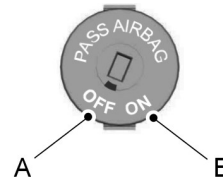

E71312

- A Disabled
- B Enabled

Occupant protection

Turn the switch to position **A**.

When you switch the ignition on, check that the passenger airbag deactivation warning lamp illuminates.

Enabling the passenger airbag

WARNING



Make sure that the passenger airbag is enabled when you are **not** using a child restraint on the front passenger seat.

Turn the switch to position **B**.

Keys and Remote Controls

GENERAL INFORMATION ON RADIO FREQUENCIES

CAUTIONS

! The radio frequency used by your remote control can also be used by other short distance radio transmissions (e.g. amateur radios, medical equipment, wireless headphones, remote controls and alarm systems). If the frequencies are jammed, you will not be able to use your remote control. You can lock and unlock the doors with the key.

! Check your vehicle is locked before leaving it unattended. This will safeguard against any potential malicious frequency blocking.

Note: You could unlock the doors if you press the buttons on the remote control unintentionally.

The operating range between your remote control and your vehicle varies depending on the environment.

PROGRAMMING THE REMOTE CONTROL

You can programme a maximum of eight remote controls to use with your vehicle (including any supplied with your vehicle).

Programming a new remote control

1. Insert the key in the ignition.
2. Cycle the key from position **0** to **II** and then back to **0** four times within six seconds.
3. Leave the key in position **0** and press any button on the remote control within 10 seconds. You will receive confirmation via a chime or LED that programming has been successful.

Note: Further remote controls may be programmed at this stage.

4. Press any button on each additional remote control within 10 seconds of each other.

Reprogramming the unlocking function

Note: When you press the unlock button either all the doors are unlocked or only the driver's door is unlocked. Pressing the unlock button again unlocks all the doors.

Press and hold the unlock and lock buttons on the remote key simultaneously for at least four seconds with the ignition off. The direction indicators will flash twice to confirm the change.

To return to the original unlocking function, repeat the process.

CHANGING THE REMOTE CONTROL BATTERY



Make sure that you dispose of old batteries in an environmentally friendly way.

Seek advice from your local authority regarding recycling.

Remote control with a folding key blade

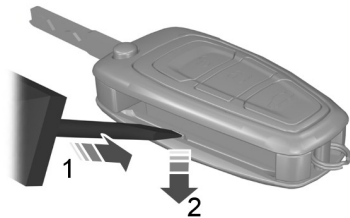

E128809

Keys and Remote Controls

1. Insert a screwdriver in the position shown and gently push the clip.
2. Press the clip down to release the battery cover.

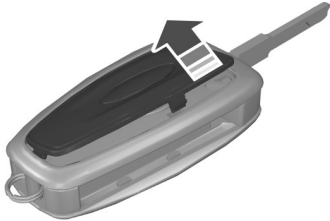

E128810

3. Carefully remove the cover.

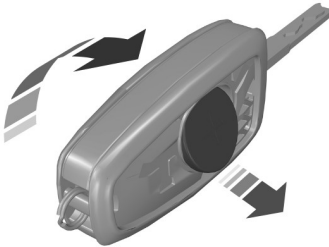

E128811

4. Turn the remote control over to remove the battery.
5. Install a new battery (3V CR 2032) with the + facing upwards.
6. Replace the battery cover.

Remote control without a folding key blade

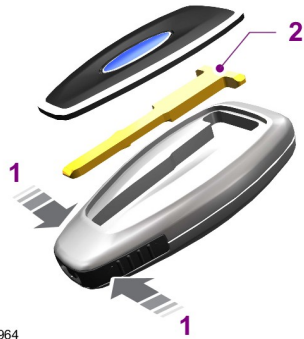

E87964

1. Press and hold the pushbuttons on the edges to release the cover. Carefully remove the cover.
2. Remove the key blade.

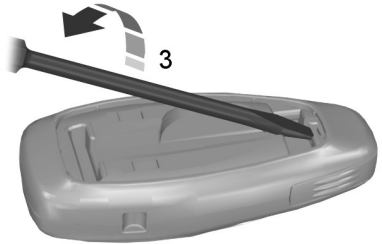

E105362

3. Twist a flat bladed screwdriver in the position shown to separate the two halves of the remote control.

Keys and Remote Controls



E119190

- Carefully insert the screwdriver in the position shown to open the remote control.

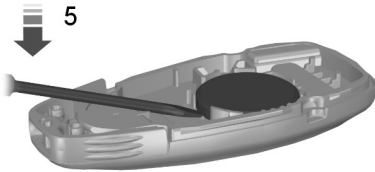

E125860

CAUTION

-  Do not touch the battery contacts or the printed circuit board with the screwdriver.

- Carefully prise out the battery with the screwdriver.
- Install a new battery (3V CR 2032) with the **+** facing downwards.
- Assemble the two halves of the remote control.
- Install the key blade.

Locks

LOCKING AND UNLOCKING

CAUTION

 Check your vehicle is locked before leaving it unattended.

Central locking

You can only centrally lock the doors if they are all closed.

Note: *The driver's door can be unlocked with the key. This needs to be used if the remote control is not functioning.*

Note: *Central locking also locks and unlocks the fuel filler flap.*

Double locking

WARNING

 Do not activate double locking when persons or animals are inside the vehicle. You will not be able to unlock the doors from the inside if you have double locked them.



E71961

Double locking is a theft protection feature that prevents someone from opening the doors from the inside. You can only double lock the doors if they are all closed.

Locking and unlocking confirmation

When you unlock the doors, the direction indicators will flash once.

When you lock the doors, the direction indicators will flash twice.

Locking and unlocking the doors with the key

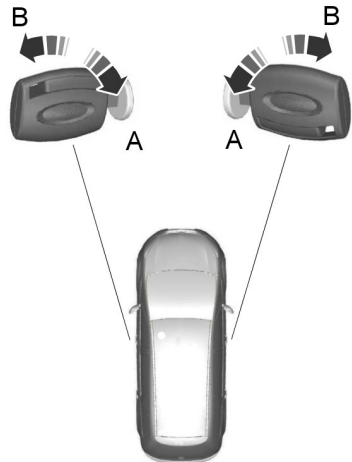

E71962

- A Unlock
- B Lock

Double locking the doors with the key

Turn the key to the lock position twice within three seconds to double lock the doors.

Locks

Locking and unlocking the doors and the luggage compartment lid with the remote control

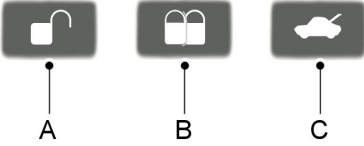

E87379

- A Unlock
- B Lock
- C Luggage compartment lid unlock (press twice)

Locking the doors and the luggage compartment lid with the remote control

Press button **B** once.

Double locking the doors and the luggage compartment lid with the remote control

Press button **B** twice within three seconds.

Locking and unlocking the doors from inside

Driver's door

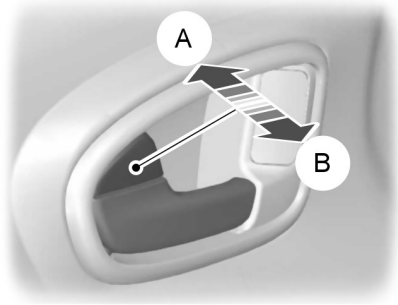

E71958

- A Lock all doors
- B Unlock all doors

Front and rear passenger doors



E98653

To lock the front and rear passenger doors individually, press the button and close the door when leaving the vehicle.

Locks

Luggage compartment lid

Opening the luggage compartment lid



E125429

Opening the luggage compartment lid with the remote control

Press button **C** on the remote control twice within three seconds.

Closing the luggage compartment lid



E71960

A recessed grip is incorporated inside the luggage compartment lid to facilitate closing.

Automatic relocking

The doors will relock automatically if you do not open a door within 45 seconds of unlocking the doors with the remote control. The door locks and the alarm will return to their previous state.

Reprogramming the unlocking function

The unlocking function may be reprogrammed so that only the driver's door is unlocked. See **Programming the remote control** (page 34).

GLOBAL OPENING AND CLOSING

You can also operate the electric windows with the ignition off via the global opening and global closing function.

Note: *Global closing will only operate if you have set the memory correctly for each window. See **Power Windows** (page 74).*

Global opening

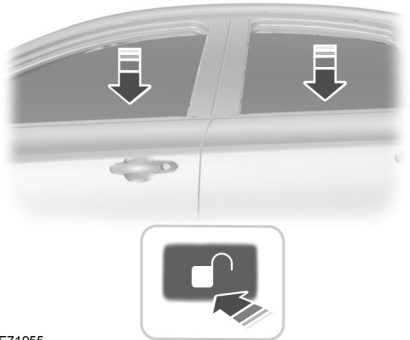

E71955

To open all the windows, press and hold the **unlock** button for at least three seconds. Press either the **lock** or the **unlock** button again to stop the opening function.

Locks

Global closing

Vehicles without keyless entry

WARNING



Take care when using global closing. In an emergency, press a button immediately to stop.

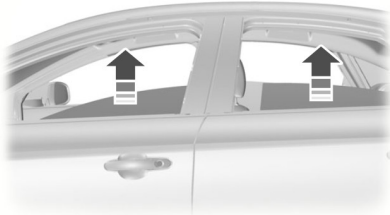

E71956

To close all the windows, press and hold the **lock** button for at least three seconds. Press any button again to stop the closing function. The anti-trap function is also active during global closing.

Vehicles with keyless entry

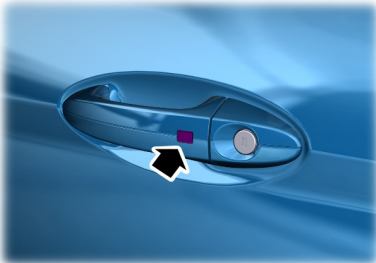

E87384

WARNING



Take care when using global closing. In an emergency, press the button on the driver's door handle to stop.

Note: *Global closing can be activated using the button on the driver's door handle. Global opening and closing can also be activated using the buttons on the passive key.*

To close all the windows, press and hold the button on the driver's door handle for at least two seconds. The anti-trap function is also active during global closing.

KEYLESS ENTRY

General information

WARNING



The keyless entry system may not function if the key is close to metal objects or electronic devices such as mobile phones.

Note: *If the door handles are pulled repeatedly during a short period of time without the presence of a valid passive key, the system will become inoperable for 30 seconds.*

The passive entry system will not function if:

- The passive key frequencies are jammed.
- The passive key battery is flat.

Note: *If the passive entry system does not function, you will need to use the key blade to lock and unlock your vehicle.*

The keyless system allows the driver to operate the vehicle without the use of a key or remote control.

Locks

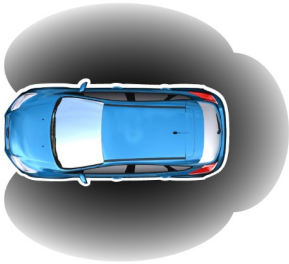

E78276

Passive locking and unlocking requires a valid passive key to be located within one of the three external detection ranges. These are located approximately one and a half metres from the driver and front passenger door handles and the luggage compartment lid.

Passive key

The vehicle can be locked and unlocked with the passive key. The passive key can also be used as a remote control. See

Locking and Unlocking (page 37).

Locking the vehicle

WARNING



The vehicle does not lock itself automatically. If no locking button is pressed, the vehicle will remain unlocked.

Note: The ignition will automatically switch off when you lock your vehicle from the outside. This is to prevent the vehicle battery from discharging.

Note: If locking from the luggage compartment lid, the passive key must be within the luggage compartment lid detection range.

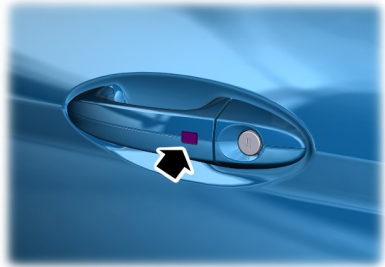

E87384

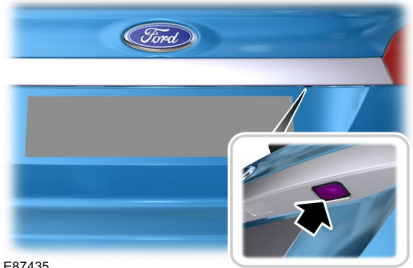

E87435

Locking buttons are located on each of the front doors and the luggage compartment lid.

To activate central locking and arm the alarm:

- Press a locking button once.

To activate double locking, to arm the alarm and the interior sensors:

- Press a locking button twice within three seconds.

Note: Once activated, the vehicle will remain locked for approximately three seconds. This is to allow you to pull a door handle and check if the vehicle is locked. When the delay period is over, the doors can be opened again, provided the passive key is within the respective detection range.

Locks

Luggage compartment lid

Note: *The luggage compartment lid cannot be closed and will pop back up if the passive key is located inside the luggage compartment.*

Note: *If a second valid passive key is located within the luggage compartment lid detection range, the luggage compartment lid can be closed.*

Unlocking the vehicle

Note: *If the vehicle remains locked for longer than five days, the system will enter an energy-saving mode. This is to reduce the discharge of the vehicle battery. When the vehicle is unlocked while in this mode, the reaction time of the system may be a little longer than normal. Unlocking the vehicle once will deactivate the energy-saving mode.*

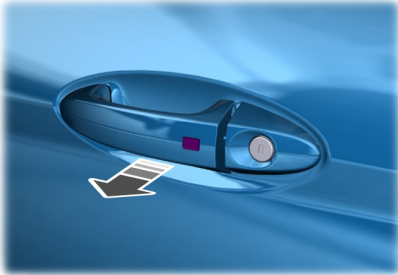

E78278

Pull one of the door handles or the luggage compartment lid handle.

Note: *A valid passive key must be located within the detection range of that door.*

One long flash of the direction indicators confirms that all the doors, the luggage compartment lid and the fuel filler flap have been unlocked and that the alarm has been disarmed.

Unlocking only the driver's door

If the unlocking function is reprogrammed so that only the driver's door is unlocked (See **Keys and Remote Controls** (page 34).), note the following:

If the driver's door is the first door which is opened, the other doors and the luggage compartment lid will remain locked. Doors can be unlocked individually by pulling the interior door handles on those doors.

If the front passenger door or one of the rear doors is the first door which is opened, **all** the doors and the luggage compartment lid will be unlocked.

Disabled keys

Any keys left inside the vehicle interior when it is locked will be disabled.

A disabled key cannot be used to turn the ignition on or start the engine.

In order to use these passive keys again, they have to be enabled.

To enable all your passive keys, unlock the vehicle using a passive key or the remote control unlocking function.

All passive keys will then be enabled if the ignition is turned on or the vehicle is started using a valid key.

Locks

Locking and unlocking the doors with the key blade

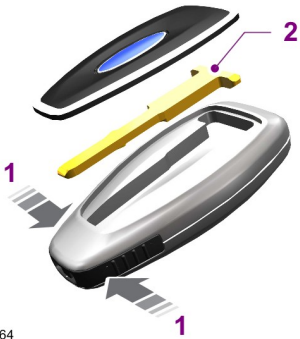

E87964

1. Carefully remove the cover.
2. Remove the key blade and insert it into the lock.

Engine immobiliser

PRINCIPLE OF OPERATION

The engine immobiliser is a theft protection system that prevents someone from starting the engine with an incorrectly coded key.

If you are unable to start the engine with a correctly coded key, this indicates a malfunction. The message **Immobiliser active** will appear in the information display when you switch on the ignition. Have the immobiliser checked immediately.

CODED KEYS

Note: *Do not shield your keys with metal objects. This may prevent the receiver from recognising your key as a valid one.*

Note: *Have all of your remaining keys erased and recoded if you lose a key. Ask your dealer for further information. Have replacement keys recoded together with your existing keys.*

If you lose a key, you can obtain a replacement from your Ford Dealer. If possible, provide them with the key number from the tag provided with the original keys. You can also obtain additional keys from your Ford Dealer.

ARMING THE ENGINE IMMOBILISER

The engine immobiliser is armed automatically a short time after you have switched the ignition off.

DISARMING THE ENGINE IMMOBILISER

The engine immobiliser is disarmed automatically when you switch the ignition on with a correctly coded key.

If the message **Immobiliser active** appears in the information display, your key has not been recognised. Remove the key and try again.

Alarm

PRINCIPLE OF OPERATION

Alarm system

Your vehicle may be equipped with one of the following alarm systems:

- Perimeter alarm.
- Perimeter alarm with interior sensors.
- Category one alarm with interior sensors and battery back-up sounder.
- Category one alarm with interior sensors, battery back-up sounder and tilt sensors.

Perimeter alarm

The perimeter alarm is a deterrent against unauthorised access to your vehicle through the doors and the bonnet. It also protects the audio unit.

Interior sensors

Vehicles without overhead console



E71401

Vehicles with overhead console

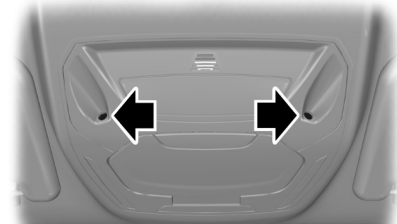

E131656

WARNING



The sensors must not be covered up. Do not activate the alarm with full guard if any persons, animals or other moving objects are inside the vehicle.

The sensors act as a deterrent against unauthorised intrusion by sensing any movement within the vehicle.

Battery back-up sounder

The battery back-up sounder is an extra alarm system which will sound a siren when the alarm is triggered. It is armed directly when you lock the vehicle. The sounder has its own battery and will sound an alarm siren even if someone disconnects the vehicle battery or the battery back-up sounder itself.

Tilt sensors

The tilt sensors detect if someone attempts to steal a wheel or tow the vehicle away by sensing changes in the inclination of the vehicle.

Note: *When travelling on a ferry with the alarm armed, deactivate the tilt sensors by selecting reduced guard. This will prevent the alarm from being triggered by the movement.*

Triggering the alarm

Once armed, the alarm is triggered in any of the following ways:

- If someone opens a door, the tailgate or the bonnet without a valid key or remote control.
- If someone removes the audio or navigation system.
- If the ignition is turned to position **I**, **II** or **III** without a valid key.
- If the interior sensors detect movement within the vehicle.

Alarm

- On vehicles with a battery back-up sounder, if someone disconnects the vehicle battery or the battery back-up sounder itself.
- If the tilt sensors detect a change in the inclination of the vehicle.

If the alarm is triggered, the alarm horn will sound for 30 seconds and the hazard warning flasher will flash for five minutes.

Any further attempts to perform one of the above will trigger the alarm again.

Full and reduced guard

Full guard

Full guard is the standard setting.

In full guard, the interior and tilt sensors are activated when you arm the alarm.

Note: This may result in false alarms if animals or moving objects are inside the vehicle or, on vehicles with tilt sensors, when travelling on a ferry.

Note: False alarms can also be triggered by the auxiliary heater. See **Auxiliary Heater** (page 119). If you are using the auxiliary heater, direct the air flow towards the footwell.

Reduced guard

In reduced guard, the interior and tilt sensors are deactivated when you arm the alarm.

Note: You can set the alarm to reduced guard for the current ignition cycle only. The next time you switch on the ignition, the alarm will be reset to full guard.

Ask on Exit

You can set the information display to ask you each time which level of guard you wish to set.

If you select **Ask on Exit**, the message **Reduced guard?** appears in the instrument cluster display each time you switch the ignition off.

If you wish to arm the alarm with reduced guard, press the **OK** button when this message appears.

If you wish to arm the alarm with full guard, leave the vehicle without pressing the **OK** button.

Selecting full or reduced guard

Note: Selecting **Reduced** does not set the alarm permanently to reduced guard. It sets it to reduced guard only for the current ignition cycle. If you regularly set the alarm to reduced guard, select **Ask on Exit**.



E70499

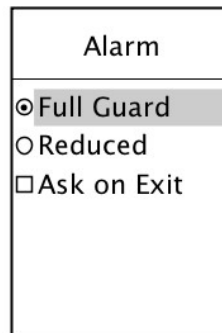

E74509

Alarm

1. Press the right arrow button on the steering wheel to enter the main menu.
2. Highlight **Setup** with the up and down arrow buttons and press the right arrow button.
3. Highlight **Alarm** and press the right arrow button.
4. Highlight **Reduced** or **Full guard**. If you prefer to be asked each time you switch off the ignition, select **Ask on Exit**.
5. Press the **OK** button to confirm the selection.
6. Press the left arrow button to exit the menu. To return to the trip computer display directly, hold the left arrow button pressed.

Information messages

See **Information Messages** (page 101).

ARMING THE ALARM

To arm the alarm, lock the vehicle. See **Locks** (page 37).

DISARMING THE ALARM

Vehicles without keyless entry

Perimeter alarm

Disarm and silence the alarm by unlocking the doors with the key and switching the ignition on with a correctly coded key, or unlocking the doors or the luggage compartment lid with the remote control.

Category one alarm

Disarm and silence the alarm by unlocking the doors with the key and switching the ignition on with a correctly coded key within 12 seconds, or unlocking the doors or the luggage compartment lid with the remote control.

Vehicles with keyless entry

Note: A valid passive key must be located within the detection range of that door for keyless entry. See **Keyless Entry** (page 40).

Perimeter alarm

Disarm and silence the alarm by unlocking the doors and switching the ignition on, or unlocking the doors or the luggage compartment lid with the remote control.

Category one alarm

Disarm and silence the alarm by unlocking the doors and switching the ignition on within 12 seconds, or unlocking the doors or the luggage compartment lid with the remote control.

Steering Wheel

ADJUSTING THE STEERING WHEEL

WARNING

 Never adjust the steering wheel when the vehicle is moving.

Note: Make sure that you are sitting in the correct position. See **Sitting in the Correct Position** (page 125).

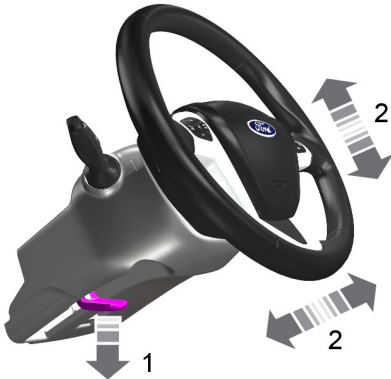

E95178



E95179

WARNING

 Make sure that you fully engage the locking lever when returning it to its original position.

AUDIO CONTROL

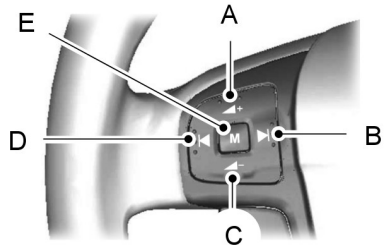

E72288

- A Volume up
- B Seek up
- C Volume down
- D Seek down
- E Mode

Mode

Press and **hold** the mode button to select the audio source.

Press the mode button to:

- tune the radio to the next preset station
- play the next CD
- play the other side of a cassette tape
- accept an incoming telephone call.
- end a telephone call.

Steering Wheel

Seek

Press a seek button to:

- tune the radio to the next station up or down the frequency band
- play the next or the previous CD track
- fast forward or rewind the cassette tape.

Press and **hold** a seek button to:

- tune the radio up or down the frequency band
- seek through a CD track.

Wipers and Washers

WINDSCREEN WIPERS

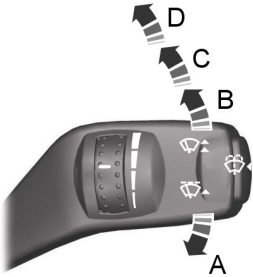

E70696

- A Single wipe
- B Intermittent wipe
- C Normal wipe
- D High speed wipe

Intermittent wipe

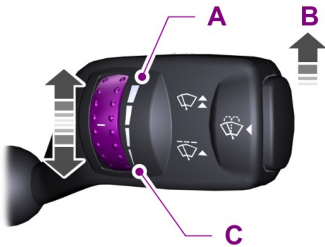

E70315

- A Short wipe interval
- B Intermittent wipe
- C Long wipe interval

AUTOWIPERS

CAUTIONS

- ⚠ Do not switch autowipers on in dry weather conditions. The rain sensor is very sensitive and the wipers may operate if dirt, mist or flies hit the windscreen.
- ⚠ Replace the wiper blades as soon as they begin to leave bands of water and smears. If you do not replace them, the rain sensor will continue to detect water on the windscreen and the wipers will operate, even though the majority of the windscreen is dry.
- ⚠ Fully defrost the windscreen in icy conditions before you switch autowipers on.
- ⚠ Switch autowipers off before you enter a car wash.

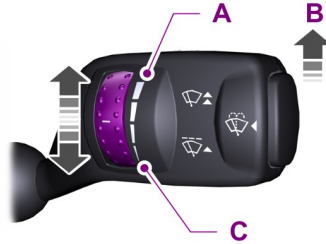

E70315

- A High sensitivity
- B On
- C Low sensitivity

If you switch autowipers on, the wipers will not cycle until water is detected on the windscreen. The rain sensor will then continuously measure the amount of water on the windscreen and adjust the speed of the wipers automatically.

Wipers and Washers

Adjust the sensitivity of the rain sensor using the rotary control. With low sensitivity, the wipers will operate when the sensor detects a lot of water on the windshield. With high sensitivity, the wipers will operate if the sensor detects a small amount of water on the windshield.

WINDSCREEN WASHERS

WARNING



Do not operate the windscreen washers for more than 10 seconds or when the reservoir is empty.

Note: *The washer jets are heated when the ignition is on.*

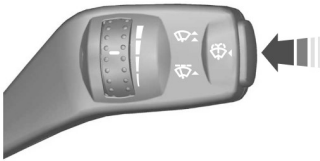

E70776

ADJUSTING THE WINDSCREEN WASHER JETS

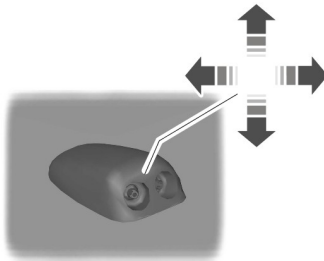

E73425

The eye ball jets can be adjusted precisely using a pin.

REAR WINDOW WIPER AND WASHERS

Intermittent wipe



E70777

Reverse gear wipe

The rear window wiper will operate automatically when you select reverse gear if the wiper lever is in position **B**, **C** or **D**.

Washer

WARNING



Do not operate the rear window washer for more than 10 seconds or when the reservoir is empty.



E70777

Pull the lever fully towards the steering wheel and hold it to operate the washer.

HEADLAMP WASHERS

The headlamp washers will operate with the windscreen washers when the headlamps are on.

Wipers and Washers

Note: To stop the washer fluid reservoir emptying quickly, the headlamp washers will not operate every time that you use the windscreen washers.

CHECKING THE WIPER BLADES

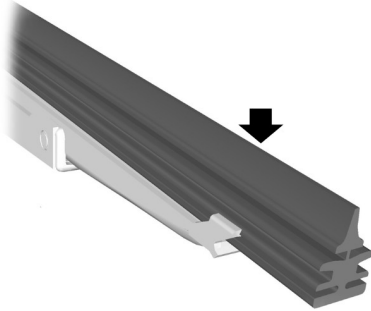

E66644

Run the tip of your fingers over the edge of the blade to check for roughness.

Clean the wiper blade lips with water applied with a soft sponge.

CHANGING THE WIPER BLADES

Windscreen wiper blades

CAUTIONS

- ❗ Set the windscreen wipers in the service position to change the wiper blades.
- ❗ You can use the service position in winter to provide easier access to the wiper blades for freeing them from snow and ice. Make sure that the outside of the windscreen is free from snow and ice before using the wipers.

Note: The windscreen wiper blades are different lengths. See **Technical Specifications** (page 53). If you install wiper blades of the wrong length, the rain sensor may not work correctly.

Set the windscreen wipers in the service position.

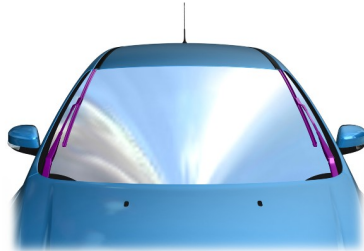

E75184



E75188

Switch off the ignition and move the wiper lever to position **A** within three seconds. Release the lever when the windscreen wipers have moved to the service position.

Lift the wiper arms.

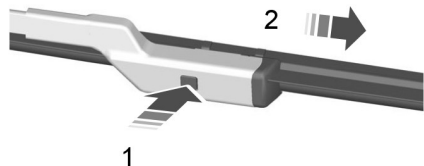

E72899

Install in the reverse order.

Wipers and Washers

Note: Make sure that the wiper blade locks into place.

Rear window wiper blades

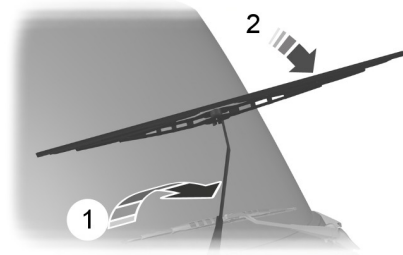

E93783

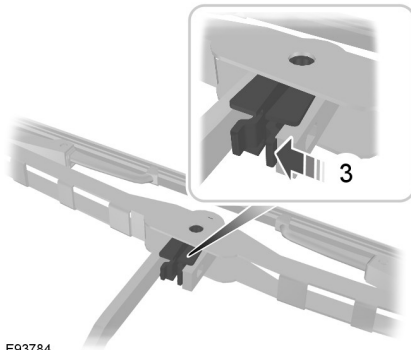

E93784

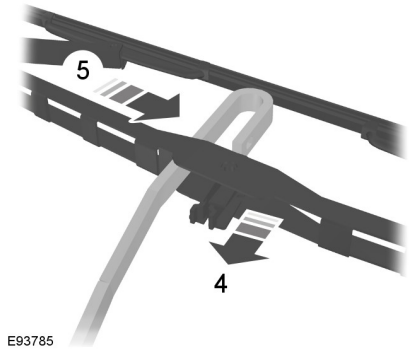

E93785

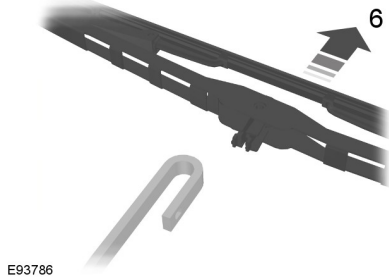

E93786

Install in the reverse order.

TECHNICAL SPECIFICATIONS

Windscreen wiper blade lengths

Item	Dimension in mm (inches)	
	Left-hand	Right-hand
Vehicles with autowipers	750 (29.5)	700 (27.6)
Vehicles without autowipers	750 (29.5)	650 (25.6)

Lighting

GENERAL INFORMATION

Condensation in Lamp Assemblies

Exterior lamps have vents to accommodate normal changes in air pressure.

Condensation can be a natural by-product of this design. When moist air enters the lamp assembly through the vents, there is a possibility that condensation can occur when the temperature is cold. When normal condensation occurs, a fine mist can form on the interior of the lens. The fine mist eventually clears and exits through the vents during normal operation.

Clearing time may take as long as 48 hours under dry weather conditions.

Examples of acceptable condensation are:

- The presence of a fine mist (no streaks, drip marks or large droplets).
- A fine mist covers less than 50% of the lens.

Examples of unacceptable condensation are:

- A water puddle inside the lamp.
- Streaks, drip marks or large droplets present on the interior of the lens.

If you see any unacceptable condensation, have your vehicle checked by an authorised dealer.

LIGHTING CONTROL

Lighting control positions

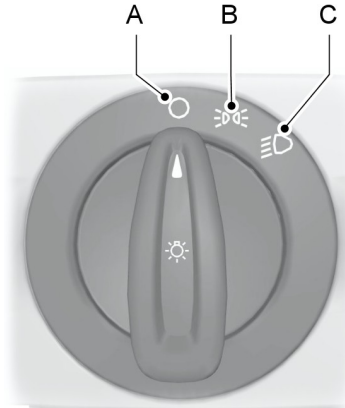

E70718

- A Off
- B Side and tail lamps
- C Headlamps

Parking lamps

CAUTION

- ⚠ Prolonged use of the parking lamps will discharge the battery.

Switch off the ignition.

Both sides

Set the lighting control to position **B**.

Lighting

One side

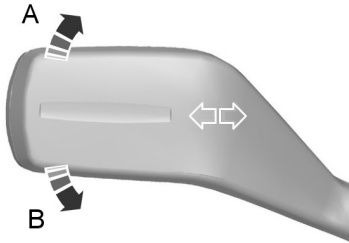

E75505

- A Right-hand side
- B Left-hand side

Main and dipped beam



E70725

Pull the lever fully towards the steering wheel to switch between main and dipped beam.

Headlamp flasher

Pull the lever slightly towards the steering wheel.

Home safe lighting

Switch the ignition off and pull the direction indicator lever towards the steering wheel to switch the headlamps on. You will hear a short tone. The headlamps will go off automatically after three minutes with any door open, or 30 seconds after the last door has been closed.

With all doors closed, but within the 30 second delay, opening any door will result in the three minute timer starting again.

The home safe lights can be cancelled by either pulling the direction indicator lever towards the steering wheel again or by turning the ignition switch on.

DAYTIME RUNNING LAMPS

The lamps will illuminate when the ignition is on.

AUTOLAMPS



E70719

Note: If you have switched autolamps on, you can only switch the main beam on when autolamps has switched the headlamps on.

The headlamps will come on and go off automatically depending on the ambient light.

AUTOMATIC MAIN BEAM CONTROL

WARNINGS



The system does not relieve you of your responsibility to drive with due care and attention. A manual override may be necessary if the system fails to switch the main beam on or off.

Lighting

WARNINGS



A manual override may be required when approaching other road users such as cyclists.



Do not use the system in fog.

CAUTIONS



In cold and severe weather conditions the system may not function. A manual override may be necessary in these cases.



Reflective road signs may be detected as oncoming traffic and the headlamps may be switched to dipped beam.



If the lights of oncoming vehicles are hidden by obstacles (for example guard rails) the system may not deactivate the main beam.



Always fit Ford Original Parts when replacing headlamp bulbs. Other bulbs may reduce system performance.



Check and replace wiper blades regularly to ensure the camera sensor has a clear view through the windscreen. Replacement wiper blades must be the correct length.

Note: *Keep the windscreen free from obstructions such as bird droppings, insects and snow or ice.*

The system will automatically switch on main beam if it is dark enough and no other traffic is present. If it detects an approaching vehicle's headlamps or tail lamps, or street lighting ahead the system will switch off main beam before it can distract other road users. Dipped beams will remain on.

A camera sensor is centrally mounted behind the windscreen of the vehicle, and monitors conditions continuously to decide when to switch the main beam off and on.

Once the system is active the main beam will switch on if:

- It is dark enough to require the use of main beams and
- there is no traffic or street lighting ahead and
- vehicle speed is greater than 40 km/h (25 mph).

The main beam will switch off if:

- The ambient light is high enough that main beam is not required.
- An approaching vehicle's headlamps or tail lamps are detected.
- Street lighting is detected.
- Vehicle speed falls below 25 km/h (16 mph).
- The camera sensor is too hot or becomes blocked.

Activating the system

Switch on the system using the information display and autolamps. See **Information Displays** (page 88). See **Autolamps** (page 55).



E70719

Turn the switch to the autolamps position.

Lighting

Note: The system may take a short time to initialise after first switching the ignition on, especially in very dark conditions. The main beam will not automatically switch on during this period.

Setting the system sensitivity

The system has three sensitivity levels which can be accessed via the information display. See **Information Displays** (page 88).

The sensitivity determines the speed at which the main beam will be restored after detected traffic leaves the field of view.

Manually overriding the system



E70725

Use the main beam lever to switch between main beam and dipped beam.

Note: This is a temporary override and the system will return to automatic operation after a short period.

To permanently deactivate the system use the information display menu or turn the lighting control switch from autolamps to headlamps.

FRONT FOG LAMPS



E70721

WARNING



Only use the front fog lamps when visibility is considerably restricted by fog, snow or rain.

REAR FOG LAMPS



E70720

WARNINGS



Only use the rear fog lamps when visibility is restricted to less than 50 metres (164 feet).



Do not use the rear fog lamps when it is raining or snowing and visibility is more than 50 metres (164 feet).

ADJUSTING THE HEADLAMPS - VEHICLES WITH: ADAPTIVE FRONT LIGHTING/XENON HEADLAMPS

To adjust the headlamps for driving on the left or right hand side of the road, see your dealer.

Lighting

HEADLAMP LEVELLING

Note: Vehicles with Xenon headlamps are equipped with automatic headlamp levelling.

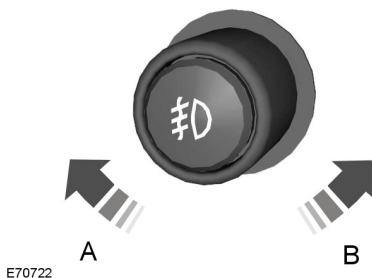

- A Raised headlamp beams
- B Lowered headlamp beams

You can adjust the level of the headlamp beams according to the vehicle load.

Recommended headlamp levelling switch positions

Load			Load in luggage compartment	Switch position
Front seats	Second row seats	Third row seats		
1-2	-	-	-	0
1-2	-	2	-	0 (0.5)**
1-2	3	-	-	1 (0.5)**
1-2	3	-	Max*	3 (0.5)**
1	-	-	Max*	4 (1.5)**

* See **Vehicle Identification Plate** (page 265).

** Vehicles with active suspension.

Lighting

ADAPTIVE HEADLAMPS

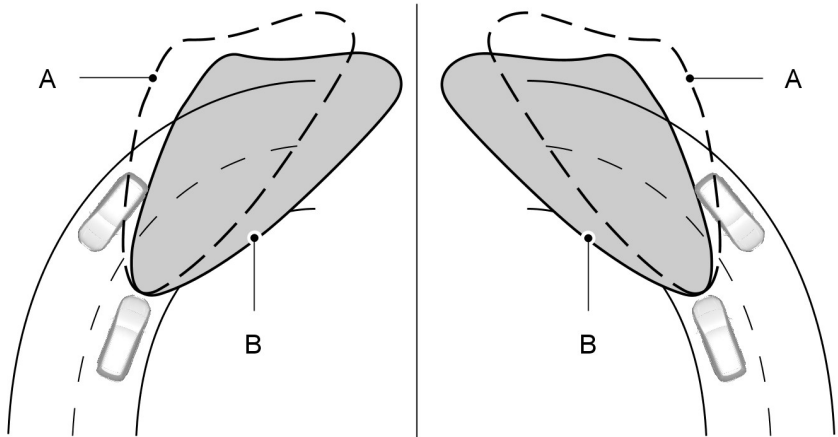

E72897

- A without AFS
- B with AFS

The AFS adjusts the headlamp dipped beam depending on vehicle direction and speed. It improves visibility when you are driving at night and helps to reduce headlamp glare for oncoming drivers.

The system will not operate when the vehicle is stationary, when you have switched on the daytime running lamps or when you have selected reverse gear.

A message will appear in the information display if the system malfunctions. See **Information Messages** (page 101). The headlamps will move to a fixed central or dipped position. Have the system checked as soon as possible.

Lighting

Cornering lamps

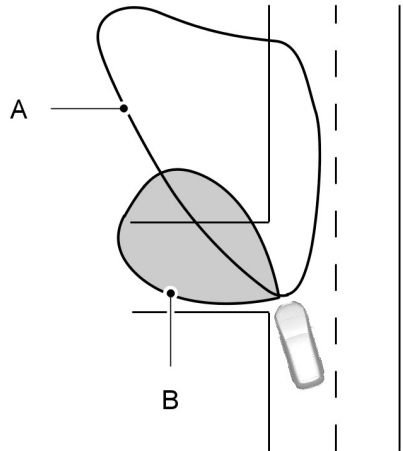
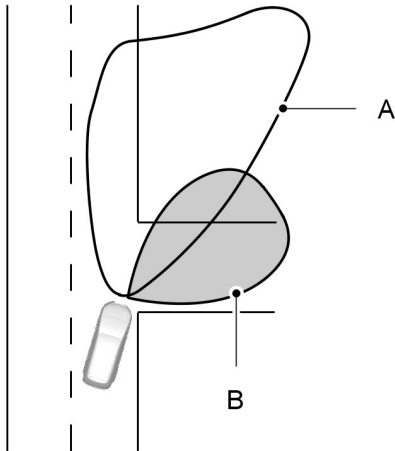

E72898

- A Headlamp beam
- B Cornering lamp beam

The cornering lamps illuminate the inside of a corner when you are turning.

HAZARD WARNING FLASHERS



For item location: See **At a Glance** (page 9).

DIRECTION INDICATORS

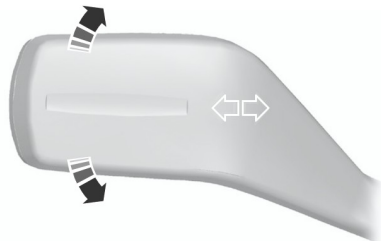

E70727

Note: Tap the lever up or down to make the direction indicators flash only three times.

Lighting

INTERIOR LAMPS

Courtesy lamp

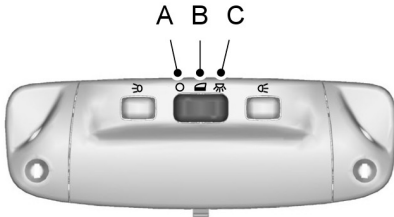

E71945

- A Off
- B Door contact
- C On

If you set the switch to position **B**, the courtesy lamp will come on when you unlock or open a door or the luggage compartment lid. If you leave a door open with the ignition switch off, the courtesy lamp will go off automatically after some time to prevent the vehicle battery from discharging. To switch it back on, switch on the ignition for a short time.

The courtesy lamp will also come on when you switch off the ignition. It will go off automatically after a short time or when you start or restart the engine.

If you set the switch to position **C** with the ignition switch off, the courtesy lamp will come on. It will go off automatically after a short time to prevent the vehicle battery from discharging. To switch it back on, switch on the ignition for a short time.

Reading lamps

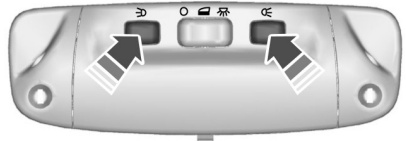

E71946

If you switch off the ignition, the reading lamps will go off automatically after some time to prevent the vehicle battery from discharging. To switch them back on, switch on the ignition for a short time.

LED Interior lighting

Note: Individual lamps may be switched on independently, but not off if all lamps have been switched on by the driver.

Note: All other lamps will be either non-switchable or with individual reading or dome lamp functionality only.

The lamps will come on when you unlock or open a door or the luggage compartment lid. If you leave a door open with the ignition switch off, all lamps will go off automatically after some time to prevent the vehicle battery from discharging. To switch them back on, switch on the ignition for a short time.

Lighting

Side mounted lamp

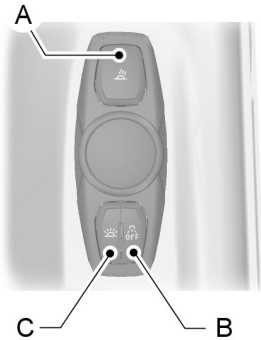

E139419

- A Reading lamp on and off switch
- B Door function switch
- C All lamps on and off switch

If you press switch **B** all lamps remain off when the door is opened. Press the switch again to reverse.

You can control all lamps using switch **C**.

Centre mounted lamp

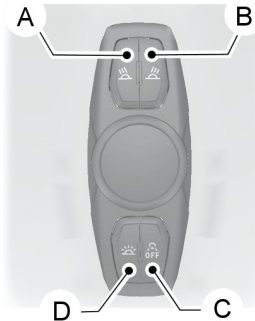

E139420

- A Right-hand side reading lamp on and off switch
- B Left-hand side reading lamp on and off switch
- C Door function switch
- D All lamps on and off switch

If you press switch **C** all lamps remain off when the door is opened. Press the switch again to reverse.

You can control all lamps using switch **D**.

Lighting

Vanity mirror lamps

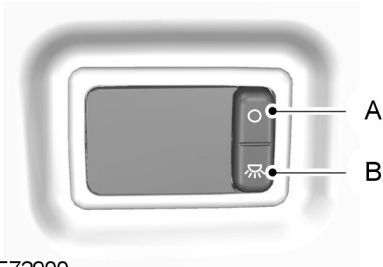

E72900

- A Off
- B On

If you switch off the ignition, the vanity mirror lamps will go off automatically after a short time to prevent the vehicle battery from discharging. To switch them back on, switch on the ignition for a short time.

REMOVING A HEADLAMP

WARNING



Have Xenon bulbs changed by a properly trained technician. There is a risk of electric shock.

1. Open the bonnet. See **Opening and Closing the Bonnet** (page 233).

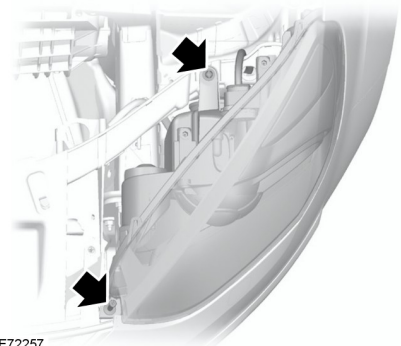

E72257

Note: When you remove the headlamp, make sure that the front screw remains in the headlamp moulding.

2. Remove the screws.

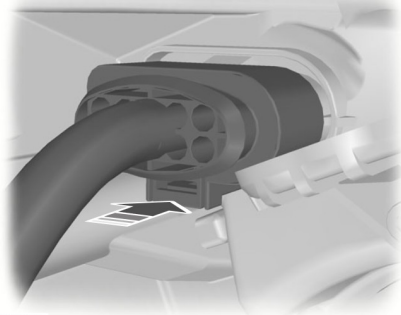

E88875

3. Disconnect the electrical connector.
4. Pull the headlamp as far as possible towards the centre of the vehicle and disengage it from the lower fixing point.
5. Lift the outer side of the headlamp and remove it.

Note: When fitting the headlamp, make sure that you reconnect the electrical connector properly.

Lighting

Note: When fitting the headlamp, make sure that you fully engage the headlamp in the lower fixing point.

Note: When fitting the headlamp, make sure that the front screw is located in the headlamp moulding before you install it.

Note: When fitting the headlamp, tighten the front screw first and then the rear screw.

CHANGING A BULB

WARNINGS



Switch the lights and the ignition off.



Let the bulb cool down before removing it.



Have Xenon bulbs changed by a properly trained technician. There is a risk of electric shock.

CAUTIONS



Do not touch the glass of the bulb.



Only fit bulbs of the correct specification. See **Bulb Specification Chart** (page 72).

Note: The following instructions describe how to remove the bulbs. Fit replacements in the reverse order unless otherwise stated.

Headlamp

Note: Remove the covers to gain access to the bulbs.

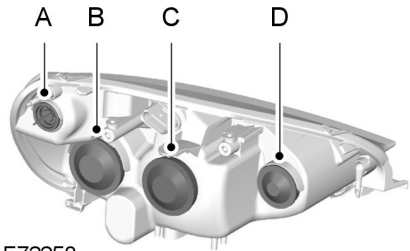

E72258

- A Direction indicator
- B Headlamp main beam
- C Headlamp dipped beam
- D Cornering lamp

Direction indicator

1. Remove the headlamp. See **Removing a Headlamp** (page 63).

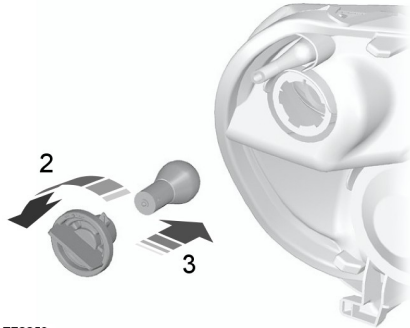

E72259

2. Turn the bulb holder anti-clockwise and remove it.
3. Gently press the bulb into the bulb holder, turn it anti-clockwise and remove it.

Lighting

Headlamp main beam

1. Remove the headlamp. See **Removing a Headlamp** (page 63).

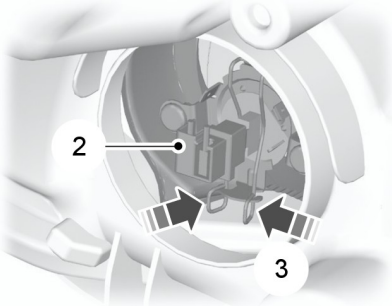

E72261

2. Disconnect the electrical connector.
3. Release the clip and remove the bulb.

Headlamp dipped beam

1. Remove the headlamp. See **Removing a Headlamp** (page 63).

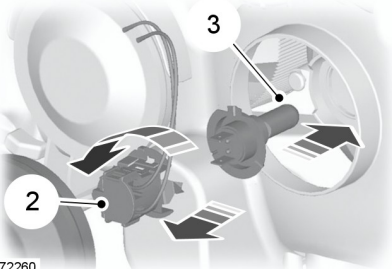

E72260

2. Turn the bulb holder anti-clockwise and remove it.
3. Remove the bulb.

Cornering lamp

1. Remove the headlamp. See **Removing a Headlamp** (page 63).

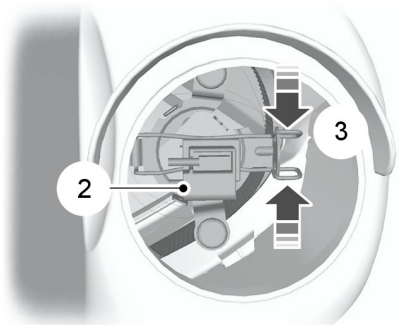

E72262

2. Disconnect the electrical connector.
3. Release the clip and remove the bulb.

Daytime running lamps

Note: *These are not serviceable items, please consult your dealer if they fail.*



E126170

Lighting

Side repeater

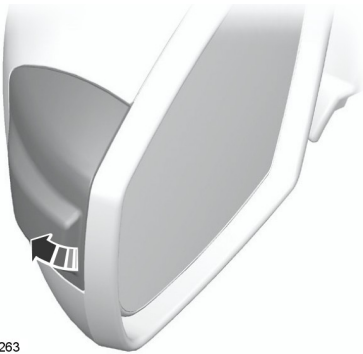

E72263

1. Carefully remove the side repeater.

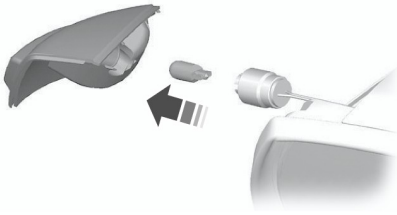

E72291

2. Remove the bulb holder.
3. Remove the bulb.

Approach lamp

Note: Position the mirror glass as far inwards as possible.



E72264

1. Insert a screwdriver into the gap between the mirror housing and the mirror glass and release the metal retaining clip.

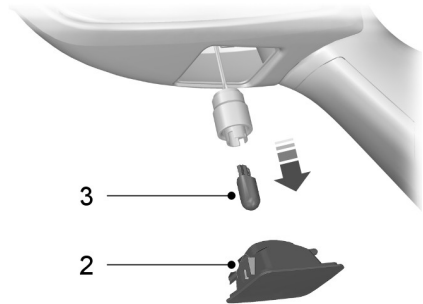

E72265

2. Remove the lamp.
3. Remove the bulb.

Front fog lamp and side lamp (S-MAX)

1. Remove the headlamp to access the fog lamp. See **Removing a Headlamp** (page 63).

Lighting

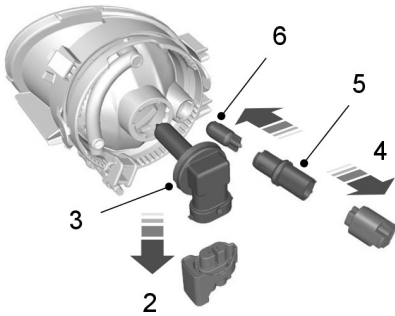

E126440

2. Disconnect the electrical connector.

Note: You cannot separate the fog lamp bulb from the bulb holder.

3. Turn the fog lamp bulb holder anti-clockwise and remove it.

4. Disconnect the electrical connector.

5. Turn the side lamp bulb holder anti-clockwise and remove it.

6. Remove the side lamp bulb.

Front fog lamp and side lamp (Galaxy)

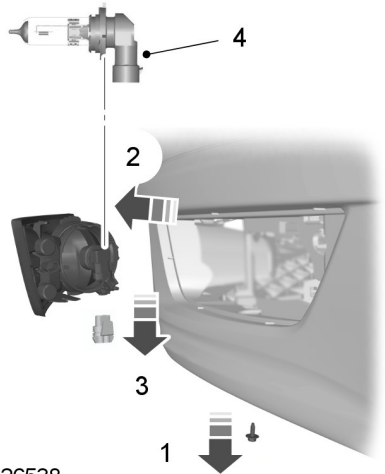

E126538

1. Remove the screw.

2. Remove the lamp.

3. Disconnect the fog lamp electrical connector.

Note: You cannot separate the fog lamp bulb from the bulb holder.

4. Turn the fog lamp bulb holder anti-clockwise and remove it.

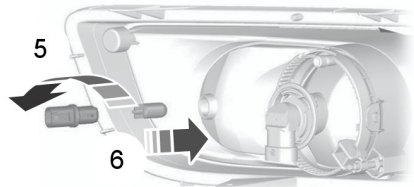

E72269

5. Turn the side lamp bulb holder anti-clockwise and remove it.

6. Remove the side lamp bulb.

Lighting

Rear lamps (S-MAX)

Direction indicator, tail and brake lamp

Note: These are not serviceable items, please consult your dealer if they fail.



E126274

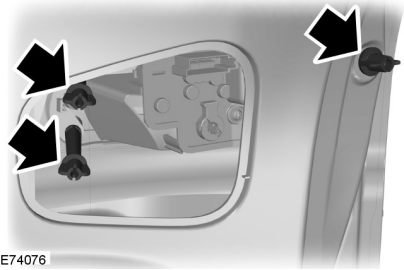

E74076

2. Remove the wing nuts.
3. Remove the lamp.
4. Disconnect the electrical connector.

Reversing lamp, tail lamp and fog lamp



E72271

1. Remove the trim panel.

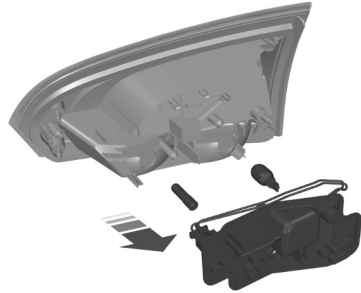

E126303

5. Remove the screws.
6. Remove the bulb holder.
7. Gently press the bulb into the bulb holder, turn it anti-clockwise and remove it.

Lighting

Rear lamp (Galaxy)

Direction indicator, tail and brake lamp

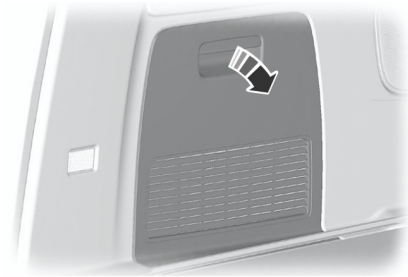

E75380

1. Remove the trim panel.

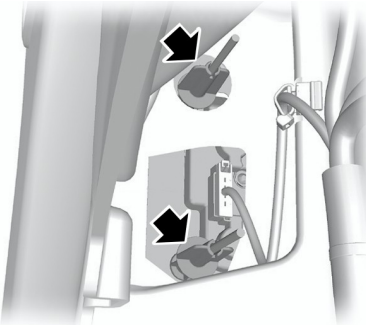

E72791

2. Remove the wing nuts.

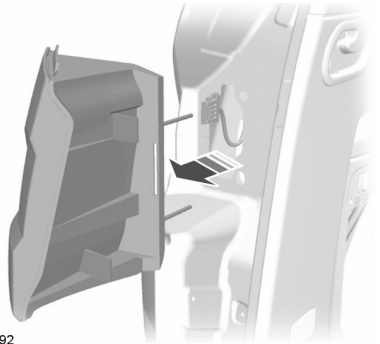

E72792

3. Remove the lamp.
4. Disconnect the electrical connector.



E72793

Note: On some vehicles the tail lamps are LED. These are not serviceable items, please consult your dealer if they fail.

5. Remove the screw.
6. Remove the bulb holder.
7. Gently press the bulb into the bulb holder, turn it anti-clockwise and remove it.

Lighting

Reversing lamp, tail lamp and fog lamp

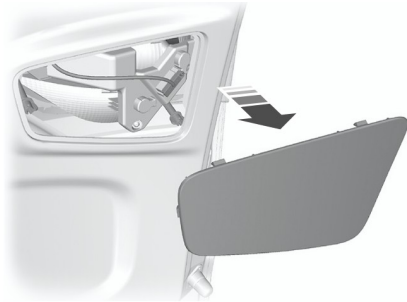

E72794

1. Remove the trim panel.

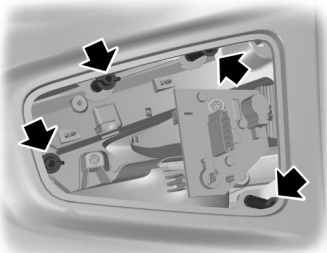

E72795

2. Remove the wing nuts.
3. Remove the lamp.
4. Disconnect the electrical connector.

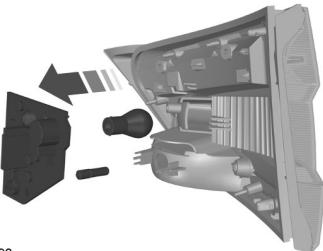

E126393

5. Remove the screw.

6. Remove the bulb holder.
7. Gently press the bulb into the bulb holder, turn it anti-clockwise and remove it.

Central high mounted brake lamp

Note: These are not serviceable items, please consult your dealer if they fail.

Number plate lamp

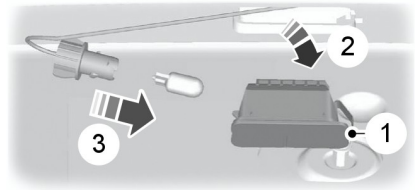

E72789

1. Carefully release the spring clip.
2. Remove the lamp.
3. Turn the bulb anti-clockwise and remove it.

Interior lamps

Vehicles with LED lamps

Note: These are not serviceable items, please consult your dealer if they fail.

Lighting

Vehicles without interior sensors

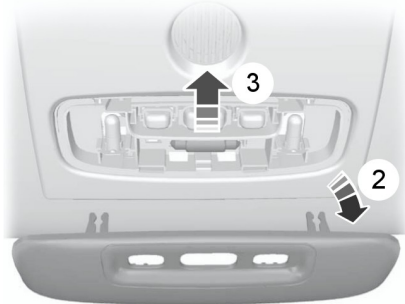

E72788

1. Carefully prise out the lens.
2. Remove the lens.
3. Remove the bulb.

Vehicles with interior sensors

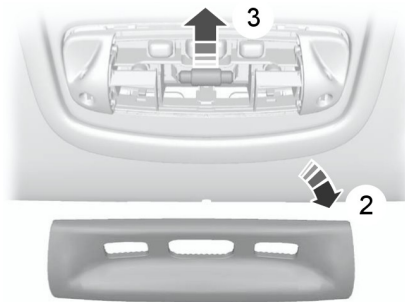

E72787

1. Carefully prise out the lens.
2. Remove the lens.
3. Remove the bulb.

Reading lamps

Vehicles without interior sensors

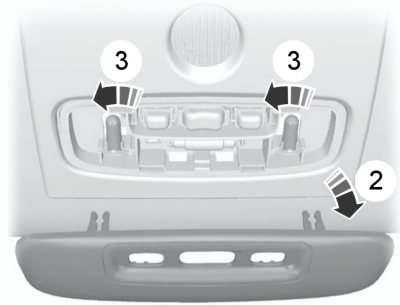

E72796

1. Carefully prise out the lens.
2. Remove the lens.
3. Remove the bulb.

Vehicles with interior sensors

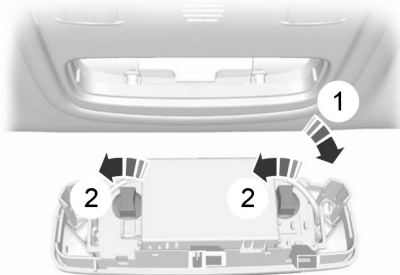

E72786

1. Carefully prise out the lamp.
2. Turn the bulb holder anti-clockwise and remove it.

Lighting

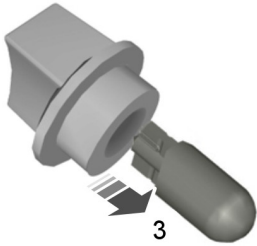

E73939

3. Remove the bulb.

Vanity mirror lamp

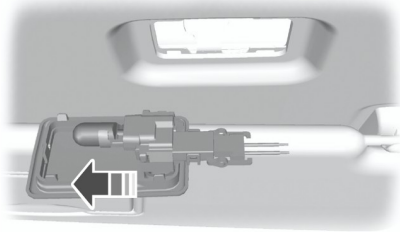

E72785

1. Carefully prise out the lamp.
2. Remove the bulb.

Luggage compartment lamp and tailgate lamp

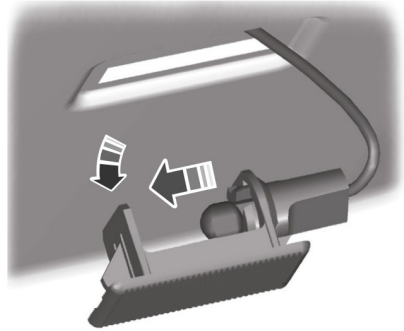

E72784

1. Carefully prise out the lamp.
2. Remove the bulb.

BULB SPECIFICATION CHART

Lamp	Specification	Power (watt)
Front direction indicator	PY21W	21
Headlamp main beam	H1	55
Headlamp dipped beam	H7	55
Cornering lamp	H1	55
Side repeater	W5W	5
Approach lamp	W5W	5
Front fog lamp (S-MAX)	H8	35
Front fog lamp (Galaxy)	HB4	55

Lighting

Lamp	Specification	Power (watt)
Side lamp	W5W	5
Rear direction indicator	PY21W	21
Rear fog lamp	P21W	21
Reversing lamp	P21W	21
Number plate lamp	W5W	5
Interior lamp	Festoon	10
Reading lamp	BA9s	5
Vanity mirror lamp	W5W	5
Luggage compartment lamp	W6W	6

Windows and Mirrors

POWER WINDOWS

WARNING

 Do not operate the electric windows unless they are free from obstruction.

Note: If you operate the switches often during a short period of time, the system might become inoperable for a certain time to prevent damage due to overheating.

Note: You can operate the windows for several minutes after you switch off the ignition. They will be deactivated as soon as a door is opened.

Note: If you operate both the switch on the relevant door and the switch for that window on the driver's door at the same time, the window will stop moving.

Switch on the ignition to operate the electric windows.

Global opening and global closing

You can also operate the electric windows with the ignition off via the global opening and global closing function. See **Global Opening and Closing** (page 39).

Note: Global opening and global closing will open or close the windows automatically only on vehicles equipped with four electric windows.

Note: Global closing will only operate if you have set the memory correctly for each window.

Driver's door switches



E121510

You can operate all the windows with the switches on the door trim panel of the driver's door.

Front and rear passengers' door switches

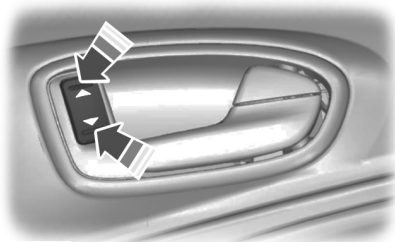

E70849

Opening and closing the windows automatically

Press or lift the switch to the second action point and release it. Press or lift it again to stop the windows.

Windows and Mirrors

Safety switch for rear windows

WARNING



On some vehicles, pressing the switch will also lock the rear doors from inside. See **Child Safety Locks** (page 27).

Locks (page 27).

Note: You can always operate the rear windows from the driver's door.



E121511

A switch in the driver's door disables the rear electric window switches.

The light in the switch illuminates and the lights in the rear window switches go off when the rear windows are disabled.

Anti-trap function

WARNING



Careless closing of the windows can override the protection function and cause injuries.

The electric windows will stop automatically while closing and reverse some distance if there is an obstacle in the way.

Overriding the anti-trap function

CAUTION



While you close the window for the third time, the anti-trap function is disabled. Make sure there are no obstacles in the way of the closing window.

To override this protection function when there is a resistance, for example, in the winter, proceed as follows:

1. Close the window twice until it reaches the resistance and let it reverse.
2. Close the window a third time to the resistance. The anti-trap function is disabled and you cannot close the window automatically. The window will override the resistance and you can close it fully.
3. If the window does not close after the third attempt, have it checked by a properly trained technician.

Resetting the memory of the electric windows

WARNING



The anti-trap function is deactivated until you have reset the memory.

After the battery has been disconnected from the vehicle you must reset the memory separately for each window:

1. Lift the switch until the window is fully closed. Hold the switch lifted for one more second.
2. Release the switch and lift it again, two or three times, for one more second.
3. Open the window and try to close it automatically.
4. Reset and repeat procedure if the window does not close automatically.

Windows and Mirrors

Safety mode

WARNING



The anti-trap function is not active during this procedure.

If the system detects a malfunction, it enters a safety mode. The windows will move for only about 0.5 seconds at a time and then stop again. Close the windows by pressing the switch again when the windows stop moving. Have this checked immediately.

EXTERIOR MIRRORS

WARNING



Do not overestimate the distance of the objects that you see in the convex mirror. Objects seen in convex mirrors will appear smaller and further away than they actually are.

Manual folding mirrors

Folding

Push the mirror towards the door window glass.

Unfolding

Make sure that you fully engage the mirror in its support when returning it to its original position.

ELECTRIC EXTERIOR MIRRORS

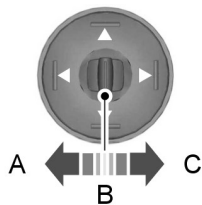

E70846

- A Left-hand mirror
- B Off
- C Right-hand mirror

Mirror tilting positions

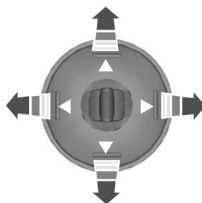

E70847

The electric exterior mirrors are fitted with a heating element that will defrost or demist the mirror glass. See **Heated Windows and Mirrors** (page 119).

Electric folding mirrors

Automatic folding and unfolding

Note: If the mirrors have been folded using the manual fold button they can only be unfolded using the manual fold button.

Windows and Mirrors

The mirrors will fold automatically when you lock the vehicle with the key, the remote control or a keyless entry system request. The mirrors will unfold when you unlock the vehicle with the key, the remote control, a keyless entry system request, the driver's interior door handle or starting the engine.

Manual folding and unfolding

The electric folding mirrors operate with the ignition on.

Note: You can operate the mirrors (mirror tilting and folding) for several minutes after you switch off the ignition. They will be deactivated as soon as a door is opened.



E72623

Press the button to fold or unfold the mirrors.

If you press the switch again while the mirrors are moving, they will stop and reverse the direction of movement.

Note: When the mirrors are operated often during a short period of time, the system may become inoperable for a period of time to prevent damage due to overheating.

Reverse mirror dipping

Depending on the switch position (**A** or **C**), the relevant exterior mirror will dip whenever you select reverse gear, giving you a view of the kerb.

Note: You can disable this feature by leaving the switch in position **B**.

The exterior mirror will return to the original position:

- If the vehicle speed exceeds 10 km/h (6 mph).
- Approximately 10 seconds after reverse gear has been disengaged.
- If the switch is returned to position **B**.

When you first use this feature, the mirror will dip to a preset position. This position can be adjusted using the following sequence:

1. Turn the ignition on. Do not start the engine.
2. Select the desired exterior mirror (**A** or **C**).
3. Select reverse gear, the selected exterior mirror will adjust to a preset position.
4. Adjust the mirror to the required dipped position.
5. Disengage reverse gear or press and hold the desired memory pre-set button until a single chime sounds to confirm. See **Memory Function** (page 141).

The settings will be stored automatically.

Windows and Mirrors

AUTO-DIMMING MIRROR

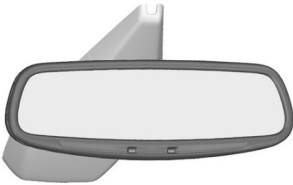

E71028

The auto-dimming mirror will adjust automatically when hit by glaring light from behind. It will not work when you have selected reverse gear.

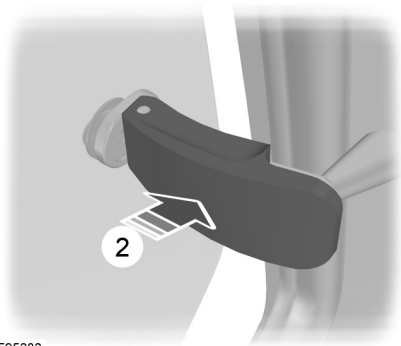

E95383

Closing

REAR QUARTER WINDOWS

Manual rear quarter windows

Opening

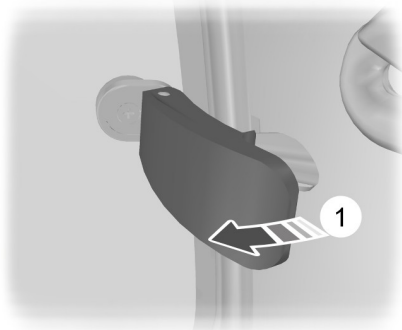

E72126

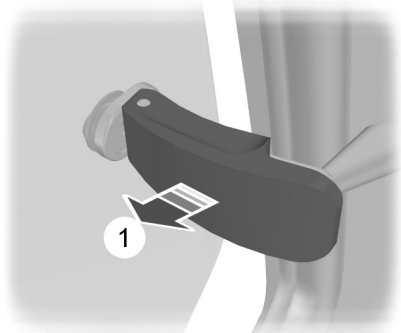

E95384

Windows and Mirrors

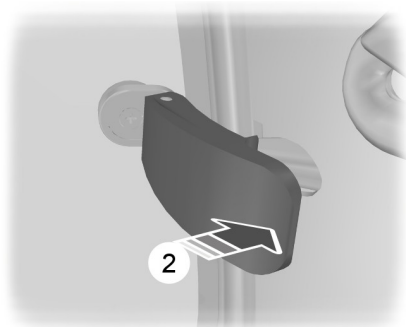

E95385

Note: Make sure that the lever is securely engaged in its catch.

Electric rear quarter windows

Switch on the ignition to operate the rear quarter windows.

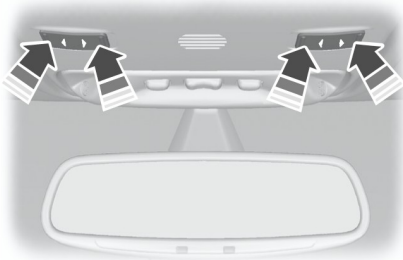



E72127

BLIND SPOT MONITOR

Blind spot information system (BLIS)

WARNINGS

 The system is not designed to prevent contact with other vehicles or objects. The system only provides a warning to assist you in detecting vehicles in the blind spot zones. The system will not detect obstacles, pedestrians, motorcyclists or cyclists.

 Do not use the system as a replacement for using the side and rear view mirrors, and looking over your shoulder before changing lanes. The system is not a replacement for careful driving and is only to be used as an aid.

The system is a convenience feature that aids the driver in detecting vehicles that may have entered the blind spot zone (▲). The detection area is on both sides of the vehicle extending rearwards from the exterior mirrors to approximately 3 metres (10 feet) beyond the bumper. The system will alert you if certain vehicles enter the blind spot zone whilst driving.

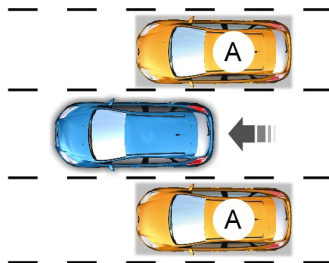

E124788

Using the system

The system displays a yellow indicator located in the exterior mirrors.

Windows and Mirrors



E124736

Note: Both indicators will illuminate briefly when you switch the ignition on to confirm that the system is operational.

Note: On vehicles with automatic transmission, the system is active only in **S**, **D** and **N**.

The system is only active when you exceed 10 km/h (6 mph). The system is temporarily deactivated when you select reverse gear.

System detection and alerts

The system will trigger the alert for vehicles that enter the blind spot zone from the rear or merge from the side. Vehicles that you pass, or vehicles that enter the blind spot zone from the front, will only trigger the alert after the vehicle has remained in the blind spot zone for a short period of time.

Note: Vehicles that pass through the blind zone quickly (typically less than 2 seconds) will not trigger the alert.

The system consists of two radar sensors each located behind the rear wheels hidden behind the bumpers.

CAUTIONS



Do not place items such as bumper stickers in this area.



Repairs to these areas using body filler will affect the performance of the system.

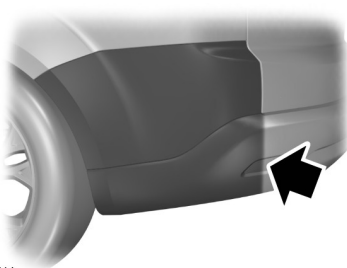

E124741

Detection limitations

There may be certain instances where vehicles entering and exiting the blind spot zones may not be detected.

Instances which may cause non-detection:

- Debris build up on the rear bumper panels in the area of the sensors.
- Certain manoeuvring of vehicles entering and exiting the blind zone.
- Vehicles passing through the blind zone at high speed.
- Severe weather conditions.
- Several vehicles passing through the blind zone following each other closely.

False alerts

Note: False alerts are temporary and will self correct.

There may be certain instances when the system will alert with no vehicle present in the blind zone.

Circumstances where false alerts may occur:

- Road guardrails.
- Motorway concrete walls.
- Construction areas.
- Sharp turns around a building.
- Bushes and trees.

Windows and Mirrors

- Cyclists and motorcyclists.
- Coming to a stop with a vehicle directly behind but very close.

Turning the system on and off

Note: *The on or off position will remain until manually changed.*

You can turn the system on and off using the information display. See **Information Displays** (page 88).

When you turn the system off no further alerts will be received. The BLIS warning indicator will illuminate. See **Warning Lamps and Indicators** (page 84).

Detection errors

Note: *The alert indicator in the mirror will not illuminate.*

If the system senses a fault on either sensor, the system warning symbol will illuminate and remain on. The information display will confirm the fault and indicate whether the left or right side is affected.

Blocked sensor

WARNING



Prior to the system recognizing a blocked condition and issuing a warning, the number of missed objects will increase.

CAUTION



The sensors may not detect vehicles in heavy rain or other conditions that cause disruptive reflections.

Note: *Keep the rear bumper area surrounding the sensors free from dirt, ice and snow.*

If a sensor becomes blocked the system performance may degrade. A blocked sensor message may be displayed.

The system will automatically return to normal operation once two other vehicles have been detected on both sides.

Trailer towing false alerts

CAUTION



Vehicles fitted with a trailer tow module not approved by us may not correctly be detected. Switch the system off to avoid false alerts. See **Information Displays** (page 88).

If the vehicle is fitted with a trailer tow module approved by us, the system will detect a connected trailer and deactivate. A confirmation message will be shown in the information display. See **Information Messages** (page 101). The BLIS warning indicator will illuminate. See **Warning Lamps and Indicators** (page 84).

Instrument Cluster

GAUGES

Type 1 and 2

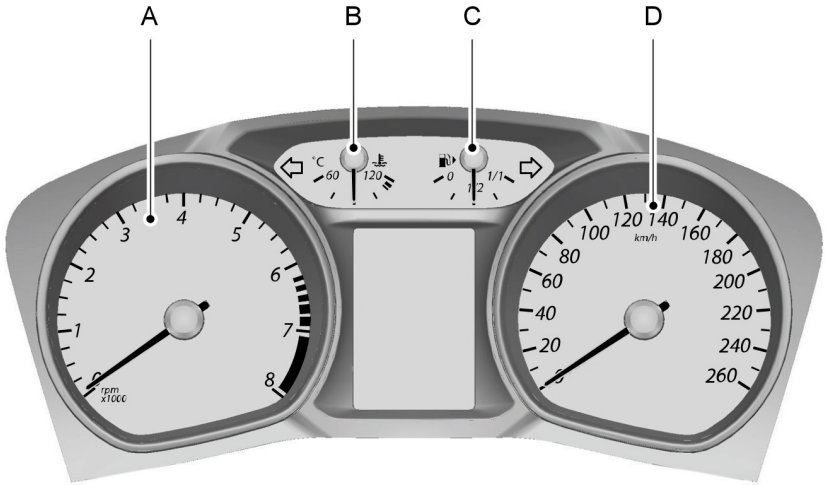

E72984

- A Tachometer
- B Engine coolant temperature gauge
- C Fuel gauge
- D Speedometer

Instrument Cluster

Type 3

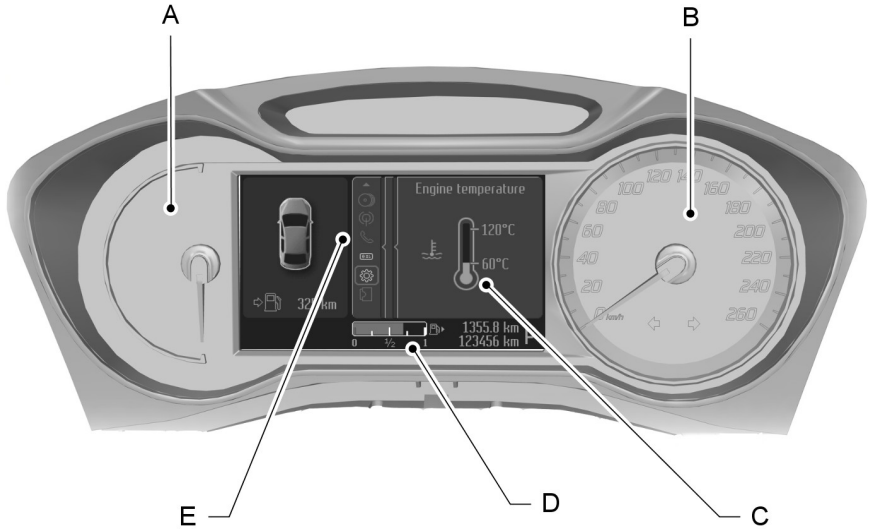

E130765

- A Tachometer
- B Speedometer
- C Engine coolant temperature gauge
- D Fuel gauge
- E Message centre. See **Information Displays** (page 88).

Engine coolant temperature gauge

Note: On type 3 this gauge is shown within the message centre and will not be displayed unless required. See **Information Displays** (page 88).

Shows the temperature of the engine coolant. At normal operating temperature, the indicator will remain in the centre section.

CAUTION

! Do not restart the engine until the cause of overheating has been resolved.

If the indicator moves towards 120°C, the engine is overheating. Stop the engine, switch the ignition off and determine the cause **once the engine has cooled down**. See **Engine Coolant Check** (page 244).

Instrument Cluster

Fuel gauge

Note: On type 3 this gauge is shown within the message centre.

The arrow adjacent to the fuel pump symbol tells you on which side of your vehicle the fuel filler cap is located.

WARNING LAMPS AND INDICATORS

The following warning lamps and indicators will illuminate briefly when you switch the ignition on to confirm that the system is operational:

- ABS
- Airbag
- Blind spot monitor
- Brake system
- Coolant temperature
- Electric parking brake (EPB)
- Engine
- Frost
- Ignition
- Oil pressure
- Stability control (ESP)

If a warning or indicator lamp does not illuminate when the ignition is switched on, this indicates a malfunction. Have the system checked by properly trained technician.

ABS warning lamp



If it illuminates when you are driving, this indicates a malfunction. You will continue to have normal braking (without ABS). Have the system checked by a properly trained technician as soon as possible.

Airbag warning lamp



If it illuminates when you are driving, this indicates a malfunction. Have the system checked by a properly trained technician.

Blind spot monitor indicator



It will illuminate when this feature is switched off or in conjunction with a message. See **Blind Spot Monitor** (page 79). See **Information Messages** (page 101).

Brake system lamp



It illuminates when the parking brake is engaged.

WARNING



Reduce your speed gradually and stop your vehicle as soon as it is safe to do so. Use your brakes with care.

If it illuminates when you are driving, check that the parking brake is not engaged. If the parking brake is not engaged, this indicates a malfunction. Have the system checked by a properly trained technician immediately.

Coolant temperature warning lamp

CAUTION



Do not resume your journey if it illuminates despite the level being correct. Have the system checked by a properly trained technician immediately.

Instrument Cluster



If it stays on after starting or illuminates when driving, this indicates a malfunction. Stop your vehicle as soon as it is safe to do so and switch the engine off. Check the coolant level. See **Engine Coolant Check** (page 244).

Direction indicators



Flashes during operation. A sudden increase in the rate of flashing warns of a failed indicator bulb. See **Changing a Bulb** (page 64).

Engine warning lamp



If it illuminates with the engine running, this indicates a malfunction. If it flashes when you are driving, **reduce the speed of your vehicle immediately**. If it continues to flash, avoid heavy acceleration or deceleration. Have the system checked by a properly trained technician immediately.

CAUTION



If the engine warning lamp illuminates in conjunction with a message, have the system checked as soon as possible.

Electric parking brake (EPB) warning lamp



It will illuminate when an EPB warning message is displayed in the information display. See **Electric Parking Brake** (page 166).

Forward alert indicator



It will illuminate when this feature is switched off. See **Forward alert function** (page 186).

Front fog lamp indicator



It will illuminate when you switch the front fog lamps on.

Frost warning lamp

WARNING



Even if the temperature rises to above 4°C (39.2°F) there is no guarantee that the road is free of hazards caused by inclement weather.



It will illuminate and glow amber when the outside air temperature is between 4°C (39.2°F) and 0°C (32°F). It will glow red when the temperature is below 0°C (32°F).

Glow plug indicator



See **Starting a Diesel Engine** (page 148).

Headlamp indicator



It will illuminate when you switch the headlamp dipped beam or the side and tail lamps on.

Ignition warning lamp



If it illuminates when you are driving, this indicates a malfunction. Switch off all unnecessary electrical equipment. Have the system checked by a properly trained technician immediately.

Instrument Cluster

Lane departure warning indicator



It will illuminate when this feature is switched off or in conjunction with a message. The indicator will go out when you switch the system back on or when you switch the ignition off. See **Lane Departure Warning** (page 191). See **Information Messages** (page 101).

Low fuel level warning lamp



If it illuminates, refuel as soon as possible.

Main beam indicator



It will illuminate when you switch the headlamp main beam on. It will flash when you use the headlamp flasher.

Message indicator



It will illuminate when a new message is stored in the information display. See **Information Messages** (page 101).

Oil pressure warning lamp

CAUTION



Do not resume your journey if the oil pressure warning lamp illuminates despite the oil level being correct. Have the system checked by a properly trained technician immediately.



If the lamp stays on after starting or illuminates during a journey, this indicates a malfunction. Stop your vehicle as soon as it is safe to do so and switch the engine off. Check the engine oil level. See **Engine Oil Check** (page 244).

Rear fog lamp indicator



It will illuminate when you switch the rear fog lamps on.

Seat belt reminder



See **Seat belt reminder** (page 31).

Shift indicator



It will illuminate to inform you that shifting to a higher gear may give better fuel economy and lower CO2 emissions. It will not illuminate during periods of high acceleration, braking or when the clutch pedal is pressed.

Stability control (ESP) warning lamp



While driving, it flashes during activation of the system. After switching on the ignition, if it does not illuminate or illuminates continuously while driving, this indicates a malfunction. During a malfunction, the system switches off. Have the system checked by a properly trained technician as soon as possible.

If you switch ESP off, the warning lamp will illuminate. The lamp will go out when you switch the system back on or when you switch the ignition off.

Start-stop indicator



It will illuminate to inform you when the engine shuts down or in conjunction with a message. See **Using start-stop** (page 151). See **Information Messages** (page 101).

Instrument Cluster

AUDIBLE WARNINGS AND INDICATORS

Switching the chimes on and off

You can deactivate certain chimes.

To set which chimes should sound:



E70499

1. Press the right arrow button on the steering wheel to enter the main menu.
2. Highlight **Setup** with the up and down arrow buttons and press the right arrow button.
3. Highlight **Chimes** and press the right arrow button.
4. Highlight the chime and press the **OK** button to switch the chime on and off.
5. Press the left arrow button to exit the menu. Press and hold the left arrow button to return to the main menu display.

Information Displays

GENERAL INFORMATION

WARNING



Do not operate the information display controls when the vehicle is moving.

Note: *The information display will remain on for several minutes after you switch off the ignition.*

Various systems on your vehicle can be controlled using the buttons on your steering wheel. Corresponding information is displayed in the information display.

For detailed instructions on audio, navigation, phone etc. refer to the appropriate manual.

Controls



E70499

Instrument cluster functions

Function	Type 1	Type 2	Type 3
Trip computer	X	X	X
Information messages	X	X	X
Clock setup	X	X	X
Display settings	-	X	X
Park heater setup	-	X	X

Press the **up** and **down** arrow buttons:

- to scroll through the trip computer displays
- to scroll through and highlight the options within a menu.

Press the **right** arrow button:

- to enter the main menu from the trip computer displays
- to enter a sub-menu.

Press the **left** arrow button to exit a menu.

Hold the **left** arrow button pressed at any time to return to the main menu display (escape button).

Note: *The system will return to the trip computer displays automatically if you do not press any button for a period of time.*

Press the **OK** button to choose and confirm a setting.

Information Displays

Function	Type 1	Type 2	Type 3
Navigation control	-	-	X
CD control	-	-	X
CD changer control	-	-	X
Radio control	-	-	X
Phone control	-	-	X
Auxiliary input control	-	-	X

Type 1



Press the **up** and **down** arrow buttons on the steering wheel to scroll through the trip computer displays. See **Trip Computer** (page 97).

E80604

Information Displays

Menu structure

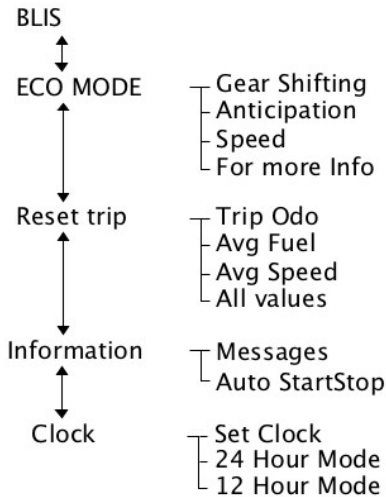

E131626

Type 2

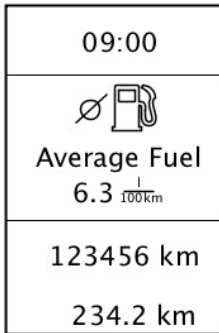

E74426

Press the **up** and **down** arrow buttons on the steering wheel to scroll through the trip computer displays. See **Trip Computer** (page 97).

Information Displays

Menu structure

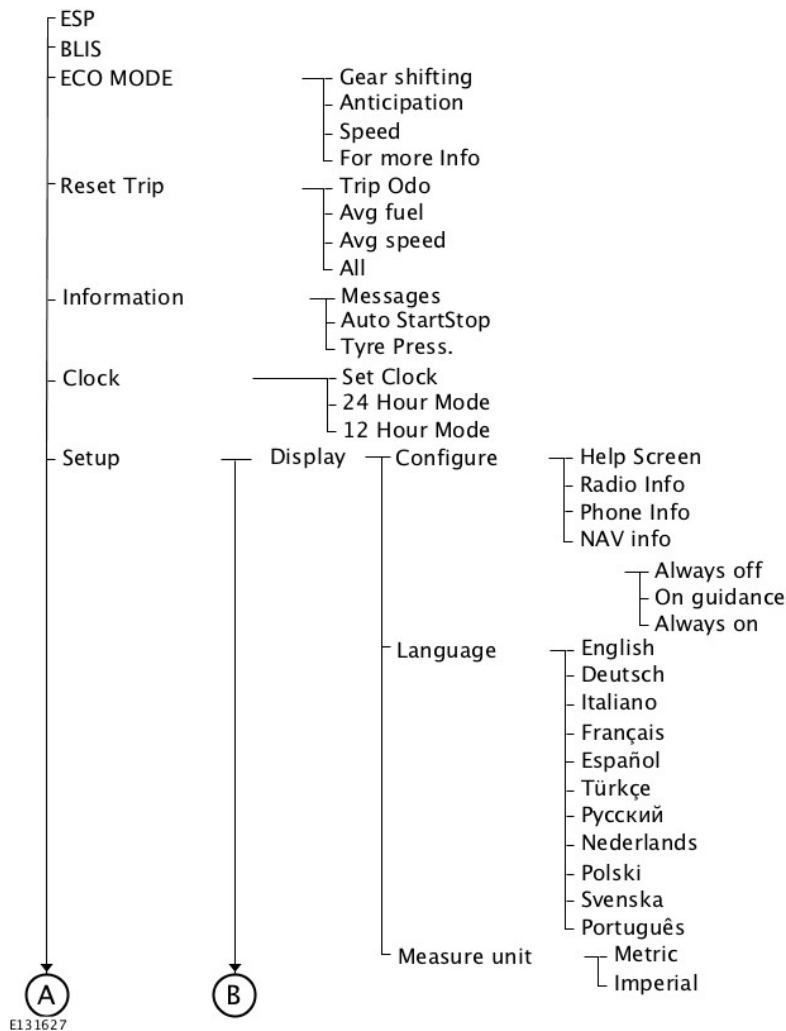

Information Displays

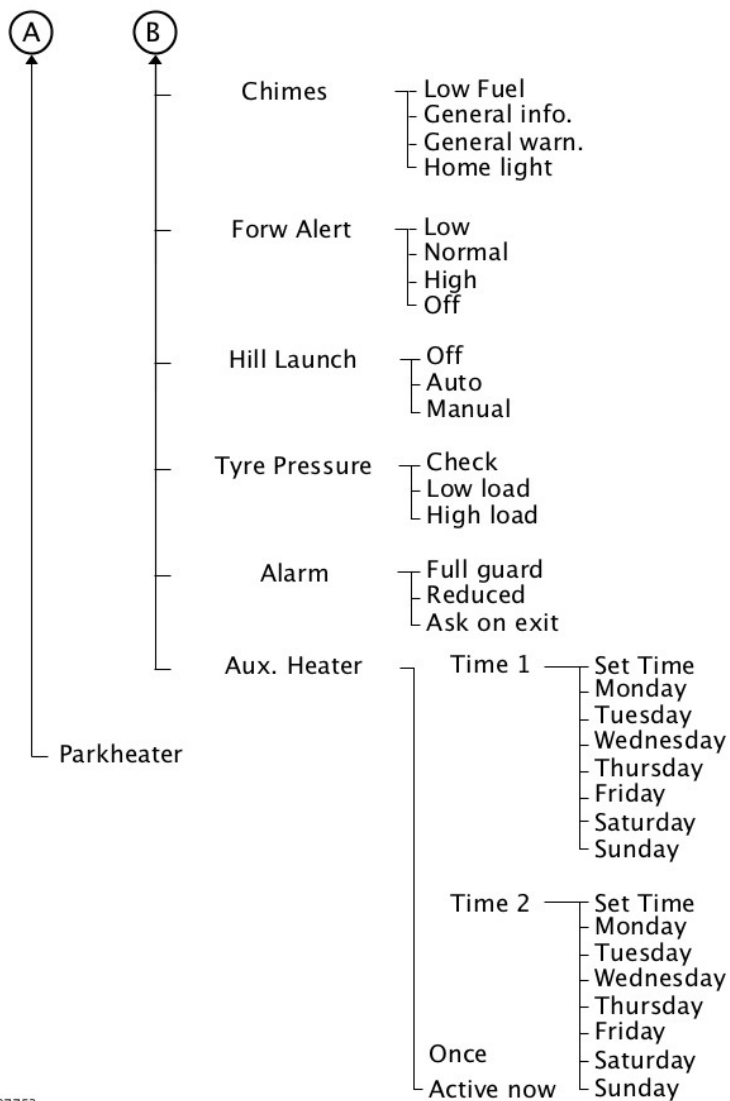

E87753

Information Displays

Type 3

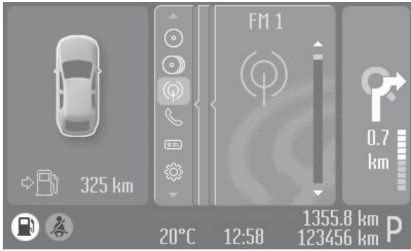

E88048

Use the controls to scroll through the menu displays.

Device list

The highlighted icon shows the current menu in use.



Navigation



CD



CD changer



Radio



Phone



Trip computer



Settings



Auxiliary input

Information Displays

Menu structure

Navigation



CD



CD changer



Radio



Phone



Trip computer



- Home
- Destinat. mem. – Destinations
- Destinat. A-Z – Destinations
- Last destinat. – Destinations
- Cancel guidan.

– Folder / Tracks

- CD 1 – Folder / Tracks
- CD 2 – Folder / Tracks
- CD 3 – Folder / Tracks
- CD 4 – Folder / Tracks
- CD 5 – Folder / Tracks
- CD 6 – Folder / Tracks

- Station list – Stations
- FM 1 / FM – Stations
- FM 2 – Stations
- FM 3 – Stations
- FM – AST – Stations
- MW / AM – Stations
- LW / AM-AST – Stations

- Phone book – Numbers
- Redial
- Incoming calls – Numbers
- Outgoing calls – Numbers
- Call status

- Distance to empty
- Average fuel
- Average speed
- Reset selected element
- Reset trip odometer

E131628

Information Displays

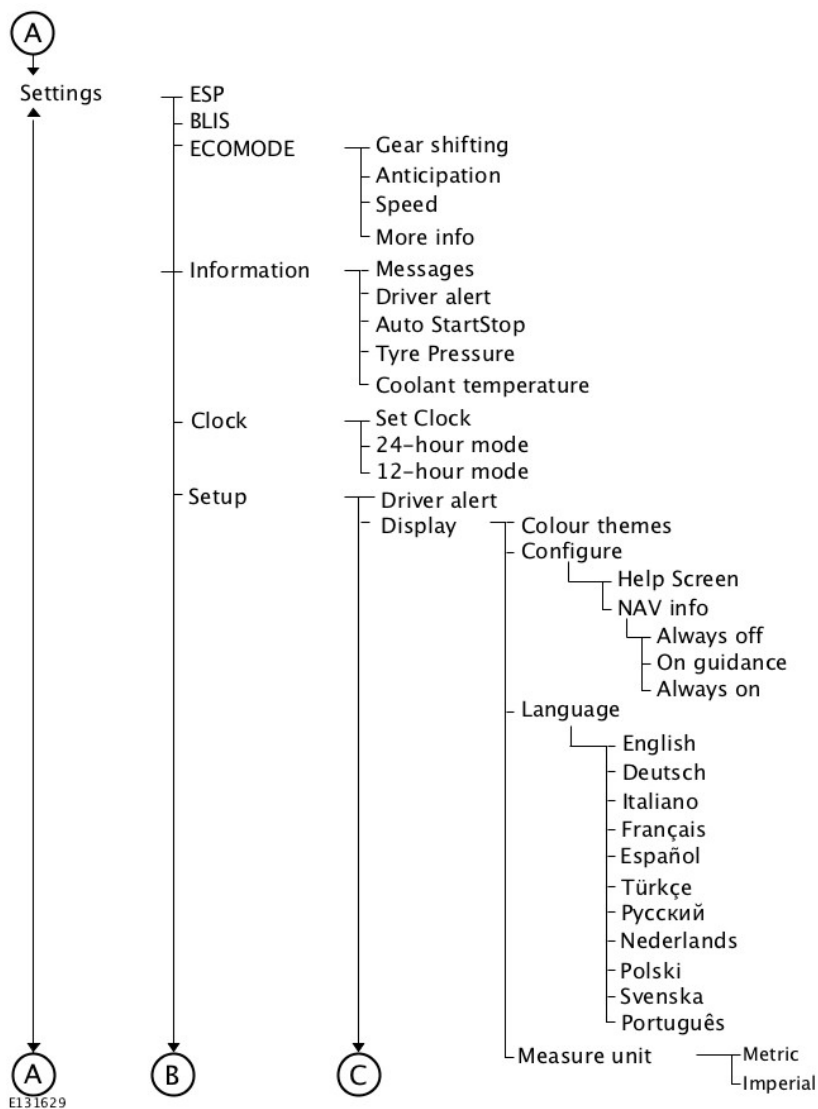

Information Displays

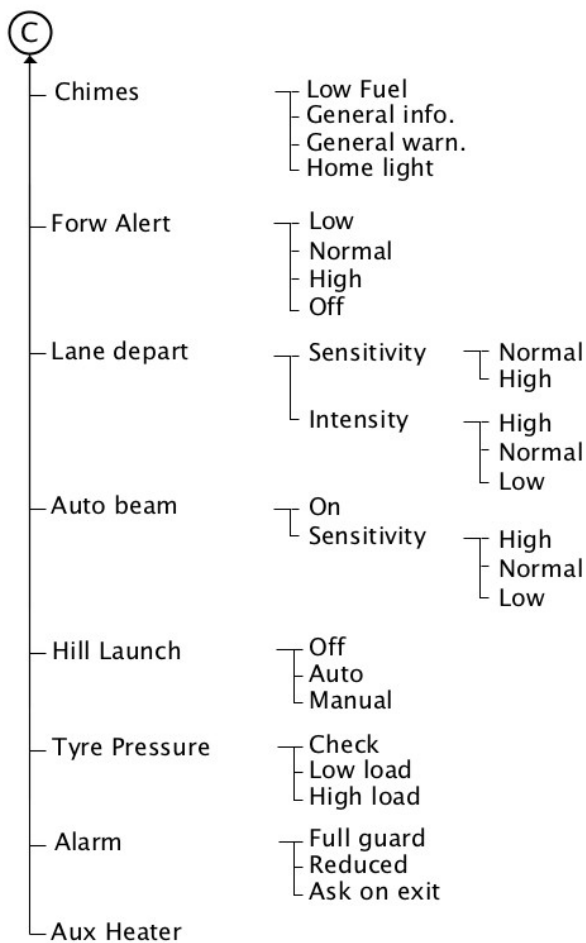

E131630

Information Displays

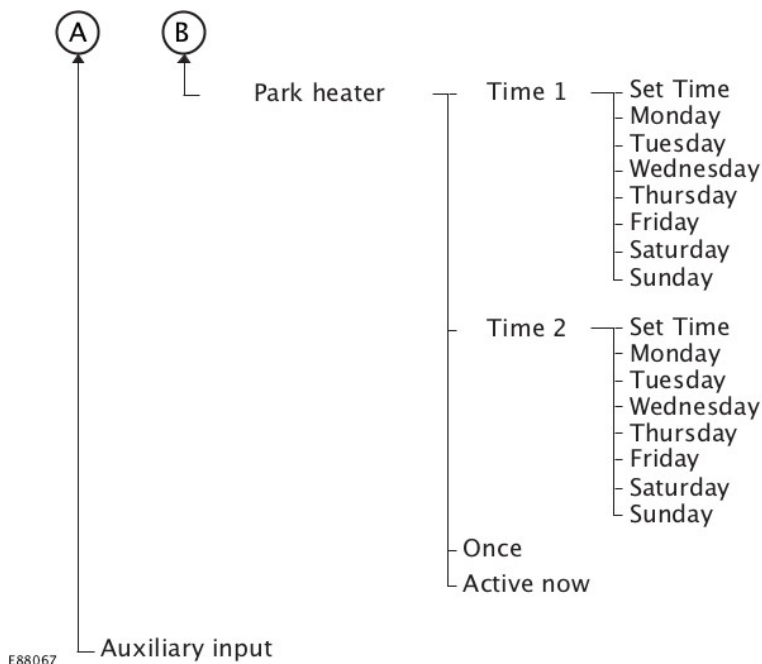

TRIP COMPUTER

Odometer

Registers the total mileage of the vehicle.

Tripmeter

Registers the mileage of individual journeys.

Distance to empty

Indicates the approximate distance the vehicle will travel on the fuel remaining in the tank. Changes in driving pattern may cause the value to vary.

Average fuel consumption

Indicates the average fuel consumption since the function was last reset.

Average speed

Indicates the average speed calculated since the function was last reset.

Outside air temperature

Shows the outside air temperature.

Information Displays

Type 1 and 2

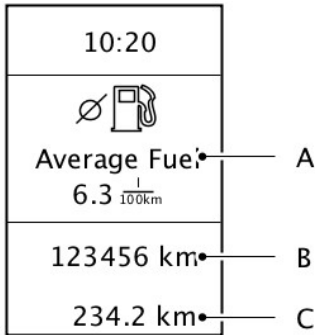

E74428

- A. Trip computer
- B. Odometer
- C. Tripmeter

The trip computer includes the following information displays:

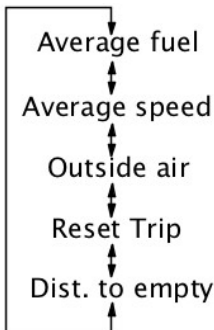

E74441

Press the **up** and **down** arrow buttons on the steering wheel to scroll through the trip computer displays.

Note: The position of the trip computer display may vary depending on the information shown in the display.

Resetting the trip computer using the main menu

To reset a particular display:

1. Press the right arrow button on the steering wheel to enter the main menu.
2. Highlight **Reset Trip** with the up and down arrow buttons and press the right arrow button.
3. Highlight the function to be reset.
4. Press the right arrow button to select the function.
5. Hold the **OK** button pressed.

To reset all three displays, select **All values** and hold the **OK** button pressed.

Type 3

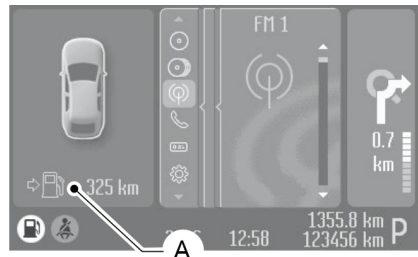

E88049

- A Trip computer

Press the **OK** button on the steering wheel to cycle through the different trip computer displays. To reset a value, press and hold the **OK** button.

Resetting the trip computer using the main menu

To reset a particular display:

1. Highlight **Trip Computer** with the up and down arrow buttons and press the right arrow button.
2. Highlight the function to be reset.

Information Displays

3. Hold the **OK** button pressed.

PERSONALISED SETTINGS

The following information is displayed in the information display if you have selected it:

Help screen, radio, navigation and phone information

The help screen appears for a few seconds when you switch the ignition on.

If the radio, navigation or telephone is operating, information relating to this system is displayed in the information display.

To select which information is displayed in the information display:

Type 1 and 2

1. Press the right arrow button on the steering wheel to enter the main menu.
2. Highlight **Setup** with the up and down arrow buttons and press the right arrow button.
3. Highlight **Display** and press the right arrow button.
4. Highlight **Configure** and press the right arrow button.
5. To toggle the **Help screen, Radio Info** and **Phone Info** on and off, highlight the desired setting and press the **OK** button to confirm the setting.
6. Press the left arrow button to exit the menu. Hold the left arrow button pressed to return to the trip computer display.

Type 3

1. Highlight **Settings** with the up and down arrow buttons and press the right arrow button.

2. Highlight **Setup** with the up and down arrow buttons and press the right arrow button.
3. Highlight **Display** and press the right arrow button.
4. Highlight **Configure** and press the right arrow button.
5. To toggle the **Help screen** and **NAV Info** on and off, highlight the desired setting and press the **OK** button to confirm the setting.

Navigation information

You can also choose when the navigation information is displayed in the information display. Three options are available:

- **Always off:** No navigation information is displayed in the information display.
- **On guidance:** The navigation information will only appear when the navigation system provides a guidance instruction. This function is only available on certain navigation systems.
- **Always on:** Navigation information will always appear in the information display when the navigation system is operating.

To set when navigation information should be displayed:

Type 1 and 2

1. Press the right arrow button on the steering wheel to enter the main menu.
2. Highlight **Setup** with the up and down arrow buttons and press the right arrow button.
3. Highlight **Display** and press the right arrow button.
4. Highlight **Configure** and press the right arrow button.
5. Highlight **Nav Info** and press the right arrow button.

Information Displays

6. Highlight the desired setting and press the **OK** button to confirm the setting.
7. Press the left arrow button to exit the menu. Hold the left arrow button pressed to return to the trip computer display.

Type 3

1. Highlight **Settings** with the up and down arrow buttons and press the right arrow button.
2. Highlight **Setup** with the up and down arrow buttons and press the right arrow button.
3. Highlight **Display** and press the right arrow button.
4. Highlight **Configure** and press the right arrow button.
5. Highlight **Nav Info** and press the right arrow button.
6. Highlight the desired setting and press the **OK** button to confirm the setting.

Language

A choice of eleven languages are available: English, German, Italian, French, Spanish, Turkish, Russian, Dutch, Polish, Swedish and Portuguese.

Type 1 and 2

1. Press the right arrow button on the steering wheel to enter the main menu.
2. Highlight **Setup** with the up and down arrow buttons and press the right arrow button.
3. Highlight **Display** and press the right arrow button.
4. Highlight **Language** and press the right arrow button.
5. Highlight the desired setting and press the **OK** button to confirm the setting.

6. Press the left arrow button to exit the menu. Hold the left arrow button pressed to return to the trip computer display.

Type 3

1. Highlight **Settings** with the up and down arrow buttons and press the right arrow button.
2. Highlight **Setup** with the up and down arrow buttons and press the right arrow button.
3. Highlight **Display** and press the right arrow button.
4. Highlight **Language** and press the right arrow button.
5. Highlight the desired setting and press the **OK** button to confirm the setting.

Units of measure

Note: *The outside air temperature is only displayed in degrees Celsius and cannot be set to degrees Fahrenheit.*

To select metric or imperial units:

Type 1 and 2

1. Press the right arrow button on the steering wheel to enter the main menu.
2. Highlight **Setup** with the up and down arrow buttons and press the right arrow button.
3. Highlight **Display** and press the right arrow button.
4. Highlight **Measure Unit** and press the right arrow button.
5. Highlight the desired setting and press the **OK** button to confirm the setting.
6. Press the left arrow button to return to exit the menu. Hold the left arrow button pressed to return to the trip computer display.

Information Displays

Type 3

1. Highlight **Settings** with the up and down arrow buttons and press the right arrow button.
2. Highlight **Setup** with the up and down arrow buttons and press the right arrow button.
3. Highlight **Display** and press the right arrow button.
4. Highlight **Measure Unit** and press the right arrow button.
5. Highlight the desired setting and press the **OK** button to confirm the setting.

INFORMATION MESSAGES



E70499

Press **OK** to acknowledge and remove some messages from the information display. Other messages will be removed automatically after a short time.

With instrument cluster type 3, certain messages need to be confirmed before you can access the menus.

Message indicator



The message indicator illuminates to supplement some messages. It will be red or amber depending on the severity of the message and will remain on until the cause of the message has been rectified.

Message symbols



See Owner's handbook.



Have the system checked at the next service.



Have the system checked as soon as possible.



Stop your vehicle as soon as it is safe to do so.

Viewing current messages

Type 1 and 2

1. Press the right arrow button on the steering wheel to enter the main menu.
2. Highlight **Information** with the up and down arrow buttons and press the right arrow button.
3. Highlight **Messages** and press the right arrow button.
4. Use the up and down buttons to view the current messages.

Type 3

1. Press the right arrow button on the steering wheel to enter the main menu.
2. Highlight **Settings** with the up and down arrow buttons and press the right arrow button.

Information Displays

3. Highlight **Information** with the up and down arrow buttons and press the right arrow button.
4. Highlight **Messages** and press the right arrow button.
5. Use the up and down buttons to view the current messages.

Active suspension

Message	Indicator	Action
IVDC malfunction	amber	Have the system checked by a properly trained technician.
IVDC comfort	-	See Active suspension (page 173).
IVDC normal	-	See Active suspension (page 173).
IVDC sport	-	See Active suspension (page 173).

Airbag

Message	Indicator	Action
Airbag malfunction	amber	Have the system checked by a properly trained technician as soon as possible.

Alarm

Message	Indicator	Action
Alarm triggered	amber	See Alarm (page 45).
Alarm system service reqd.	-	Have the system checked by a properly trained technician.

Automatic main beam control, Lane departure warning and Driver alert

Message	Indicator	Action
Driver fatigue Rest now	red	Stop and rest as soon as it is safe to do so.
Front camera Clean screen	amber	The front camera sensor has reduced visibility. Clean the windscreen.
Front camera malfunction	amber	The front camera sensor has malfunctioned. Have this checked as soon as possible.

Information Displays

Message	Indicator	Action
Front camera not available	amber	The affected systems are temporarily unavailable, and should resume after a few minutes.
Driver fatigue Rest suggested	amber	Take a rest break soon.
Lane departure warn. malfunc.	amber	The system has malfunctioned. Have this checked as soon as possible.

Battery and charging system

Message	Indicator	Action
Overvoltage: Stop safely!	red	Stop your vehicle as soon as it is safe to do so and switch off the ignition. Have the system checked by a properly trained technician as soon as possible.
Low battery	amber	Have the system checked by a properly trained technician as soon as possible.

Blind spot monitor

Message	Indicator	Action
BLIS sensor blocked	amber	See Blind Spot Monitor (page 79).
BLIS right sensor malfunction	amber	Have the system checked by a properly trained technician as soon as possible.
BLIS left sensor malfunction	amber	Have the system checked by a properly trained technician as soon as possible.
BLIS malfunction	amber	Have the system checked by a properly trained technician as soon as possible.
BLIS inactive Trailer attach'd	amber	See Blind Spot Monitor (page 79).

Information Displays

Child power lock

Message	Indicator	Action
Child lock malfunction	amber	Have the system checked by a properly trained technician as soon as possible.

Climate control

Message	Indicator	Action
Aux. Heater on	amber	See Auxiliary Heater (page 119).

Cruise control and Adaptive cruise control (ACC)

Message	Indicator	Action
ACC malfunction	amber	Have the system checked by a properly trained technician as soon as possible.
Clean radar sensor	amber	See Adaptive cruise control (ACC) (page 181).
Forward Alert malfunction	amber	Have the system checked by a properly trained technician as soon as possible.
ACC unavailable	-	See Adaptive cruise control (ACC) (page 181).
Cruise control active	-	See Cruise Control (page 179).
Cruise control standby	-	See Cruise Control (page 179).

Doors open

Message	Indicator	Action
Driver door open	red	Vehicle is moving. Stop the vehicle as soon as safely possible and close.
Driver side rear door open	red	Vehicle is moving. Stop the vehicle as soon as safely possible and close.
Passenger door open	red	Vehicle is moving. Stop the vehicle as soon as safely possible and close.

Information Displays

Message	Indicator	Action
Passenger side rear door open	red	Vehicle is moving. Stop the vehicle as soon as safely possible and close.
Luggage comp. open	red	Vehicle is moving. Stop the vehicle as soon as safely possible and close.
Bonnet open	red	Vehicle is moving. Stop the vehicle as soon as safely possible and close. See Opening and Closing the Bonnet (page 233).

Engine immobiliser

Message	Indicator	Action
Immobiliser active	amber	See Engine Immobiliser (page 44).

Hill start assist

Message	Indicator	Action
Hill Launch not available	amber	Have the system checked by a properly trained technician.
Please use park brake!	amber	See Hill Start Assist (page 170).
Hill Launch Assist active	-	See Hill Start Assist (page 170).
Hill Launch Assist off	-	See Hill Start Assist (page 170).

Keyless system

Message	Indicator	Action
Steering malfunction	red	Have this checked as soon as possible.
Key not detected	amber	See Keyless Entry (page 40).
Car operative Press STOP	amber	The engine is still running. Switch the ignition off. See Keyless Starting (page 144).

Information Displays

Message	Indicator	Action
Key outside car	amber	See Keyless Entry (page 40).
Key battery low	amber	See Changing the remote control battery (page 34).
Steering locked - Retry	-	See Steering Wheel Lock (page 146).

Lighting

Message	Indicator	Action
Front lights malfunction	amber	Have the system checked by a properly trained technician as soon as possible.
Low beam: Bulb fault	-	One or both of the headlamp dipped beam bulbs have blown. Check the headlamp dipped beam bulbs. See Changing a Bulb (page 64).
Rear fog light: Bulb fault	-	One or both of the rear fog lamp bulbs have blown. Check the rear fog lamp bulbs. See Changing a Bulb (page 64).
Stop lamps: Bulb fault	-	One or both of the brake lamp bulbs have blown. Check the brake lamp bulbs. See Changing a Bulb (page 64).
Trailer stopl.: Bulb fault	-	One or both of the brake lamp bulbs on your trailer have blown. Check the brake lamp bulbs on your trailer.
Trailer turnl.: Bulb fault	-	One or both of the direction indicator bulbs on your trailer have blown. Check the direction indicator bulbs on your trailer.

Information Displays

Maintenance

Message	Indicator	Action
Engine malfunction	red	Have the system checked by a properly trained technician as soon as possible.
Check engine oil level	amber	See Engine Oil Check (page 244).
Water detected in fuel	amber	Have the system checked by a properly trained technician as soon as possible.
Low washer fluid level	-	See Washer Fluid Check (page 246).
Service oil	-	Have the system checked by a properly trained technician.

Occupant protection

Message	Indicator	Action
Crash mode	-	Have the system checked by a properly trained technician as soon as possible.

Parking brake

Message	Indicator	Action
Park brake applied	red	See Parking Brake (page 165).
Park brake applied	amber	See Parking Brake (page 165).

Electric parking brake (EPB)

Message	Indicator	Action
Park brake malfunction	red	Have the system checked by a properly trained technician as soon as possible.
Release park brake	red	See Electric Parking Brake (page 166).
Re-Apply park brake	red	See Electric Parking Brake (page 166).

Information Displays

Message	Indicator	Action
Park brake applied	amber	See Electric Parking Brake (page 166).
Park brake released	amber	See Electric Parking Brake (page 166).
Park brake service reqd.	-	Have the system checked by a properly trained technician.

Power steering

Message	Indicator	Action
Power steering malfunction	amber	Full steering will be maintained but you will need to exert greater force on the steering wheel. Have the system checked by a properly trained technician as soon as possible.

Stability control (ESP)

Message	Indicator	Action
ESP malfunction	-	Have the system checked by a properly trained technician as soon as possible.
ESP off	-	See Using Stability Control (page 169).

Start-stop

Message	Message indicator	Action
Auto StartStop Switch ign off	red	Switch the ignition off before leaving the vehicle if the system has shut down the engine. See Using start-stop (page 151).
Auto StartStop Press clutch	-	The engine needs to be restarted, press the clutch pedal to start. See Using start-stop (page 151).
Auto StartStop Select neutral	-	Select neutral for the system to restart the engine. See Using start-stop (page 151).
StartStop: Man. start required	-	The system is not functioning. A manual restart is required.

Information Displays

Transmission

Message	Indicator	Action
Transmission malfunction	red	Have the system checked by a properly trained technician immediately.
Transmission over-temperatur	amber	Have the system checked by a properly trained technician as soon as possible.

Tyre pressure monitoring system

Message	Indicator	Action
Check tyre!	red	The tyre indicated has continued to deflate. Check the tyre and inflate it to the recommended pressure. See Technical Specifications (page 262).
Check tyre pressures	red	One or more of the tyres are significantly under-inflated. This message may be displayed after a new sensor has been installed. Check the tyres and inflate them to the recommended pressure. See Technical Specifications (page 262).
Check tyre	amber	The tyre indicated is significantly under-inflated. Check the tyre and inflate it to the recommended pressure. See Technical Specifications (page 262).
Tyre monitor malfunction	amber	You have installed a temporary spare wheel. Install a correctly inflated full size wheel with a sensor as soon as possible. When a malfunction occurs, the system may not be able to detect or signal low tyre pressure.
		Up to three sensors have malfunctioned, an unapproved accessory is interfering with the system or a general malfunction has been detected. Have the system checked by a properly trained technician as soon as possible. When a malfunction occurs, the system may not be able to detect or signal low tyre pressure.

Information Displays

Message	Indicator	Action
Inflate tyres for high speed	amber	The tyre pressures are not suitable for driving at 160 km/h (100 mph). Inflate the tyres to the recommended pressure. See Technical Specifications (page 262). This message will be displayed for only a few seconds with a low tyre pressure warning.
Tyre sensors not detected	-	You have installed wheels and tyres that do not have sensors. The tyre pressures will not be monitored.
		All sensors have malfunctioned or an unapproved accessory is interfering with the system. Have the system checked by a properly trained technician as soon as possible.

Voice control

Message	Indicator	Action
Voice control Please speak	-	See Voice control (page 300).
Voice control Not recognised	-	See Voice control (page 300).
Voice control Not allowed	-	See Voice control (page 300).

Climate Control

PRINCIPLE OF OPERATION

Outside air

Keep the air intakes forward of the windscreen free from obstruction (snow, leaves etc.) to allow the climate control system to function effectively.

Recirculated air

CAUTION

! Prolonged use of recirculated air may cause the windows to mist up. If the windows mist up, follow the settings for defrosting and demisting the windscreen.

The air currently in the passenger compartment will be recirculated. Outside air will not enter the vehicle.

Heating

Heating performance depends on the temperature of the engine coolant.

Air conditioning

Note: *The air conditioning operates only when the temperature is above 4°C (39°F).*

Note: *If you use the air conditioning, the fuel consumption of your vehicle will be higher.*

Air is directed through the evaporator where it is cooled. Humidity is extracted from the air to help keep the windows free of mist. The resulting condensation is directed to the outside of the vehicle and it is therefore normal if you see a small pool of water under your vehicle.

General information on controlling the interior climate

Fully close all the windows.

Warming the interior

Direct the air towards your feet. In cold or humid weather conditions, direct some of the air towards the windscreen and the door windows.

Cooling the interior

Direct the air towards your face.

AIR VENTS

Front air vents



E71942

Climate Control

Second row air vents

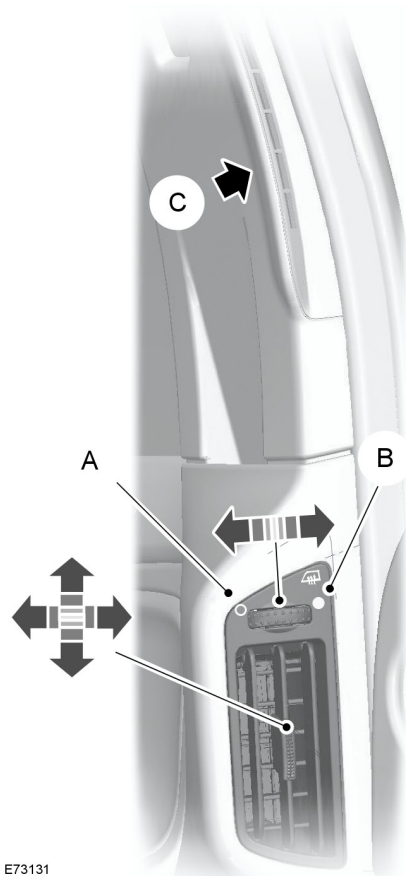

E73131

- A Air flow through lower air vent
- B Air flow through upper air vent
- C Upper air vent

Use the upper air vents to defrost or demist the side windows.

Third row air vents

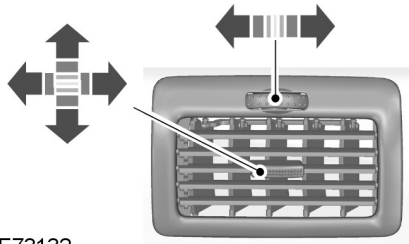

E73132

MANUAL CLIMATE CONTROL

Air distribution control

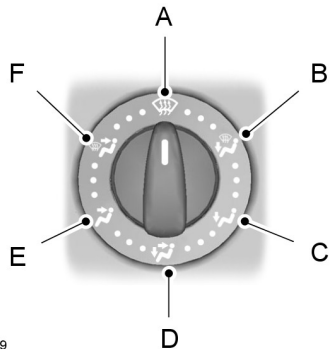

E71379

- A Windscreens
- B Footwell and windscreens
- C Footwell
- D Face level and footwell
- E Face level
- F Face level and windscreens

You can set the air distribution control to any position between the symbols.

Climate Control

Blower

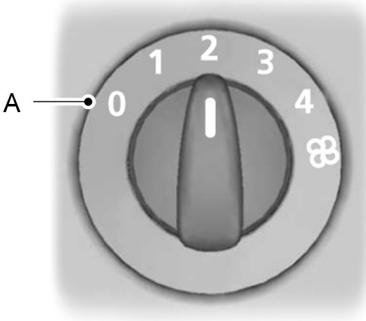

E75470

A Off

Note: If you switch the blower off, the windscreen may mist up.

Recirculated air



Press the button to toggle between outside air and recirculated air.

Heating the interior quickly

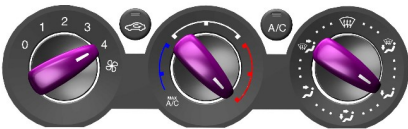

E71377

Ventilation

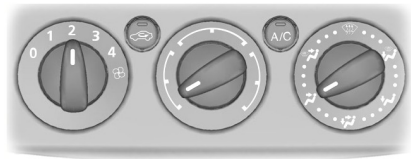

E71378

Set the air distribution control, blower and air vents to suit your requirements.

Air conditioning

Switching the air conditioning on and off

A/C

If you turn the blower off, the air conditioning will turn off. When you turn the blower on again, the air conditioning will come on automatically.

Cooling with outside air

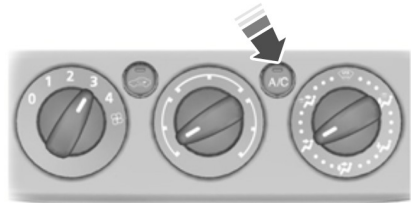

E71380

Climate Control

Cooling the interior quickly

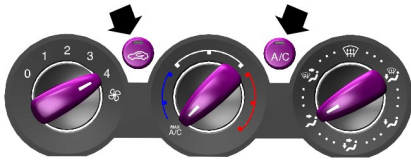

E71381

Defrosting and demisting the windscreen

Note: Turn the air conditioning on to assist windscreen and side window demisting.

Note: Turn the heater control to maximum heat to assist windscreen and side window defrosting.

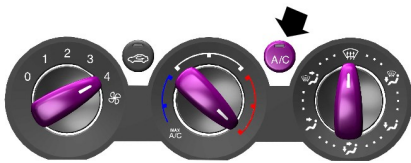

E71382

Make sure that the blower and **A/C** is on. The indicator in the switch will illuminate during defrosting and demisting.

If you move the air distribution control to a position other than **A**, the **A/C** will remain on.

You can switch the air conditioning and recirculated air on and off while the air distribution control is set to position **A**.

If necessary, switch the heated windows on. See **Heated Windows and Mirrors** (page 119).

Note: To defrost or demist the rear side windows, set the second row air vents to the defrosting and demisting position. See **Air Vents** (page 111).

Reducing interior air humidity

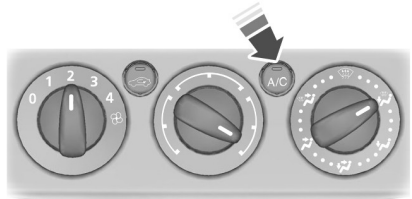

E71383

Climate Control

AUTOMATIC CLIMATE CONTROL

Dual-zone



E80737

Triple-zone



E70302

Your vehicle is fitted with either a dual-zone or triple-zone system. When the system is in mono mode, all the temperature zones are linked to the driver's zone. When you switch mono mode off, the dual-zone system allows you to set different temperatures for the driver's and passenger's side. On vehicles fitted with a triple-zone system, you can set a third temperature for the rear.

The system controls the temperature, amount and distribution of the air flow automatically and adjusts them according to the driving and weather conditions. Press the **AUTO** button to switch auto mode on.

Climate Control

Note: Avoid adjusting the settings when the vehicle interior is extremely hot or cold. The system adjusts to the current circumstances automatically. For the system to function properly, the side and centre air vents should be fully open.

Note: At low outside air temperatures, when the system is in auto mode, the air stream will be directed to the windscreens and the side windows as long as the engine is cold.

Note: For information on the automatic climate control, on vehicles fitted with a combined Navigation and automatic climate control system, see separate handbook.

Setting the temperature



E70304

You can set the temperature between 16°C (61°F) and 28°C (82°F) in steps of 0.5°C (1°F). In position **LO** (below 16°C [61°F]) the system will switch to permanent cooling, in position **HI** (above 28°C [82°F]) to permanent heating, and will not regulate a stable temperature.

Mono mode

In mono mode, the temperature settings for both the driver's and passenger's side are linked. If you adjust the temperature using the rotary control on the driver's side, the same temperature will be set for the passenger's side. **MONO** is shown in the display.

To switch mono mode off

Select a temperature for the passenger's side using the rotary control on the passenger's side. Mono mode will switch off and **MONO** disappears from the display. The temperature for the driver's side will remain unchanged. You can now adjust the driver's and passenger's side temperatures independently of each other. The temperatures are shown in the display. You can set a difference of up to 4°C (8°F).

Note: If you set a difference of greater than 4°C (8°F), the temperature on the other side will be adjusted so that the difference remains at 4°C (8°F).

Note: If you set one of the sides to **HI** or **LO**, both sides will be set to **HI** or **LO**.

To switch mono mode back on



Press the **MONO** button. **MONO** is shown in the display, and the passenger's side temperature will be adjusted to the driver's side temperature.

Blower

High speed



Low speed

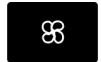

Use the buttons to adjust the blower speed.

The blower setting is shown in the display.



Climate Control

To return to auto mode, press the **AUTO** button.

Air distribution

To adjust air distribution, press the desired button. Any combination of settings can be selected simultaneously.

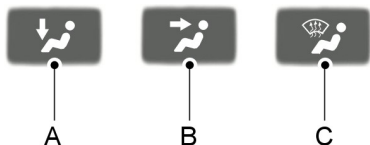

E70308

- A Footwell
- B Face level
- C Windscreen

Windscreen defrosting and demisting



When you select windscreen defrosting and demisting, **A**, **B** and **C** switch off automatically and the air conditioning switches on. Outside air will flow into the vehicle. You cannot select recirculated air.

The blower speed and the temperature control operate automatically and cannot be adjusted manually. The blower is set to high speed and the temperature to **HI**.

When you select windscreen defrosting and demisting, the heated screens switch on automatically and switch off after a short time.

To return to auto mode, press the **AUTO** button.

Note: To defrost or demist the rear side windows, set the second row air vents to the defrost or demist position. See **Air Vents** (page 111).

Switching the air conditioning on and off



Press the button. **A/C OFF** or **A/C ON** is shown in the display.

Recirculated air



Press the button to change between outside air and recirculated air.

Note: When the system is in auto mode and the interior and exterior air temperatures are quite hot, the system selects recirculated air automatically to maximise cooling of the interior. Once the selected temperature is reached, the system will automatically reselect outside air.

Switching the automatic climate control on and off

Note: When switched off, the heating, ventilation and air conditioning system for both front and rear zones are switched off and recirculated air is selected.

Dual-zone



E70980

Use the buttons to switch the system on and off.

Climate Control

Triple-zone

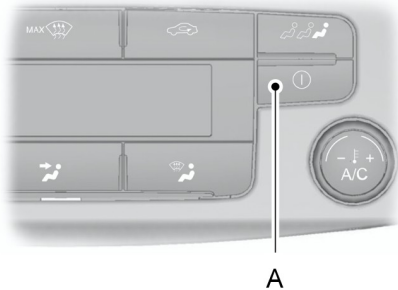

E70312

Press button **A** to switch the system on and off.

Rear air conditioning (triple-zone automatic climate control)

Note: This is a cooling system only. You can use it to cool the rear. The system will not change the rear setting to a temperature higher than the average of the two front temperature settings.

Note: When switched off, you cannot set a temperature for the rear which is lower than the average of the two front temperature settings.

Switching between front and rear air conditioning mode

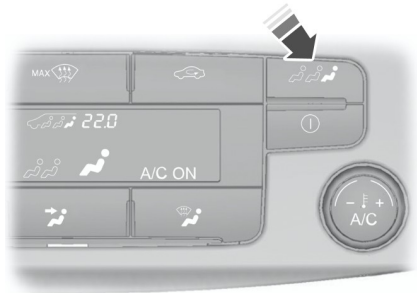

E70313

Press the button. The rear air conditioning symbol and the rear settings will be shown in the display.

When the system is in rear air conditioning mode, you can select a temperature using the rotary control on the driver's side.

To return to the front settings, press the button again. If no button is pressed for a few seconds, the system will automatically return to the front settings.

Rear temperature

Note: If you set different temperatures for the driver's side and rear, mono mode will be switched off.

Note: When you press the **MONO** button, all three temperature zones will be adjusted to the temperature set for the driver's side.

Switching the rear air conditioning on and off



When the system is in rear air conditioning mode, use the button to switch the system on and off. **A/C OFF** or **A/C ON** is shown in the display.

Climate Control

Note: When the front air conditioning is switched off, you cannot have rear air conditioning.

Rear blower

High speed



Low speed



When the system is in rear air conditioning mode, use the buttons to adjust the blower speed.

The blower setting is shown in the display.



When the system is in rear air conditioning mode, press the **AUTO** button to return to auto mode. In auto mode, the rear blower is automatically controlled. **AUTO** is shown in the display.

Switching the rear automatic climate control on and off



A

E70312

When the system is in rear air conditioning mode, press button **A** to switch only the rear system on and off.

HEATED WINDOWS AND MIRRORS

Heated windows

Use the heated windows to defrost or demist the windscreen or rear window.

Note: The heated windows operate only when the engine is running.

Heated windscreen



Heated rear window



Heated exterior mirrors

Electric exterior mirrors are fitted with a heating element that will defrost or demist the mirror glass. They will switch on automatically when you switch the heated rear window on.

AUXILIARY HEATER

Parking heater

WARNING



The parking heater must not be operated at filling stations, near sources of combustible vapours or dust or in enclosed spaces.

Climate Control

The parking heater operates independently of the vehicle heater by heating the engine's coolant circuit. It is fed from the vehicle fuel tank. You can also use it while the vehicle is in motion to help the vehicle heater warm up the interior more quickly.

Used properly, the parking heater provides the following benefits:

- It preheats the interior of the vehicle.
- It keeps the windows clear of ice in the event of frost and prevents condensation.
- It avoids cold starts and allows the engine to reach operating temperature sooner.

Note: The parking heater will only operate if there is at least 7.5 litres (1.6 gallons) of fuel in the fuel tank and the ambient temperature is below 15°C (59°F). The heater will not operate if the battery is low.

Note: The heating depends on the outside air temperature.

Note: When the parking heater is activated, exhaust fumes may come from under the sides of the vehicle. This is normal.

Note: On vehicles with a manual heating, ventilation and air conditioning system, the heating of the vehicle interior is dependent on the temperature, air distribution and blower control settings.

To prevent the battery from discharging:

- Once the parking heater has performed one heating cycle, the next programmed heating cycle will only be carried out if you have started the vehicle's engine in between.
- After a heating cycle, drive the vehicle for at least the period of the heating cycle.

Programming the parking heater

Note: The programmed time is the time at which you wish the vehicle to be warm and ready to drive, not the time at which the heater switches on.

Note: You must programme the times at least 70 minutes in advance of the time you wish to set.

Note: You must set the time and date correctly. See **Clock** (page 136).

To programme the heating times:



E70499

1. Press the right arrow button on the steering wheel to enter the main menu.
2. Highlight **Setup** with the up and down arrow buttons and press the right arrow button.
3. Highlight **Park Heater** and press the right arrow button.

Climate Control

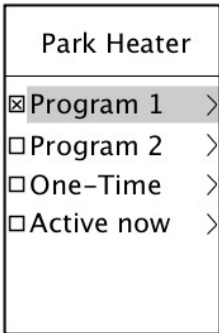

E74467

- The functions **Program 1** and **Program 2** allow you to programme up to two heating cycles for each day of the week. These times will remain stored and the heater will warm up the vehicle at these times on these days every week.
- The function **One-Time** allows you to programme one heating cycle for one specific day.
- The function **Active now** automatically switches on the heater.

Programming the functions Program 1 and Program 2

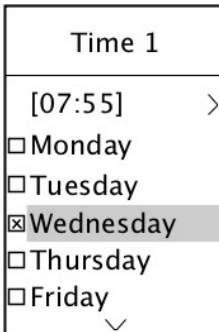

E74468

1. Highlight **Program 1** and press the right arrow button.
2. Highlight the day on which the heater should warm up the vehicle.
3. Press the **OK** button to confirm the selection. A cross appears in the box next to the day to show that this day is selected.
4. Continue in the same way to select all the days on which the heater should warm up the vehicle.
5. To set the time at which the vehicle should be warmed up, highlight the time at the top of the display and press the right arrow button.
6. Press the **OK** button and the hours flash. Use the up and down arrow buttons to adjust the individual settings and the left and right arrow buttons to move to the next or previous setting.
7. When you have finished, press the **OK** button again to confirm the selection.

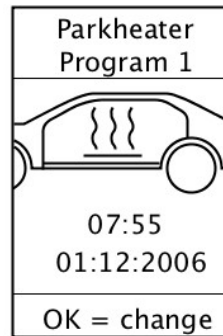

E74469

You can use the function **Program 2** to set a second cycle, for example different times on different days or twice on the same day. The programming procedure is the same as for the function **Program 1**.

Climate Control

Programming the function One-Time

1. Highlight **One-Time** and press the right arrow button.
2. Press the **OK** button and the hours flash. Use the up and down arrow buttons to adjust the individual settings and the left and right arrow buttons to move to the next or previous setting.
3. When you have finished, press the **OK** button again to confirm the selection.

Active now

Highlight **Active now** and press the **OK** button. A cross appears in the box next to the function to show that the heater is activated.

To deactivate the heater, highlight **Active now** and press the **OK** button again.

Remote starting

The parking heater may be started and switched off from a distance of up to 500 metres (1640 feet) using the supplied remote control transmitter. This range will vary depending upon local conditions and terrain, as well as battery condition. The remote control transmitter will indicate whether or not the signal has been received. The parking heater will operate for a maximum of 30 minutes.

Note: *The heater will operate, depending on the ambient temperature, for between 10 and 30 minutes. The interior will cool down after the heating period has elapsed, therefore a remote start more than 30 minutes before driving is not recommended.*

Note: *The remote control may not always receive confirmation of a successful remote command at extended operating ranges.*

Starting

Hold the transmitter with the antenna upwards and press the ON button for at least two seconds. The LED on the transmitter lights up green to confirm the signal has been received.

Switching off

Hold the transmitter with the antenna upwards and press the OFF button for at least two seconds. The LED on the transmitter lights up red to confirm the signal has been received.

Remote start in combination with direct start or timer



E114360

Remote start is integrated with normal heater control. Parking heaters started with direct start or timer functions can be switched off with the remote control transmitter and vice versa.

Feedback during starting and switching off

The LED on the transmitter illuminates green for about two seconds. This indicates the signal has been received by the vehicle and the heater has started.

The LED on the transmitter illuminates red for about two seconds. This indicates the signal has been received by the vehicle and the heater has switched off.

Climate Control

The LED on the transmitter flashes green or red for about two seconds. This indicates the signal was not transmitted correctly. Repeat the transmission.

The LED on the transmitter illuminates orange for about two seconds before showing green or red. This indicates the transmitter batteries are weak and should be changed.

The LED on the transmitter flashes orange for about 5 seconds. This indicates that the signal was not transmitted. The transmitter batteries are discharged and should be changed as soon as possible.

Changing the remote control battery

Make sure that you dispose of old batteries in an environmentally friendly way. Seek advice from your local authority regarding recycling.

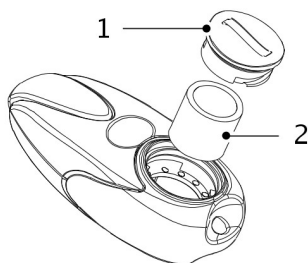

E114361

1. Insert a screwdriver or other suitable tool into the slot on the back of the remote control, and unscrew the compartment cover.

CAUTION



Do not touch the battery contacts or the printed circuit board with the screwdriver.

2. Carefully prise out the battery.

3. Install a new battery (3.3V type CR1-3N) with the + facing upwards.
4. Re-assemble the remote control.

Programming the transmitter

Further transmitters may be used with the remote system, please consult your dealer. Up to a maximum of 3 separate remote controls may be added. When adding extra transmitters these must be programmed separately.

Note: The heater must be switched off during programming.

Note: The programming procedure may be repeated as often as is required. The oldest programmed transmitter will be deleted each time.

1. Install the battery in the new transmitter.
2. Turn off the power to the receiver by removing fuse F32 from the engine compartment fuse box. See **Fuse Specification Chart** (page 222).
3. Wait for at least 5 seconds.
4. Reconnect power to the receiver by replacing the fuse, and press the OFF button on the new transmitter within 5 seconds until the LED light turns off.
5. The new transmitter is now programmed.

Fuel operated heater (depending on country)

WARNING



The fuel operated heater must not be operated at filling stations, near sources of combustible vapours or dust or in enclosed spaces.

Climate Control

The fuel operated heater aids in warming the engine and the vehicle interior on vehicles with a diesel engine. It is switched on or off automatically depending on the outside air temperature and the coolant temperature, unless you have deactivated it. When the fuel operated heater is operating, **Aux. Heater on** is displayed in the information display. See **Information Displays** (page 88).

To deactivate the fuel operated heater:



E70499

1. Press the right arrow button on the steering wheel to enter the main menu.
2. Highlight **Setup** with the up and down arrow buttons and press the right arrow button.
3. Highlight **Aux. Heater** and press the **OK** button to toggle the heater on and off. A cross appears in the box when the heater is activated.
4. Press the left arrow button to exit the menu. Hold the left arrow button pressed to return to the trip computer display.

Diesel auxiliary heater (depending on country)

The diesel auxiliary heater (PTC electrical heater) aids in warming the vehicle interior on vehicles with a diesel engine. It is switched on or off automatically depending on the outside air temperature, the coolant temperature and the alternator load.

Seats

SITTING IN THE CORRECT POSITION

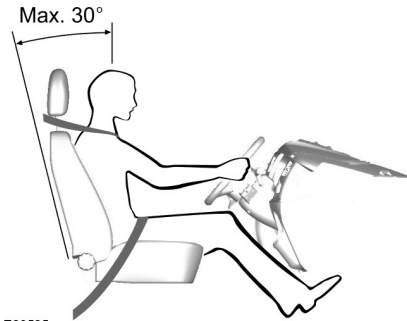

E68595

WARNINGS



Do not adjust the seats when the vehicle is moving.



Only when you use the seat belt properly, can it hold you in a position that allows the airbag to achieve its optimum effect.

When you use them properly, the seat, head restraint, seat belt and airbags will provide optimum protection in the event of a collision. We recommend that you:

- sit in an upright position with the base of your spine as far back as possible.
- do not recline the seatback more than 30 degrees.
- adjust the head restraint so that the top of it is level with the top of your head and as far forwards as possible, remaining comfortable.
- keep sufficient distance between yourself and the steering wheel. We recommend a minimum of 250 millimetres (10 inches) between your breastbone and the airbag cover.
- hold the steering wheel with your arms slightly bent.

- bend your legs slightly so that you can press the pedals fully.
- position the shoulder strap of the seat belt over the centre of your shoulder and position the lap strap tightly across your hips.

Make sure that your driving position is comfortable and that you can maintain full control of your vehicle.

MANUAL SEATS

Moving the seats backwards and forwards

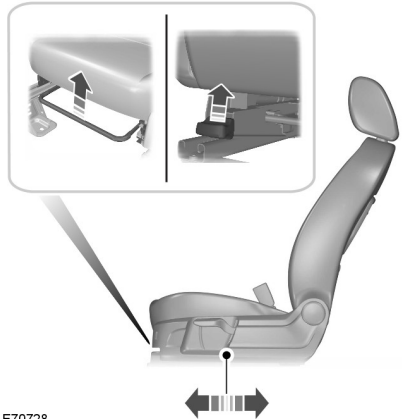

WARNING



Rock the seat backwards and forwards after releasing the lever to make sure that it is fully engaged in its catch.

Seats

Adjusting the lumbar support

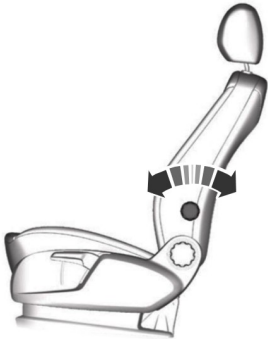

E70729

Adjusting the height of the driver's seat

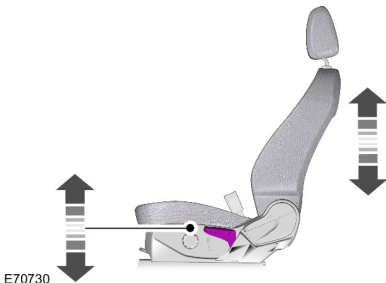

E70730

Adjusting the angle of the seatback

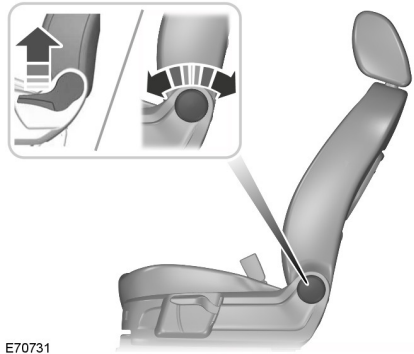

E70731

POWER SEATS

2-way electric seat

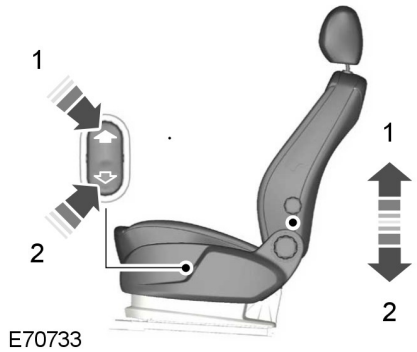

E70733

Seats

8-way electric seat

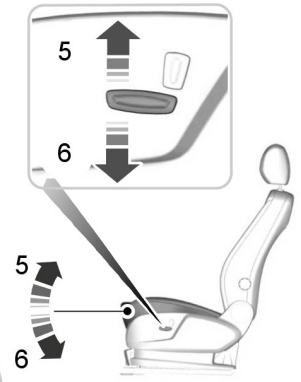
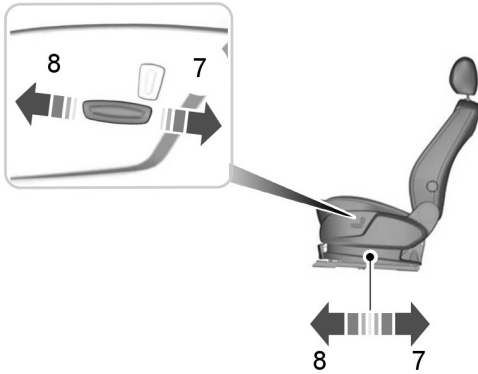
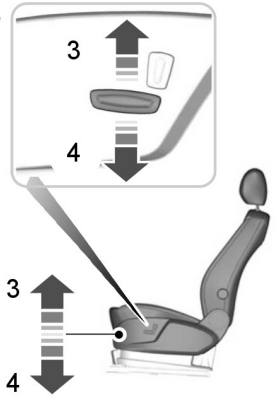
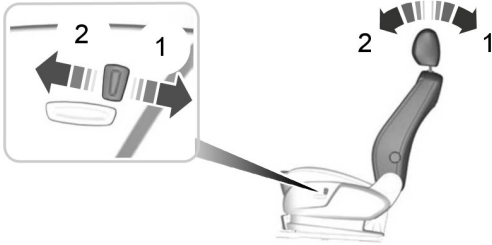

E70734

Seats

HEAD RESTRAINTS

Adjusting the head restraint

WARNINGS



Raise the rear head restraint when the rear seat is occupied by a passenger.



When using a forward facing child restraint on a rear seat, always remove the head restraint from that seat.

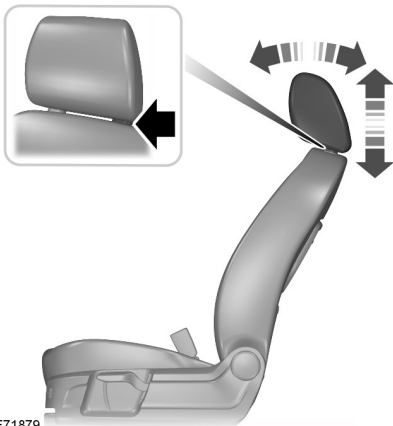

E71879

Adjust the head restraint so that the top of it is level with the top of your head and as far forwards as possible, remaining comfortable.

Removing the head restraint

Press the locking buttons and remove the head restraint.

REAR SEATS

Second Row Seats

Moving the Seats Backward and Forward

WARNING



Rock the seat backward and forward after releasing the lever to make sure that it is fully engaged in its catch.



E72644

Seats

Adjusting the Seatback



E72645

To recline the seatback, pull the lever on the outboard seats or the strap on the centre seat and lean back against the seatback until it reaches the desired position.

To raise the seatback, pull the lever up and push the seat cushion forward using your weight.

Easy Entry Position (Vehicles with Third Row Seats Only)

Note: You can move the outboard seats forward to allow access to the third row seats.



E72704

1. Pull the lever once. Fold the seatback forward into the position shown and slide the complete seat forward.



E72706

2. When exiting your vehicle from the third row seats, pull the loop on the rear of the second row seat.
3. To return the seat to the seating position, slide the seat backward. The seat will stop automatically and at a midway position.
4. Fold the seatback up until it engages.

Seats

5. To move the seat further back, pull the lever under the front of the seat and slide it backward.

Folding the Seatbacks Down

WARNING



When folding the seatbacks down, hold the seatback to avoid getting your fingers caught between the seatback and seat frame.

1. Lower the head restraints. See **Head Restraints** (page 128).
2. Slide the seats backward as far as they will go.
3. Insert the centre seat belt into the retainer in the roof. See **Fastening the seat belts** (page 30).



E72705

4. On the outboard seats, pull the lever and fold the seatback into a sloped position.



E72646

5. Pull the lever again and fold down the seatback.
6. On the centre seat, pull the loop between the seat cushion and the seatback and fold down the seatback.
7. To engage the seatbacks in the folded position, pull the lever or loop again and push the seatback firmly down until it latches into position.

To return the seat to the seating position, pull the lever or loop and fold the seatback up until it engages.

Third Row Seats

WARNING



Do not sit in a third row seat when the second row seat in front of it is folded flat.

Moving the Seats Backward and Forward (Galaxy)

WARNING



Rock the seat backward and forward after releasing the lever to make sure that it is fully engaged in its catch.

Seats



E72647

Adjusting the Seatback (Galaxy)



E75381

To recline the seatback, pull the strap and lean back against the seatback until it reaches the desired position.

To raise the seatback, pull the strap and let the seatback return to the upright position.

Folding the Seats Flat

WARNING



When folding the seatbacks down, hold the seatback to avoid getting your fingers caught between the seatback and seat frame.

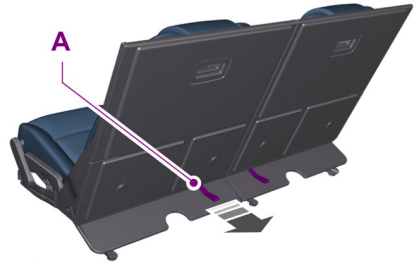

E152858

1. Pull loop A at the rear of the seat cushion.



E72707

2. The seat cushion will automatically turn over and lie flat on the floor (1). The seatback will automatically fold down.

Seats

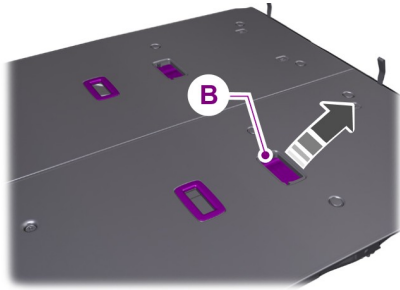

E153934

3. To return the seat to the seating position. Fold the carpeted cover back, grasp the grip (B) and pull the seatback upward and then rearward.
4. Fold the seat cushion back and lock in to position.

Creating a Level Load Floor

WARNING



When transporting a load with the seats folded flat, always fold the relevant carpeted cover forward to cover the folded seats.

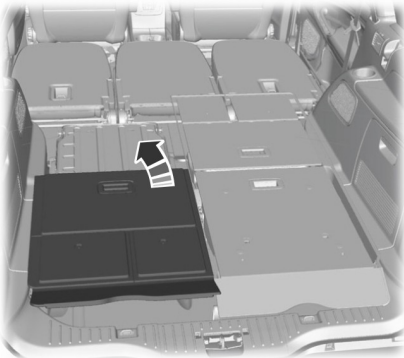

E153404

The carpeted cover is held in position by magnets, fold the carpeted cover forward to cover up the folded seats.

Note: When only the third row seats are folded flat, fold the covers forward to cover up the base of the second row seats. The smaller flaps at the front of the cover should stand vertically against the second row seatbacks.

HEATED SEATS

Note: Operating this function with the engine off will drain the battery.



E70601



E71224

Seats

Note: The number of illuminated lights beside the button indicates the selected step.

Note: The heater setting is indicated in red.

Note: When no light is illuminated, the heating is switched off.

Note: Only the front seat settings are stored when you switch off the ignition.

Raising and Lowering the Temperature

Press and hold the relevant button or press it repeatedly to select the desired temperature.

VENTILATED SEATS

Note: Operating this function with the engine off will drain the battery.



E70601



E70602

Note: The number of illuminated lights beside the button indicates the selected step.

Note: The ventilation setting is indicated in blue.

Note: When no light is illuminated, the ventilation is switched off.

Note: The settings are stored when the ignition is switched off.

Note: When the seat is being ventilated, the heater may switch on automatically. This is to prevent the flow of air becoming uncomfortably cool.

Note: The air in the vehicle interior is used to ventilate the seats. The cooling effect therefore depends on the temperature of the vehicle interior. Switch on the air conditioning if necessary and set the air distribution to footwell. See **Climate Control** (page 111).

Raising and Lowering the Temperature

Press and hold the relevant button or press it repeatedly to select the desired temperature.

Seats

FRONT SEAT ARMREST

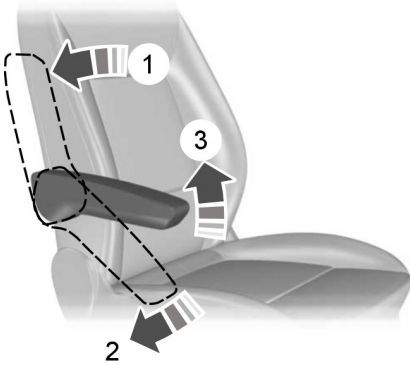

E95256

Convenience features

SUN SHADES

Side windows

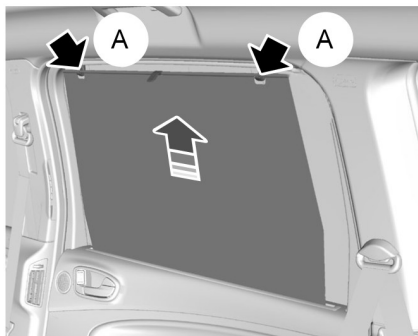

E74809

Pull the blind up and attach it to the hooks (A).

Roof (Galaxy)

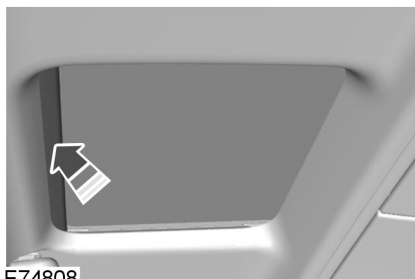

E74808

Roof (S-MAX)

WARNING



Do not operate the sun blind unless it is free from obstruction.

Note: If you operate the switch often during a short period of time, the system might become inoperable for a certain time to prevent damage due to overheating.

Note: The sun blind can only be operated when the ignition is on.

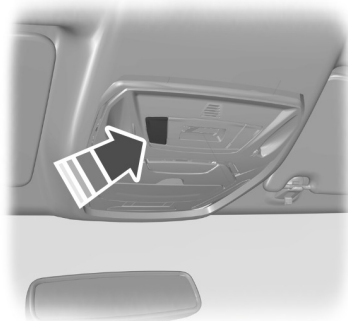

E125025

The sun blind is operated by a switch located between the sun visors.

Opening and closing the sun blind

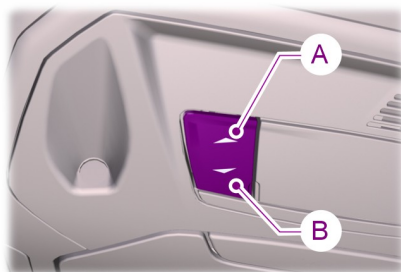

E125146

A Press to close

B Press to open

Convenience features

Opening and closing the sun blind automatically

Press the switch to the second action point and release it. Press it again to stop the blind.

Note: *If this does not operate correctly, follow the relearning procedure below.*

Anti-trap function

WARNINGS



The anti-trap function is deactivated until the memory has been reset by the relearning procedure.



Careless closing of the blind can override the anti-trap function and cause injuries.

The sun blind will stop automatically while opening or closing and reverse some distance if there is an obstacle in the way.

Sun blind relearning

WARNING



The anti-trap function is not active during this procedure. Make sure that there are no obstacles in the way of the moving blind.

Note: *The relearning process must be started no later than 30 seconds after turning the ignition on.*

In case the blind no longer opens or closes properly, follow this relearning procedure:

1. Press switch **B** to the first action point twice and release it within two seconds.
2. Press switch **A** to the first action point twice and release it within two seconds.

3. Press and hold switch **B** to the first action point, until the blind fully opens.
4. Press and hold switch **A** to the first action point, until the blind fully closes.

If step 2 is not completed within 15 seconds, the relearning function will be interrupted. Turn the ignition off, wait for another 30 seconds and then turn the ignition back on again. Start the procedure once more from the beginning.

Confirm that relearning has been completed by using automatic opening and closing.

INSTRUMENT LIGHTING DIMMER



E70723

CLOCK

Note: *Some navigation systems will automatically set the date and time on the clock using GPS signals.*

Note: See **General Information** (page 88).

1. From the main menu, select the clock function.
2. Select the option required.
3. Press **OK**.
4. Using the right, left, up and down arrow buttons, select and change the value.

Convenience features

5. Press **OK**.

CIGAR LIGHTER

CAUTIONS

- ! If you use the socket when the engine is not running, the battery may discharge.
- ! Do not hold the cigar lighter element pressed in.

Note: Switch the ignition on to use the cigar lighter. You can also use it for up to 30 minutes after you have switched the ignition off.

Note: You can use the socket to power 12 volt appliances that have a maximum current rating of 15 Amperes. Use only Ford accessory connectors or connectors specified for use with SAE standard sockets.

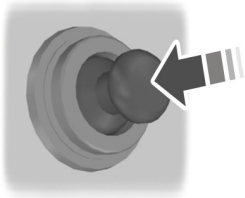

E72972

Press the element in to use the cigar lighter. It will pop out automatically.

ASHTRAY

Front ashtray

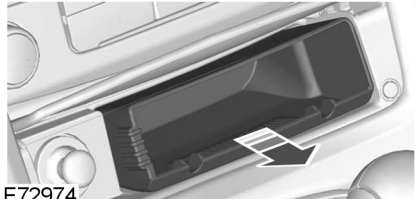

E72974

To empty, pull out the complete ashtray.

Rear ashtray

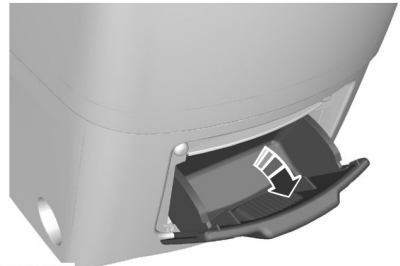

E73705

To remove the ashtray, open it, press it down against the spring and remove it.

AUXILIARY POWER POINTS

CAUTION

- ! If you use the socket when the engine is not running, the battery may discharge.

Note: You can use the socket when the ignition is switched off.

Convenience features

Note: You can use the socket to power 12 volt appliances that have a maximum current rating of 15 Amperes. Use only Ford accessory connectors or connectors specified for use with SAE standard sockets.

S-Max



E74130

Galaxy



E72977

CUP HOLDERS

WARNING



Do not place hot drinks in the cup holders when the vehicle is moving.

Seat back trays

WARNING



Do not use the trays when the vehicle is moving. Make sure that you secure the trays in the lowered position before setting off.

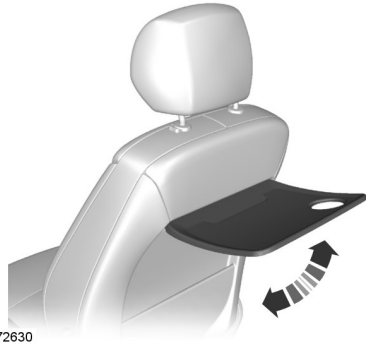

E72630

GLOVE BOX

Cooled glove box

Note: You can cool the glove box using air from the air conditioning system.

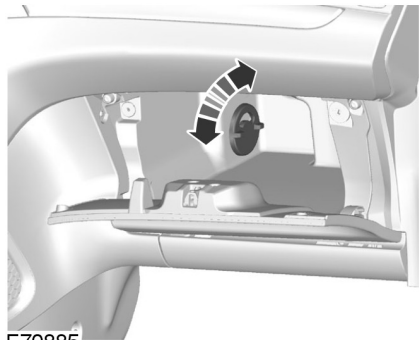

E70885

Convenience features

STORAGE COMPARTMENTS

WARNING

 Do not drive with any storage compartment lid open. Make sure that you secure the lid before setting off.

CAUTION

 Do not keep heat-sensitive items and liquids in any storage compartment.

Front storage compartments

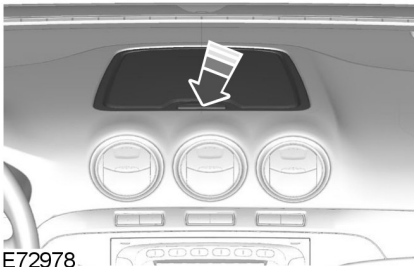

E72978



E73704



E72905

Under seat storage compartment

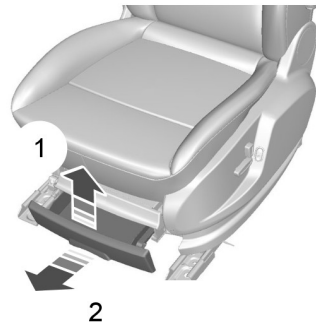

E72981

Overhead storage compartments

WARNING

 Do not place heavy objects in the overhead storage compartments.

CAUTION

 Do not exceed the maximum permissible loads of 1 kilogramme (2.2 pounds) for the smaller compartment and 2 kilogrammes (4.4 pounds) for the larger compartment.

Convenience features

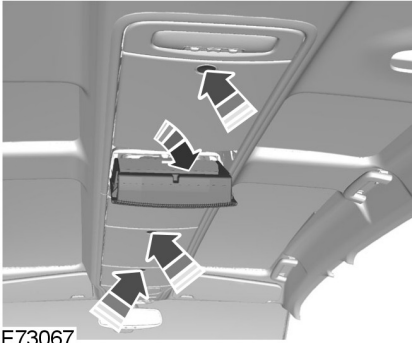

E73067

Under floor storage compartment

WARNING

 If you want to use a child seat with a support leg, consult the child seat manufacturer's website or fitting instructions. You must make sure the child seat is compatible with your vehicle. Check for any special fitting instructions regarding the removal of the under floor storage compartment cover or the position of the second row seats. See **Child Seat Positioning** (page 23).

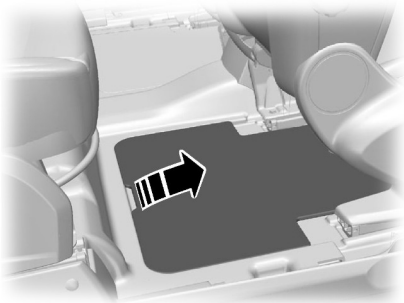

E72585

Vehicles with Premium sound system

CAUTION

 Do not attempt to open the left-hand cover.

MAP POCKETS

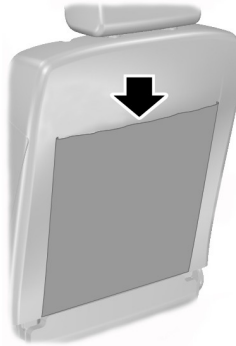

E74686

SEAT BACK TRAYS

WARNING

 Do not use the trays when the vehicle is moving. Make sure that you secure the trays in the lowered position before setting off.

Convenience features

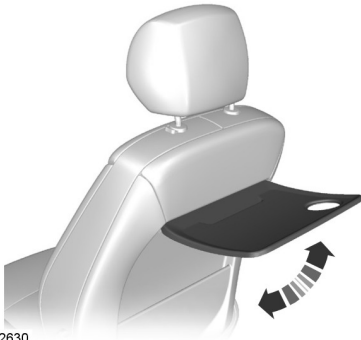

E72630

GLASSES HOLDER

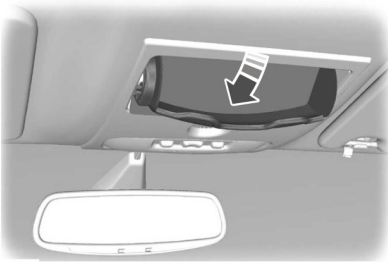

E75193

MEMORY FUNCTION

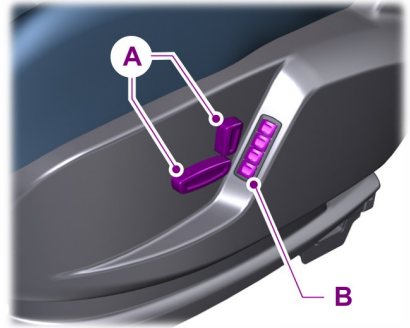

E86768

- A Seat adjustment controls
- B Memory pre-set buttons

Up to four different driver's seat and exterior mirror positions can be stored in the memory. Your preferred setting for the reverse mirror dipping feature can also be stored.

Setting a memory pre-set

Passive setting

The vehicle stores the seating and mirror positions for up to four remote controls or passive keys. Next time the vehicle is unlocked, the position of the seat and mirrors will adjust to the last used position.

Each time you turn the ignition off, the current seat and mirror settings are stored on the remote control or passive key used.

Active setting

1. Turn the ignition on.
2. Adjust the seat and exterior mirrors to the desired position.

Convenience features

3. Press and hold the desired pre-set button **B** until a single chime sounds to confirm.

Recalling a stored seat position

Note: *To stop seat movement during a recall, press any driver seat adjustment control, any of the memory buttons or any mirror control switch. Seat movement will also stop if you move the vehicle.*

Passive recall

Note: *If more than one passive key is in range, the memory function will move to the settings of the first key stored.*

When you unlock the vehicle with the remote control or pull the driver door handle with a passive key in range, the seat and mirrors will move to the position stored on that remote control or passive key.

Active recall

Press the pre-set button associated with the desired driving position. The seat and mirrors will move to the position stored on that pre-set.

Resetting the memory

If any seat position travel is interrupted (e.g. an obstacle in the way or loss of power supply), you will need to reset the memory.

Note: *Make sure all electrical accessories are switched off.*

1. Turn the ignition to position **II**.
2. Operate the seat adjustment control to move the seat in the required direction until it stops. A click will be heard.

3. Release the seat adjustment control and immediately press and hold the switch in the same direction for at least 3 seconds. Keep it held until the seat stops at the mechanical end of its travel and a click is heard.
4. Release the seat adjustment control.
5. Operate the same seat adjustment control in the opposite direction for at least 3 seconds. Keep it held until the seat stops at the mechanical end of its travel and a click is heard.

CHILDINDER MIRROR



E75192

CD CHANGER

This is located under the front passenger seat.

AUXILIARY INPUT SOCKET

You can find the socket in the glove box or the centre console. See **Auxiliary input (AUX IN) socket** (page 291).

Convenience features

USB PORT

You can find the socket in the glove box or the centre console. See **Connectivity** (page 318).

Starting and Stopping the Engine

GENERAL INFORMATION

General points on starting

If the battery has been disconnected the vehicle may exhibit some unusual driving characteristics for approx. 8 kilometres (5 miles) after reconnecting the battery.

This is because the engine management system must realign itself with the engine. Any unusual driving characteristics during this period may be disregarded.

Starting the engine by towing or pushing

WARNING



To prevent damage you must not push or tow start your vehicle. Use booster cables and a booster battery.

See **Jump-Starting the Vehicle** (page 251).

IGNITION SWITCH

WARNING



Never return the key to position **0** or **I** when the vehicle is in motion.



E72128

0 The ignition is off.

I The ignition and all main electrical circuits are disabled.

Note: Do not leave the ignition key in this position for too long to avoid discharging the battery.

II The ignition is switched on. All electrical circuits are operational. Warning lamps and indicators illuminate. This is the key position when driving. You must also select it when being towed.

III The starter motor is activated. Release the key as soon as the engine starts.

KEYLESS STARTING

WARNINGS



The keyless starting system may not function if the key is close to metal objects or electronic devices such as mobile phones.



Always check that the steering wheel lock is deactivated before attempting to move your vehicle.

See **Steering Wheel Lock** (page 146).

Note: The ignition may automatically switch off after a period of time if your vehicle has been left unattended with the ignition on. This is to prevent the vehicle battery from discharging.

Note: A valid passive key must be located inside the vehicle to switch the ignition on and start the engine.

Note: To start your engine you must also fully depress the brake or clutch pedal, depending on the transmission fitted.



E85766

Starting and Stopping the Engine

Ignition on

Press the button once. All electrical circuits are operational, warning lamps and indicators illuminate.

Starting with manual transmission

Note: *Releasing the clutch pedal during engine start will stop the engine cranking and return to ignition on.*

1. Fully depress the clutch pedal.
2. Briefly press the button.
3. If the engine does not start, fully depress the brake and clutch pedals.

Starting with automatic transmission

Note: *Releasing the brake pedal during engine start will stop the engine cranking and return to ignition on.*

1. Move the transmission selector lever to position P or N.
2. Fully depress the brake pedal.
3. Briefly press the button.

Starting a diesel engine

Note: *Engine cranking may not commence until the engine glow plug cycle has been completed. This may take several seconds in extremely cold conditions.*

Note: *Continue to press the clutch or brake pedal until engine cranking begins.*

Failure to start

The passive starting system will not function if:

- The passive key frequencies are jammed.
- The passive key battery is flat.

If you are unable to start your vehicle carry out the following procedure.

Type 1



E87382

1. Hold the key next to the steering column shroud exactly as shown.
2. With the key in this position you can use the button to switch the ignition on and start your vehicle.

Type 2

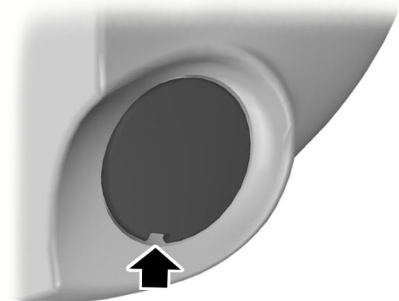

E87381

1. Carefully prise out the cover.

Starting and Stopping the Engine

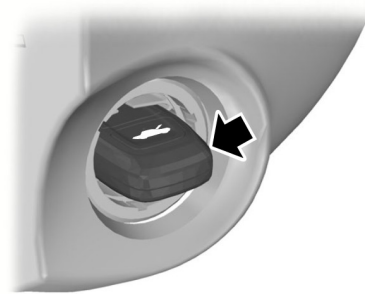

E85767

2. Insert the key into the key holder.



E85766

3. With the key in this position you can press the button to switch the ignition on and start your vehicle.

Stopping the engine with the vehicle stationary

Note: *The ignition, all electrical circuits, warning lamps and indicators will be switched off.*

Manual transmission

Briefly press the button.

Automatic transmission

1. Move the transmission selector lever to position P.
2. Briefly press the button.

Stopping the engine when the vehicle is moving

WARNING

 Switching off the engine when the vehicle is still moving will result in a loss of brake and steering assistance. The steering will not be locked, but higher effort will be required. When the ignition is switched off some electrical circuits, warning lamps and indicators may also be OFF.

Press and hold the button for two seconds, or press three times within three seconds.

STEERING WHEEL LOCK

WARNING

 Always check that the steering is unlocked before attempting to move your vehicle.

Vehicles without keyless starting

To activate the steering wheel lock;

1. Remove the key from the ignition switch.
2. Turn the steering wheel.

Vehicles with keyless starting

Note: *The steering wheel lock will not activate when the ignition is on or the vehicle is moving.*

Your vehicle has an electronically controlled steering wheel lock. This operates automatically.

The steering wheel lock will activate after a short period of time once you have parked your vehicle and the passive key is outside of the vehicle.

Starting and Stopping the Engine

Deactivating the steering wheel lock

Switch the ignition on, or:

Vehicles with automatic transmission

- Press the brake pedal.

Vehicles with manual transmission

- Press the clutch pedal.

STARTING A PETROL ENGINE

Note: *You can only operate the starter for a limited period of time, for example 10 seconds. The number of start attempts is limited to approximately six. If you exceed this limit, the system will not allow you to try again until a period of time has elapsed, for example 30 minutes.*

Cold or hot engine

Vehicles with manual transmission

Note: *Do not touch the accelerator pedal.*

Note: *Releasing the clutch pedal during engine start may stop the engine cranking and return to ignition on.*

1. Fully depress the clutch pedal.
2. Start the engine.

Vehicles with automatic transmission

Note: *Do not touch the accelerator pedal.*

Note: *Releasing the brake pedal during engine start may stop the engine cranking and return to ignition on.*

1. Move the transmission selector lever to position P or N.
2. Fully depress the brake pedal.
3. Start the engine.

All vehicles

If the engine does not start, wait for a short period and try again.

If the engine does not start after three attempts, wait 10 seconds and follow the flooded engine procedure.

If you have difficulty starting the engine when the temperature is below -25°C (-13°F), press the accelerator pedal to the mid-way point of its travel and try again.

Flooded engine

Vehicles with manual transmission

1. Fully depress the clutch pedal.
2. Fully depress the accelerator pedal and hold it there.
3. Start the engine.

Vehicles with automatic transmission

1. Move the transmission selector lever to position P or N.
2. Fully depress the accelerator pedal and hold it there.
3. Fully depress the brake pedal.
4. Start the engine.

All vehicles

If the engine does not start, repeat the cold or hot engine procedure.

Engine idle speed after starting

The speed at which the engine idles immediately after starting will vary depending on the engine temperature.

The idle speed is automatically increased when the engine is cold this is to heat the catalytic converter. This keeps the vehicle emissions to an absolute minimum.

The idle speed will slowly decrease to the normal level as the catalytic converter warms up.

Starting and Stopping the Engine

STARTING A PETROL ENGINE - E85

For general information on starting a petrol engine. See **Starting a Petrol Engine** (page 147).

Starting at low ambient temperatures

When the temperature is lower than -10°C (14°F) and the vehicle is filled with E85, an engine block heater should be used to facilitate starting. See **Engine Block Heater** (page 149). Failure to do this will result in a non start.

If the temperature is expected to remain below -10°C (14°F), it is recommended that you increase the proportion of petrol in the tank by topping up with 95 octane unleaded petrol if the tank is not already full. About 10 litres (2.2 gallons) of petrol will reduce the proportion of E85 in a $\frac{3}{4}$ full tank from 85% to 70% and will considerably improve cold start capability.

If, at very low temperatures, the tank is filled with only E85 and there is no way to use an engine block heater, you may experience difficulties starting the engine.

If the engine fails to start, proceed as follows:

1. Fully depress the accelerator pedal.
2. Turn the ignition key to position III.

CAUTION



Release the ignition key as soon as the engine has started.

3. Gradually release the accelerator pedal after five seconds of engine cranking or as the engine speed rises.

If the engine fails to start, repeat steps 1, 2 and 3, or connect an engine block heater for two hours before attempting another start.

During starting, the fuel injectors are turned off as long as the accelerator pedal is depressed. This can be used to drain excessive fuel from the intake manifold after several unsuccessful starting attempts.

If the battery has been disconnected or after the fuel type has been changed, the idle speed may be irregular. This will improve after 10 to 30 seconds.

STARTING A DIESEL ENGINE

Cold or hot engine

All vehicles

Note: When the temperature is below -15°C (5°F), you may need to crank the engine for up to 25 seconds.

Note: Continue cranking the engine until it starts.

Note: You can only operate the starter for a maximum of 30 seconds at a time.



Switch the ignition on and wait until the glow plug indicator goes off.

Vehicles with manual transmission

Note: Do not touch the accelerator pedal.

1. Fully depress the clutch pedal.
2. Start the engine.

Vehicles with automatic transmission

1. Select park or neutral.
2. Fully depress the brake pedal.
3. Start the engine.

Starting and Stopping the Engine

DIESEL PARTICULATE FILTER

The DPF forms part of the emissions reduction systems fitted to your vehicle. It filters harmful diesel particulates (soot) from the exhaust gas.

Regeneration

WARNING



Do not park or idle your vehicle over dry leaves, dry grass or other combustible materials. The DPF regeneration process creates very high exhaust gas temperatures and the exhaust will radiate a considerable amount of heat during and after DPF regeneration, and after you have switched the engine off. This is a potential fire hazard.

CAUTION



Avoid running out of fuel.

Note: *During regeneration at low speed or engine idle, you may smell a hot metallic odour and could notice a clicking metallic sound. This is due to the high temperatures reached during regeneration and is normal.*

Note: *After you have switched your engine off the fans may continue to run for a short period of time.*

Unlike a normal filter which requires periodic replacement, the DPF has been designed to regenerate, or clean itself to maintain operating efficiency. The regeneration process takes place automatically. However, some driving conditions mean that you may need to support the regeneration process.

If you drive only short distances or your journeys contain frequent stopping and starting, where there is increased acceleration and deceleration, occasional trips with the following conditions will assist the regeneration process:

- Drive your vehicle at a constant speed, preferably on a main road or motorway, for up to 20 minutes.
- Avoid prolonged idling and always observe speed limits and road conditions.
- Do not switch off the ignition.
- Use a lower gear than normal to maintain a higher engine speed during this journey, where appropriate.

SWITCHING OFF THE ENGINE

Vehicles with a turbocharger

CAUTION



Do not switch the engine off when it is running at high speed. If you do, the turbocharger will continue running after the engine oil pressure has dropped to zero. This will lead to premature turbocharger bearing wear.

Release the accelerator pedal. Wait until the engine has reached idle speed and then switch it off.

ENGINE BLOCK HEATER

CAUTION



Make sure you disconnect the power cable from the engine heater connector before driving away.

Note: *The engine heater connector is located in the radiator grille at the front of your vehicle.*

Starting and Stopping the Engine

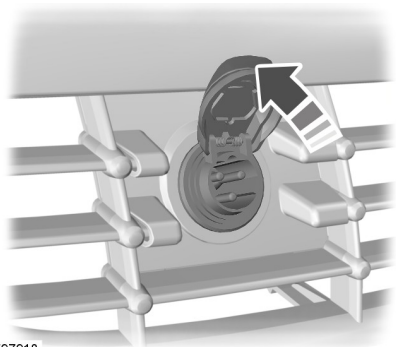

E97918

Connect the engine heater for 2 to 3 hours before starting the engine.

Start-Stop

PRINCIPLE OF OPERATION

CAUTION

 For vehicles with Start-stop the battery requirement is different. It must be replaced by one of exactly the same specification as the original.

The system reduces fuel consumption and CO2 emissions by shutting down the engine when the vehicle is idling, for example at traffic lights. The engine will automatically restart when the driver presses the clutch pedal or when required by a vehicle system, for example to recharge the battery.

To obtain maximum benefit from the system, move the gear lever to the neutral position and release the clutch pedal during any stop of longer than three seconds.

USING START-STOP

WARNINGS

 The engine may restart automatically if required by the system. See **Principle of Operation** (page 151).

 Switch the ignition off before opening the bonnet or carrying out any maintenance.

 Always switch the ignition off before leaving your vehicle, as the system may have shut down the engine but the ignition will still be live.

Note: *The system only operates when the engine is warm and the outside temperature is between 0°C (32°F) and 30°C (86°F).*

Note: *If you stall the engine, and then depress the clutch pedal within a couple of seconds, the system will automatically restart the engine.*

Note: *The Start-stop indicator will illuminate green when the engine shuts down. See **Warning Lamps and Indicators** (page 84).*

Note: *The Start-stop indicator will flash amber, requiring you to select neutral or depress the clutch pedal. In conjunction a message will be shown in the display.*

Note: *If the system detects a malfunction, it is deactivated. Have the system checked by a properly trained technician.*

Note: *If you have switched the system off, the switch will be illuminated.*

Note: *The system is on by default. To switch the system off, press the switch in the instrument panel. The system will only be de-activated for the current ignition cycle. To turn it on, press the switch again. For item location. See **At a Glance** (page 9).*



To stop the engine

1. Stop the vehicle.
2. Move the gear lever to the neutral position.
3. Release the clutch pedal.
4. Release the accelerator pedal.

The system may not shut down the engine under certain conditions, for example:

- To maintain the interior climate.
- Low battery voltage.
- The outside temperature is too low or too high.
- The driver's door has been opened.

Start-Stop

- Low engine operating temperature.
- Low brake system vacuum.
- If a road speed of 5 km/h (3 mph) has not been exceeded.
- The driver's seat belt has not been fastened.

To re-start the engine

Note: *The gear lever must be in the neutral position.*

Depress the clutch pedal.

The system may automatically restart the engine under certain conditions, for example:

- Low battery voltage.
- To maintain the interior climate.

Eco Mode

PRINCIPLE OF OPERATION

The system assists the driver to drive more efficiently by constantly monitoring characteristics of gear changing, anticipation of traffic conditions and speeds on motorways and open roads.

Note: *These efficiency values do not result in a defined fuel consumption figure. It might vary as it is not only related to these driving disciplines but also influenced by many other factors such as short journeys and cold starts.*

Note: *Frequent short journeys, where the engine does not fully warm up, will also increase fuel consumption.*

The value of these characteristics is represented by petals shown in the display, with five petals being the most efficient. The more efficiently you drive, the better the rating, and the better your overall fuel consumption.

Type 1

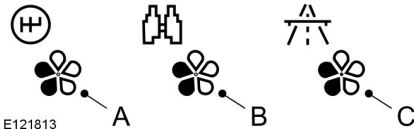

- A Gear shifting
- B Anticipation
- C Efficient speed

Gear shifting

Using the highest drivable gear appropriate for the road conditions will improve fuel consumption.

Anticipation

Adjusting your vehicle speed and the distance to other vehicles without the need for heavy braking or acceleration will improve fuel consumption.

Efficient speed

Higher speeds use more fuel. Reducing your cruising speed on open roads will improve fuel consumption.

Type 2 and 3

The relevant information will be shown in the display.

USING ECO MODE

The system is accessed using the relevant information display menu. See **Information Displays** (page 88).

Resetting Eco mode

Reset the average fuel consumption.

Note: *New values may take a short time to calculate.*

Fuel and Refuelling

SAFETY PRECAUTIONS

WARNINGS

 Stop refuelling after the fuel nozzle stops the second time. Additional fuel will fill the expansion space in the fuel tank which could lead to fuel overflowing. Fuel spillage could be hazardous to other road users.

 Do not use any kind of flames or heat near the fuel system. The fuel system is under pressure. There is a risk of injury if the fuel system is leaking.

FUEL QUALITY - PETROL

CAUTION

 Do not use leaded petrol or petrol with additives containing other metallic compounds (e.g. manganese-based). They could damage the emission system.

Note: *We recommend that you use only high quality fuel without additives or other engine treatments.*

Use minimum 95 octane unleaded petrol that meets the specification defined by EN 228, or the equivalent national specification.

Your vehicle is suitable for use with ethanol blends up to 10% (E5 and E10).

FUEL QUALITY - E85

WARNINGS

 Do not modify the fuel system configuration or the components in the system.

 Do not replace the fuel system or the components with parts not specially designed to be used with E85.

CAUTIONS

 Do not use leaded petrol or petrol with additives containing other metallic compounds (e.g. manganese-based). They could damage the emission system.

 Do not use methanol instead of E85.

Note: *We recommend that you use only high quality fuel without additives or other engine treatments.*

Note: *When using E85, you may experience a higher fuel consumption.*

Note: *Your vehicle will operate well on commercial quality 95 octane unleaded petrol, but only high quality E85 offers the same protection and performance.*

Use **minimum 95 octane unleaded** petrol that meets the specification defined by **EN 228**, or equivalent. You can also use a mixture of unleaded petrol and E85.

Long-term storage

Due to small amounts of corrosive impurities that may be found in the E85, it is recommended that you fill the tank with only 95 octane unleaded petrol prior to long-term storage of your vehicle.

FUEL QUALITY - DIESEL

WARNING

 Do not mix diesel with oil, petrol or other liquids. This could cause a chemical reaction.

CAUTIONS

 Do not add kerosene, paraffin or petrol to diesel. This could cause damage to the fuel system.

Fuel and Refuelling

CAUTIONS

- ⚠ Use diesel that meets the specification defined by **EN 590**, or the relevant national specification.

Note: We recommend that you use only high quality fuel.

Note: The use of additives or other engine treatments not approved by Ford is not recommended.

Note: We do not recommend the prolonged use of additives intended to prevent fuel waxing.

Long-term storage

Most diesel fuels contain bio-diesel, it is recommended to fill the tank with purely mineral diesel (where available) or add an anti-oxidant prior to long-term storage of your vehicle exceeding two months. Your dealer can help you with a suitable anti-oxidant.

CATALYTIC CONVERTER

WARNING

- ⚠ Do not park or idle your vehicle over dry leaves, dry grass or other combustible materials. The exhaust will radiate a considerable amount of heat during use, and after you have switched the engine off. This is a potential fire hazard.

Driving with a catalytic converter

CAUTIONS

- ⚠ Avoid running out of fuel.
- ⚠ Do not crank the engine for long periods.
- ⚠ Do not run the engine when a spark plug lead is disconnected.

CAUTIONS

- ⚠ Do not push-start or tow-start your vehicle. Use booster cables. See **Jump-Starting the Vehicle** (page 251).
- ⚠ Do not switch the ignition off when driving.

FUEL FILLER FLAP

WARNINGS

- ⚠ Take care when refuelling to avoid spilling any residual fuel from the fuel nozzle.
- ⚠ Do not use any kind of flames or heat near the fuel system. The fuel system is under pressure. There is a risk of injury if the fuel system is leaking.

CAUTION

- ⚠ If you use a high pressure spray to wash your vehicle, only spray the fuel filler flap briefly from a distance not less than 200 millimetres (8 inches).

Note: Central locking also locks and unlocks the fuel filler flap. See **Locking and Unlocking** (page 37).

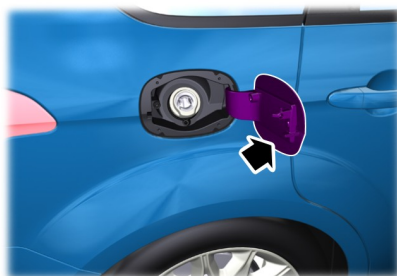

E86613

1. Press the flap to open it. Open the flap fully until it engages.

Fuel and Refuelling

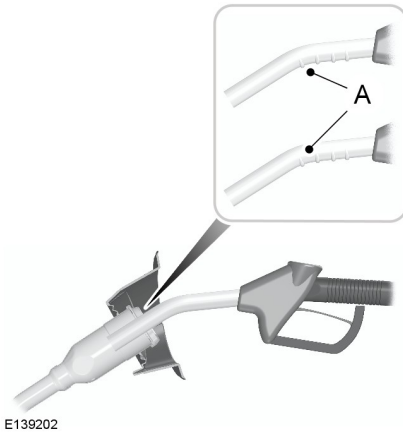

Note: When you insert the fuel nozzle, a spring loaded inhibitor will open if the correct size nozzle is detected. This helps to avoid filling up with the wrong fuel.

2. Insert the fuel nozzle up to and including the first notch on the nozzle
A. Keep it resting on the cover of the fuel pipe opening.

WARNING



Stop refuelling after the fuel nozzle stops the second time. Additional fuel will fill the expansion space in the fuel tank which could lead to fuel overflowing. Fuel spillage could be hazardous to other road users.

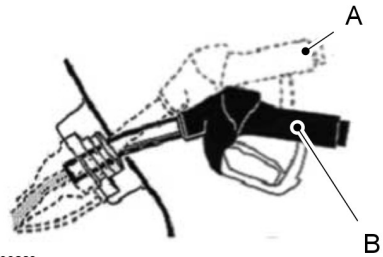

- A Incorrect position
B Correct position

3. Do not lift the nozzle during refuelling. This can affect the flow of fuel and shut off of the fuel nozzle before the fuel tank is full.

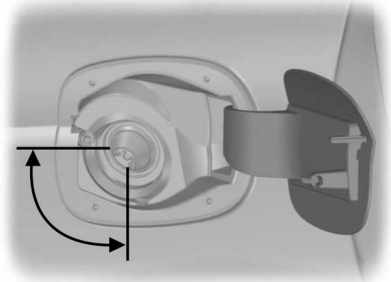

4. Operate the nozzle within the area shown.

WARNINGS



We recommend that you remove the fuel nozzle slowly to allow any residual fuel to drain into the fuel tank. Alternatively you can wait 10 seconds before removing the fuel nozzle.



Do not remove the nozzle from its fully inserted position during the entire refuelling process.

Fuel and Refuelling

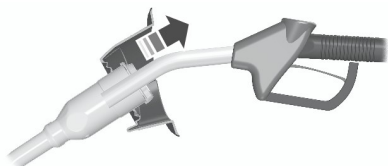

E119081

5. Slightly raise the fuel nozzle to remove it.

Refuelling with a fuel can

Use the funnel which is located in the underfloor storage compartment behind the front seats. See **Storage compartments** (page 139).

REFUELLING

CAUTION

! Do not attempt to start the engine if you have filled the fuel tank with the incorrect fuel. This could damage the engine. Have the system checked by a properly trained technician immediately.

TECHNICAL SPECIFICATIONS

REFUELLING - E85

CAUTION

! Do not attempt to start the engine if you have filled the fuel tank with the incorrect fuel. This could damage the engine. Have the system checked by a properly trained technician immediately.

After refuelling, allow 5 minutes of normal engine operation above 48 km/h (30 mph) to reduce the risk of an increased engine restart time.

FUEL CONSUMPTION

The CO₂ and fuel consumption figures are derived from laboratory tests according to EEC Directive 80/1268/EEC and subsequent amendments and are carried out by all vehicle manufacturers.

They are intended as a comparison between makes and models of vehicles. They are not intended to represent the real world fuel consumption you may get from your vehicle. Real world fuel consumption is governed by many factors including; driving style, high speed driving, stop/start driving, air conditioning usage, the accessories fitted and towing etc.

Your Ford dealer can give you advice on improving your fuel consumption.

Fuel and Refuelling

S-MAX

Fuel Consumption Figures

Variant	Urban	Extra-Urban	Combined	CO2 Emissions
	l/100 km (mpg)	l/100 km (mpg)	l/100 km (mpg)	g/km
1.6L EcoBoost (118kW/160PS), 6-speed manual transmission	9.4 (30.1)	5.7 (49.6)	7 (40.4)	164
2.0L Duratec-HE Stage IV (107kW/145PS), 5-speed manual transmission	11 (25.7)	6.4 (44.1)	8.1 (34.9)	194
2.0L Duratec-HE Stage V (107kW/145PS), 5-speed manual transmission	11.3 (25)	6.4 (44.1)	8.2 (34.4)	189
2.0L EcoBoost (149kW/203PS), 6-speed manual transmission	11.2 (25.2)	6.4 (44.1)	8.1 (34.9)	188
2.0L EcoBoost (177kW/240PS), 6-speed manual transmission	11.2 (25.2)	6.4 (44.1)	8.1 (34.9)	188
2.0L EcoBoost (149kW/203PS), 6-speed automatic transmission	11 (25.7)	6.4 (44.1)	8.1 (34.9)	189
2.0L EcoBoost (177kW/240PS), 6-speed automatic transmission	11.5 (24.6)	6.5 (43.5)	8.3 (34)	194
2.3L Duratec-HE (118kW/160PS), 6-speed automatic transmission	13.7 (20.6)	7.4 (38.2)	9.7 (29.1)	232
1.6L Duratorq-TDCi (85kW/115PS), 6-speed manual transmission without start-stop	6.2 (45.6)	5 (56.5)	5.4 (52.3)	144
1.6L Duratorq-TDCi (85kW/115PS), 6-speed manual transmission with start-stop	5.9 (47.9)	4.9 (57.6)	5.2 (54.3)	139

Fuel and Refuelling

Variant	Urban	Extra-Urban	Combined	CO2 Emissions
	l/100 km (mpg)	l/100 km (mpg)	l/100 km (mpg)	g/km
2.0L Duratorq-TDCi -DW Stage IV (103kW/140PS), Durashift 6-speed manual transmission	7.7 (36.7)	5 (56.5)	6 (47.1)	159
2.0L Duratorq-TDCi -DW Stage V, Durashift 6-speed manual transmission	6.7 (42.2)	4.7 (60.1)	5.4 (52.3)	143
2.0L Duratorq-TDCi -DW Stage IV (103kW/140PS), 6-speed automatic transmission	9.7 (29.1)	5.7 (49.6)	7.2 (39.2)	189
2.0L Duratorq-TDCi -DW Stage V (120kW/163PS), 6-speed automatic transmission	7.4 (38.2)	5.2 (54.3)	6 (47.1)	159
2.2L Duratorq-TDCi -DW Stage IV (129kW/175PS), Durashift 6-speed manual transmission	8.9 (31.7)	5.2 (54.3)	6.6 (42.8)	174
2.2L Duratorq-TDCi -DW (147kW/200PS)	8.2 (34.4)	5.7 (49.6)	6.6 (42.8)	174

Fuel and Refuelling

Galaxy

Fuel Consumption Figures

Variant	Urban	Extra-Urban	Combined	CO2 Emissions
	l/100 km (mpg)	l/100 km (mpg)	l/100 km (mpg)	g/km
1.6L EcoBoost (118kW/160PS), 6-speed manual transmission	9.7 (29)	5.8 (48.7)	7.2 (39.2)	169
2.0L Duratec-HE Stage IV (107kW/145PS), 5-speed manual transmission	11.2 (25.2)	6.5 (43.5)	8.2 (34.4)	197
2.0L Duratec-HE Stage V (107kW/145PS), 5-speed manual transmission	11.3 (25)	6.4 (44.1)	8.2 (34.4)	189
2.0L EcoBoost (149kW/203PS), 6-speed automatic transmission	11 (25.7)	6.4 (44.1)	8.1 (34.9)	189
2.3L Duratec-HE -MI4 (118kW/160PS), 6-speed automatic transmission	13.8 (20.5)	7.5 (37.7)	9.8 (28.8)	235
1.6L Duratorq-TDCi Stage V (85kW/115PS), 6-speed manual transmission without start-stop	6.2 (45.6)	5 (56.5)	5.4 (52.3)	144
1.6L Duratorq-TDCi Stage V (85kW/115PS), 6-speed manual transmission with start-stop	5.9 (47.9)	4.9 (57.6)	5.2 (54.3)	139
2.0L Duratorq-TDCi Stage IV (103kW/140PS), Durashift 6-speed manual transmission	7.7 (36.7)	5 (56.5)	6 (47.1)	159
2.0L Duratorq-TDCi Stage V, Durashift 6-speed manual transmission	6.7 (42.2)	4.7 (60.1)	5.4 (52.3)	143

Fuel and Refuelling

Variant	Urban	Extra-Urban	Combined	CO2 Emissions
	l/100 km (mpg)	l/100 km (mpg)	l/100 km (mpg)	g/km
2.0L Duratorq-TDCi Stage IV (100kW/140PS), 6-speed automatic transmission	9.7 (29.1)	5.7 (49.6)	7.2 (39.2)	189
2.0L Duratorq-TDCi Stage V (120kW/163PS), 6-speed automatic transmission	7.4 (38.2)	5.2 (54.3)	6 (47.1)	159
2.2L Duratorq-TDCi -DW Stage IV (129kW/175PS), Durashift 6-speed manual transmission	9.1 (31)	5.3 (53.3)	6.7 (42.2)	179
2.2L Duratorq-TDCi -DW (147kW/200PS)	8.4 (33.6)	5.8 (48.7)	6.8 (41.5)	179

Transmission

MANUAL TRANSMISSION

CAUTION

 Do not engage reverse gear when the vehicle is moving. This can cause damage to the transmission.

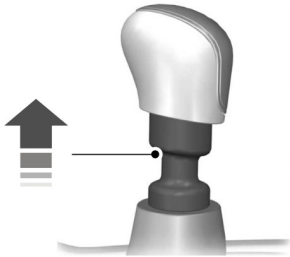

E99067

On some vehicles it is necessary to raise the collar whilst selecting reverse gear.

AUTOMATIC TRANSMISSION

Selector lever positions



E80836

- P Park
- R Reverse

- N Neutral
- D Drive
- S Sport mode and manual shifting

WARNING

 Apply the brakes before moving the selector lever and keep them applied until you are ready to move off.

Note: A cold engine has a higher idle speed. This will increase the tendency for your vehicle to **creep** when you have selected a drive gear.

Press the button on the selector lever to select reverse and park.

The selector lever position will be shown in the information display.

Park

WARNINGS

 Select park only when your vehicle is stationary.

 **Apply the parking brake and select park before leaving your vehicle.** Make sure that the selector lever is latched in position.

Note: An audible warning will sound if you open the driver's door and you have not selected park.

In this position, power is not transmitted to the drive wheels and the transmission is locked. You can start the engine with the selector lever in this position.

Reverse

WARNING

 Select reverse only when your vehicle is stationary and the engine is at idle speed.

Transmission

Neutral

In this position, power is not transmitted to the drive wheels but the transmission is not locked. You can start the engine with the selector lever in this position.

Drive

Select drive to shift automatically through the forward gears.

Sport mode and manual shifting

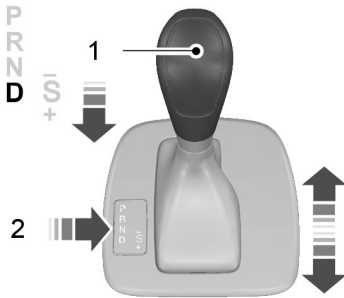

E80837

Note: A shift will occur only when the vehicle speed and the engine speed are appropriate.

Note: When you select position **S**, a gear change may occur depending on the accelerator pedal position in relation to actual vehicle speed.

Activate sport mode by moving the selector lever to position **S**. Sport mode will remain active until you shift manually up or down the gears.

Select manual shifting to shift manually through the forward gears. Push the selector lever forwards to shift down and pull it backwards to shift up.

Drive modes

The transmission will select the appropriate gear for optimum performance based on ambient temperature, road gradient, vehicle load and driver input.

Hints on driving with an automatic transmission

Moving off

1. Release the parking brake.
2. Release the brake pedal and press the accelerator pedal.

Stopping

1. Release the accelerator pedal and press the brake pedal.
2. Apply the parking brake.

Kickdown

Press the accelerator pedal fully with the selector lever in the drive position to select the next lowest gear for optimum performance. Release the accelerator pedal when you no longer require kickdown.

Emergency park position release lever

Use the lever to move the selector lever from the park position in the event of an electrical malfunction or if your vehicle has a flat battery.

Transmission

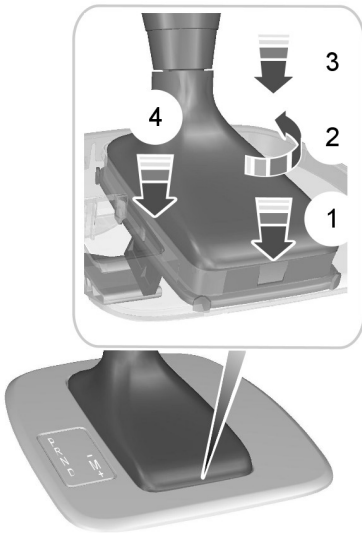

E81705

1. Insert a small flat-bladed tool into the slot.
2. Turn the tool through 90 degrees.
3. Push downwards on the tool to detach the gaiter frame from the trim panel.
4. Push downwards on the gaiter frame to release the lever and move the selector lever from the park position.
5. Pull upwards on the gaiter until the gaiter frame engages in the trim panel.

Note: *If position **P** is selected again, this procedure must be repeated.*

Brakes

PRINCIPLE OF OPERATION

Note: Depending on applicable laws and regulations in the country for which your vehicle was originally built, the brake lamps may flash if you brake heavily.

Note: Occasional brake noise is normal and often does not indicate a concern. In normal operation, the system may emit occasional or intermittent squeal or groan noises when the brakes are applied. Such noises are usually caused by environmental conditions such as cold, heat, moisture, road dust, salt or mud.

Disc brakes

Wet brake discs result in reduced braking efficiency. Dab the brake pedal when driving from a car wash to remove the film of water.

ABS

WARNING



The ABS does not relieve you of your responsibility to drive with due care and attention.

The ABS helps you to maintain full steering and directional stability when you brake heavily in an emergency, by preventing the road wheels from locking.

HINTS ON DRIVING WITH ANTI-LOCK BRAKES

Note: When the system is operating, the brake pedal will pulse and may travel further. Maintain pressure on the brake pedal. You may also hear a noise from the system. This is normal.

The ABS will not eliminate the risks when:

- you drive too close to the vehicle in front of you
- the vehicle is aquaplaning
- you take corners too fast
- the road surface is poor.

PARKING BRAKE

Applying the parking brake

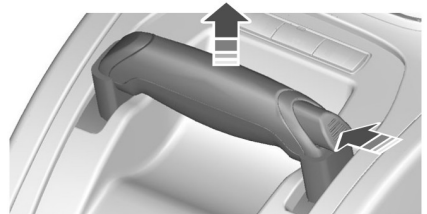
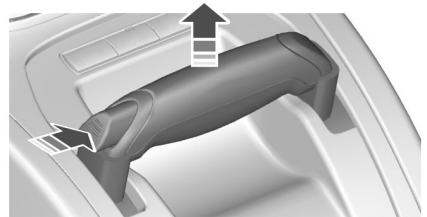

E73224

WARNING



Make sure that the parking brake is applied before you release the lever.

Note: Do not press the release button when you apply the parking brake.

Brakes

1. Press the brake pedal firmly.
2. Pull the parking brake lever upwards to its fullest extent.

Parking on a hill

If you have to park facing uphill, select first gear and turn the front wheels away from the kerb. If you have to park facing downhill, select reverse gear and turn the front wheels towards the kerb.



Releasing the parking brake

1. Press the brake pedal firmly.
2. Pull the parking brake lever upwards slightly, press the release button and push the lever downwards.

ELECTRIC PARKING BRAKE

The electric parking brake (EPB) replaces the conventional handbrake. It is operated by a switch located in the centre console.

WARNINGS

-  Always apply the EPB before leaving the vehicle.
-  Vehicles with manual transmission should always be left in first or reverse gear.
-  Vehicles with automatic transmission should always be left with the selector lever in position **P**.

Note: Under certain conditions for example on a steep hill, when the vehicle has been parked with the EPB applied, the EPB performs an automatic re-clamp function. This will occur approximately three minutes after the EPB has been applied.

Note: You may notice various noises when the EPB is applied and released. This is normal and no cause for concern.

Parking on a hill

If you have to park facing uphill, select first gear and turn the front wheels away from the kerb. If you have to park facing downhill, select reverse gear and turn the front wheels towards the kerb.

Applying the EPB



E70528

Pull up the switch once to apply the EPB.

The brake system warning lamp illuminates to confirm that the EPB is now applied.

Note: The brake system warning lamp will remain illuminated for a short period if you turn the ignition to position **O** or remove the key.

Automatic application of the EPB

WARNING

 The EPB will not automatically apply on vehicles with a keyless start or keyless entry system. You must apply the EPB using the EPB switch.

When you turn the ignition off, the cluster will remain on for several minutes.

The EPB will automatically apply when you remove the key from the ignition during this period.

Brakes

Preventing automatic application of the EPB

WARNINGS

 Do not leave the vehicle if you have not applied the EPB. Remember that if you press down the switch while removing the key from the ignition the EPB will not be applied.

 Make sure that the vehicle's wheels are securely wedged if you park the vehicle with the EPB released to prevent it from rolling away.

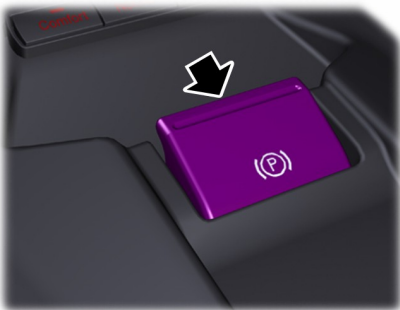

E70529

Hold the switch pressed while you switch off the ignition or while you remove the key from the ignition.

WARNING

 If you prevented the EPB from applying while turning off the ignition, it will remain off when you remove the key.

Applying the EPB when the vehicle is moving

WARNING

 With the exception of emergency conditions (for example, the brake pedal does not work or is blocked), do not apply the EPB while the vehicle is moving. On bends, on poor road surfaces or weather conditions, emergency braking can cause the vehicle to skid out of control or off the road.

If you apply the EPB while the vehicle is moving, the brake system warning lamp illuminates and a warning chime will sound.

At speeds above 6 km/h (4 mph), the braking force is applied as long as you hold the switch in the on position. The EPB will be applied until you release or press down the switch, or press the accelerator pedal further.

Releasing the EPB

Automatic release - drive away release (DAR)

Note: *On vehicles with automatic transmission, the driver's door must be closed and the driver's seatbelt must be fastened before the DAR will operate.*

Note: *If the EPB warning lamp stays illuminated the EPB will not automatically release. You must release the EPB using the EPB switch.*

Note: *The engine must be running and the accelerator pedal must be pressed before the DAR will operate.*

Note: *The clutch pedal must be fully depressed before the DAR will operate.*

Engage first or reverse gear, move off as normal using the accelerator and clutch pedals and the EPB will be automatically released.

Brakes

The brake system warning lamp will go off to confirm that the EPB has been released.

Note: *On vehicles with manual transmission, if the gear lever is in neutral when you release the clutch pedal and depress the accelerator pedal, the EPB will be released automatically.*

Note: *The EPB also makes moving off on a slope easier and prevents the vehicle from rolling in an undesired direction. The brakes are released automatically once the clutch is engaged and the engine has developed sufficient drive to prevent the vehicle from rolling down the slope. This is an advantage when pulling away on a slope, for example from a car park ramp, traffic lights or when reversing uphill into a parking space.*

Manual release

Note: *To release the EPB, the ignition must be in position II.*



E70529

Hold the brake pedal depressed and press down the switch.

The brake system warning lamp will go off to confirm that the EPB has been released.

Moving off with a trailer (vehicles with manual transmission)

Depending on the gradient and the weight of the trailer, the vehicle and trailer may roll backwards slightly when you move off on a slope. To prevent this happening, deactivate the DAR and release the EPB manually as follows:

1. Pull up the switch and hold it in this position.
2. Move off as normal and then press down the switch when you notice that the engine has developed sufficient driving force.

Cut in the power supply

WARNING



You will not be able to apply or release the EPB if there is a cut in the power supply, for example a flat battery, failure of the alternator or vehicle electronics.

If the battery is flat, use booster cables and a booster battery. See **Jump-Starting the Vehicle** (page 251).

Stability Control

PRINCIPLE OF OPERATION

Electronic stability programme (ESP)

WARNING



The system does not relieve you of your responsibility to drive with due care and attention.

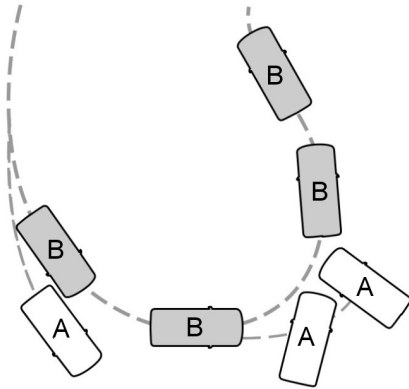

E72903

- A Without ESP
- B With ESP

The system supports stability when the vehicle starts to slide away from your intended path. This is performed by braking individual wheels and reducing engine torque as needed.

The system also provides an enhanced traction control function by reducing engine torque if the wheels spin when you accelerate. This improves your ability to pull away on slippery roads or loose surfaces, and improves comfort by limiting wheel spin in hairpin bends.

Stability control (ESP) warning lamp

While driving, it flashes during activation of the system. See **Warning Lamps and Indicators** (page 84).

Emergency brake assist

WARNING



The system does not relieve you of your responsibility to drive with due care and attention.

The system will detect when you brake heavily by measuring the rate at which you press the brake pedal. It will provide maximum braking efficiency as long as you press the pedal. The system can reduce stopping distances in critical situations.

USING STABILITY CONTROL

Note: The system will be switched on automatically every time you switch the ignition on.

Vehicles with stability control (ESP) switch



Press and hold the switch for one second. The switch will illuminate. A message will be shown in the display. See **Information Messages** (page 101).

Press the switch again to turn the system on.

For item location: See **At a Glance** (page 9).

Vehicles without stability control (ESP) switch

Turn the system off and on using the information display. See **Information Displays** (page 88).

Hill Start Assist

PRINCIPLE OF OPERATION

The system makes it easier to pull away when the vehicle is on a slope without the need to use the parking brake.

When the system is active, the vehicle will remain stationary on the slope for a short time after you release the brake pedal. During this time, you have time to move your foot from the brake to the accelerator pedal and pull away. The brakes are released automatically once the engine has developed sufficient drive to prevent the vehicle from rolling down the slope. This is an advantage when pulling away on a slope, for example from a car park ramp, traffic lights or when reversing uphill into a parking space.

WARNING



The system does not replace the parking brake. When you leave the vehicle, always apply the parking brake and select first or reverse gear.

USING HILL START ASSIST

The HLA can operate in either automatic or manual mode. If you select automatic mode, the HLA is activated automatically when the vehicle is on a slope and you press the brake pedal. If you select manual mode, you must activate the HLA using the brake pedal.

To set the HLA mode:



E70499

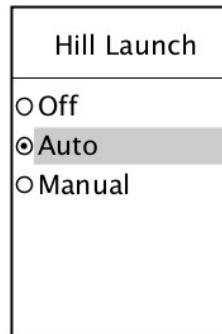

E74629

1. Press the right arrow button on the steering wheel to enter the main menu.
2. Highlight **Setup** with the up and down buttons and press the right arrow button.
3. Highlight **Hill Launch** and press the right arrow button.
4. Highlight the desired setting and press the **OK** button to confirm the setting. If **Off** is selected, the HLA is switched off and cannot be activated either automatically or manually.
5. Press the left arrow button to exit the menu. Hold the left arrow button pressed to return to the trip computer display.

Hill Start Assist

Note: When HLA is in manual activation mode, only use the HLA when pulling away uphill on gradients greater than 3%. If the vehicle is on the flat or on a downhill slope, an active HLA will make it difficult to pull away smoothly.

Activating the HLA

WARNINGS



You must remain in the vehicle once you have activated the HLA. Any attempt to leave the vehicle will deactivate the HLA automatically.



The HLA is active only if the message **Hill Launch Assist active** is displayed in the information display. During all times you are responsible for controlling the vehicle, supervising the HLA and intervening, if required.

You can activate the HLA only if the following conditions have been met:

- The engine is running.
- The HLA is switched on (automatic or manual mode).
- The parking brake or electric parking brake (EPB) is fully disengaged.
- On vehicles with manual transmission, the clutch pedal is pressed.
- On vehicles with automatic transmission, the driver's door is closed.
- No failure mode is present.

To activate the HLA in automatic mode:

1. Press the brake pedal to bring the vehicle to a complete standstill. Keep the brake pedal depressed.
2. If the sensors detect that the vehicle is on a slope and the right driving direction is selected (first gear if the vehicle is pointing uphill, reverse gear if the vehicle is pointing downhill), the HLA will be activated automatically. **Hill Launch Assist active** is displayed in the information display.
3. When you remove your foot from the brake pedal, the vehicle will remain on the slope without rolling away for approximately two to three seconds.
4. Drive off in the normal manner. The brakes will be released automatically.

To activate the HLA in manual mode:

1. Press the brake pedal to bring the vehicle to a complete standstill. Keep the brake pedal depressed.
2. Quickly jab the brake pedal further until you hear a chime and **Hill Launch Assist active** is displayed in the information display. The HLA is now active.
3. When you remove your foot from the brake pedal, the vehicle will remain on the slope without rolling away for approximately two to three seconds.
4. Drive off in the normal manner. The brakes will be released automatically.

Hill Start Assist

WARNING



When HLA is active and the system detects a malfunction, the HLA is deactivated and the message

Please use park brake! followed by **Hill Launch A .not available** is displayed in the information display. The vehicle is still safe to be driven and can be repaired during the next service. The message **Hill Launch A .not available** is also displayed in the information display with manual activation during a malfunction or if one of the activation criteria is not met. If you have switched the HLA off, no messages will be displayed.

Deactivating the HLA

To deactivate the HLA, perform **one** of the following:

- Apply the parking brake or electric parking brake (EPB) .
- Wait for two to three seconds until the HLA deactivates automatically.
- If a forward gear was selected when the HLA became active, select reverse gear.
- If reverse gear was selected when the HLA became active, select a forward gear.

Hill Launch Assist off is displayed in the information display.

Active suspension

PRINCIPLE OF OPERATION

The active suspension provides improved handling, comfort and stability by continuously adjusting the damper properties to the current road and driving conditions. This system in conjunction with the ABS system offers the benefit of potentially shorter stopping distances on rough road surfaces.

Depending on your preferences and driving style, you can choose between three different settings:

Comfort

This provides a softer driving feel.

Normal

Normal setting.

Sport

This provides a harder, sportier ride.

USING ACTIVE SUSPENSION

Selecting a setting

Note: After you select a setting, you may not immediately notice a difference in the vehicle's handling. The effect of the continuously controlled damping depends on the road surface and driving conditions.



E70475

You can change the setting while driving.

System malfunction

The active suspension system will switch off automatically if it malfunctions. The suspension will be set to a fail-safe condition that will enable you to continue driving but you will not be able to change the suspension setting. Have this checked as soon as possible.

Parking Aids

PRINCIPLE OF OPERATION

WARNING



The parking aid does not relieve you of your responsibility to drive with due care and attention.

CAUTIONS



Vehicles fitted with a trailer tow module not approved by us may not correctly detect obstacles.



The sensors may not detect objects in heavy rain or other conditions that cause disruptive reflections.



The sensors may not detect objects with surfaces that absorb ultrasonic waves.



The parking aid does not detect obstacles moving away from the vehicle. They will only be detected shortly after they start to move towards the vehicle again.



Take particular care when reversing with a tow ball arm or rear fitted accessories e.g. a bicycle carrier, as the rear parking aid will only indicate the distance from the bumper to the obstacle.



If you use a high pressure spray to wash your vehicle, only spray the sensors briefly from a distance not less than 20 centimetres (8 inches).

Note: On vehicles fitted with a tow ball arm, the parking aid is deactivated automatically when any trailer lamps (or lighting boards) are connected to the 13-pin socket via a trailer tow module we have approved.

Note: Keep the sensors free from dirt, ice and snow. Do not clean with sharp objects.

Note: The parking aid may emit false tones if it detects a signal using the same frequency as the sensors or if the vehicle is fully laden.

Note: The outer sensors may detect the side walls of a garage. If the distance between the outer sensor and the side wall remains constant for three seconds, the tone will switch off. As you continue, the inner sensors will detect rearward objects.

PARKING AID

Switching the parking aid on and off

Note: The parking aid switches off automatically when you start the engine or when you exceed 16 km/h (10 mph).

Note: The front and rear sensors are always activated or deactivated together.

The parking aid is per default off. To switch the parking aid on, press the switch in the instrument panel or select reverse gear.

The light in the switch illuminates when the parking aid is activated.

To turn it off, press the switch again.

Manoeuvring with the parking aid

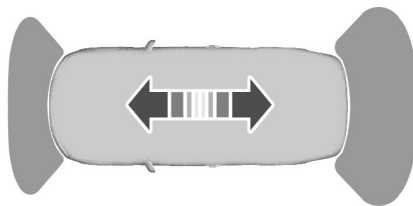

E72902

Note: If a high pitch warning tone sounds for three seconds and the light in the switch is flashing, it indicates a malfunction. The system will be disabled. Have the system checked by properly trained technicians.

Parking Aids

You will hear an intermittent tone at a distance of up to approximately 150 centimetres (59 inches) between the obstacle and rear bumper, 80 centimetres (31 inches) between the obstacle and front bumper and 50 centimetres (20 inches) to the side. Decreasing the distance accelerates the intermittent tone. A continuous tone will start at a distance of less than 30 centimetres (12 inches).

You will hear an alternating tone from the front and rear if obstacles are closer than 30 centimetres (12 inches) to the front and rear bumpers.

Rear view camera

PRINCIPLE OF OPERATION

The camera is a visual aid for use when reversing.

WARNING



The system does not relieve you of your responsibility to drive with due care and attention.

CAUTIONS



If you use a high pressure spray to wash your vehicle, only spray the camera briefly from a distance not less than 20 centimetres (8 inches).



Do not apply pressure to the camera.

Note: *Keep the camera free from dirt, ice and snow. Do not clean with sharp objects, degreaser, wax or organic products. Use only a soft cloth.*

During operation, guide lines appear in the display which represent your vehicle's path and approximate distance from rearward objects.

REAR VIEW CAMERA

WARNINGS



The operation of the camera may vary depending on the ambient temperature, vehicle and road conditions.



The distances shown in the display may differ from the actual distance.



Do not place objects in front of the camera.

The camera is located on the luggage compartment lid near the handle.

S-MAX



E99105

Galaxy



E124349

Activating the rear view camera

CAUTION



The camera may not detect objects that are close to the vehicle.

With the ignition and the audio unit switched on, engage reverse gear. The image is displayed on the screen.

Rear view camera

The camera may not operate correctly in the following conditions:

- Dark areas.
- Intense light.
- If the ambient temperature increases or decreases rapidly.
- If the camera is wet, for example in rain or high humidity.
- If the camera's view is obstructed, for example by mud.

Using the display

CAUTIONS

- ! Obstacles above the camera position will not be shown. Inspect the area behind your vehicle if necessary.
- ! Marks are for general guidance only, and are calculated for vehicles in maximum load conditions on an even road surface.

The lines show a projected vehicle path (based on the current steering wheel angle) and the distance from the exterior mirrors and rear bumper.

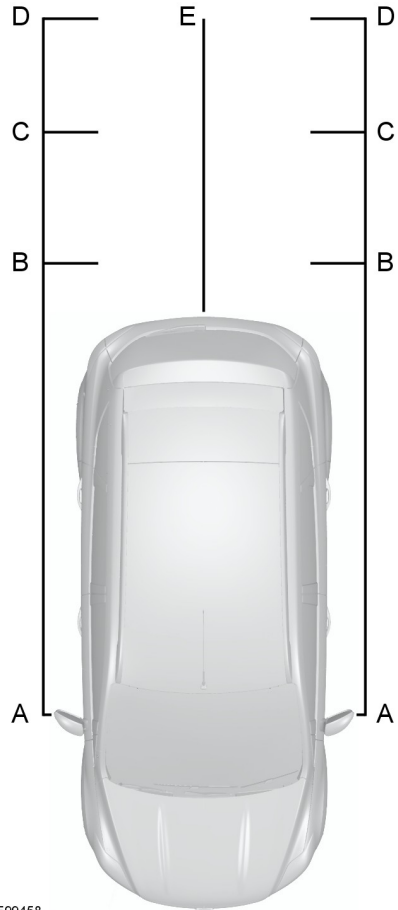

E99458

- A Exterior mirror clearance - 0.1 metre (4 inches)
- B Red - 0.3 metre (12 inches)
- C Amber - 1 metre (39 inches)

Rear view camera

- D Amber - 2 metres (79 inches)
- E Shows the centre line of the projected vehicle path

Note: *When reversing with a trailer, the lines on the screen show the vehicle direction and not the trailer.*

Deactivating the rear view camera

Note: *Disengage reverse gear. The display will stay on for a short period before switching off.*

The system will automatically switch off once the vehicle speed has reached approximately 15 km/h (9 mph).

Vehicles with parking aid

The display will additionally show a coloured distance bar. This guide indicates the distance from the rear bumper to the detected obstacle.

These are colour coded as follows:

- Green - 0.8 to 1.5 metres (31 to 59 inches).
- Amber - 0.3 to 0.8 metre (12 to 31 inches).
- Red - 0.3 metre (12 inches) or less.

Cruise Control

PRINCIPLE OF OPERATION

Cruise control allows you to control your speed using the switches on the steering wheel. You can use cruise control when you exceed 30 km/h (20 mph).

USING CRUISE CONTROL

WARNING



Do not use cruise control in heavy traffic, on twisty roads or when the road surface is slippery.

Switching cruise control on

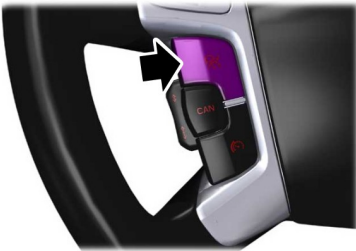

E70612

Setting a speed



E70615

Press the **SET+** switch or the **SET-** switch to store and maintain your current speed. The cruise control indicator illuminates.

Changing the set speed

WARNING



When you are going downhill, your speed may increase above the set speed. The system will not apply the brakes. Change down a gear and press the **RES** switch to assist the system in maintaining the set speed.

Note: *If you accelerate by pressing the accelerator pedal, the set speed will not change. When you release the accelerator pedal, you will return to the speed that you previously set.*

Press the **SET+** switch or the **SET-** switch to accelerate or decelerate.

Cancelling the set speed

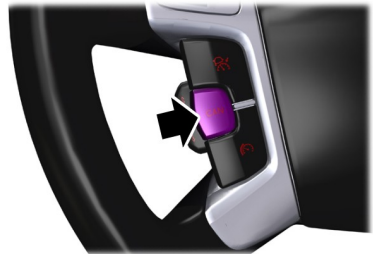

E70614

Press the brake pedal or the **CAN** switch. The system will no longer control your speed. The cruise control indicator will go off but the system will retain the speed that you previously set.

Cruise Control

Resuming the set speed



E70616

Press the **RES** switch. The cruise control indicator illuminates and the system will attempt to resume the speed that you previously set.

Switching cruise control off

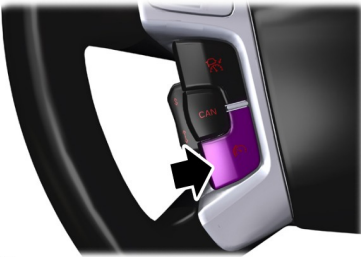

E70613

Press the **OFF** switch. The system will not retain the speed that you previously set. The cruise control indicator will go off.

Adaptive cruise control (ACC)

PRINCIPLE OF OPERATION

WARNINGS



The system is not a collision warning or avoidance system. The separate forward alert function provides a collision warning and mitigation feature. See **Forward alert function** (page 186). You must intervene if the system does not detect a vehicle in front.



When driving you are responsible for maintaining the correct distance and speed, even when adaptive cruise control is used. You must always pay attention to the traffic conditions and intervene when adaptive cruise control is not maintaining a suitable speed or suitable distance.



The system does not relieve you of your responsibility to drive with due care and attention.



The system does not brake for slow or stationary vehicles, pedestrians, objects in the road, oncoming and crossing vehicles.

CAUTIONS



Only use adaptive cruise control when conditions are favourable, for example on motorways and main roads with steady free flowing traffic.



Do not use in poor visibility, specifically fog, heavy rain, spray or snow.



Do not use on icy or slippery roads.



Do not use the system when entering or leaving a motorway.



The radar sensor has a limited field of vision. In some situations it may detect a vehicle other than the one expected or not detect any vehicle at all.

Note: When adaptive cruise control is activated, you may hear some unusual sounds during automatic braking. This is normal and caused by the automatic braking system.

Note: Keep the front of the vehicle free from dirt, metal badges or objects, including vehicle front protectors and additional lights which may prevent the sensor from operating.

The system is designed to help you maintain a gap from the vehicle ahead or a set road speed if there is no slower vehicle ahead. The system is intended to provide enhanced operation of the vehicle when following other vehicles which are in the same lane and travelling in the same direction.

The system is based on the use of a radar sensor which projects a beam directly forward of the vehicle. This beam will detect any vehicle ahead within the system's range.

The radar sensor is mounted behind the front grille.

Adaptive cruise control (ACC)

Detection beam issues

A

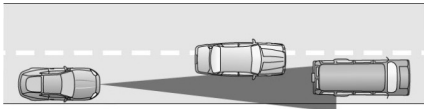

B

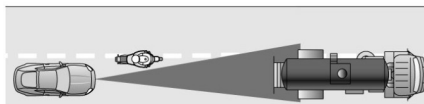

C

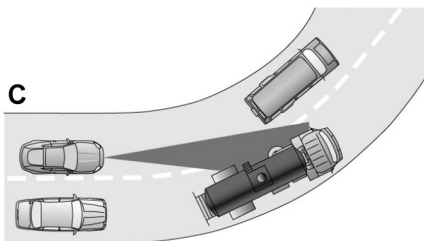

E71621

Detection issues can occur:

- With vehicles that edge into your lane that can only be detected once they have moved fully into your lane (**A**). Motorcycles may be detected late, or not at all. (**B**)
- With vehicles in front when going into and coming out of a bend (**C**). The detection beam will not follow sharp curves in the road.

In these cases the system may brake late or unexpectedly. You should stay alert and intervene if necessary.

Automatic braking with ACC

WARNINGS



You must take immediate action once alerted, as the adaptive cruise control braking will not be sufficient to keep a safe distance to the vehicle in front.



In some cases there may be no warning or the warning may be delayed. You should always apply the brakes when necessary.



When following a vehicle in front of you, adaptive cruise control will not automatically decelerate to a stop.

The system will automatically brake for you, if required to maintain the set gap between your vehicle and the one detected in front. This braking capacity is limited to approximately 30% of the total manual braking capacity to ensure smooth and comfortable cruising. If the car needs to brake more heavily than this, and you do not intervene by braking manually, an alarm will sound and a warning symbol will be displayed in the cluster.

USING ADAPTIVE CRUISE CONTROL

The system is operated by adjustment controls mounted on the steering wheel.

Adaptive cruise control (ACC)

Vehicles without speed limiter

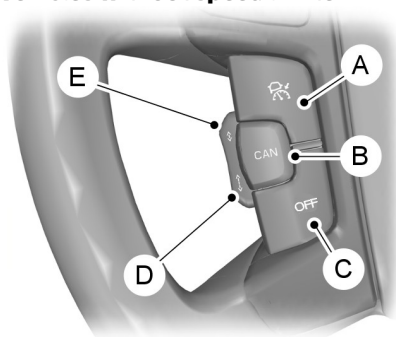

E124908

- A ACC on
- B ACC cancel
- C ACC off
- D ACC gap increase
- E ACC gap decrease

Vehicles with speed limiter

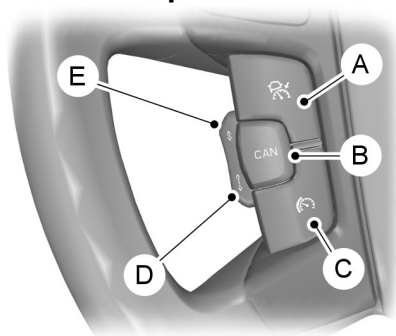

E124909

- A ACC on/off
- B ACC cancel
- C Speed limiter on/off

- D ACC gap increase
- E ACC gap decrease

Switching the system on

Press switch **A**. The system is set to standby mode.

Setting a speed

Note: The system must be in standby mode.

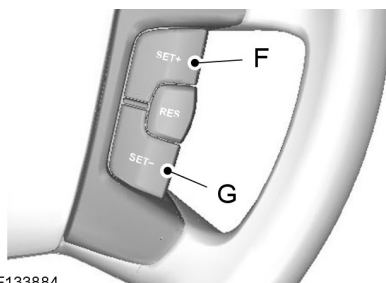

E133884

- F Set speed increase
- G Set speed decrease

Press switch **F** or switch **G** to select your desired cruise speed. The speed is displayed in the information display and stored as the set speed.

Changing the set speed

Note: Vehicle speed may be increased and decreased at intervals of 5 km/h or 5 mph.

Note: If the system does not react to these changes the reason may be that the gap interval to the vehicle in front prevents an increase in speed.

Adaptive cruise control (ACC)

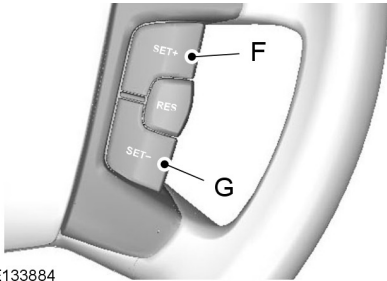

E133884

Press switch **F** to increase or switch **G** to decrease the set speed until the desired set speed is shown in the information display. The vehicle speed will gradually change to the selected speed.

Note: Smaller increases of 1 km/h or 1 mph may be set by pressing switch **H**.

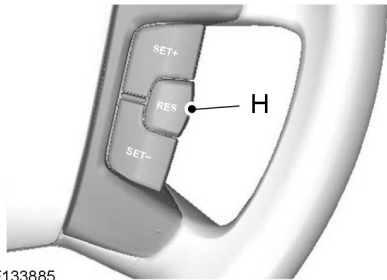

E133885

H ACC resume

Setting the vehicle gap

CAUTION



Use the appropriate gap setting in accordance with local traffic regulations.

Note: The gap setting is time dependant and therefore the distance will automatically adjust with your speed. For example on a gap setting of four bars, the time gap is 1.8 seconds. This will mean that at a speed of 100 km/h (62 mph), the distance to the vehicle in front will be maintained at 50 metres (164 feet).

Note: If the accelerator is depressed for a short period, for example when overtaking, the system is temporarily deactivated and then reactivated when the accelerator pedal is released. A message is displayed in the information display.

Note: The gap setting will remain unchanged during ignition cycles.

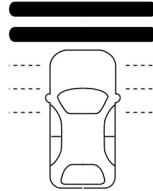

E82311

The distance between you and the vehicle detected in front is maintained by a variable setting. There are five steps which are represented by horizontal bars displayed in the information display. One bar denotes the smallest gap and five bars indicate the largest gap. These bars are shown empty when in standby mode and filled when in active mode.

If no vehicle is detected in front, then only your vehicle is displayed in the information display below the bars. The system will maintain the set speed when conditions permit. The set gap is maintained and displayed.

If a vehicle is detected by the sensor, the display will show another vehicle above the horizontal bars:

Adaptive cruise control (ACC)

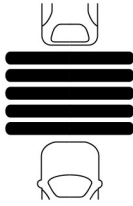

E82312

This is a follow mode, and the system will accelerate or decelerate as necessary to maintain the set gap.

Press switch **E** to decrease the gap or switch **D** to increase the gap. The gap selected will be represented by the number of bars in the display.

Note: The recommended gap setting is four to five bars.

Temporarily deactivating the system

Note: The system is cancelled when the gear lever is moved to a neutral position or if the accelerator pedal or clutch is depressed for a long period of time

Press either the brake or switch **B** to cancel the system. The system will return to standby mode allowing you full manual control of the vehicle. The set speed and gear setting are retained in the memory.

To resume adaptive cruise control press switch **H**. The system will resume with the previously set speed and vehicle gap setting if conditions permit.

Switching the system off

Vehicles without speed limiter

Press switch **C** to turn the system off.

Note: When deactivating the system by pressing switch **C**, the stored speed is not retained.

Vehicles with speed limiter

Press switch **A** to turn the system off.

Note: When deactivating the system by pressing switch **A**, the stored speed is not retained.

Automatic deactivation

Note: If the engine speed drops too low, a message is displayed in the information display instructing you to change down a gear (manual transmission only). If you do not follow this recommendation then the system will go into automatic deactivation mode.

Note: The system will not operate if the electronic stability programme (ESP) has been manually switched off.

The system is dependent on various other safety systems, for example ABS and ESP. If any of these systems are malfunctioning or reacting to an emergency, the system is automatically deactivated.

In the event of automatic deactivation a signal will sound and the message is displayed in the information display. See **Information Messages** (page 101). You must then intervene and adapt your driving and speed to vehicles in front.

An automatic deactivation can be due to the:

- vehicle speed falling below 30 km/h (20 mph)
- wheels losing traction
- brake temperature is high, for example when driving on mountainous or hilly roads
- engine speed is too low
- radar sensor is covered
- parking brake or electric parking brake (EPB) is applied.

Adaptive cruise control (ACC)

FORWARD ALERT FUNCTION

WARNINGS



Never wait for a collision warning. When driving you are responsible for maintaining the correct distance and speed, even when the system is used.



The system will only react to vehicles in front travelling in the same direction and will not react to slow or stationary vehicles.



Never drive in a manner to provoke the system. The system is designed to assist in emergencies only.

CAUTIONS



Warnings may be triggered late, be absent or triggered unnecessarily due to detection beam issues. See **Principle of Operation** (page 181).



The system uses the same radar sensors as adaptive cruise control and therefore has the same limitations. See **Principle of Operation** (page 181).

Note: *The brake support system only reduces the collision speed if you brake immediately once alerted.*

Note: *If the brake pedal is depressed sufficiently quickly then braking is implemented with full brake function, even if the force on the pedal is light.*

Note: *Brake support prepares the brake system for rapid braking and the brakes are applied gently, which may be noticed as a slight jerk.*

Note: *The collision alerts will only occur if the system is switched on, however the brake support is always on and cannot be turned off.*

Note: *The system may be used with or without the Adaptive cruise control system being activated.*

The system assists you by warning of the risk of a collision with a vehicle in front.

The system alerts you by warning chimes and a visual warning in the information display. See **Information Messages** (page 101).

Brake support is activated to enable full braking effectiveness, and reduce the severity of a collision with the vehicle in front.

Switching the system on and off

Note: *When the system is switched off, a warning indicator will remain illuminated in the information display. See **Warning Lamps and Indicators** (page 84).*

Note: *The system status and settings will remain unchanged during ignition cycles.*

The system can be switched on and off using the information display. See **General Information** (page 88).

Adjusting the warning sensitivity

You may adjust the system warning sensitivity using the buttons on the steering wheel. See **General Information** (page 88). This controls how early the visual and audible warning is activated.

Speed Limiter

PRINCIPLE OF OPERATION

WARNING



When you are going downhill, your speed may increase above the set speed. The system will not apply the brakes but a warning will be given.

The system allows you to set a speed, to which the vehicle then becomes limited. The set speed will become the effective maximum speed of the vehicle, but with the option to temporarily exceed this limit if required.

USING THE SPEED LIMITER

The system is operated by adjustment controls mounted on the steering wheel.

Press button **A** to switch the system on and off. The information display will prompt for a speed to be set.

Note: The set speed limit can be intentionally exceeded for a short period if required, for example when overtaking.

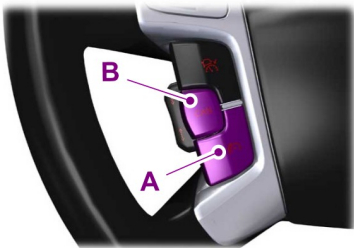

E124874

Setting the speed limit

Use the cruise control switches to alter the maximum speed setting.



E70615

Press the **SET+** switch or the **SET-** switch to select your desired speed limit. The speed is indicated in the information display and stored as the set speed.

Press button **B** to cancel the limiter and place it in standby mode. The information display will confirm deactivation by showing the set speed crossed out.



E70616

Press the **RES** button to resume the limiter. The information display will confirm the system is active by showing the set speed again.

Intentionally exceeding the speed limit

Depress the accelerator hard close to the full pedal travel and the limit will temporarily deactivate. The system will reactivate once the vehicle speed drops below the set speed.

Speed Limiter

System warnings

If the set limit is accidentally exceeded the information display will show the set speed flashing together with an audible warning chime.

If the set limit is intentionally exceeded the information display will show the set speed crossed out.

Driver Alert

PRINCIPLE OF OPERATION

WARNINGS



The system does not relieve you of your responsibility to drive with due care and attention.



At all times you are responsible for controlling the vehicle, supervising the system and intervening if required.



If the sensor becomes blocked the system may not function.



Take regular rest breaks as required and do not wait for the system to warn you if you feel tired.



Take rest breaks only where it is safe to do so.



Certain driving styles and behaviour may result in the system issuing a warning even if you are not feeling tired.

CAUTIONS



In cold and severe weather conditions the system may not function. Rain, snow, spray and large contrasts in lighting can all influence the sensor.



The system will not operate if the sensor cannot track the road lane markings.



The system may not operate in areas during roadworks construction.



The system may not operate on roads with sharp bends or narrow lanes.



Do not carry out windscreen repairs in the immediate area surrounding the sensor.



If your vehicle is fitted with a suspension kit not approved by us, the system may not function correctly.

Note: Keep the windscreen free from obstructions such as bird droppings, insects and snow or ice.

Note: The system is intended as a driver aid when driving on fast main roads and motorways.

Note: The system calculates an alertness level at vehicle speeds above approximately 65 km/h (40 mph).

The system automatically monitors your driving behaviour using various inputs including the front camera sensor.

If the system detects that you are becoming drowsy or there is a deterioration in your driving, the system will alert you.

USING DRIVER ALERT

Switching the system on and off

Note: The system status will remain unchanged during ignition cycles.

Activate the system using the information display. See **Information Displays** (page 88).

Once activated the system will calculate your alertness level based upon your driving behaviour in relation to the lane markings, and other factors.

System warnings

Note: The system will not issue warnings below approximately 65 km/h (40 mph).

The warning system is in two stages. At first the system issues a temporary warning that a rest should be taken. This message will only appear for a short time. If a rest is not then taken a further warning may be issued which will remain in the information display until cancelled. See **Information Messages** (page 101).

Press **OK** on the steering wheel control to remove the warning.

Driver Alert

System display

When active the system will run automatically in the background and only issue warnings if required. You can view the status at any time using the information display. See **General Information** (page 88).

The alertness level is shown by six steps as a coloured bar.

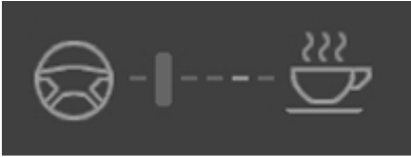

E131358

Alertness level is fine, no rest required.

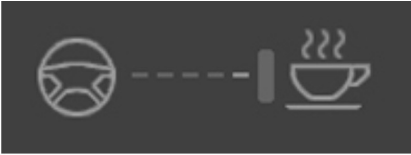

E131359

Alertness level is critical, indicating that a rest should be taken as soon as safely possible.

The status bar will travel from left to right as the calculated alertness level decreases. As the rest icon is approached the colour turns from green to yellow and then finally red when a rest break must be taken.

- Green - No rest required.
- Yellow - First (temporary) warning.
- Red - Second warning.

Note: *The alertness level will be shown in grey if the camera sensor cannot track the road lane markings or if the vehicle speed drops below approximately 65 km/h (40 mph).*

Resetting the system

You can reset the system by either:

- Switching the ignition off and on.
- Stopping the vehicle and then opening and closing the driver's door.

Lane Departure Warning

PRINCIPLE OF OPERATION

WARNINGS



The system does not relieve you of your responsibility to drive with due care and attention.



At all times you are responsible for controlling the vehicle, supervising the system and intervening if required.



If the sensor becomes blocked the system may not function.



Lane markings may not always be properly tracked by the sensor. Other structures or objects may sometimes be incorrectly detected as a lane marking, resulting in a false or missed warning.

CAUTIONS



In cold and severe weather conditions the system may not function. Rain, snow, spray and large contrasts in lighting can all influence the sensor.



The system will not operate if the sensor cannot track the road lane markings.



The system may not operate in areas during roadworks construction.



The system may not operate on roads with sharp bends or narrow lanes.



Do not carry out windscreen repairs in the immediate area surrounding the sensor.



If your vehicle is fitted with a suspension kit not approved by us, the system may not function correctly.

Note: Keep the windscreen free from obstructions such as bird droppings, insects and snow or ice.

Note: The system is intended as a driver aid when driving on fast main roads and motorways.

Note: The system may not operate during hard braking or acceleration and, when you are intentionally steering the vehicle.

Note: The system will operate with a minimum of one tracked lane marking.

Note: The system will only operate above vehicle speeds of approximately 65 km/h (40 mph).

A sensor is mounted behind the interior rear view mirror. It continuously monitors conditions to alert you of unintentional lane drifting at high speeds.

The system will automatically detect and track the lane markings on the road. If it detects that the vehicle is unintentionally drifting towards the lane boundaries then a visual warning will be displayed in the information display. There is also a warning given in the form of a vibration felt through the steering wheel.

USING LANE DEPARTURE WARNING

Switching the system on and off

Note: When the system is switched off, a warning indicator will remain illuminated in the information display. See **Warning Lamps and Indicators** (page 84).

Note: The system status and settings will remain unchanged during ignition cycles.

Lane Departure Warning



E131360

- A System on
- B System off

Activate the system using the switches on the indicator stalk.

Setting the steering wheel vibration level

The system has three intensity levels which can be set using the information display. See **General Information** (page 88).

Setting the system sensitivity

You can adjust how quickly the system warns you of a dangerous situation. The system has two sensitivity levels which can be set using the information display. See **General Information** (page 88).

System warnings



E131363

A column of lane markings is displayed either side of the vehicle graphic.

The lane markings are colour coded as follows:

- Green - The system is ready to warn you of any unintentional lane departure.
- Red - The vehicle is approaching or is too close to the detected lane boundary. Take immediate safe action to reposition the vehicle.
- Grey - The relevant lane boundary will be suppressed.

Instances where a lane boundary may be suppressed:







- Lane markings on the road may not be detected by the sensor.
- The direction indicator for that side of the vehicle is on.
- During hard acceleration and braking, or if direct steering is applied.
- Vehicle speed is outside the operating limits
- If there is an ABS or Stability Control (ESP) intervention.
- Narrow lane width.

If the lane markings turn red or a vibration is felt through the steering wheel you must take immediate and safe action to align the vehicle and correct any unintended lane drift.



Load Carrying

GENERAL INFORMATION

WARNINGS

-  Use load securing straps to an approved standard, e.g. DIN.
-  Make sure that you secure all loose items properly.
-  Place luggage and other loads as low and as far forward as possible within the luggage or loadspace.
-  Do not drive with the tailgate or rear door open. Exhaust fumes may enter the vehicle.
-  Do not exceed the maximum front and rear axle loads for your vehicle. See **Vehicle identification** (page 265).
-  Heavy loads, when placed in the passenger compartment, should be on folded rear seats as shown. See **Rear Seats** (page 128).
-  Fit a dog guard or load net if placing heavy loads behind the front seats in the passenger compartment.

CAUTIONS

-  Do not allow items to contact the rear windows.
-  Do not use any abrasive materials to clean the interior of the rear windows.
-  Do not install stickers or labels to the interior of the rear windows.



E135667

Load Carrying

LUGGAGE ANCHOR POINTS

Galaxy

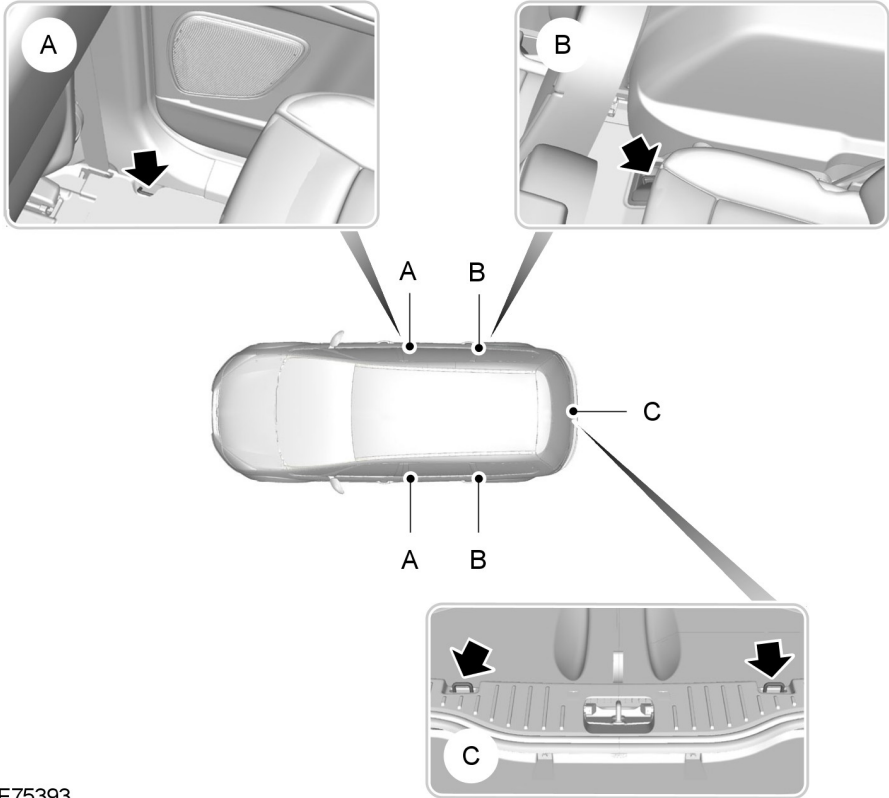

E75393

Load Carrying

S-MAX

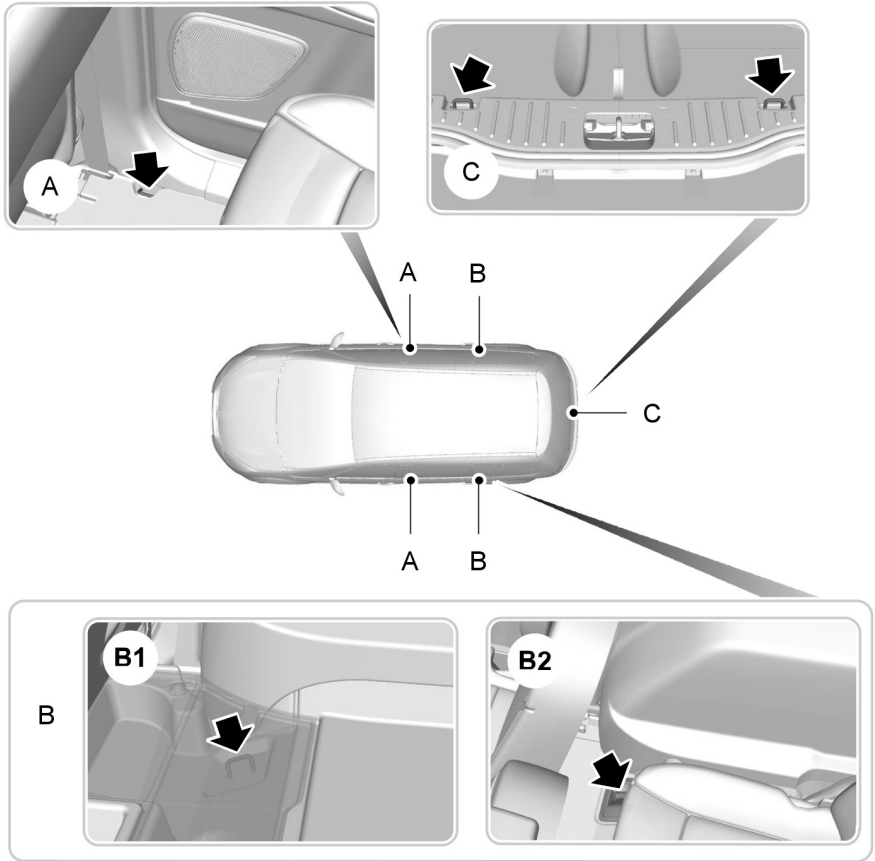

E75394

- B1 Vehicles without third row seats. Raise the carpet to gain access to the anchor points.
- B2 Vehicles with third row seats

Load Carrying

SLIDING LOADSPACE FLOOR

WARNING

 Do not slide the loadspace floor rearwards when the vehicle is standing on an incline of 15 degrees or more and facing uphill.

CAUTION

 The maximum permissible weight on the sliding loadspace floor is 200 kilogrammes (441 pounds).

The maximum permissible weight on the end of the sliding loadspace floor when the floor is in the fully extended position (slid outside the luggage compartment) is 120 kilogrammes (265 pounds).



E74810

Press the unlocking handle and pull the loadspace floor rearwards. It will stop and engage at a midway position.

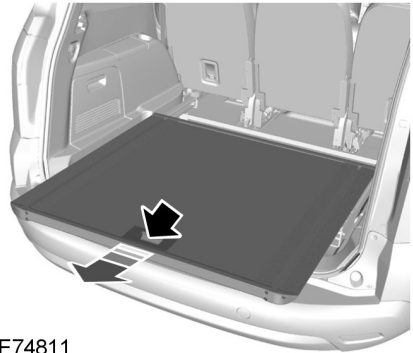

E74811

To slide it out fully, press the unlocking handle again and pull it out until it engages in the end position.

To slide it forwards, press the unlocking handle and push it forwards.

Note: *You do not have to exert as much pressure on the unlocking handle if you push the loadspace floor forwards slightly when operating it.*

Storage compartment

A storage compartment is located in the floor at the rear of the luggage compartment.

To gain access to the storage compartment, lift up the sliding loadspace floor as follows:

Load Carrying

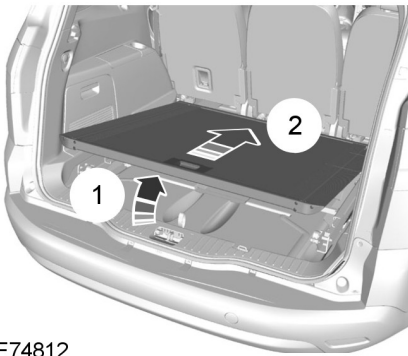

E74812

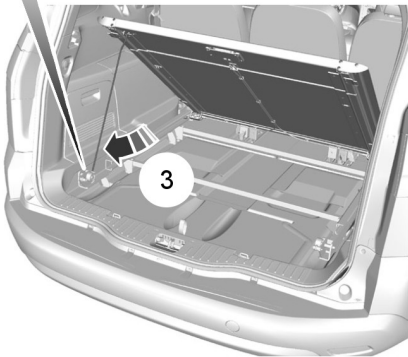
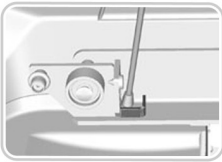

E74813

1. Press the unlocking handle and pull the loadspace floor rearwards a short way.
2. Lift up the rear of the floor (1).
3. Push the floor forwards until it engages at the front (2).

4. Release the support leg from the clip on the underside of the floor.
5. Insert the end into the square retainer in the left-hand rail (3).
6. Lift the storage compartment cover using the loop.

To return the loadspace floor to the normal position:

1. Hold the floor with one hand and release the support leg with the other hand.
2. Insert the support leg back into the clip.
3. Lower the floor.
4. Press the unlocking handle and pull the loadspace floor rearwards until it drops into position on the rails.

REAR UNDER FLOOR STORAGE

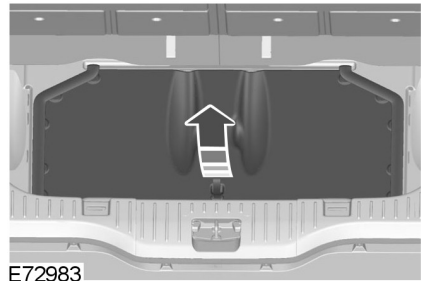

E72983

Vehicles with a sliding loadspace floor

Raise the loadspace floor to gain access to the storage compartment. See **Sliding Loadspace Floor** (page 196).

Load Carrying

S-MAX

Vehicles without third row seats

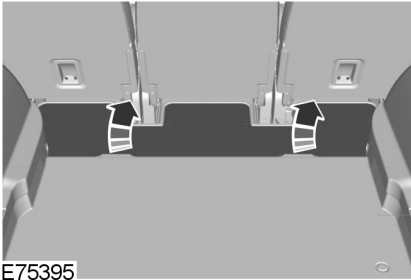

CARGO NETS

Luggage retention net - type 1

WARNING



When the retention net is installed, do not sit in the seats behind it.

CAUTION



Keep a distance of at least one centimetre (½ inch) between the retention net and the seats in front of it.

You can install the net in the following positions:

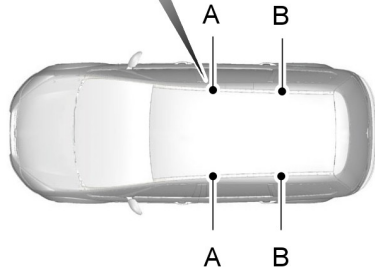

E75891

- A Behind the front seats
- B Behind the second row seats

Load Carrying

Installing the net

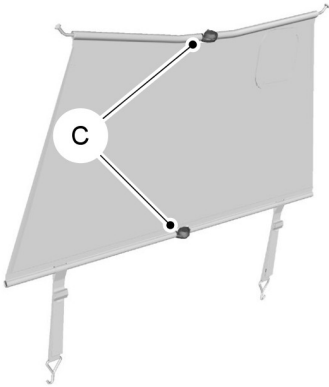
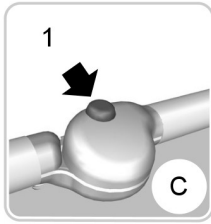

E75893

C Release button

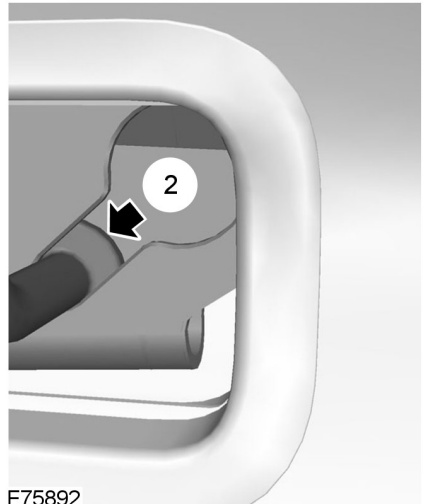

E75892

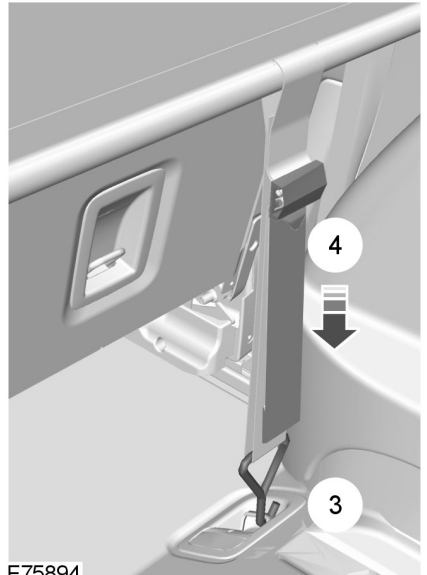

E75894

Load Carrying

1. Fold the seatbacks down. See **Rear Seats** (page 128).
2. If the retention net is folded, press the red release button **C** on the hinges of the upper and lower bar **1** and unfold it.
3. Push the ends of the upper bar towards each other and insert them into the retainers on the roof **A** or **B**. Make sure that the flap for the centre seat belt is situated on the right hand side of the vehicle.
4. Push the bar forwards into the narrow section of the retainers **2**.
5. Attach the net to the luggage anchor points **3**. See **Luggage Anchor Points** (page 194).
6. Tighten the belts **4**.

Remove in the reverse order.

If you need to use the centre seat belt:

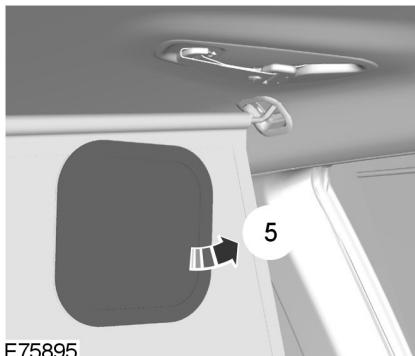

E75895

1. Open the flap **5**.
2. Route the seat belt through the opening.

Luggage retention net - type 2

CAUTIONS

- ! Do not exceed the maximum permissible retention net load of 1 kilogram (2 pounds).
- ! Do not place large objects in the lower net storage compartments.
- ! Make sure that the rods are securely positioned in the trim panels.

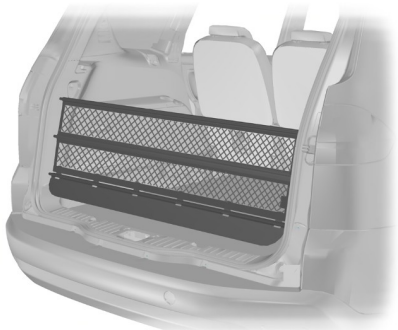

E95920

1. Fold the third row seats flat. See **Rear Seats** (page 128).
2. Insert one end of each rod into the retainers in the luggage compartment trim panel.
3. Push the other end of each rod toward its centre and insert the rod into the retainer in the opposite trim panel.

Note: The upper rod ends can be inserted into either the top or front retainer in the trim panels.

Note: On S-MAX the lower net incorporates three storage compartments. Make sure that the net is positioned so that the storage compartments face towards the rear.

Load Carrying

LUGGAGE COVERS

WARNING



Do not place objects on the luggage cover.

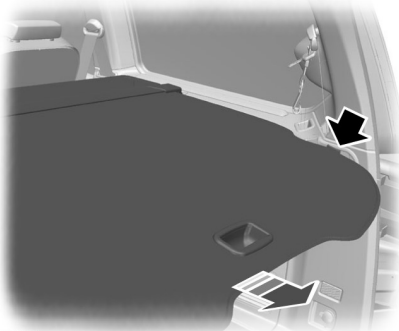

E72969

Pull out the cover and secure it in the retaining points.

Release it from the retaining points and let it roll back into the case. Clip the retaining hook onto the case.

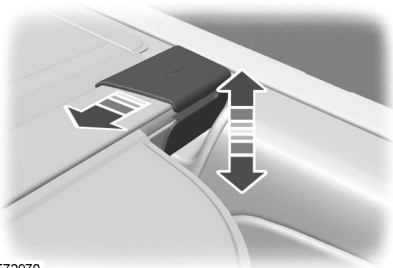

E72970

To remove or install the cover, push either end of the case inwards.

ROOF RACKS AND LOAD CARRIERS

Roof rack

WARNINGS



If you use a roof rack, the fuel consumption of your vehicle will be higher and you may experience different driving characteristics.



Read and follow the manufacturer's instructions when you are fitting a roof rack.

CAUTIONS



Do not exceed the maximum permissible roof load of 75 kilogrammes (165 pounds) (including the roof rack).



Do not exceed 130 km/h (81 mph).

Check the security of the roof rack as follows:

- before starting
- after driving 50 kilometres (30 miles)
- at 1 000 kilometres (600 miles) intervals.

To minimise windnoise when the roof rack is not in use, cross rails should be moved rearwards and placed together. To reduce fuel consumption, cross rails should be removed when not in use.

Installing the crossbars

WARNINGS



Before using the crossbars, check that they are not damaged or deformed and free from foreign matter.

Load Carrying

WARNINGS



Make sure that the gaskets are correctly positioned under each crossbar foot.



Distribute the load evenly over the loading area and keep the centre of gravity as low as possible. Secure the load well to prevent it from slipping. Never place any loads directly onto the roof surface.

CAUTION



Remove the crossbars before entering an automatic car wash.

Note: The gaskets are marked front and rear to aid installation.

Note: The side mounting tracks are designed such that crossbars (for bicycle carriers, ski carriers etc.) from the Ford accessories range can be fitted.

Note: Before installing the crossbars, clean the side mounting tracks with water and a sponge.

Note: Position the crossbars as shown.

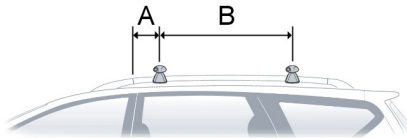

E98206

- A 150 mm (5.9 inches)
B 700 mm (27.6 inches)

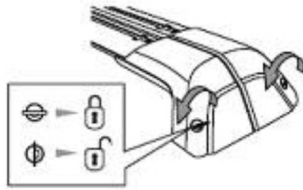

E131371

1. Unlock the covers.

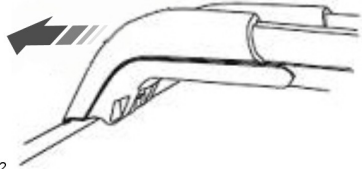

E131372

2. Pull the cover towards you.

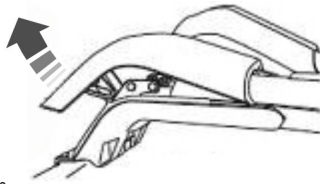

E131373

Note: Make sure that the cover is fully opened.

3. Lift the cover

Load Carrying

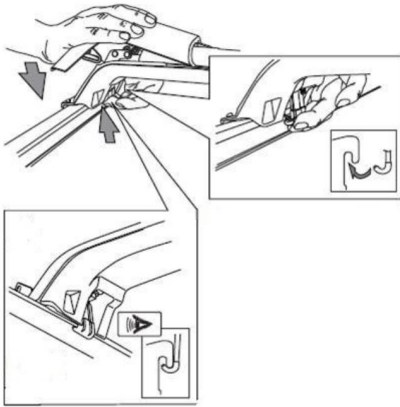

E131374

WARNING



Make sure that the clamping hook is correctly positioned.

Note: A force of approximately 100 newtons (23 lbs) is required to close the cover.

4. Attach the clamping hook in the position shown and close the cover.

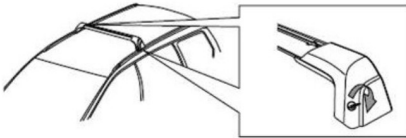

E131375

WARNING



Make sure that the crossbars are secure.

5. Lock the covers and remove the key.

LOAD RETAINING FIXTURES



E75002

WARNINGS



Do not raise the seatback when a load retaining fixture is installed.



Do not exceed the maximum permissible load of 60 kilogrammes (132 pounds) on two load retaining fixtures and 30 kilogrammes (66 pounds) on one.

Check the security of the load retaining fixtures and tighten its fittings as follows:

- before starting
- after driving 50 kilometres (30 miles)
- at 1 000 kilometres (600 miles) intervals.

Load Carrying

Installing the load retaining fixtures

Seatback

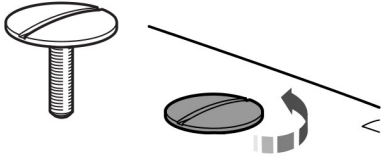

E74997

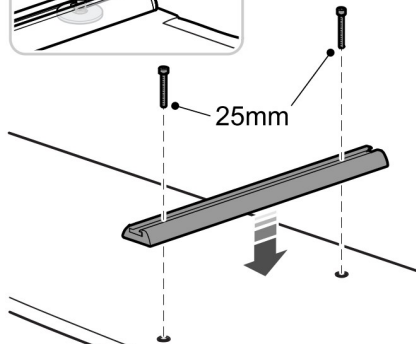
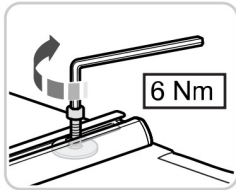

E74998

Luggage compartment floor (vehicles with five seats)

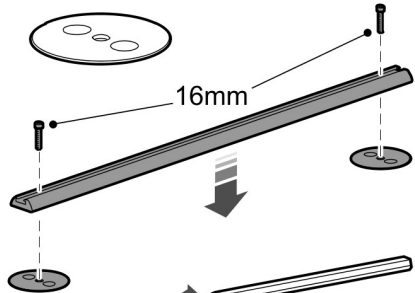

E74999

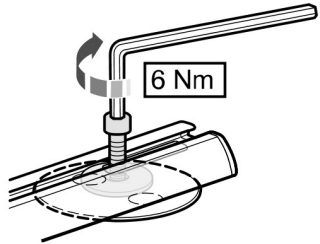

Load Carrying

Sliding loadspace floor

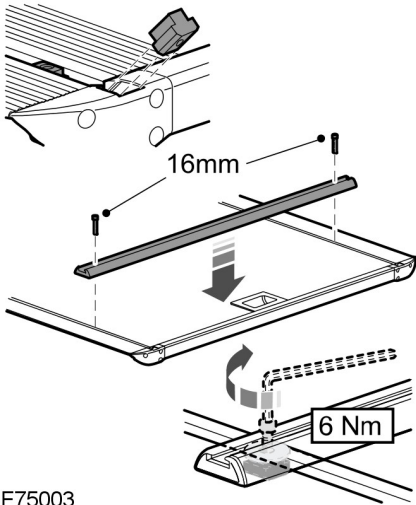

E75003

Installing the luggage anchor points

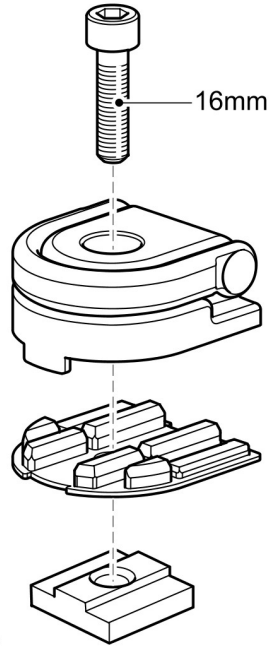

E75000

Load Carrying

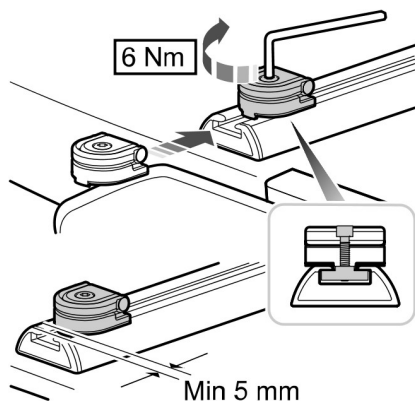



E75001

Installing the load bracket

WARNINGS

 Install the load bracket with the longest section towards the rear of the vehicle. If you install it the wrong way round, it may not hold the box in place in the event of an accident.

 Do not install the load bracket on a second row seatback. It cannot be installed the right way round in this position.

 Do not exceed the maximum permissible load of 20 kilogrammes (44 pounds).

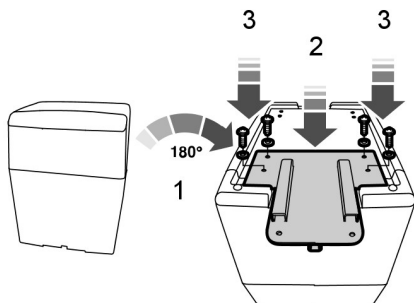

E76378

1. Turn the box over.
2. Position the load bracket.
3. Secure the load bracket with four screws.

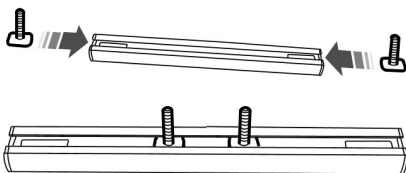

E76379

4. Slide the captured bolts onto the load retaining fixture.

Load Carrying

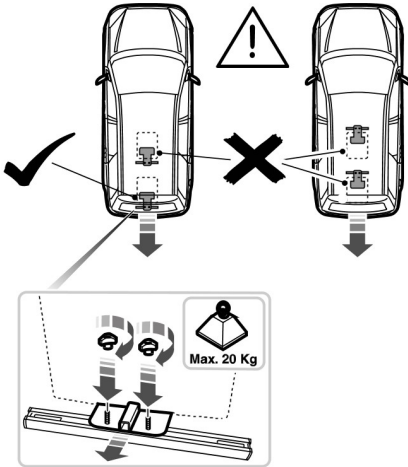

E76380

5. Position the load bracket onto the folded seatback so that the captured bolts go through the two holes in longest section of the bracket.
6. Secure the load bracket with the two wing nuts.
7. Remove in the reverse order.

DOG GUARD

WARNING



When the dog guard is installed, do not sit in the seats behind it.

CAUTION



Keep a distance of at least one centimetre (1/2 inch) between the dog guard and the seats in front of it.

You can install the dog guard in the following positions:

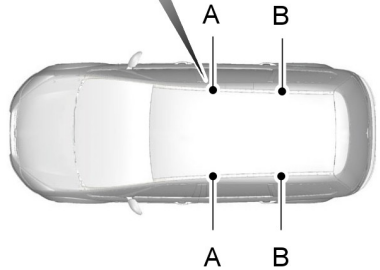

E75891

- A Behind the front seats
- B Behind the second row seats

Installing the dog guard

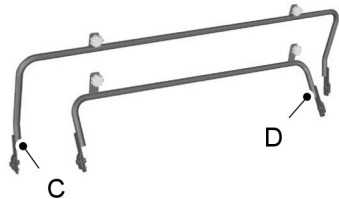

E75896

- C Bar for installing the dog guard behind the front seats
- D Bar for installing the dog guard behind the second row seats

Load Carrying

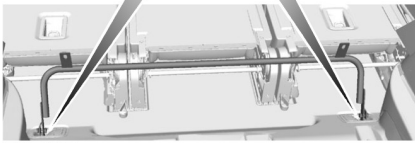
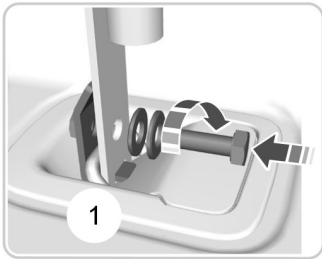

E75897

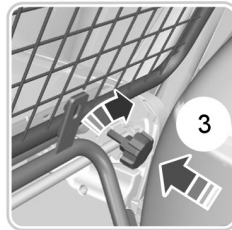
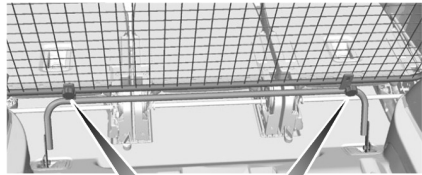

E75898

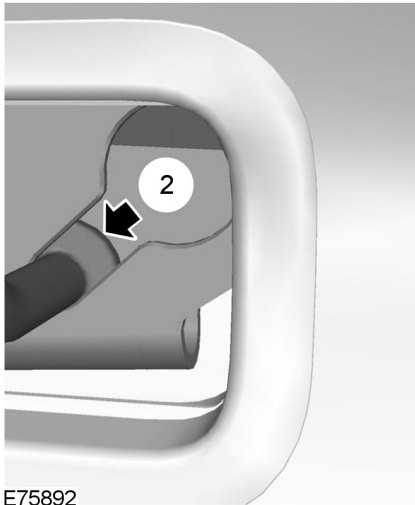

E75892

1. Fold the seatbacks down. See **Rear Seats** (page 128).
2. Attach the bar (**C** or **D**) to the luggage anchor points **1**. See **Luggage Anchor Points** (page 194). Do not tighten the screws.
3. Push the ends of the bar on the grille towards each other and insert them into the retainers on the roof (**A** or **B**). Make sure that the flap for the centre seat belt is situated on the right hand side of the vehicle.
4. Push the bar forwards into the narrow section of the retainers **2**.
5. Attach the grille to the lower bar with the handwheels **3**. Do not tighten the handwheels.
6. Tighten the screws at the luggage anchor points.
7. Tighten the handwheels **3**.

Remove in the reverse order.

If you need to use the centre seat belt:

Load Carrying

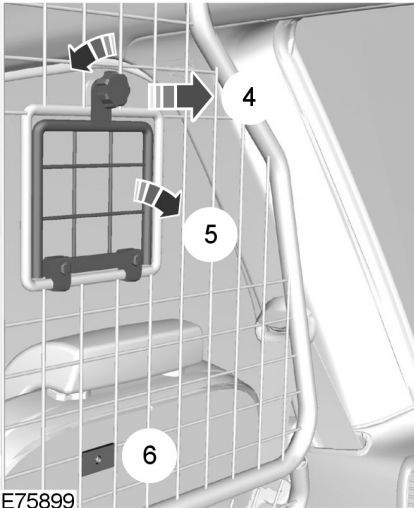

1. Loosen the handwheel and remove it **4**.
2. Fold down the flap **5**.
3. Fix the flap with the handwheel **6**.
4. Route the seat belt through the opening.

Towing

TOWING A TRAILER

WARNINGS



Do not exceed 100 km/h (62 mph).



The rear tyre pressures must be increased by 0.2 bar (3 psi) above specification. See **Technical Specifications** (page 262).



Do not exceed the maximum gross train weight stated on the vehicle identification plate. See **Vehicle identification** (page 265).

CAUTION



Do not exceed the maximum permissible nose weight, i.e. vertical weight on the tow ball, of 90 kilogrammes (198 pounds).

Note: *Not all vehicles are suitable or approved to have tow bars fitted. Check with your dealer first.*

Place loads as low and central to the axle(s) of the trailer as possible. If you are towing with an unladen vehicle, the load in the trailer should be placed toward the nose, within the maximum nose load, as this gives the best stability.

The stability of the vehicle to trailer combination is very much dependant on the quality of the trailer.

In high altitude regions above 1 000 metres (3 281 feet), the stipulated maximum permitted gross train weight must be reduced by 10% for every additional 1 000 metres (3 281 feet).

Steep gradients

WARNING



The overrun brake on a trailer is not controlled by ABS.

Change down a gear before you reach a steep downhill gradient.

TOW BALL

WARNINGS



When not in use, always transport the tow ball arm securely fastened in the luggage compartment.



Take special care when fitting the tow ball arm as the safety of the vehicle and the trailer depends on this.



Do not use any tools for mounting or dismounting the tow ball arm. Do not modify the trailer coupling. Do not disassemble or repair the tow ball arm.

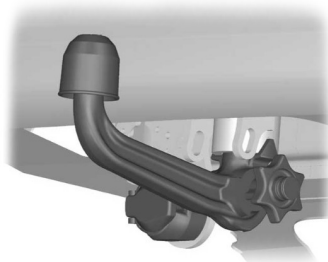

E71328

A 13-pin trailer socket and the tow ball arm seat are provided underneath the rear bumper. Turn the trailer socket down through 90 degrees until it engages in the end position.

Towing

Unlocking the tow ball arm mechanism

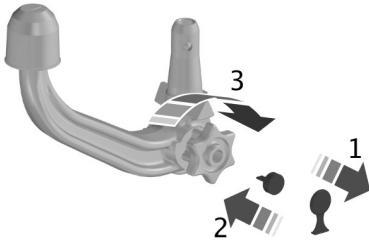

E71329

1. Remove the protecting cap (1). Insert the key and turn it clockwise to unlock (2).
2. Hold the tow ball arm. Pull the handwheel out and turn it clockwise until it clicks (3).
3. The red mark on the handwheel must align with the green mark on the tow ball.
4. Release the handwheel. The tow ball arm is unlocked.

Inserting the tow ball arm

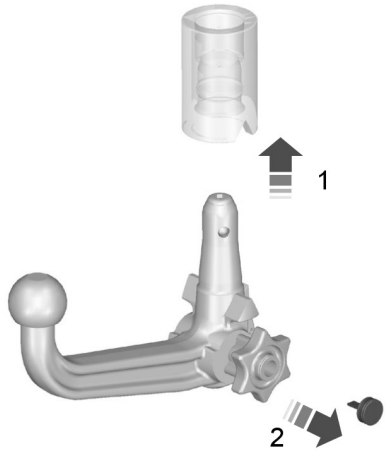

E71330

WARNING



The tow ball arm may only be inserted when completely unlocked.

1. Pull out the plug.
2. Insert the tow ball arm vertically and press it upwards until it engages (1). Do not hold your hand near the handwheel.
3. The green mark on the handwheel must align with the green mark on the tow ball.
4. To lock, turn the key anti-clockwise and remove the key (2).
5. Pull the protecting cap from the key bow and press it onto the lock.

Towing

Driving with a trailer

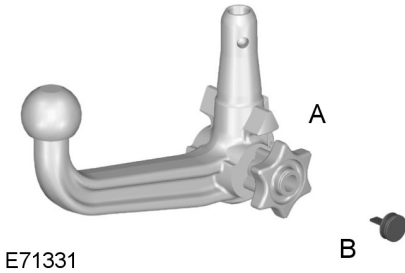

WARNING



If any of the below conditions cannot be met, do not use the tow bar and have it checked by a properly trained technician.

Before starting your journey, make sure that the tow ball arm is properly locked. Check that:

- the green marks are aligned
- the handwheel (**A**) is correctly fitted to the tow ball arm
- you have removed the key (**B**)
- the tow ball arm is securely positioned. It must not move when jerked.

Removing the tow ball arm

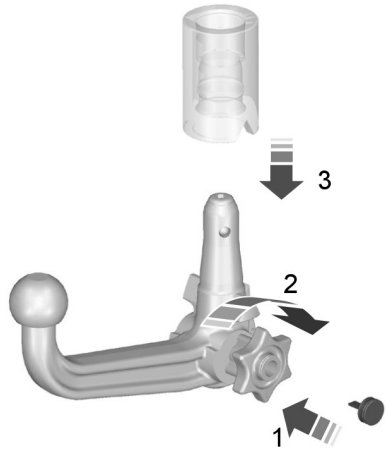

1. Unhitch the trailer.
2. Remove the protecting cap. Press the cap into the key bow. Insert the key and unlock (**1**).
3. Hold the tow ball arm. Pull the handwheel out, turn it clockwise against the stop (**2**) and remove the tow ball arm (**3**).
4. Release the handwheel.

When unlocked in this way, the tow ball arm can be reinserted at any time.

Towing

Driving without a trailer

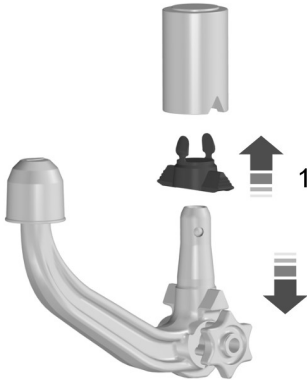

E94771

1. Remove the tow ball arm.
2. Insert the plug into its seat (1).

WARNING



Never unlock the tow ball arm with the trailer attached.

Maintenance

WARNING



Remove the tow ball arm and protect the seat with the plug before steam cleaning your vehicle.

Keep the system clean. Periodically lubricate bearings, sliding surfaces, and locking balls with resin-free grease or oil and the lock with graphite.

In case of loss, replacement keys are available from the manufacturer by stating the number on the lock cylinder.

RETRACTABLE TOW BALL

CAUTION



Only move the tow ball arm with your hand. Never use your foot or auxiliary tools as damage to the mechanism may result.

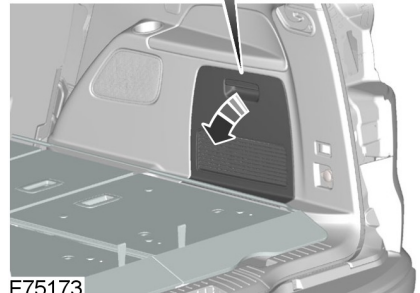
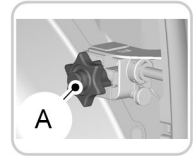

E75173

You can turn the retractable tow ball arm through 90 degrees using the handwheel **A**.

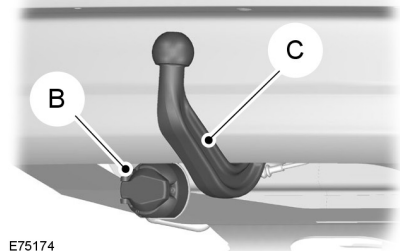

E75174

Towing

A 13-pin trailer socket **B** is provided underneath the rear bumper next to the tow ball arm **C**.

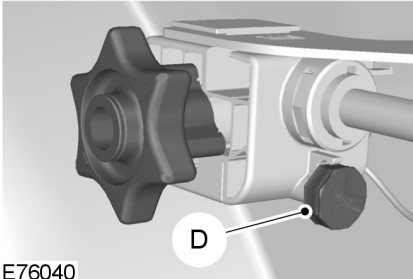

Note: When not in use, insert the key into the storage position **D** to the right of the handwheel.

Swivelling the tow ball in

WARNINGS



Keep your hands away from the handwheel as it rotates during the locking process.



You will hear a warning tone when the tow ball arm is not in one of the locked positions. If you do not hear the tone when moving the tow ball arm, do not use the tow bar and have it checked by a properly trained technician.

CAUTION



Before retracting the ball neck into its stowage position always unhitch the trailer or dismantle load carriers and their attachments. Dismantle attachments for tracking stabilisation. Remove the plug for the trailer power supply and the adapter from the socket. Failure to do so may result in damage to the bumper.

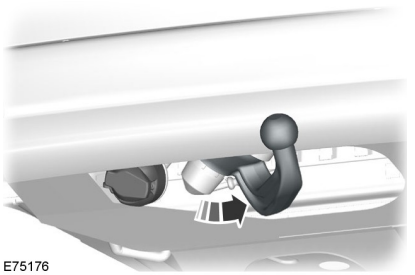
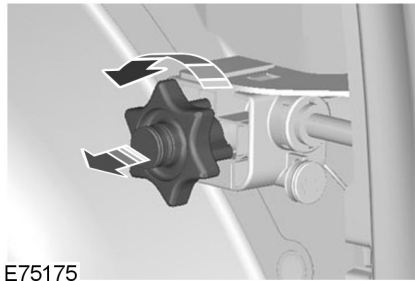

1. Insert the key into the handwheel and turn it clockwise to unlock.
2. Pull the handwheel out and turn it anti-clockwise to the stop. The tow ball arm automatically swivels into a midway position.
3. Release the handwheel. The tow ball arm is not locked. This is indicated by the warning tone and the handwheel projects about five millimetres (0.2 inch) from its housing.

Towing

4. Manually turn the tow ball arm steadily from its midway position to the stop in the stowage position. The tow ball arm automatically locks in the end position. The locking process is clearly audible if the level of background noise is not too high. When the locking process is completed, the warning tone stops and the handwheel will return to its original position.
5. Turn the key anti-clockwise and remove it. Insert the key into the storage position.

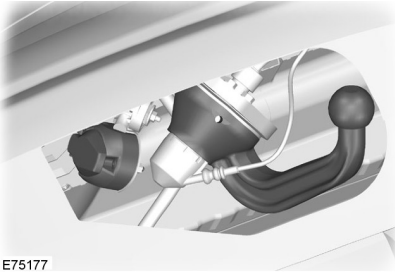

Swivelling the tow ball out

WARNING

 You will hear a warning tone when the tow ball arm is not in one of the locked positions. If you do not hear the tone when moving the tow ball arm, do not use the tow bar and have it checked by a properly trained technician.

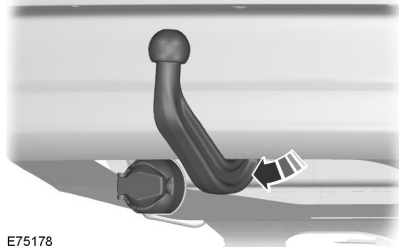
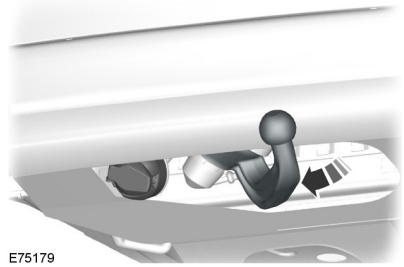

1. Insert the key into the handwheel and turn it clockwise to unlock.
2. Pull the handwheel out and turn it anti-clockwise to the stop. The tow ball arm automatically swivels into the midway position.
3. Release the handwheel. The tow ball arm is not locked. This is indicated by the warning tone and the handwheel projects about five millimetres (0.2 inch) from its housing.

Towing

4. Manually turn the tow ball arm steadily from its midway position to the stop in the operating position. The tow ball arm automatically locks in the end position. The locking process is clearly audible if the level of background noise is not too high. When the locking process is completed, the warning tone stops and the handwheel will return to its original position.
5. Turn the key anti-clockwise and remove it. Insert the key into the storage position.

Driving with a trailer

WARNING



If any of the conditions below cannot be met, do not use the tow bar and have it checked by a properly trained technician.

Before starting your journey, make sure that the tow ball arm is properly locked. Check that:

- there is no warning tone when the locking procedure has been completed
- the handwheel is in its housing and that there is no gap
- you have locked the handwheel (anti-clockwise) and removed the key
- the tow ball arm is locked. It must not move when jerked.

Maintenance

CAUTIONS



The towing hitch and control unit are maintenance-free. Do not grease or oil them.



Only the manufacturer should carry out repairs or dismantle the towing hitch.

CAUTIONS



When cleaning the vehicle with a steam jet do not direct the high pressure jet directly onto the swivel joint of the tow ball arm.

Driving Hints

RUNNING-IN

Tyres

WARNING



New tyres need to be run-in for approximately 500 kilometres (300 miles). During this time, you may experience different driving characteristics.

Brakes and clutch

WARNING



Avoid heavy use of the brakes and clutch if possible for the first 150 kilometres (100 miles) in town and for the first 1500 kilometres (1000 miles) on motorways.

Engine

CAUTION



Avoid driving too fast during the first 1500 kilometres (1000 miles). Vary your speed frequently and change up through the gears early. Do not labour the engine.

COLD WEATHER PRECAUTIONS

The functional operation of some components and systems can be affected at temperatures below -30°C (-22°F).

DRIVING THROUGH WATER

Driving through water

CAUTIONS



Drive through water in an emergency only, and not as part of normal driving.



Engine damage can occur if water enters the air filter.

In an emergency, the vehicle can be driven through water to a maximum depth of 200 millimetres (8 inches) and at a maximum speed of 10 km/h (6 mph). Extra caution should be exercised when driving through flowing water.

When driving in water, maintain a low speed and do not stop the vehicle. After driving through water, and as soon as it is safe to do so:

- Depress the brake pedal lightly and check that full brake function is achieved.
- Check that the horn works.
- Check that the vehicle's lights are fully operational.
- Check the power assistance of the steering system.

FLOOR MATS



WARNINGS



Always use floor mats that are designed to fit the foot well of your vehicle. Only use floor mats that leave the pedal area unobstructed. Only use floor mats that are firmly secured to retention posts so that they cannot slip out of position and interfere with the pedals or impair safe operation of your vehicle in other ways.

Driving Hints

WARNINGS



Pedals that cannot move freely can cause loss of vehicle control and increase the risk of serious personal injury.



Always make sure that the floor mats are properly attached to the retention posts in the carpet that are supplied with your vehicle. Floor mats must be properly secured to both retention posts to ensure mats do not shift out of position.



Never place floor mats or any other covering in the vehicle foot well that cannot be properly secured to prevent them from moving and interfering with the pedals or the ability to control the vehicle.



Never place floor mats or any other covering on top of already installed floor mats. Floor mats should always rest on top of vehicle carpeting surface and not another floor mat or other covering. Additional floor mats or any other covering will reduce the pedal clearance and potentially interfere with pedal operation.



Check attachment of floor mats on a regular basis. Always properly reinstall and secure floor mats that have been removed for cleaning or replacement.



Always make sure that objects cannot fall into the driver foot well while the vehicle is moving. Objects that are loose can become trapped under the pedals causing a loss of vehicle control.



Failure to properly follow floor mat installation or attachment instructions can potentially cause interference with pedal operation causing loss of control of vehicle.



To install floor mats, position the floor mat so that the eyelet is over the retention post and press down to lock in.

WARNINGS



To remove the floor mat, reverse the installation procedure.

Roadside Emergencies

FIRST AID KIT

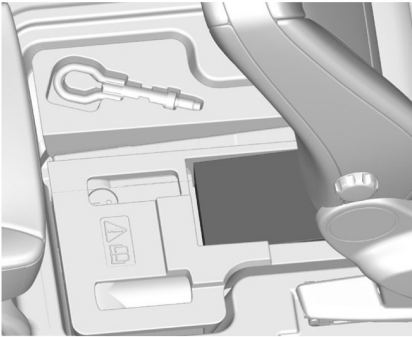

E73238

Space is provided in the under floor storage compartment to store a first aid kit. See **Storage compartments** (page 139).

WARNING TRIANGLE

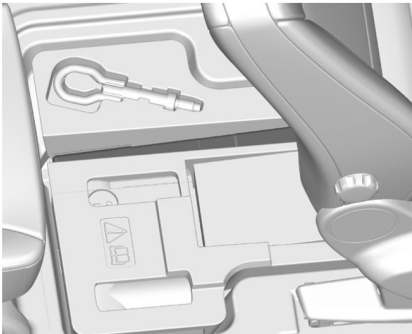

E73239

Space is provided in the under floor storage compartment to store a warning triangle. See **Storage compartments** (page 139).

Fuses

FUSE BOX LOCATIONS

Engine compartment fuse box

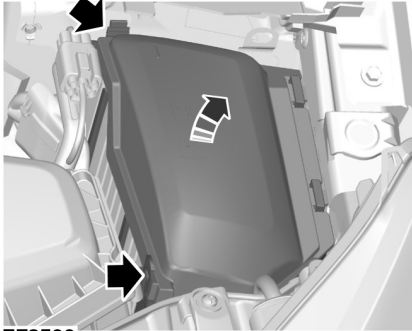

E72588

Central fuse box

All vehicles

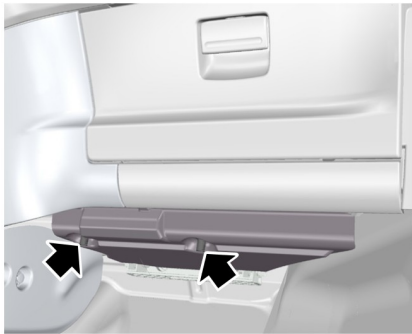

E72589

1. Pinch the retaining clips to release the cover.

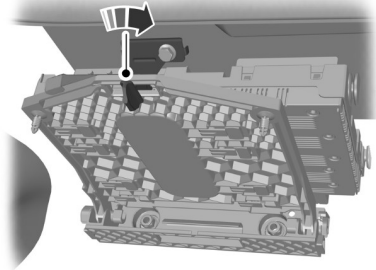

E72590

2. Remove the cover.
3. Turn the knob through 90 degrees and release the fuse box from the retaining bracket.
4. Lower the fuse box cover and pull it towards you.
5. Install in the reverse order.

Rear fuse box

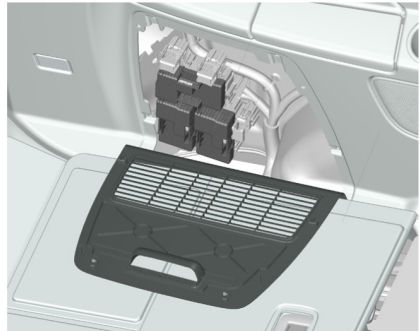

E72591

Release the catches and remove the cover.

Fuses

CHANGING A FUSE

WARNINGS



Do not modify the electrical system of your vehicle in any way. Have repairs to the electrical system and the replacement of relays and high current fuses carried out by a properly trained technician.



Switch the ignition and all electrical equipment off before touching or attempting to change a fuse.

CAUTION



Fit a replacement fuse with the same rating as the one you have removed.

Note: *You can identify a blown fuse by a break in the filament.*

Note: *All fuses, except high current fuses, are a push fit.*

Note: *A fuse puller is located in the engine compartment fuse box.*

Fuses

FUSE SPECIFICATION CHART

Engine compartment fuse box

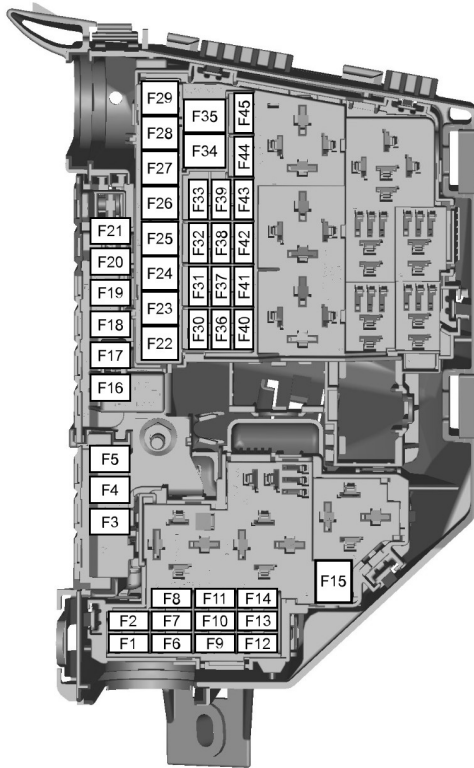

E75525

Fuse	Ampere rating	Circuits protected
F1	10	Transmission control module (AWF21)
F1	15	Transmission control module (MPS6)
F2	5	Glow plug monitoring (diesel engines)

Fuses

Fuse	Ampere rating	Circuits protected
F2	5	Vaporiser glow plug monitoring (2.0L Duratorq-TDCi Stage V and 2.2L Duratorq-TDCi Stage V)
F3	70 ¹	Engine cooling fan - twin fan (2.3L Duratec-HE and 2.2L Duratorq-TDCi automatic)
F3	80 ¹	Electric hydraulic power steering (EHPAS) (1.6L EcoBoost SCTi, 2.0L EcoBoost SCTi, 1.6L Duratorq-TDCi Stage V and 2.0L Duratorq-TDCi Stage V)
F4	60	Glow plugs
F5	60	Engine cooling fan (1.6L Duratorq-TDCi, 2.0L Duratorq-TDCi, 2.0L Duratorq-TDCi Stage V, 2.2L Duratorq-TDCi manual, 2.0L Duratec-HE, 2.3L Duratec-HE and 2.0L EcoBoost SCTi)
F5	70	Engine cooling fan - twin fan (1.6L EcoBoost SCTi)
F6	7.5	HEGO sensor (1.6L Duratorq-TDCi)
F6	10	HEGO sensor, CMS Sensor, Oxygen Sensor (engine management)
F6	20	Vaporiser glow plug (2.0L Duratorq-TDCi Stage V and 2.2L Duratorq-TDCi Stage V)
F7	5	Relay coils
F8	10	Powertrain control module, fuel metering unit, MAF sensor, fuel rail pressure control valve (engine management)
F8	20	Powertrain control module (2.0L EcoBoost SCTi and 2.0L Duratorq-TDCi Stage V)
F8	15	Powertrain control module (1.6L EcoBoost SCTi, 1.6L Duratorq-TDCi and 2.2L Duratorq-TDCi Stage V)
F9	10	MAF Sensor, Fuel Injectors (engine management)
F9	5	Fuel pump vaporiser (2.0L Duratorq-TDCi Stage V)
F9	7.5	MAF Sensor, EGR bypass Valve , Fuel pump vaporiser (2.2L Duratorq-TDCi Stage V) (engine management)
F9	7.5	Degas valve, TMAF sensor, active grille shutter, bypass valve, relay coil, auxiliary run on water pump (1.6L EcoBoost SCTi)

Fuses

Fuse	Ampere rating	Circuits protected
F10	10	Engine control module (2.0L Duratorq-TDCi)
F10	7.5	Auxiliary run on, water pump (1.6L EcoBoost SCTi)
F11	10	PCV Valve, VCV Valve, Water in Fuel Sensor, Sonic Purge Valve, Swirl Control Valve, Variable Intake Valve, EGR Valve, IVVT Oil Control Valve (engine management). T.MAF sensor, variable exhaust timing valve, active grille shutter, cannister purge valve. turbo control valve, wastegate valve (engine management).
F11	10	Turbo control valve, MAF sensor, active grille shutter, EGR valve, VCV valve (1.6L Duratorq-TDCi)
F11	5	MAF sensor, water in fuel sensor, active grille shutter, inlet metering valve (2.0L Duratorq-TDCi Stage V)
F11	7.5	Fuel rail pressure, fuel metering unit, active grille shutter (2.2L Duratorq-TDCi Stage V)
F11	10	Turbo control valve, variable intake timing valve, variable exhaust timing valve, cannister purge valve, electrical bypass valve (1.6L EcoBoost SCTi)
F12	10	Coil on Plug; Canister Purge Valve, Power Steering Pressure Switch (engine management)
F12	10	EGR throttle, variable turbo control (2.0L Duratorq-TDCi)
F12	5	Relay coils (2.0L Duratorq-TDCi Stage V, 2.2L Duratorq-TDCi Stage V and 1.6L Duratorq-TDCi)
F12	15	Ignition coils (1.6L EcoBoost SCTi and 2.0L EcoBoost SCTi)
F13	15	Air conditioning
F14	15	Diesel filter heater (2.0L Duratorq-TDCi, 2.0L Duratorq-TDCi Stage V and 1.6L Duratorq-TDCi)
F14	10	HEGO sensors (2.2L Duratorq-TDCi Stage V)
F15	40	Starter relay
F16	80	Diesel auxiliary heater (PTC)
F17	60	Central fuse box supply A
F18	60	Central fuse box supply B

Fuses

Fuse	Ampere rating	Circuits protected
F19	60	Rear fuse box supply C
F20	60	Rear fuse box supply D
F21	30	VQM/non VQM: Cluster/Audio/AC/FLR
F22	30	Windscreen wiper module
F23	25	Heated rear window
F24	30	Headlamp washer
F25	30	ABS valves
F26	40	ABS pump
F27	25	Fuel fired heater
F28	40	Heater blower
F29	–	Not used
F30	5	ABS 30 feed
F31	15	Horn
F32	5	Fuel fired heater - remote control
F33	5	Light switch module, engine compartment fuse box coils
F34	40	Heated windscreen (left-hand side)
F35	40	Heated windscreen (right-hand side)
F36	15	Rear wiper 15 feed
F37	7.5	Heated front washer jets/FLR + FSM KL15
F38	10	PCM/TCM/EHPAS 15 feed
F39	15	Adaptive front lighting system (AFS)
F40	5	Headlamp levelling/AFS module
F41	20	Instrument panel
F42	5	Cluster IP
F43	15	Audio/BVC module/DAB module

Fuses

Fuse	Ampere rating	Circuits protected
F44	5	Automatic AC/Manual AC
F45	5	FLR (Start Stop)

¹Fit a replacement with the same rating as the one you have removed.

Central fuse box

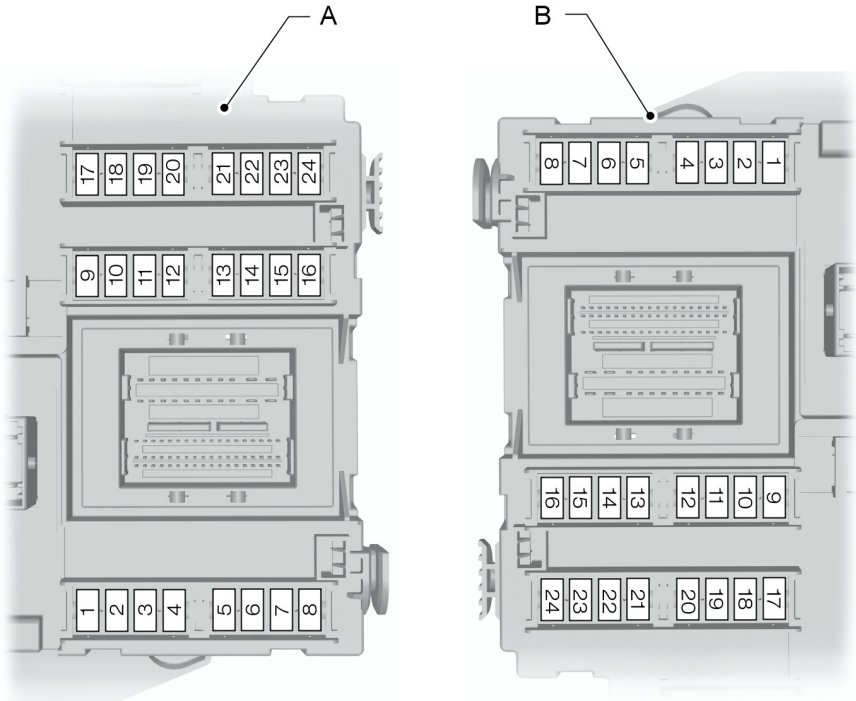

E124888

- A Left-hand drive
- B Right-hand drive

Fuses

Fuse	Ampere rating	Circuits protected
F1	7.5	Steering wheel module
F2	5	Cluster
F3	10	Interior lamps
F4	5	Engine immobiliser
F5	7.5	Adaptive cruise control (ACC)
F6	5	Rain sensor
F7	20	Cigar lighter
F8	10	Fuel filler flap unlock supply
F9	15	Windscreen washers - rear
F10	15	Windscreen washers - front
F11	10	Luggage compartment release supply
F12	10	Fuel filler flap lock supply
F13	20	Fuel pump
F13	7.5	Fuel pump (2.2L Duratorq-TDCi Stage V)
F14	5	Remote frequency receiver, Interior motion sensor
F15	5	Ignition switch
F16	5	Battery backup sounder (alarm system), OBD II (board computer diagnostics)
F17	5	Steering wheel vibration actuator
F18	10	SRS (airbag) supply
F19	7.5	ABS, yaw rate sensor (ESP), electric parking brake (EPB), accelerator pedal supply
F20	7.5	Electronic feed, electronic fuse, Auto-dimming mirror, lane departure warning
F21	15	Radio supply

Fuses

Fuse	Ampere rating	Circuits protected
F22	5	Brake lamp switch
F23	20	Sunroof
F24	5	Climate Control Module and Steering Column Unit supply

Rear fuse box

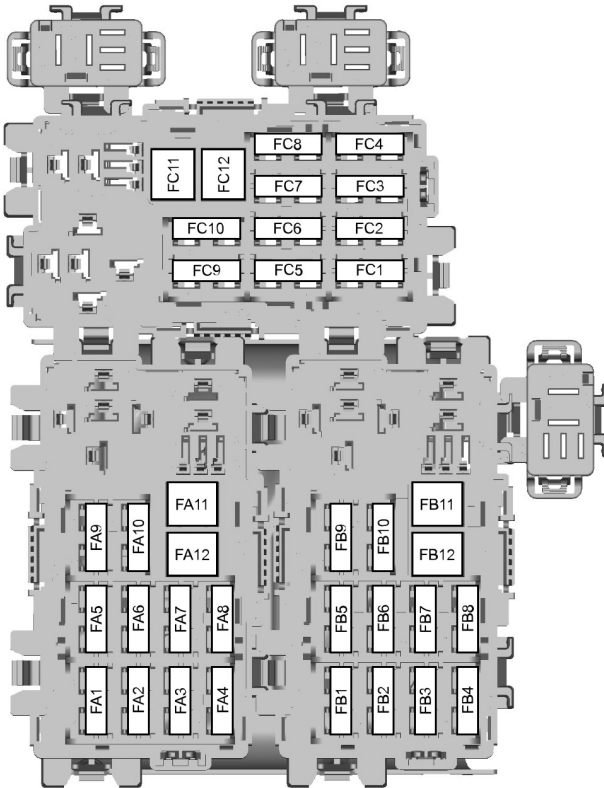

E75526

Fuses

Fuse	Ampererating	Circuits protected
FA1	25	Door module (left-hand front) (window up/down, central locking, electric folding mirror, heated mirror)
FA2	25	Door module (right-hand front) (window up/down, central locking, electric folding mirror, heated mirror)
FA3	25	Door module (left-hand rear) (window up/down)
FA4	25	Door module (right-hand rear) (window up/down)
FA5	10	Rear locking (without rear door modules)
FA6	15	Auxiliary power socket
FA7	5	Relay coils
FA8	20	Keyless vehicle module
FA9	5	Relay coils VQM (Start Stop)
FA10	-	Not used
FA11	20	Accessories, trailer module
FA12	30	Electric driver's seat
FB1	15	Sunblind system
FB2	15	Suspension module
FB3	15	Heated driver's seat
FB4	15	Heated front passenger seat
FB5	-	Not used
FB6	10	Rear climate control
FB7	-	Not used
FB8	5	Parking aid, BLIS
FB9	30	Electric front passenger seat
FB10	10	Anti-theft alarm horn
FB11	-	Not used
FB12	-	Not used
FC1	7.5	Electric rear quarter windows

Fuses

Fuse	Ampererating	Circuits protected
FC2	30	Electric parking brake (EPB)
FC3	30	Electric parking brake (EPB)
FC4	10	Rear air conditioning
FC5	20	Keyless vehicle
FC6	20	Rear air conditioning blower
FC7	5	Seat memory function module
FC8	7.5	Rear seat entertainment/CD Changer
FC9	20	Audio amplifier
FC10	10	Sony audiophile
FC11	–	Not used
FC12	–	Not used

Vehicle recovery

TOWING POINTS

Towing eye location

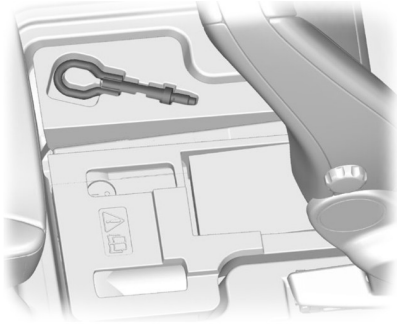

E73240

The screw-in towing eye is located in the underfloor storage compartment behind the front seats. See **Storage compartments** (page 139).

The towing eye must **always** be carried in the vehicle.

Installing the towing eye

CAUTION

 The screw-in towing eye has a **left-hand thread**. Turn it anti-clockwise to install it. Make sure that the towing eye is fully tightened.

Note: *On vehicles with a tow bar, the towing eye cannot be installed at the rear of the vehicle. Use the tow bar to tow a vehicle.*

Front towing eye

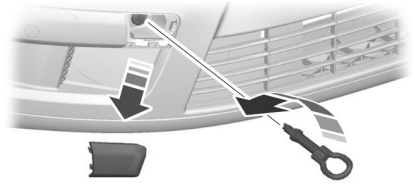

E73241

Rear towing eye

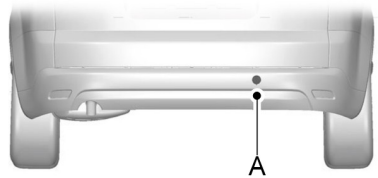

E73242

A Mount for rear towing eye

Insert a suitable object into the hole on the underside of the cover and prise off the cover.

Install the towing eye.

TOWING THE VEHICLE ON FOUR WHEELS

All vehicles

WARNINGS

 Switch the ignition on when your vehicle is being towed. The steering lock will engage and the direction indicators and brake lamps will not work if you do not.

Vehicle recovery

WARNINGS



The brake servo and the power steering pump do not operate unless the engine is running. Press the brake pedal harder and allow for increased stopping distances and heavier steering.

CAUTIONS



Too much tension in the tow rope could cause damage to your vehicle or the vehicle that is towing.



Do not use a rigid tow bar on the front towing eye.

Drive off slowly and smoothly without jerking the vehicle that is towing.

Vehicles with automatic transmission, except 2.0L Duratorq-TDCi (DW) Diesel (Stage V) or 2.0L EcoBoost SCTi (M14) with 6-Speed Automatic Transmission

CAUTIONS



Do not tow your vehicle faster than 50 km/h (30 mph) or further than 50 kilometres (30 miles).



If a speed of 50 km/h (30 mph) and a distance of 50 kilometres (30 miles) is to be exceeded the drive wheels must be lifted clear of the ground.



In the event of a mechanical failure of the transmission the drive wheels must be lifted clear of the ground.



Do not tow your vehicle backwards.



Select neutral when your vehicle is being towed.

Vehicles with 2.0L Duratorq-TDCi (DW) Diesel (Stage V) or 2.0L EcoBoost SCTi (M14) and 6-Speed Automatic Transmission

CAUTIONS



It is recommended not to tow with the drive wheels on the ground. However, if it is required to move the vehicle from a dangerous location, do not tow your vehicle faster than 20 km/h (12 mph) or further than 20 kilometres (12 miles).



If a speed of 20 km/h (12 mph) and a distance of 20 kilometres (12 miles) is to be exceeded the drive wheels must be lifted clear of the ground.



Do not tow your vehicle if the ambient temperature is below 0°C (32°F).



Do not tow your vehicle backwards.



In the event of a mechanical failure of the transmission the drive wheels must be lifted clear of the ground.



Select neutral when your vehicle is being towed.

Maintenance

GENERAL INFORMATION

Have your vehicle serviced regularly to help maintain its roadworthiness and resale value. There is a large network of Ford Authorised Repairers that are there to help you with their professional servicing expertise. We believe that their specially trained technicians are best qualified to service your vehicle properly and expertly. They are supported by a wide range of highly specialised tools developed specifically for servicing your vehicle.

In addition to regular servicing, we recommend that you carry out the following additional checks.

WARNINGS



Switch the ignition off before touching or attempting adjustment of any kind.



Do not touch the electronic ignition system parts after you have switched the ignition on or when the engine is running. The system operates at high voltage.



Keep your hands and clothing clear of the engine cooling fan. Under certain conditions, the fan may continue to run for several minutes after you have switched the engine off.

CAUTION



When carrying out maintenance checks, make sure that filler caps are fitted securely.

Daily checks

- Exterior lamps.
- Interior lamps.
- Warning lamps and indicators.

Check when refuelling

- Engine oil level. See **Engine Oil Check** (page 244).
- Brake fluid level. See **Brake and Clutch Fluid Check** (page 245).
- Washer fluid level. See **Washer Fluid Check** (page 246).
- Tyre pressures (when cold). See **Technical Specifications** (page 262).
- Tyre condition. See **Tyre Care** (page 260).

Monthly checks

- Engine coolant level (engine cold). See **Engine Coolant Check** (page 244).
- Pipes, hoses and reservoirs for leaks.
- Power steering fluid level. See **Power Steering Fluid Check** (page 245).
- Air conditioning operation.
- Parking brake operation.
- Horn operation.
- Tightness of wheel nuts. See **Technical Specifications** (page 262).

OPENING AND CLOSING THE BONNET

Opening the bonnet



E73698

Maintenance

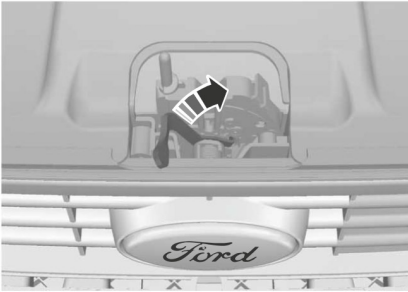

E87785

Raise the bonnet slightly and move the catch towards the left-hand side of the vehicle.

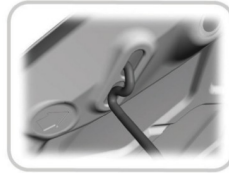

E87786

Open the bonnet and support it with the strut.

Closing the bonnet

WARNING



Make sure that the bonnet is closed properly.

Lower the bonnet and allow it to drop from under its own weight for the last 20 – 30 centimetres (8 - 11 inches).

Maintenance

UNDER BONNET OVERVIEW - 1.6L ECOBOOST SCTI (SIGMA)

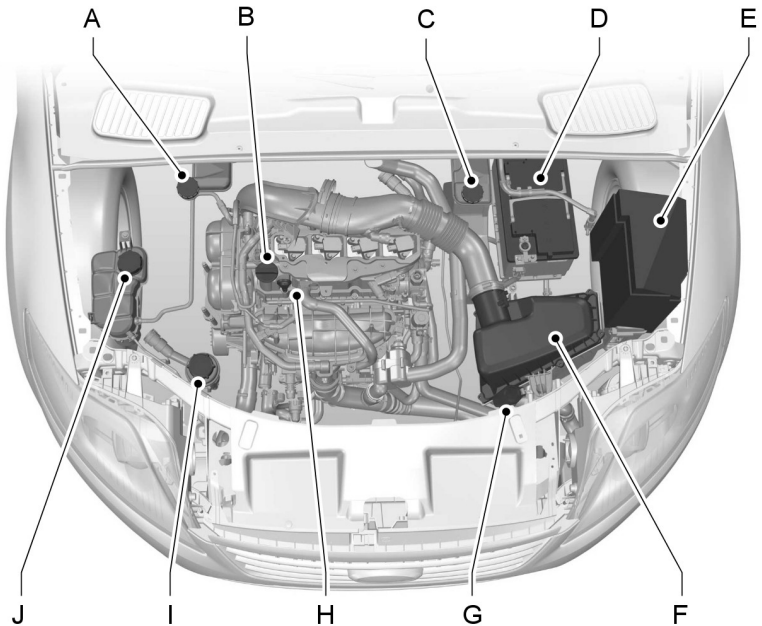

E132430

- A Brake and clutch fluid reservoir (right-hand drive). See **Brake and Clutch Fluid Check** (page 245).
- B Engine oil filler cap¹. See **Engine Oil Check** (page 244).
- C Brake and clutch fluid reservoir (left-hand drive). See **Brake and Clutch Fluid Check** (page 245).
- D Battery. See **Vehicle battery** (page 251).
- E Engine compartment fuse box. See **Fuses** (page 220).
- F Air cleaner. No maintenance necessary.
- G Screen washer fluid reservoir. See **Washer Fluid Check** (page 246).
- H Engine oil dipstick¹. See **Engine Oil Check** (page 244).

Maintenance

I Power steering fluid reservoir. See **Power Steering Fluid Check** (page 245).

J Engine coolant reservoir. See **Engine Coolant Check** (page 244).

¹The filler caps and the engine oil dipstick are coloured for easy identification.

UNDER BONNET OVERVIEW - 2.0L DURATEC-HE (MI4)

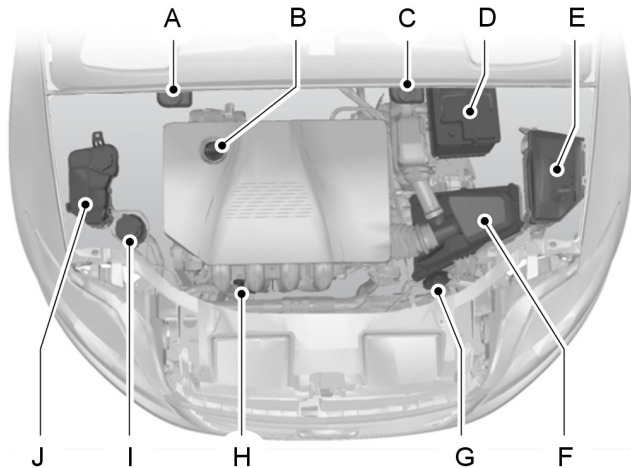

E73231

A Brake and clutch fluid reservoir (right-hand drive). See **Brake and Clutch Fluid Check** (page 245).

B Engine oil filler cap¹. See **Engine Oil Check** (page 244).

C Brake and clutch fluid reservoir (left-hand drive). See **Brake and Clutch Fluid Check** (page 245).

D Battery. See **Jump-Starting the Vehicle** (page 251).

E Engine compartment fuse box. See **Fuse Specification Chart** (page 222).

F Air cleaner. No maintenance necessary.

G Screen washer fluid reservoir. See **Washer Fluid Check** (page 246).

H Engine oil dipstick¹. See **Engine Oil Check** (page 244).

Maintenance

I Power steering fluid reservoir. See **Power Steering Fluid Check** (page 245).

J Engine coolant reservoir. See **Engine Coolant Check** (page 244).

¹The filler caps and the engine oil dipstick are coloured for easy identification.

UNDER BONNET OVERVIEW - 2.0L ECOBOOST SCTI (MI4)

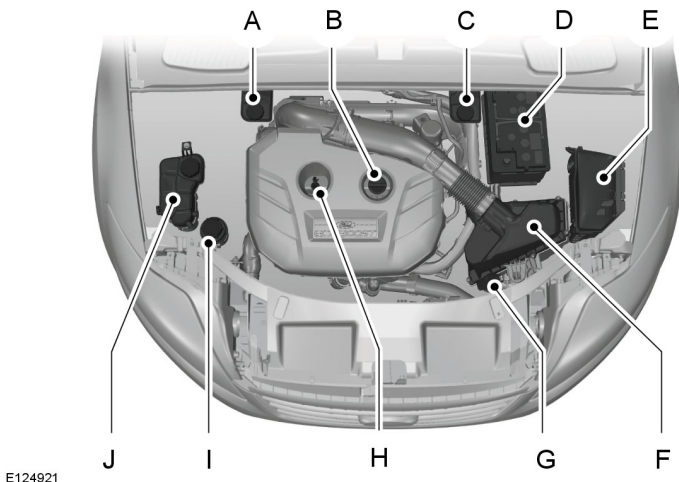

E124921

A Brake and clutch fluid reservoir (right-hand drive). See **Brake and Clutch Fluid Check** (page 245).

B Engine oil filler cap¹. See **Engine Oil Check** (page 244).

C Brake and clutch fluid reservoir (left-hand drive). See **Brake and Clutch Fluid Check** (page 245).

D Battery. See **Jump-Starting the Vehicle** (page 251).

E Engine compartment fuse box. See **Fuse Specification Chart** (page 222).

F Air cleaner. No maintenance necessary.

G Screen washer fluid reservoir. See **Washer Fluid Check** (page 246).

H Engine oil dipstick¹. See **Engine Oil Check** (page 244).

Maintenance

I Power steering fluid reservoir. See **Power Steering Fluid Check** (page 245).

J Engine coolant reservoir. See **Engine Coolant Check** (page 244).

¹The filler caps and the engine oil dipstick are coloured for easy identification.

UNDER BONNET OVERVIEW - 2.3L DURATEC-HE (MI4)

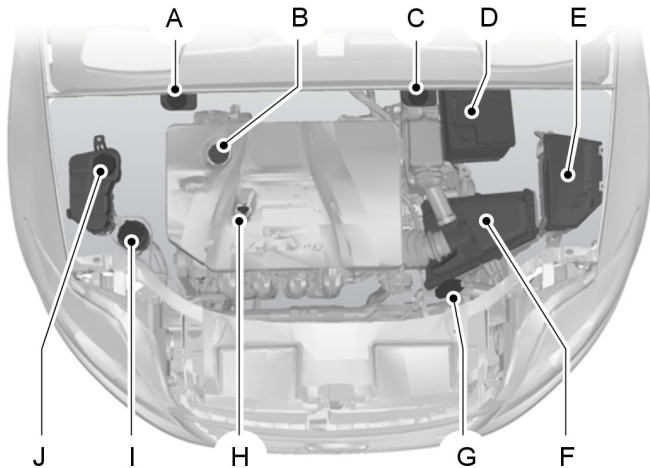

E81313

A Brake and clutch fluid reservoir (right-hand drive). See **Brake and Clutch Fluid Check** (page 245).

B Engine oil filler cap¹. See **Engine Oil Check** (page 244).

C Brake and clutch fluid reservoir (left-hand drive). See **Brake and Clutch Fluid Check** (page 245).

D Battery. See **Jump-Starting the Vehicle** (page 251).

E Engine compartment fuse box. See **Fuse Specification Chart** (page 222).

F Air cleaner. No maintenance necessary.

G Screen washer fluid reservoir. See **Washer Fluid Check** (page 246).

H Engine oil dipstick¹. See **Engine Oil Check** (page 244).

Maintenance

I Power steering fluid reservoir. See **Power Steering Fluid Check** (page 245).

J Engine coolant reservoir. See **Engine Coolant Check** (page 244).

[†]The filler caps and the engine oil dipstick are coloured for easy identification.

UNDER BONNET OVERVIEW - 1.6L DURATORQ-TDCI (DV) DIESEL

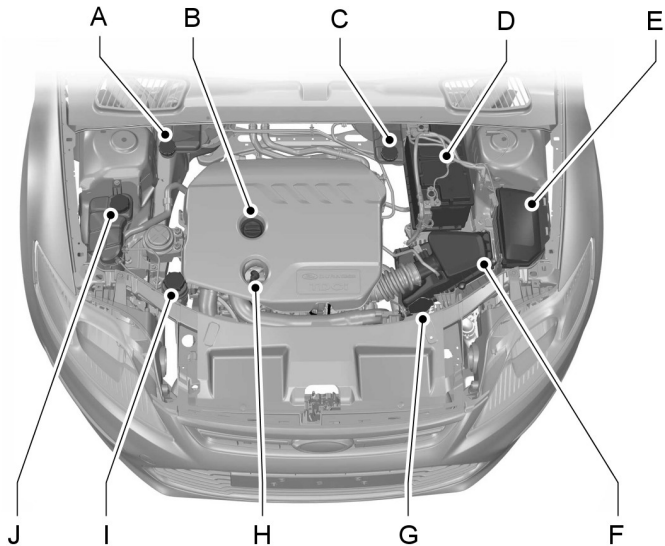

E135199

A Brake and clutch fluid reservoir (right-hand drive). See **Brake and Clutch Fluid Check** (page 245).

B Engine oil filler cap[†]. See **Engine Oil Check** (page 244).

C Brake and clutch fluid reservoir (left-hand drive). See **Brake and Clutch Fluid Check** (page 245).

D Battery. See **Vehicle battery** (page 251).

E Engine compartment fuse box. See **Fuses** (page 220).

F Air cleaner. No maintenance necessary.

G Screen washer fluid reservoir. See **Washer Fluid Check** (page 246).

Maintenance

H Engine oil dipstick¹. See **Engine Oil Check** (page 244).

I Power steering fluid reservoir. See **Power Steering Fluid Check** (page 245).

J Engine coolant reservoir. See **Engine Coolant Check** (page 244).

¹The filler caps and the engine oil dipstick are coloured for easy identification.

UNDERBONNET OVERVIEW - 2.0L DURATORQ-TDCI (DW) DIESEL

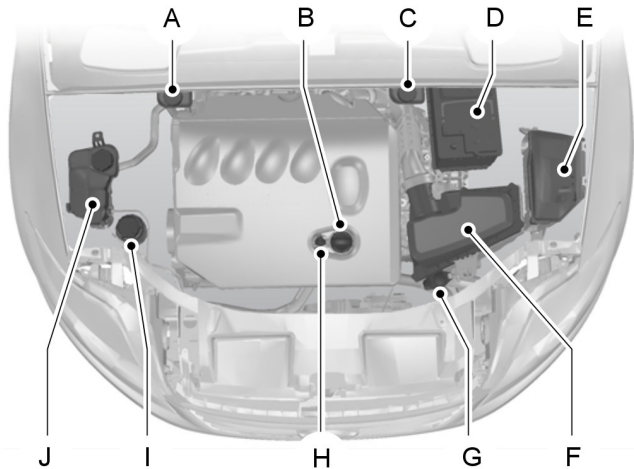

E73234

Maintenance

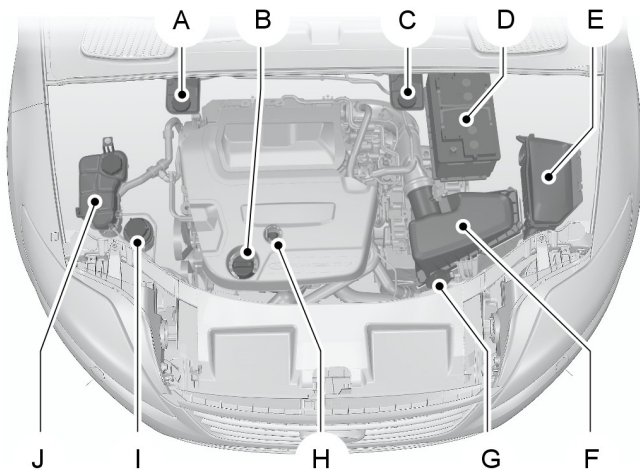

E124913

- A Brake and clutch fluid reservoir (right-hand drive). See **Brake and Clutch Fluid Check** (page 245).
- B Engine oil filler cap¹. See **Engine Oil Check** (page 244).
- C Brake and clutch fluid reservoir (left-hand drive). See **Brake and Clutch Fluid Check** (page 245).
- D Battery. See **Jump-Starting the Vehicle** (page 251).
- E Engine compartment fuse box. See **Fuse Specification Chart** (page 222).
- F Air cleaner. No maintenance necessary.
- G Screen washer fluid reservoir. See **Washer Fluid Check** (page 246).
- H Engine oil dipstick¹. See **Engine Oil Check** (page 244).
- I Power steering fluid reservoir. See **Power Steering Fluid Check** (page 245).
- J Engine coolant reservoir. See **Engine Coolant Check** (page 244).

¹The filler caps and the engine oil dipstick are coloured for easy identification.

Maintenance

UNDER BONNET OVERVIEW - 2.2L DURATORQ-TDCI (DW) DIESEL

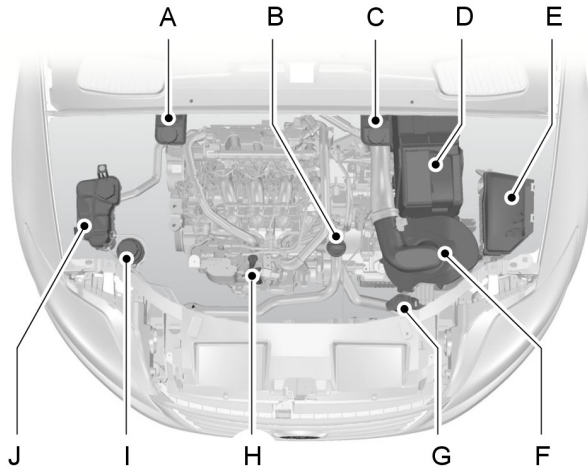

E87715

- A Brake and clutch fluid reservoir (right-hand drive): See **Brake and Clutch Fluid Check** (page 245).
- B Engine oil filler cap¹: See **Engine Oil Check** (page 244).
- C Brake and clutch fluid reservoir (left-hand drive): See **Brake and Clutch Fluid Check** (page 245).
- D Battery: See **Vehicle battery** (page 251).
- E Engine compartment fuse box: See **Fuses** (page 220).
- F Air cleaner: No maintenance necessary.
- G Screen washer fluid reservoir: See **Washer Fluid Check** (page 246).
- H Engine oil dipstick¹: See **Engine Oil Check** (page 244).
- I Power steering fluid reservoir: See **Power Steering Fluid Check** (page 245).
- J Engine coolant reservoir: See **Engine Coolant Check** (page 244).

¹The filler caps and the engine oil dipstick are coloured for easy identification.

Maintenance

ENGINE OIL DIPSTICK - 1.6L ECOBOOST SCTI (SIGMA)

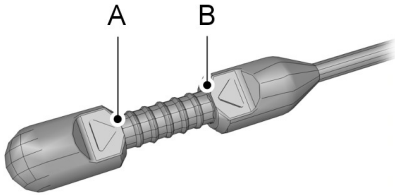

E134114

- A MIN
- B MAX

ENGINE OIL DIPSTICK - 2.0L ECOBOOST SCTI (MI4)

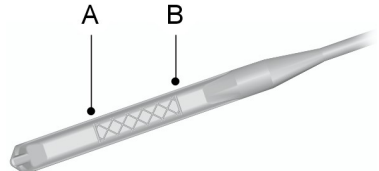

E124917

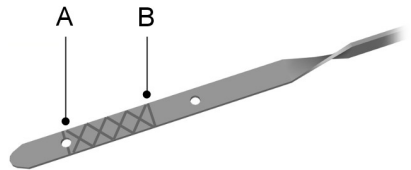

E134040

- A MIN
- B MAX

ENGINE OIL DIPSTICK - 2.0L DURATEC-HE (MI4)/2.3L DURATEC-HE (MI4)

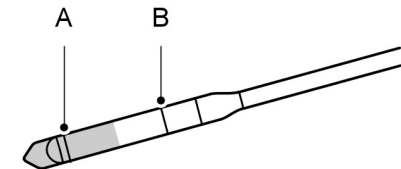

E92036

- A MIN
- B MAX

ENGINE OIL DIPSTICK - 1.6L DURATORQ-TDCI (DV) DIESEL/2.0L DURATORQ-TDCI (DW) DIESEL/2.2L DURATORQ-TDCI (DW) DIESEL

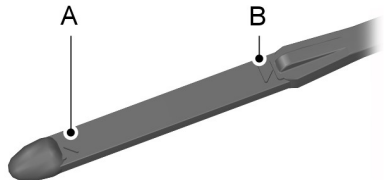

E95543

- A MIN
- B MAX

Maintenance

ENGINE OIL CHECK

CAUTION

 Do not use oil additives or other engine treatments. Under certain conditions, they could damage the engine.

Note: *The oil consumption of new engines reaches its normal level after approximately 5000 kilometres (3000 miles).*

Checking the oil level

CAUTION

 Make sure that the level is between the **MIN** and the **MAX** marks.

Note: *Check the level before starting the engine.*

Note: *Make sure that your vehicle is on level ground.*

Note: *Oil expands when it is hot. The level may therefore extend a few millimetres beyond the **MAX** mark.*

Remove the dipstick and wipe it with a clean, lint free cloth. Replace the dipstick and remove it again to check the oil level.

If the level is at the **MIN** mark, top up immediately.

Topping up

WARNINGS

 Only top up when the engine is cold. If the engine is hot, wait 10 minutes for the engine to cool down.

 Do not remove the filler cap when the engine is running.

Remove the filler cap.

WARNING

 Do not top up further than the **MAX** mark.

Note: *Soak up any spillage with an absorbent cloth immediately.*

Top up with fluid that meets the Ford specification. See **Technical Specifications** (page 246).

Replace the filler cap. Turn it until you feel a strong resistance.

ENGINE COOLANT CHECK

Checking the coolant level

WARNING

 Do not allow the fluid to touch your skin or eyes. If this happens, rinse the affected areas immediately with plenty of water and contact your doctor.

CAUTION

 Make sure that the level is between the **MIN** and the **MAX** marks.

Note: *Coolant expands when it is hot. The level may therefore extend beyond the **MAX** mark.*

If the level is at the **MIN** mark, top up immediately.

Topping up

WARNINGS

 Only top up when the engine is cold. If the engine is hot, wait 10 minutes for the engine to cool down.

 Do not remove the filler cap when the engine is running.

Maintenance

WARNINGS



Do not remove the filler cap when the engine is hot. Wait for the engine to cool down.



Undiluted coolant is flammable and may ignite if spilt on a hot exhaust.

CAUTIONS



In an emergency, you can add just water to the cooling system to reach a vehicle service station. Have the system checked by a properly trained technician as soon as possible.



Prolonged use of incorrect dilution of the coolant can cause engine damage from corrosion, overheating or freezing.

Unscrew the cap **slowly**. Any pressure will escape slowly as you unscrew the cap.

CAUTION



Do not top up further than the **MAX** mark.

Top up with a 50/50 mixture of coolant and water using fluid that meets the Ford specification. See **Technical Specifications** (page 246).

BRAKE AND CLUTCH FLUID CHECK

WARNINGS



Use of any fluid other than the recommended brake fluid may reduce brake efficiency and not meet Ford's performance standards.



Do not allow the fluid to touch your skin or eyes. If this happens, rinse the affected areas immediately with plenty of water and contact your doctor.

WARNINGS



If the level is at the **MIN** mark, have the system checked by a properly trained technician as soon as possible.

Note: *Keep brake fluid clean and dry. Contamination with dirt, water, petroleum products or other materials may result in brake system damage and possible failure.*

Note: *The brake and the clutch systems are supplied from the same reservoir.*

Top up with fluid that meets the Ford specification. See **Technical Specifications** (page 246).

POWER STEERING FLUID CHECK

WARNING



Do not allow the fluid to touch your skin or eyes. If this happens, rinse the affected areas immediately with plenty of water and contact your doctor.

CAUTION



Make sure that the level is between the **MIN** and the **MAX** marks.

If the level is at the **MIN** mark, top up immediately.

Topping up

Remove the filler cap.

CAUTION



Do not top up further than the **MAX** mark.

Top up with fluid that meets the Ford specification. See **Technical Specifications** (page 246).

Maintenance

WASHER FLUID CHECK

Note: *The front and rear washer systems are supplied from the same reservoir.*

When topping up, use a mixture of washer fluid and water to help prevent freezing in cold weather and improve the cleaning capability. We recommend that you use only high quality washer fluid.

For information on fluid dilution, refer to the product instructions.

TECHNICAL SPECIFICATIONS

Vehicle fluids

Note: *Use fluids which meet the specifications or requirements defined. Use of other fluids may lead to damage which is not covered by your Warranty.*

Item	Specification	Viscosity Grade	Recommended fluid
Engine oil - petrol engines only	WSS-M2C948-B	5W-20	Castrol or Ford Engine Oil
Alternative engine oil - all petrol engines	WSS-M2C913-C	5W-30	Castrol or Ford Engine Oil
Engine oil - diesel engines	WSS-M2C913-C	5W-30	Castrol or Ford Engine Oil
Antifreeze	WSS-M97B44-D	-	Motorcraft SuperPlus Anti-freeze
Brake fluid	WSS-M6C65-A2 or ISO 4925 Class 6	-	Motorcraft or Ford DOT 4 LV High Performance Brake Fluid
Power steering fluid	WSS-M2C204-A2	-	Ford Power Steering Fluid

Your engine has been designed to be used with Castrol and Ford Engine Oil, which gives a fuel economy benefit whilst maintaining the durability of your engine.

Topping up the oil: If you are unable to find an oil that meets the specification defined by **WSS-M2C913-C** or **WSS-M2C948-B** (petrol engines only), you must use **SAE 5W-30** that meets the specification defined by **ACEA A5/B5**.

Using topping up oils other than the one specified can result in longer engine cranking periods, reduced engine performance, reduced fuel economy and increased emission levels.

Castrol engine oil recommended.

Maintenance



Capacities

Variant	Item	Capacity in Litres (gallons)
All	Power steering system	MAX mark
All	Windscreen and rear window washer system	3.9 (0.9)
All	Fuel tank	70 (15.4)
1.6L EcoBoost SCTi (Sigma)	Engine lubrication system - including the oil filter	4.1 (0.9)
1.6L EcoBoost SCTi (Sigma)	Engine lubrication system - excluding the oil filter	3.8 (0.8)
1.6L EcoBoost SCTi (Sigma)	Engine cooling system	6.5 (1.4)
2.0L Duratec-HE	Engine lubrication system - including the oil filter	4.3 (1.0)
2.0L Duratec-HE	Engine lubrication system - excluding the oil filter	3.9 (0.9)
2.0L Duratec-HE	Engine cooling system	6.2 (1.4)
2.0L EcoBoost SCTi	Engine lubrication system - including the oil filter	5.4 (1.2)
2.0L EcoBoost SCTi	Engine lubrication system - excluding the oil filter	5.1 (1.1)
2.0L EcoBoost SCTi	Engine cooling system	approx. 6.9 (1.5)
2.3L Duratec-HE	Engine lubrication system - including the oil filter	4.3 (1.0)
2.3L Duratec-HE	Engine lubrication system - excluding the oil filter	3.9 (0.9)
2.3L Duratec-HE	Engine cooling system	6.9 (1.5)
1.6L Duratorq-TDCi	Engine lubrication system - including the oil filter	3.8 (0.8)

Maintenance

Variant	Item	Capacity in Litres (gallons)
1.6L Duratorq-TDCi	Engine lubrication system - excluding the oil filter	3.5 (0.8)
1.6L Duratorq-TDCi	Engine cooling system	7.3 (1.6)
2.0L Duratorq-TDCi	Engine lubrication system - including the oil filter	5.5 (1.2)
2.0L Duratorq-TDCi	Engine lubrication system - excluding the oil filter	5 (1.1)
2.0L Duratorq-TDCi	Engine cooling system	8.1 (1.8)
2.2L Duratorq-TDCi	Engine lubrication system - including the oil filter	6 (1.3)
2.2L Duratorq-TDCi	Engine lubrication system - excluding the oil filter	5.4 (1.2)
2.2L Duratorq-TDCi	Engine cooling system	8.4 (1.9)

Vehicle Care

CLEANING THE EXTERIOR

WARNING



If you use a car wash with a waxing cycle, make sure that you remove the wax from the windscreen.

CAUTIONS



Prior to using a car wash facility check the suitability of it for your vehicle.



Some car wash installations use water at high pressure. This could damage certain parts of your vehicle.



Remove the aerial before using an automatic car wash.



Switch the heater blower off to prevent contamination of the fresh air filter.

We recommend that you wash your vehicle with a sponge and lukewarm water containing a car shampoo.

Cleaning the headlamps

CAUTIONS



Do not scrape the headlamp lenses or use abrasives, alcoholic solvents or chemical solvents to clean them.



Do not wipe the headlamps when they are dry.

Cleaning the rear window

CAUTION



Do not scrape the inside of the rear window or use abrasives or chemical solvents to clean it.

Use a clean, lint free cloth or a damp chamois leather to clean the inside of the rear window.

Cleaning the chrome trim

CAUTION



Do not use abrasives or chemical solvents. Use soapy water.

Cleaning the alloy wheels

Note: Do not apply a cleaning chemical to warm or hot wheel rims and covers.

Note: Industrial-strength (heavy-duty) cleaners, or cleaning chemicals, in combination with brush agitation to remove brake dust and dirt, could wear away the clear coat finish over a period time.

Note: Do not use hydrofluoric acid-based or high caustic-based wheel cleaners, steel wool, fuels or strong household detergent.

Note: If you intend parking your vehicle for an extended period after cleaning the wheels with a wheel cleaner, drive your vehicle for a few minutes before doing so. This will reduce the risk of increased corrosion of the brake discs, brake pads and linings.

Note: Some automatic car washes may cause damage to the finish on your wheel rims and covers.

Alloy wheels and wheel covers are coated with a clear coat paint finish. To maintain their condition we recommend that you:

- Clean them weekly with the recommended wheel and tyre cleaner.
- Use a sponge to remove heavy deposits of dirt and brake dust accumulation.
- Rinse them thoroughly with a pressurised stream of water when you have completed the cleaning process.



We recommend that you use Ford service wheel cleaner. Make sure that you read and follow the manufacturer's instructions.

Vehicle Care

Using other non-recommended cleaning products can result in severe and permanent cosmetic damage.

Body paintwork preservation

CAUTIONS



-  Do not polish your vehicle in strong sunshine.
 -  Do not allow polish to touch plastic surfaces. It could be difficult to remove.
 -  Do not apply polish to the windscreen or rear window. This could cause the wipers to become noisy and they may not clear the window properly.
-

We recommend that you wax the paintwork once or twice a year.

CLEANING THE INTERIOR

Seat belts

WARNINGS

-  Do not use abrasives, or chemical solvents to clean them.
 -  Do not allow moisture to penetrate the seat belt retractor mechanism.
-

Clean the seat belts with interior cleaner or water applied with a soft sponge. Let the seat belts dry naturally, away from artificial heat.



Instrument cluster screens, LCD screens, radio screens

WARNING

-  Do not use abrasives, alcoholic solvents or chemical solvents to clean them.
-

Rear windows

CAUTIONS

-  Do not use any abrasive materials to clean the interior of the rear windows.
 -  Do not install stickers or labels to the interior of the rear windows.
-

REPAIRING MINOR PAINT DAMAGE

CAUTION

-  Remove apparently harmless looking substances from the paintwork immediately (e.g. bird droppings, tree resins, insect remains, tar spots, road salt and industrial fall out).
-

You should repair paintwork damage caused by stones from the road or minor scratches as soon as possible. A choice of products is available from your Ford Dealer. Read and follow the manufacturer's instructions.

Vehicle battery

JUMP-STARTING THE VEHICLE

WARNING



Do not use fuel lines, engine rocker covers or the intake manifold as grounding points.

CAUTIONS



Connect batteries with only the same nominal voltage.



Always use booster cables with insulated clamps and adequate size cable.



Do not disconnect the battery from the vehicle's electrical system.

To connect the booster cables

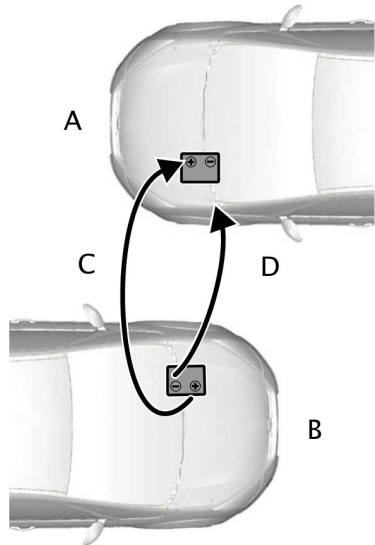

E102925

- A Flat battery vehicle
- B Booster battery vehicle
- C Positive connection cable
- D Negative connection cable

1. Position the vehicles so that they do not touch one another.
2. Switch off the engine and any electrical equipment.
3. Connect the positive (+) terminal of vehicle **B** with the positive (+) terminal of vehicle **A** (cable **C**).
4. Connect the negative (-) terminal of vehicle **B** to the ground connection of vehicle **A** (cable **D**). See **Battery connection points** (page 252).

Vehicle battery

CAUTIONS

- ⚠ **Do not connect to the negative (–) terminal of the flat battery.**
- ⚠ Make sure that the cables are clear of any moving parts and fuel delivery system parts.

To start the engine

1. Run the engine of vehicle **B** at moderately high speed.
2. Start the engine of vehicle **A**.
3. Run both vehicles for a minimum of three minutes before disconnecting the cables.

CAUTION

- ⚠ Do not switch on the headlamps when disconnecting the cables. The peak voltage could blow the bulbs.

Disconnect the cables in the reverse order.

CHANGING THE 12V BATTERY

CAUTION

- ⚠ For vehicles with Start-stop the battery requirement is different. It must be replaced by one of exactly the same specification as the original.

Note: Where applicable, the audio system must be reprogrammed with the keycode.

The battery is located in the engine compartment. See **Maintenance** (page 233).

BATTERY CONNECTION POINTS

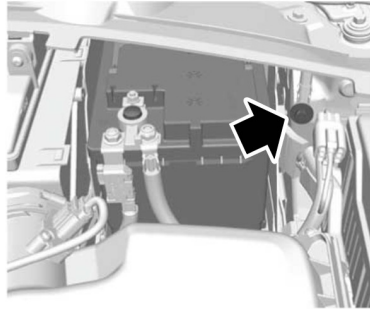

E11 4494

CAUTION

- ⚠ **Do not connect to the negative (–) terminal of the flat battery.**

Wheels and Tyres

GENERAL INFORMATION

CAUTIONS

! Use only approved wheel and tyre sizes. Using other sizes could damage the vehicle and will make the National Type Approval invalid.

! If you change the diameter of the tyres from that fitted at the factory, the speedometer may not display the correct speed. Take the vehicle to your dealer to have the engine management system reprogrammed.

! If you intend to change the size of the wheels from that fitted at the factory, check the suitability with your dealer.

Note: Check your tyre pressures regularly to optimise fuel economy.

A decal with tyre pressure data is located in the driver's door opening at the B-pillar.

Check and set the tyre pressure at the ambient temperature in which you are intending to drive the vehicle and when the tyres are cold.

CHANGING A ROAD WHEEL

Locking wheel nuts

You can obtain a replacement locking wheel nut key and replacement locking wheel nuts from your dealer using the reference number certificate.

Vehicle jack

Your vehicle is not equipped with a vehicle jack or a wheel brace.

It is recommended to use a workshop type hydraulic jack for changing between summer and winter tyres.

Jacking and lifting points

WARNING

! Never place anything between the jack and the ground, or the jack and the vehicle.

CAUTION

! Use only the specified jacking points. If you use other positions, you may damage the body, steering, suspension, engine, braking system or the fuel lines.

Note: Use a jack with a minimum lifting capacity of 1.5 tonnes and a lifting plate with a minimum diameter of 80 millimetres (3.1 inches).

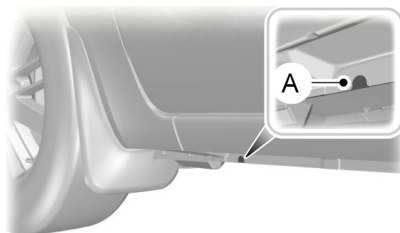
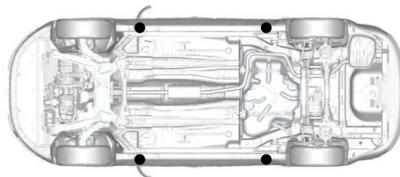
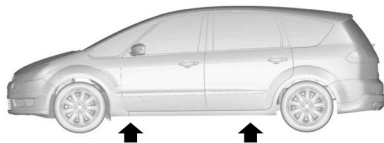

E90708

Wheels and Tyres

Indentations in the sills **A** show the location of the jacking points.



E93020

Vehicles with side skirts

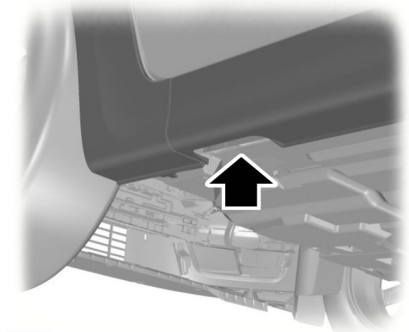



E90709









Place the lifting plate through the cut out on the underside of the skirt.

Removing a road wheel

WARNINGS

-  Park your vehicle in such a position that neither the traffic nor you are hindered or endangered.
-  Set up a warning triangle.

WARNINGS

-  Make sure that the vehicle is on firm, level ground with the wheels pointing straight ahead.
-  Switch off the ignition and apply the parking brake.
-  If your vehicle has a manual transmission, select first or reverse gear. If it has an automatic transmission, select park.
-  Have the passengers leave the vehicle.
-  Secure the diagonally opposite wheel with an appropriate block or wheel chock.
-  Make sure that the arrows on directional tyres point in the direction of rotation when the vehicle is moving forwards. If you have to fit a spare wheel with the arrows pointing in the opposite direction, have the tyre refitted in the correct direction by a properly trained technician.
-  Do not work underneath the vehicle when it is supported only by a jack.
-  Make sure that the jack is vertical to the jacking point and the base is flat on the ground.

CAUTION

-  Do not lay alloy wheels face down on the ground, this will damage the paint.

1. Remove the hub cap or cover.

Wheels and Tyres



E71948

2. Install the locking wheel nut key.
3. Slacken the wheel nuts.
4. Jack up the vehicle until the tyre is clear of the ground.
5. Remove the wheel nuts and the wheel.

Installing a road wheel

WARNINGS

 Use only approved wheel and tyre sizes. Using other sizes could damage the vehicle and will make the National Type Approval invalid. See **Technical Specifications** (page 262).

 Do not fit run flat tyres on vehicles that were not originally fitted with them. Please contact your dealer for more details regarding compatibility.

CAUTION

 Do not install alloy wheels using wheel nuts designed for use with steel wheels.

Note: The wheel nuts of alloy wheels and spoked steel wheels can also be used for the steel spare wheel for a short time (maximum two weeks).

Note: You can use wheel nuts designed for use with alloy wheels with steel wheels.

Note: Make sure the wheel and hub contact surfaces are free from foreign matter.

Note: Make sure that the cones on the wheel nuts are against the wheel.

1. Install the wheel.
2. Install the wheel nuts finger tight.



E71948

3. Install the locking wheel nut key.

Wheels and Tyres

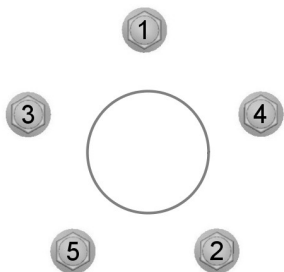

E75442

4. Partially tighten the wheel nuts in the sequence shown.
5. Lower the vehicle and remove the jack.
6. Fully tighten the wheel nuts in the sequence shown. See **Technical Specifications** (page 262).
7. Install the hub cap or cover using the ball of your hand.

WARNING



Have the wheel nuts checked for tightness and the tyre pressure checked as soon as possible.

TEMPORARY MOBILITY KIT

Your vehicle is not equipped with a spare tyre, but does include an emergency tyre repair kit that can be used to repair **one** flat tyre.

The tyre repair kit is located in the underfloor storage compartment. See **Storage compartments** (page 139).

Note: Remove the underfloor storage compartment screws if fitted.

General information

WARNINGS



Depending on the type and extent of tyre damage, some tyres can only be partially sealed or not sealed at all.

Loss of tyre pressure can affect vehicle handling, leading to loss of vehicle control.



Do not use the tyre repair kit if the tyre has already been damaged as a result of being driven under inflated.



Do not use the tyre repair kit on run flat tyres.



Do not try to seal damage other than that located within the visible tread of the tyre.



Do not try to seal damage to the tyre's sidewall.

The tyre repair kit seals most tyre punctures [with a diameter of up to six millimetres (1/4 inch)] to temporarily restore mobility.

Observe the following rules when using the kit:

- **Drive with caution and avoid making sudden steering or driving manoeuvres**, especially if the vehicle is heavily loaded or you are towing a trailer.
- The kit will provide you with an emergency temporary repair, enabling you to continue your journey to the next vehicle or tyre dealer, or to drive a maximum distance of 200 kilometres (125 miles).
- Do not exceed a **maximum speed of 80 km/h (50 mph)**.
- Keep the kit out of the reach of children.
- Only use the kit when the ambient temperature is between -30°C (-22°F) and $+70^{\circ}\text{C}$ ($+158^{\circ}\text{F}$).

Wheels and Tyres

Using the tyre repair kit

WARNINGS

 Compressed air can act as an explosive or propellant.

 Never leave the tyre repair kit unattended while in use.

CAUTION

 Do not keep the compressor operating for more than 10 minutes.

Note: Use the tyre repair kit only for the vehicle with which it was supplied.

- Park your vehicle at the roadside so that you do not obstruct the flow of traffic and so that you are able to use the kit without being in danger.
- Apply the parking brake, even if you have parked on a level road, to make sure that the vehicle will not move.
- Do not attempt to remove foreign objects like nails or screws penetrating the tyre.
- Leave the engine running while the kit is in use, but not if the vehicle is in an enclosed or poorly ventilated area (for example, inside a building). In these circumstances, switch the compressor on with the engine turned off.
- Replace the sealant bottle with a new one before the expiry date (see top of bottle) is reached.
- Inform all other users of the vehicle that the tyre has been temporarily sealed with the tyre repair kit and make them aware of the special driving conditions to be observed.

Inflating the tyre

WARNINGS

 Check the sidewall of the tyre prior to inflation. If there are any cracks, bumps or similar damage, do not attempt to inflate the tyre.

 Do not stand directly beside the tyre while the compressor is pumping.

 Watch the sidewall of the tyre. If any cracks, bumps or similar damage appear, turn off the compressor and let the air out by means of the pressure relief valve **B**. Do not continue driving with this tyre.

 The sealant contains natural rubber latex. Avoid contact with skin and clothing. If this happens, rinse the affected areas immediately with plenty of water and contact your doctor.

 If the tyre inflation pressure does not reach 1.8 bar (26 psi) within seven minutes, the tyre may have suffered excessive damage, making a temporary repair impossible. In this case, do not continue driving with this tyre.

CAUTION

 Screwing the bottle onto the bottle holder will pierce the seal of the bottle. Do not unscrew the bottle from the holder as the sealant will escape.

Wheels and Tyres

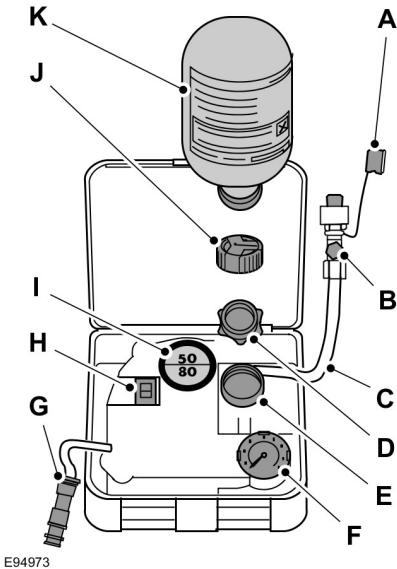

E94973

- A Protective cap
- B Pressure relief valve
- C Hose
- D Orange cap
- E Bottle holder
- F Pressure gauge
- G Power plug with cable
- H Compressor switch
- I Label
- J Bottle lid
- K Sealant bottle

1. Open the lid of the tyre repair kit.

2. Peel off the label **I** showing the maximum permissible speed of 80 km/h (50 mph) from the casing and attach it to the instrument panel in the driver's field of view. Make sure the label does not obscure anything important.
3. Take the hose **C** and the power plug with cable **G** out of the kit.
4. Unscrew the orange cap **D** and the bottle lid **J**.
5. Screw the sealant bottle **K** clockwise into the bottle holder **E** fully tight.
6. Remove the valve cap from the damaged tyre.
7. Detach the protective cap **A** from the hose **C** and screw the hose **C** firmly onto the valve of the damaged tyre.
8. Make sure that the compressor switch **H** is in position **O**.
9. Insert the power plug **G** into the cigar lighter socket or auxiliary power socket. See **Cigar Lighter** (page 137). See **Auxiliary Power Points** (page 137).
10. Start the engine.
11. Move the compressor switch **H** to position **1**.
12. Inflate the tyre for no longer than seven minutes to an inflation pressure of minimum 1.8 bar (26 psi) and a maximum of 3.5 bar (51 psi). Move the compressor switch **H** to position **O** and check the current tyre pressure with pressure gauge **F**.
13. Remove the power plug **G** from the cigar lighter socket or auxiliary power socket.
14. Quickly unscrew the hose **C** from the tyre valve and replace the protective cap **A**. Fasten the valve cap again.
15. Leave the sealant bottle **K** in the bottle holder **E**.

Wheels and Tyres

16. Make sure the kit, the bottle lid and the orange cap are stored safely, but still easily accessible in the vehicle. The kit will be required again when you check the tyre pressure.
 17. Immediately drive approximately three kilometres (two miles) so that the sealant can seal the damaged area.
6. Once you have inflated the tyre to its correct tyre pressure, move the compressor switch **H** to position **O**, remove the power plug **G** from the socket, unscrew the hose **C**, fasten the valve cap and replace the protective cap **A**.
 7. Leave the sealant bottle **K** in the bottle holder **E** and store the kit away safely in its original location.

Note: When pumping in the sealant through the tyre valve, the pressure may rise up to 6 bar (87 psi) but will drop again after about 30 seconds.

WARNING



If you experience heavy vibrations, unsteady steering behaviour or noises while driving, reduce your speed and drive with caution to a place where it is safe for you to stop the vehicle. Recheck the tyre and its pressure. If the tyre pressure is less than 1.3 bar (19 psi) or if there are any cracks, bumps or similar damage visible, do not continue driving with this tyre.

Checking the tyre pressure

1. Stop the vehicle after driving approximately three kilometres (two miles). Check, and where necessary, adjust the pressure of the damaged tyre.
2. Attach the kit and read the tyre pressure from the pressure gauge **F**.
3. If the pressure of the sealant-filled tyre is 1.3 bar (19 psi) or more, adjust it to the specified pressure. See **Technical Specifications** (page 262).
4. Follow the inflation procedure once again to top up the tyre.
5. Check the tyre pressure again from the pressure gauge **F**. If the tyre pressure is too high, deflate the tyre to the specified pressure using the pressure relief valve **B**.

8. Drive to the nearest tyre specialist to get the damaged tyre replaced. Before the tyre is removed from the rim, inform your tyre dealer that the tyre contains sealant. Renew the kit as soon as possible after it has been used once.

Note: Remember that emergency roadside tyre repair kits only provide temporary mobility. Regulations concerning tyre repair after usage of tyre repair kit may differ from country to country. You should consult a tyre specialist for advice.

WARNING



Before driving, make sure the tyre is adjusted to the recommended inflation pressure. See **Technical Specifications** (page 262). Monitor the tyre pressure until the sealed tyre is replaced.

Empty sealant bottles can be disposed of together with normal household waste. Return remains of sealant to your dealer or dispose of it in compliance with local waste disposal regulations.

Wheels and Tyres

TYRE CARE



E70415

To make sure the front and rear tyres of your vehicle wear evenly and last longer, we recommend that you swap the tyres from front to rear and vice versa at regular intervals of between 5000 and 10000 kilometres (3000 and 6000 miles).

CAUTION

 Do not scrub the sidewalls of the tyres when you are parking.

If you have to mount a kerb, do so slowly and approach it with the wheels at right-angles to the kerb.

Examine the tyres regularly for cuts, foreign objects and uneven wear of the tread. Uneven wear could mean that the wheel alignment is outside specification.

Check the tyre pressures (including the spare) when cold, every two weeks.

USING WINTER TYRES



CAUTION

 Make sure that you use the correct wheel nuts for the type of wheel the winter tyres are fitted to.

If winter tyres are used, make sure that the tyre pressures are correct. See **Technical Specifications** (page 262).

USING SNOW CHAINS

WARNINGS

-  Do not exceed 50 km/h (30 mph).
-  Do not use snow chains on snow-free roads.
-  Only fit snow chains to specified tyres. See **Technical Specifications** (page 262).

CAUTION

-  If your vehicle is fitted with wheel trims, remove them before fitting snow chains.

Note: *The ABS will continue to operate normally.*

Only use small link snow chains.



Only use snow chains on the front wheels.

Vehicles with stability control (ESP)

Vehicles with stability control (ESP) may exhibit some unusual driving characteristics which can be reduced by switching traction control off. See **Using Stability Control** (page 169).

TYRE PRESSURE MONITORING SYSTEM

WARNINGS

-  The system does not relieve you of your responsibility to regularly check the tyre pressures.
-  The system will only provide a low tyre pressure warning. It will not inflate the tyres.

Wheels and Tyres

WARNINGS



The system may take longer to detect low pressure in the tyres if you have fitted snow chains.



Do not drive on significantly under-inflated tyres. This may cause the tyres to overheat and fail.

Under-inflation reduces fuel efficiency, tyre tread life and may also affect your ability to drive the vehicle safely.



Do not bend or damage the valves when you are inflating the tyres.



Have tyres installed by properly trained technicians.

Note: After changing the tyres or sensors the system will take a few minutes to reset. During this period the system is operational but a warning lamp may appear.

Note: If you fit tyres that do not have monitoring sensors, a message will be shown in the display. See **Information Messages** (page 101). Confirm this message to deactivate the system.

The system monitors the pressure in the tyres using sensors located on the wheels and a receiver located in your vehicle.

When the system detects low pressure in the tyres, a warning message is displayed in the information display. See

Information Messages (page 101).

If a low pressure warning message is displayed in the information display, check the tyre pressures as soon as possible and inflate them to the recommended pressure. See **Technical Specifications** (page 262). If this happens frequently, have the cause determined and rectified as soon as possible.

Checking the tyre pressures

Note: If the tyre pressures are greater than or equal to 3.3 bar (48 lbf/in²), you will see the **+** symbol below the pressure value. The system only measures pressure up to 3.3 bar (48 lbf/in²). The **+** symbol indicates that the tyre pressures may be higher.

Note: Type 3 instrument clusters have a slightly different menu structure. Select **Settings** first to access **Information**.

1. Press the right arrow button on the steering wheel to enter the main menu.
2. Highlight **Information** with the up and down buttons and press the right arrow button.
3. Highlight **Tyre Pressures** with the up and down buttons and press the right arrow button.
4. Highlight the desired setting and press the **OK** button to confirm the setting.
5. Press the left arrow button to exit the menu. Hold the left arrow button pressed to return to the trip computer display.

Setting the vehicle load

Note: Type 3 instrument clusters have a slightly different menu structure. Select **Settings** first to access **Setup**.

Correct tyre pressure settings depend on vehicle load. See **Technical Specifications** (page 262). The system can only detect low pressure if you have entered the current vehicle load.

1. Press the right arrow button on the steering wheel to enter the main menu.
2. Highlight **Setup** with the up and down buttons and press the right arrow button.
3. Highlight **Tyre Pressures** with the up and down buttons and press the right arrow button.

Wheels and Tyres

4. Highlight the desired setting and press the **OK** button to confirm the setting.
5. Press the left arrow button to exit the

menu. Hold the left arrow button pressed to return to the trip computer display.

TECHNICAL SPECIFICATIONS

Wheel nut torque

Wheel type	Nm (lb-ft)
All	170 (125)

Wheels and Tyres

Tyre pressures (cold tyres)

Up to 160 km/h (100 mph)

Variant	Tyre size	Normal load		Full load	
		Front	Rear	Front	Rear
		bar (lbf/in ²)	bar (lbf/in ²)	bar (lbf/in ²)	bar (lbf/in ²)
1.6L EcoBoost SCTi (Sigma), 2.0L EcoBoost SCTi (MI4), 1.6L Duratorq-TDCi (DV) Diesel Stage V, 2.0L Duratorq-TDCi (DW) and 2.2L Duratorq-TDCi (DW)	215/60 R 16*	2.4 (35)	2.4 (35)	2.6 (38)	3.1 (45)
1.6L EcoBoost SCTi (Sigma), 2.0L EcoBoost SCTi (MI4), 1.6L Duratorq-TDCi (DV) Diesel Stage V, 2.0L Duratorq-TDCi (DW) and 2.2L Duratorq-TDCi (DW)	225/50 R 17 and 235/45 R 18	2.4 (35)	2.2 (32)	2.6 (38)	3.1 (45)
2.0L Duratec-HE (MI4) and 2.3L Duratec-HE (MI4)	215/60 R 16*	2.2 (32)	2.4 (35)	2.6 (38)	3.1 (45)
2.0L Duratec-HE (MI4) and 2.3L Duratec-HE (MI4)	225/50 R 17 and 235/45 R 18	2.2 (32)	2.2 (32)	2.6 (38)	3.1 (45)

*Only fit snow chains to specified tyres.

Wheels and Tyres

Continuous speed in excess of 160 km/h (100 mph)

Variant	Tyre size	Normal load		Full load	
		Front	Rear	Front	Rear
		bar (lbf/in ²)	bar (lbf/in ²)	bar (lbf/in ²)	bar (lbf/in ²)
1.6L EcoBoost SCTi (Sigma), 1.6L Duratorq-TDCi (DV) Diesel Stage V and 2.0L Duratorq-TDCi (DW)	215/60 R 16	2.5 (36)	2.4 (35)	2.7 (39)	3.1 (45)
1.6L EcoBoost SCTi (Sigma), 1.6L Duratorq-TDCi (DV) Diesel Stage V and 2.0L Duratorq-TDCi (DW)	225/50 R 17 and 235/45 R 18	2.5 (36)	2.3 (33)	2.7 (39)	3.1 (45)
2.0L Duratec-HE (MI4) and 2.3L Duratec-HE (MI4)	215/60 R 16	2.4 (35)	2.4 (35)	2.6 (38)	3.1 (45)
2.0L Duratec-HE (MI4) and 2.3L Duratec-HE (MI4)	225/50 R 17 and 235/45 R 18	2.4 (35)	2.2 (32)	2.6 (38)	3.1 (45)
2.0L EcoBoost SCTi (MI4) and 2.2L Duratorq-TDCi (DW)	215/60 R 16	2.6 (38)	2.6 (38)	2.8 (41)	3.3 (48)
2.0L EcoBoost SCTi (MI4) and 2.2L Duratorq-TDCi (DW)	225/50 R 17 and 235/45 R 18	2.6 (38)	2.6 (38)	2.8 (41)	3.4 (49)

Vehicle identification

VEHICLE IDENTIFICATION PLATE

Note: The vehicle identification plate design may vary to that shown.

Note: The information shown on the vehicle identification plate is dependant upon market requirements.

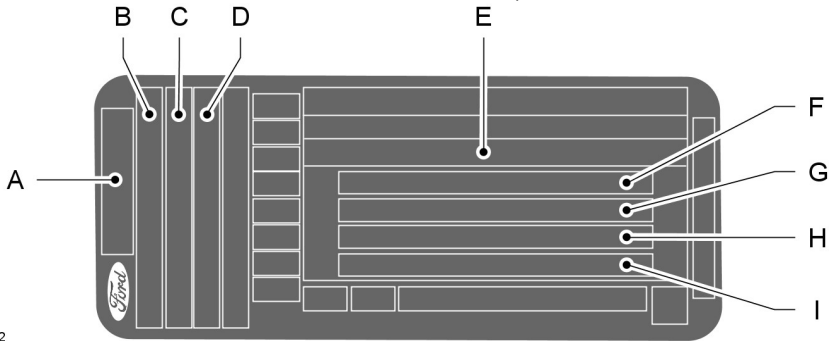

E135662

- A Model
- B Variant
- C Engine designation
- D Emission level
- E Vehicle identification number
- F Gross vehicle weight
- G Gross train weight
- H Maximum front axle weight
- I Maximum rear axle weight

The vehicle identification number and maximum weights are shown on a plate located on the lock side of the right-hand door aperture at the bottom.

Vehicle identification

VEHICLE IDENTIFICATION NUMBER

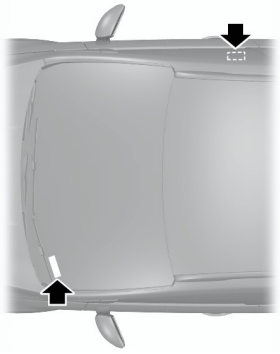

E87496

The vehicle identification number is stamped into the floor panel on the right-hand side, beside the front seat. It is also shown on the left-hand side of the instrument panel.

Capacities and Specifications

TECHNICAL SPECIFICATIONS

Vehicle dimensions

S-MAX

Dimension description	Dimension in mm (inches)
Maximum length - without bumper styling kit	4772 (187.9)
Maximum length - with bumper styling kit	4801 (189)
Overall width including exterior mirrors	2154 (84.8)
Overall height - EC kerb weight	1620 - 1660 (63.8 - 65.4)
Wheelbase	2850 (112.2)
Front track	1578 - 1588 (62.1 - 62.5)
Rear track	1595 - 1605 (62.8 - 63.2)

Galaxy

Dimension description	Dimension in mm (inches)
Maximum length	4819 (189.7)
Overall width including exterior mirrors	2154 (84.8)
Overall height - EC kerb weight without roof bars	1709 - 1758 (67.3 - 69.2)
Overall height - EC kerb weight including roof bars	1770 - 1811 (69.7 - 71.3)
Wheelbase	2850 (112.2)
Front track	1578 - 1588 (62.1 - 62.5)
Rear track	1595 - 1605 (62.8 - 63.2)

Capacities and Specifications

Towing equipment dimensions

S-MAX

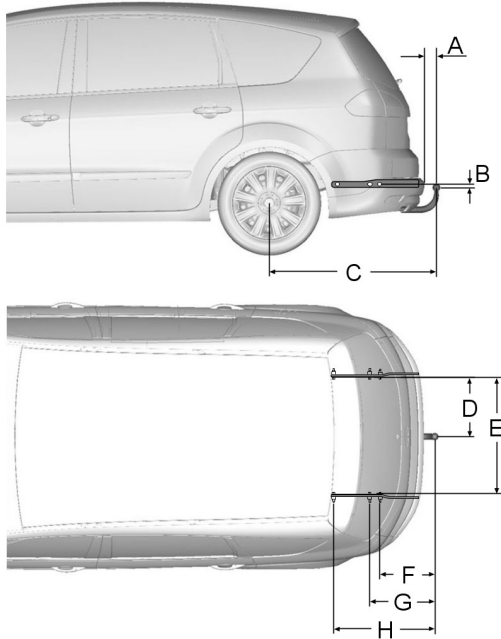

E75182

Item	Dimension description	Dimension in mm (inches)
A	Bumper – end of tow ball	102 (4)
B	Attachment point – centre of tow ball	16 (0.63)
C	Wheel centre – centre of tow ball	1 079 (42.48)
D	Centre of tow ball – side member	438 (17.2)
E	Inner side of side member	876 (34.5)

Capacities and Specifications

Item	Dimension description	Dimension in mm (inches)
F	Centre of tow ball – centre 1. attachment point	363 (14.29)
G	Centre of tow ball – centre 2. attachment point	424 (16.69)
H	Centre of tow ball – centre 3. attachment point	636 (25.04)

Galaxy

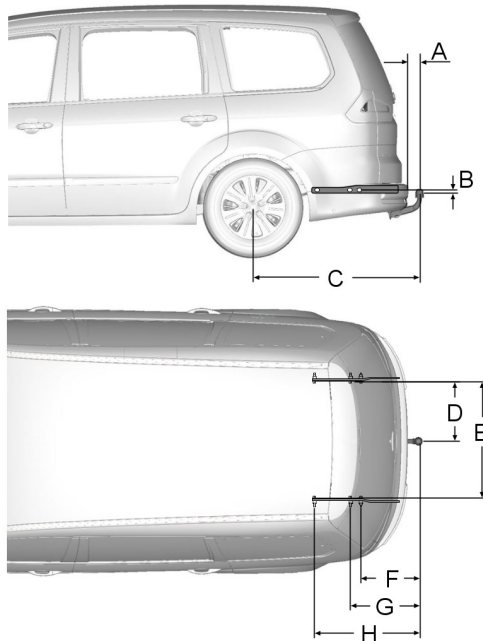

E75181





Capacities and Specifications

Item	Dimension description	Dimension in mm (inches)
A	Bumper – end of tow ball	101 (3.98)
B	Attachment point – centre of tow ball	16 (0.63)
C	Wheel centre – centre of tow ball	1128 (44.41)
D	Centre of tow ball – side member	438 (17.2)
E	Inner side of side member	876 (34.5)
F	Centre of tow ball – centre 1. attachment point	412 (16.22)
G	Centre of tow ball – centre 2. attachment point	473 (18.62)
H	Centre of tow ball – centre 3. attachment point	685 (26.97)

Audio introduction

IMPORTANT AUDIO INFORMATION

WARNINGS

-  Due to technical incompatibility, recordable (CD-R) and rewritable (CD-RW) discs may not function correctly.
-  These units will play compact discs that conform to the International Red Book standard audio specification. Copy protected CDs from some manufacturers do not conform to this standard and playback cannot be guaranteed.
-  Dual format, dual sided discs (DVD Plus, CD-DVD format), adopted by the music industry, are thicker than normal CDs and consequently playback cannot be guaranteed, and jamming could occur. Irregular shaped CDs and CDs with a scratch protection film or self adhesive labels attached should not be used. Warranty claims, where this type of disc is found to be inside an audio unit returned for repair, will not be accepted.
-  All units except Sony CD (but not the 6CD) are designed to play commercially pressed 12 cm audio compact discs only. The Sony CD unit will play 8 cm discs with a Sony approved adaptor fitted (CSA-8).
-  The audio unit may be damaged if unsuitable items like credit cards or coins are pushed inside the CD aperture.

Audio unit labels

CLASS 1
LASER PRODUCT

CAUTION—INVISIBLE LASER RADIATION WHEN OPEN
DO NOT STARE INTO BEAM OR
VIEW DIRECTLY WITH OPTICAL INSTRUMENTS

Disc labels

Audio CD

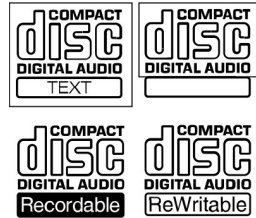

MP3



Audio unit overview

6000CD

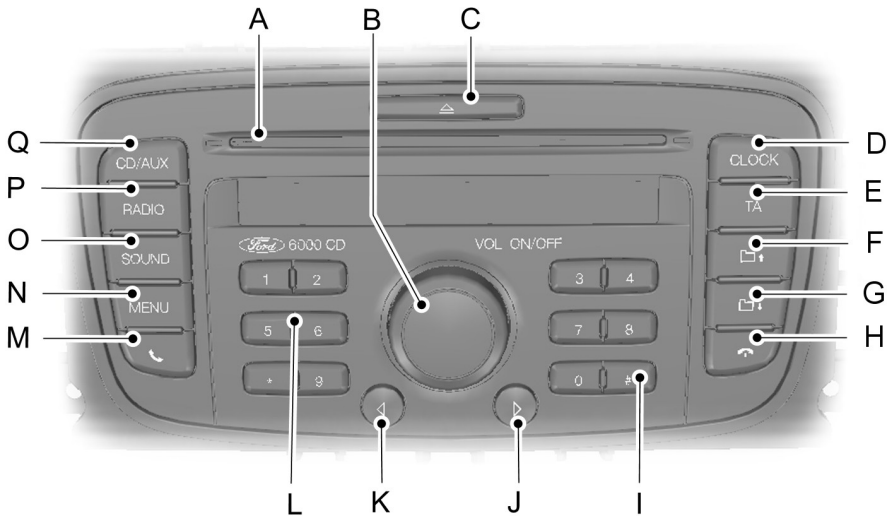

E141803

- A CD aperture. See **Loading compact discs** (page 286).
- B On, off and volume control. See **On/off control** (page 277).
- C CD eject. See **Ejecting compact discs** (page 288).
- D Clock. See **Setting the clock and date on the audio unit** (page 276).
- E Traffic announcement. See **Traffic information control** (page 280).
- F Folder up.
- G Folder down.
- H End call. See **Telephone** (page 293).
- I Information. See **MP3 display options** (page 290).
- J Seek up. See **Station tuning control** (page 281).
- K Seek down. See **Station tuning control** (page 281).
- L Station presets. See **Station preset buttons** (page 279).
- M Accept call. See **Telephone** (page 293).
- N Menu. See **Audio menu control** (page 277).

Audio unit overview

- O Bass and treble control. See **Bass/treble control** (page 277). Balance and fade control. See **Balance/fade control** (page 277).
- P Radio and waveband select. See **Waveband button** (page 279).
- Q Auxiliary and CD select. See **Auxiliary input (AUX IN) socket** (page 291). See **Compact Disc Player** (page 286).

Sony CD and Sony CD DAB

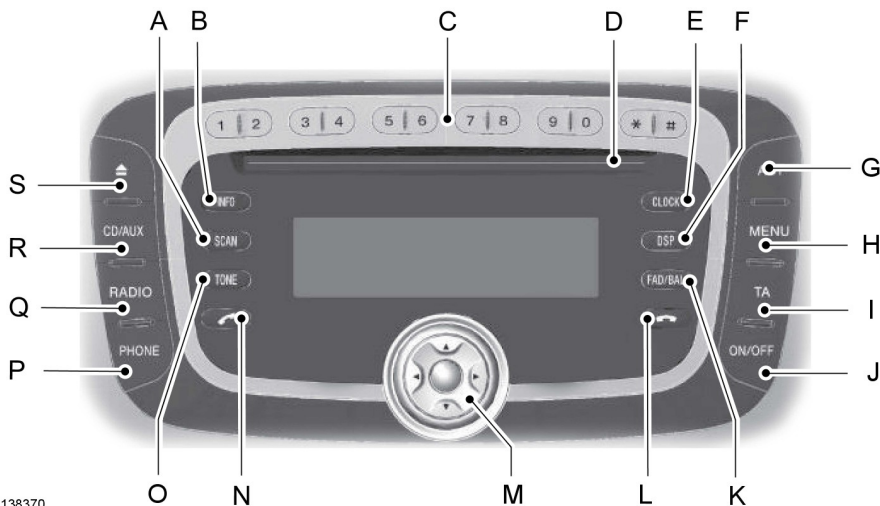

E138370

- A Scan. See **Station tuning control** (page 281). See **Compact disc track scanning** (page 288).
- B Information. See **MP3 display options** (page 290).
- C Station presets. See **Station preset buttons** (page 279).
- D CD aperture. See **Loading compact discs** (page 286).
- E Clock. See **Setting the clock and date on the audio unit** (page 276).
- F DSP select. See **Digital signal processing (DSP)** (page 283).
- G Autostore. See **Autostore control** (page 279).
- H Menu. See **Audio menu control** (page 277).
- I Traffic announcement. See **Traffic information control** (page 280).
- J On and off control. See **On/off control** (page 277).

Audio unit overview

- K Balance and fade control. See **Balance/fade control** (page 277).
- L End call. See **Telephone** (page 293).
- M Volume control, navigation buttons and select button.
- N Accept call. See **Telephone** (page 293).
- O Tone. See **Bass/treble control** (page 277).
- P Phone menu. See **Telephone** (page 293).
- Q Radio and waveband select. See **Waveband button** (page 279).
- R Auxiliary and CD select. See **Auxiliary input (AUX IN) socket** (page 291). See **Compact Disc Player** (page 286).
- S CD eject. See **Ejecting compact discs** (page 288).

Audio System Security

SECURITY CODE

Each unit incorporates a unique code that must be entered before the unit will operate.

If the battery is disconnected or if the unit has been removed from the vehicle, the code must be re-entered before the unit will operate.

LOST SECURITY CODE

If you lose the unique code, contact your dealer and supply details of your audio unit along with some proof of identity.

ENTERING A SECURITY CODE

If **CODE ----**, **CODE 0000** or **ENTER KEYCODE** appears in the display when you switch on the audio unit, you must enter the unique code using the station preset buttons.

6000CD, Sony and Sony DAB

1. Using the station preset buttons enter the unique code.
2. If you make a mistake entering the code, re-enter the digits by continuing to select buttons 0-9. The display will advance from digit position 1 to 4 and then back again.
3. Make sure that the complete code is correct before pressing either the ***** preset button or the button between the navigation buttons to confirm your selection.

INCORRECT SECURITY CODE

Up to a maximum of 10 unique code entry attempts are allowed with various consequences if you get it wrong.

The number of attempts will be shown in the display.

If the display reverts to **CODE** another entry attempt may be made immediately.

If the display shows **WAIT 30**, the unit will be locked for 30 minutes. Wait until the timer counts down to zero. When **CODE** is shown in the display, enter the correct code.

Note: *After 10 incorrect attempts the unit will be permanently inoperative and **LOCKED** will be shown in the display. See your dealer.*

Audio Unit Clock and Date Displays

SETTING THE CLOCK AND DATE ON THE AUDIO UNIT

6000CD

Changing the date and time

Press the **CLOCK** button to display the date and time.

Note: *If you do not press another button within 30 seconds of pressing the **CLOCK** button, the display will return to its previous setting.*

1. Using the seek up or seek down button select the date or time value that you wish to change. The selected value will flash in the display.
2. Rotate the volume control to change the selected date or time value.
3. Using the seek up or seek down button select additional date or time values that you wish to change.
4. Rotate the volume control to change the selected date or time value.
5. Press the **CLOCK** button to exit and save your settings.

Note: *If you do not press the **CLOCK** button within 30 seconds of changing a date or time value, the display will exit and save the new values automatically.*

Note: *Press and hold the **CLOCK** button for more than two seconds to automatically select the hour value for winter or summer time adjustment.*

12/24 hour format

1. Press the **MENU** button repeatedly until the 12/24 icon is shown in the display.
2. Using the seek up or seek down button select your required setting.
3. Press the **MENU** button repeatedly or allow the system to time out to confirm your selection.

Sony and Sony DAB

Changing the date and time

1. Press the **CLOCK** button.
2. Press the left or right navigation button until the date or time value that you wish to change flashes in the display.
3. Using the up or down navigation button change the selected date or time value.
4. Using the left and right navigation buttons select additional date or time values that you wish to change. The selected value will flash in the display.
5. Repeat steps three and four as necessary.
6. Press the **CLOCK** button or the button between the navigation buttons to exit and save your settings.

12/24 hour format

1. Press the **MENU** button.
2. Press the up or down navigation button until the 12/24 icon is shown in the display.
3. Using the left or right navigation button select the required setting.
4. Press the **MENU** button or the button between the navigation buttons to confirm your selection.

Audio unit operation

ON/OFF CONTROL

Press the on/off control. This will also operate the unit for up to one hour with the ignition turned off.

The radio will switch off automatically after one hour.

BASS/TREBLE CONTROL

The bass function is used to adjust the low-frequency response of the audio unit.

The middle function is used to adjust the mid-frequency response of the audio unit.

The treble function is used to adjust the high-frequency response of the audio unit.

6000CD

Note: *The selected level will be shown in the display.*

1. Press the **SOUND** button once for bass, twice for middle or three times for treble.
2. Use the volume control or on some units the seek up or seek down button to make the necessary adjustment.

Sony and Sony DAB

Note: *You can adjust these settings separately for CD, Radio and Aux.*

Note: *The selected level will be shown in the display.*

1. Press the **TONE** button once for bass, twice for middle or three times for treble.
2. Use the up and down navigation buttons to make the necessary adjustment.

BALANCE/FADE CONTROL

The balance function is used to adjust the sound distribution between the left and right speakers.

The fade function is used to adjust the sound distribution from front to rear in vehicles fitted with rear speakers.

6000CD

Press the **SOUND** button four times for balance or five times for fade.

Use the volume control or on some units the seek up or seek down button to make the necessary adjustment.

Sony and Sony DAB

Press the **FAD/BAL** button once for fade or twice for balance.

Use the up and down navigation buttons for fade adjustment, and the left and right navigation buttons for balance adjustment.

The selected level will be shown in the display.

AUDIO MENU CONTROL

Use the **MENU** button to access functions that cannot be selected directly via one of the control buttons. Press the **MENU** button for first level functions, or press and hold the **MENU** button for other second level functions (not available on Sony or Sony DAB audio units).

Audio unit operation

6000CD

Menu functions			
First level			Second level
During radio reception	During tape playback	During CD playback	During all functions
Manual tuning	12/24 hour	Scan	Traffic local or distant
Scan tuning	AVC*	Shuffle	AF**
12/24 hour	ADV menu	Repeat	REG
AVC*	-	Comp	News
ADV menu	-	12/24 hour	CLIP
-	-	AVC*	VID
-	-	ADV menu	Bluetooth enable/disable

Note: The sequence in which functions appear may vary for different audio units and vehicles.

Note: Second level functions (advanced) can also be entered by selecting ADV menu from the first level menu.

*Automatic volume control.

** Alternative frequencies.

Sony CD and Sony CD DAB

Menu functions	
During radio reception	During CD playback
12/24 hour	12/24 hour
CLIP ON/OFF	CLIP ON/OFF
News ON/OFF	News ON/OFF
AVC ¹	AVC ¹
AF ²	AF ²

Audio unit operation

Menu functions	
During radio reception	During CD playback
TA ³ volume	TA ³ volume
Traffic local or distant	Traffic local or distant
Regional ON/OFF	Shuffle
-	Repeat
-	Comp ON/OFF

Note: The sequence in which functions appear may vary for different audio units and vehicles.

¹Automatic volume control.

²Alternative frequencies.

³Traffic announcement.

Sony CD and Sony CD DAB with Bluetooth

Pressing **PHONE** followed by the **MENU** button will access the following options:

- No active phone or Active phone
- Debond BT device
- Reject calls ON/OFF
- Bluetooth ON/OFF.

STATION PRESET BUTTONS

This feature allows you to store your favourite stations so that they can be recalled by selecting the appropriate waveband and pressing one of the preset buttons.

1. Select a waveband.
2. Tune to the station required.
3. Press and hold one of the preset buttons. The audio unit will mute. When sound returns the station has been stored.

This can be repeated on each waveband and for each preset button.

Note: When you drive to another part of the country, FM RDS (Radio Data System) stations that broadcast on alternative frequencies are stored on the preset buttons.

WAVEBAND BUTTON

Note: The selector can also be used to return to radio reception when you have been listening to another source.

Press the **RADIO** button to select from the wavebands available.

AUTOSTORE CONTROL

Note: This function will overwrite the previously stored autostore preset stations.

Note: This function can also be used to store stations manually in the same way as other wavebands.

Note: The strongest signals available on the selected waveband will be stored.

Audio unit operation

The sound is muted and AUTOSTORE will be shown in the display while the unit searches through the frequencies.

When the search is complete, sound is restored and the strongest signals are stored on the autostore presets.

6000CD

Press and hold the **RADIO** button.

Sony CD

Press and hold the **AST** or **RADIO** button.

TRAFFIC INFORMATION CONTROL

Many stations that broadcast on the FM waveband have a TP code to signify that they carry traffic programme information.

Activating traffic announcements

Before you can receive traffic announcements, you must press the **TA** button. Either TA-D or TA-L will be shown in the display to indicate that the feature is switched on.

If you are already tuned to a station that broadcasts traffic information, TP will also be shown in the display. Otherwise the unit will search for a traffic programme and display TP SEEK while doing so. If it cannot locate such a station, NOT FOUND will be shown in the display.

TP will be shown within a box in the display when you are tuned to a station providing traffic information from a linked RDS (radio data system) or EON (enhanced other network) station.

When traffic information is broadcast, it will automatically interrupt normal radio, tape or CD playback and TRAFFIC or NEWS will be shown in the display.

If the traffic signal weakens, TP will flash in the display. Press the seek up or seek down button (the left or right navigation button on Sony or Sony DAB audio units) to find another station.

Note: *If this happens during CD or AUX playback or, on certain models, with the radio volume set to zero, the unit will retune automatically if the station is not available.*

If a non-traffic station is selected or recalled using a preset button, the audio unit will remain on that station unless **TA** is turned off, then on again.

Note: *If TA is on and you select a preset or manual tune set to a non TA station no traffic announcement will be heard.*

Local or distant traffic

The number of RDS or EON traffic announcements may become excessive in some areas so there is an option to select between local traffic information and all available information.

6000CD

1. Press and hold the **MENU** button until the display changes.
2. Press the **MENU** button repeatedly until TA is shown in the display.
3. Press the seek up or seek down button to select either local (TA LOCAL) or distant (TA DIST) traffic announcements.
4. Press the **MENU** button or allow the menu to time out to confirm your selection.

Note: *Either TA-L or TA-D will be shown in the display.*

Audio unit operation

Sony CD

1. Press the **MENU** button and use the up or down navigation button to select the TA display.
2. Press the left or right navigation button to select your required setting.
3. Press the **MENU** button to confirm your selection.

Traffic announcement volume

Traffic announcements interrupt normal broadcasts at a preset minimum level that is usually louder than normal listening volumes.

To adjust the preset volume

6000CD

1. Press and hold the **TA** button.
2. Rotate the volume control to make the necessary adjustment.

Note: *The selected level will be shown in the display.*

Sony CD

1. Press and hold the **TA** button.
2. Press the left or right navigation button to make the necessary adjustment.

Note: *The selected level will be shown in the display.*

Ending traffic announcements

The audio unit will return to normal operation at the end of each traffic announcement. To end the announcement prematurely, press **TA** during the announcement.

Note: *If you press TA at any other time it will switch all announcements off.*

STATION TUNING CONTROL

DAB service linking

Note: *The DAB service linking is as per default off.*

Note: *Service linking allows cross-referencing to other corresponding frequencies of the same station, for example FM and other DAB ensembles.*

Note: *The system will automatically change to another corresponding station if the current one becomes unavailable, for example when leaving the coverage area.*

Switching DAB service linking on and off

1. Press the **MENU** button.
2. Using the up or down navigation button scroll through the display until DIGITAL RADIO SERVICE LINK is shown in the display.
3. Using the left or right navigation button select AUTO or OFF.
4. Press the **MENU** button or the button between the navigation buttons to confirm your selection.

Seek tuning

6000CD

Select a waveband and briefly press the seek up or seek down button. The unit will stop at the first station it finds in the direction you have chosen.

Sony CD

Select a waveband and briefly press the up or down navigation button. The unit will stop at the first station it finds in the direction you have chosen.

Audio unit operation

Manual tuning

6000CD

1. Select a waveband and press the **MENU** button until MAN is shown in the display.
2. Press the seek up or seek down button to tune up or down the waveband in small increments or press and hold to increment quickly, until you find a station you want to listen to.

Sony CD

Select a waveband and briefly press the up or down navigation button to tune up or down the waveband in small increments. The display shows the frequency selected.

Sony DAB

Note: *Ensembles are groups of stations.*

Briefly press the up or down navigation button to move up or down the ensembles.

Scan tuning

The **SCAN** function allows you to listen to 10 seconds of each station detected.

6000CD

1. Press the **MENU** button repeatedly until SCAN is shown in the display.
2. Press the seek up or seek down button to scan up or down the selected waveband.
3. Depending on the audio unit, press the seek up or seek down button or the **MENU** button to continue listening to a station.

Sony and Sony DAB

1. Press the **SCAN** button. SCAN flashes or SCANNING is shown in the display.
2. Press the left or right navigation button to scan within a waveband.
3. Press **SCAN** again to continue listening to a station.

Audio unit menus

AUTOMATIC VOLUME CONTROL

When available, automatic volume control (AVC) adjusts the volume level to compensate for engine noise and road speed noise.

All except Sony and Sony DAB

1. Press the **MENU** button repeatedly until AVC is shown in the display.
2. Use the seek up or seek down button to adjust the AVC setting.
3. Press the **MENU** button or allow the system to time out to confirm your selection.

Sony and Sony DAB

1. Press the **MENU** button briefly.
2. Using the up or down navigation button select AVC.
3. Press the **MENU** button or allow the system to time out to confirm your selection.

DIGITAL SIGNAL PROCESSING (DSP)

DSP occupancy

This feature takes into account the differences in distance from the various speakers in the vehicle to each seat. Select the sitting position for which the audio is to be correctly enhanced.

DSP equaliser

Select the music category that most suits your listening preference. The audio output will change to enhance the particular style of music chosen.

Changing the DSP settings

1. Press the **DSP** button once for occupancy and twice for equaliser. For item location: See **Audio unit overview** (page 272).
2. Use the up and down navigation buttons to select the required setting.
3. Press the button between the navigation buttons to confirm your selection.

AUDIO DISTORTION REDUCTION (CLIP)

When available CLIP automatically detects sound distortion and reduces the volume level until the distortion has been eliminated. This means that whilst the display might change numerically when you raise the volume manually with the control, there may be no actual increase in sound.

All except Sony and Sony DAB

1. Press and hold the **MENU** button until the display changes.
2. Press the **MENU** button repeatedly until CLIP is shown in the display.
3. Using the seek up or seek down button turn the function on or off.
4. Press the **MENU** button or allow the system to time out to confirm your selection.

Sony and Sony DAB

1. Press the **MENU** button briefly.
2. Using the up or down navigation button select CLIP.
3. Press the **MENU** button or allow the system to time out to confirm your selection.

Audio unit menus

ALTERNATIVE FREQUENCIES

Many programmes broadcast on the FM waveband have a programme identification (PI) code, which can be recognised by audio units.

If your radio has alternative frequencies (AF) tuning switched on and you move from one transmission area to another, this function will search for and switch to a stronger station signal, if one can be found.

Under certain conditions, however, AF tuning may temporarily disrupt normal reception.

When selected, the unit continually evaluates signal strength and, if a better signal becomes available, the unit will switch to that alternative. It mutes while it checks a list of alternative frequencies and, if necessary, it will search once across the selected waveband for a genuine alternative frequency.

It will restore radio reception when it finds one or, if one is not found, the unit will return to the original stored frequency. On certain units, NOT FOUND will be shown in the display.

With AF-MAN selected, the unit operates in a similar way to AF-AUTO or AF-ON, but only searches for an alternative frequency when prompted by pressing a preset button.

With AF-OFF selected, the original stored frequency remains selected. In this mode, AF-OFF will be displayed every time the unit is turned on.

All except Sony and Sony DAB

1. Press and hold the **MENU** button until the display changes.
2. Press the **MENU** button repeatedly until AF is shown in the display.

3. Using the seek up or seek down button select the required setting.
4. Press the **MENU** button or allow the system to time out to confirm your selection.

Sony and Sony DAB

1. Press the **MENU** button briefly.
2. Using the left or right navigation button select the required setting.
3. Press the **MENU** button to confirm your selection.

REGIONAL MODE (REG)

Regional mode (REG) controls the behaviour of AF switching between regionally related networks of a parent broadcaster. A broadcaster may run a fairly large network across a large part of the country. At various times of the day this large network may be broken down into a number of smaller regional networks, typically centred on major towns or cities. When the network is not split into regional variants, the whole network carries the same programming.

Regional mode ON: This prevents 'random' AF switches when neighbouring regional networks are not carrying the same programming.

Regional mode OFF: This allows a larger coverage area if neighbouring regional networks are carrying the same programming, but can cause 'random' AF switches if they are not.

All except Sony and Sony DAB

1. Press and hold the **MENU** button until the display changes.
2. Press the **MENU** button repeatedly until REG is shown in the display.

Audio unit menus

3. Using the seek up or seek down button turn the function on or off.
4. Press the **MENU** button or allow the system to time out to confirm your selection.
3. Press the button between the navigation buttons to make your selection.
4. Using the left or right navigation button turn the function on or off.

Sony and Sony DAB

1. Press the **MENU** button briefly.
2. Using the up or down navigation button select REGIONAL.
3. Press the **MENU** button or allow the system to time out to confirm your selection.

5. Press the **MENU** button or the button between the navigation buttons to confirm your selection.

NEWS BROADCASTS

Some audio units interrupt normal reception to broadcast news bulletins from stations on the FM waveband or radio data system (RDS) and enhanced other network (EON) linked stations, in the same way as traffic information is provided.

During news broadcasts, the display alternates between the station name and NEWS. News interrupts are broadcast at the same preset volume level as traffic announcements.

All except Sony and Sony DAB

1. Press and hold the **MENU** button until NEWS is shown in the display.
2. Using the seek up or seek down button turn the function on or off.
3. Press the **MENU** button to confirm your selection.

Sony and Sony DAB

1. Press the **MENU** button.
2. Using the up or down navigation button scroll through the display until NEWS is shown in the display.

Compact Disc Player

LOADING COMPACT DISCS

6000CD, Sony and Sony DAB

Always check that the CD aperture is empty before inserting a CD.

Insert a CD, label side up, into the audio unit.

LOADING, READING CD and **AUDIO CD** or **MP3 CD** will be shown in the display, and playback will start automatically.

TRACK SELECTION

All except Sony and Sony DAB

1. Press the **SEEK UP** button once to move to the next track or press it repeatedly to access later tracks.
2. Press the **SEEK DOWN** button once to replay the current track. If pressed within two seconds of the start of a track, the previous track will be selected.
3. Press the **SEEK DOWN** button repeatedly to select previous tracks.

Sony and Sony DAB

1. Press the up navigation button once to move to the next track or press it repeatedly to access later tracks.
2. Press the down navigation button once to replay the current track. If pressed within two seconds of the start of a track, the previous track will be selected.
3. Press the down navigation button repeatedly to select previous tracks.

LOADING THE COMPACT DISC CHANGER

CAUTIONS

- ⚠ Do not insert more than one disc into each slot.
- ⚠ Keep the door closed when the magazine is installed.

Note: *The unit will only accept conventional CD's.*

For item location: See **CD changer** (page 142).

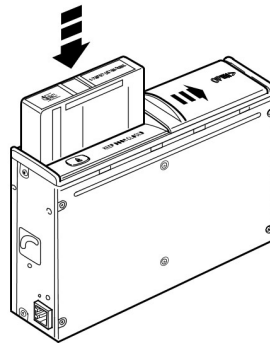

1. Open the door.
2. Press the button.
3. Remove the magazine.
4. Insert a disc, with the label facing upwards, into each slot. You will hear a distinct click to confirm correct loading.
5. Install the magazine in the direction indicated by the arrow on the magazine. You will hear a distinct click to confirm correct loading.
6. Close the door.

Compact Disc Player

UNLOADING THE COMPACT DISC CHANGER

CAUTION

 Keep the door closed when the magazine is installed.

1. Open the door.
2. Press the button.
3. Remove the magazine.
4. Pull the tray out using the lever on the side.
5. Remove the CD and close the tray.
6. Repeat steps four and five to remove remaining CD's.
7. Install the magazine in the direction indicated by the arrow on the magazine. You will hear a distinct click to confirm correct loading.
8. Close the door.

COMPACT DISC PLAYBACK

Note: During playback, the display indicates the disc, track and time that has elapsed since the start of the track.

Note: On CD changer audio units, if two or more CD's are loaded one after the other, playback will start with the last CD loaded.

During radio reception, press the **CD/AUX** button once to start CD playback.

Playback will start immediately after a disc is loaded.

Compact disc changer playback

Press the **CD/AUX** button twice to start CD playback.

Note: If the **CD/AUX** button is pressed when no discs are loaded, NO CDS will be shown in the display.

FAST FORWARD/REVERSE

All except Sony and Sony DAB

Press and hold the seek up or the seek down button to search forwards or backwards within the tracks on the disc.

Sony and Sony DAB

Press and hold the left or right navigation button to search forwards or backwards within the tracks on the disc.

SHUFFLE/RANDOM

Random track playback, also known as shuffle, plays all tracks on a CD in random order.

6000CD

Note: When *SHUFF CD* is selected only the tracks on the current CD will be shuffled. When *SHUF ALL* is selected the tracks on all the CD's will be shuffled.

1. Press the **MENU** button repeatedly until SHUF is shown in the display.
2. Using the seek up or seek down button scroll through the display until SHUF ALL or SHUFF CD is shown in the display.
3. Using the seek up or seek down button select the next track to shuffle if required.

Note: With the function on, *SHUFFLE* will be shown in the display as each new track is selected.

Compact Disc Player

Sony CD and Sony CD DAB

1. Press the **MENU** button.
2. Using the up or down navigation button scroll through the display until SHUFFLE is shown in the display.
3. Use the left or right navigation button to switch the function on and off.

Note: When an MP3 CD is playing, options include SHUFF CD for the whole CD, or SHUF ALL to play all the tracks in the folder in a random order.

COMPACT DISC TRACK COMPRESSION

With this feature on, quieter music is boosted and louder music lowered to minimise repeated volume adjustments.

All except Sony and Sony DAB

1. Press **MENU** repeatedly until COMP is shown in the display.
2. Using the seek up or seek down button turn the function on or off.
3. Press the **MENU** button to confirm your selection.

Sony and Sony DAB

1. Press the **MENU** button.
2. Using the up or down navigation button scroll through the display until COMP is shown in the display.
3. Press the button between the navigation buttons to make your selection.
4. Using the left or right navigation button turn the function on or off.
5. Press the **MENU** button or the button between the navigation buttons to confirm your selection.

COMPACT DISC TRACK SCANNING

The SCAN function allows you to preview each track for approximately 10 seconds.

6000CD

Note: When selected, **SCAN** will be shown briefly in the display at the start of each track.

1. Press the **MENU** button repeatedly until **SCAN** is shown in the display.
2. Using the seek up or seek down button select either **SCAN CD** or **SCAN ALL**.
3. Press the seek up or seek down button again to continue listening to a track.

Sony and Sony DAB

Note: Various scan modes are possible, according to the type of CD currently playing.

1. Press the **SCAN** button once to scan each track on an audio CD, or the first 10 seconds of each track on each folder of a MP3 CD.
2. Press the **SCAN** button again to select **SCAN OFF** (audio CD), or in the case of MP3 to scan each track within a folder.

EJECTING COMPACT DISCS

Note: Radio reception is restored automatically when the **EJECT** button is pressed.

Note: If the **EJECT** button is pressed in error, press the button again to cancel.

Note: If the CD is not removed it will be pulled back into the audio unit.

Compact Disc Player

6000CD

Press the **EJECT** button at any time and remove the CD.

Sony CD

Note: If no CD is loaded when the **EJECT** button is pressed, **NO CD** will be shown in the display.

Press the **EJECT** button at any time and remove the CD. **EJECTING** and **PLEASE REMOVE** will be shown in the display.

REPEAT COMPACT DISC TRACKS

6000CD

1. Press the **MENU** button repeatedly until **REPEAT** is shown in the display.
2. Using the **SEEK UP** or **SEEK DOWN** button choose between **OFF** and **TRK.**

Sony and Sony DAB

1. Press the **MENU** button.
2. using the up or down navigation buttons scroll through the display until **REPEAT** is shown in the display.
3. Using the left or right navigation buttons select **REPEAT TRACK** or **REPEAT OFF.**
4. Press the **MENU** button to confirm your selection.

Note: When an MP3 CD is playing, playback options are **REPEAT TRACK**, **REP FOLDER** and **REPEAT OFF.**

MP3 FILE PLAYBACK

Note: Some copy protected audio files may not be read by the CD player.

The CD player also supports MP3 and WMA format audio files.

When a CD containing audio is inserted into the CD player the disc's directory structure is read in. It may take a while before playback starts and is dependant on the quality of the disc.

MP3 tracks may be recorded on the CD in several ways. They can all be placed in the root directory like a conventional audio CD, or they can be placed in folders that may represent, for example, an album, an artist, or a genre.

6000CD

Press the **FOLDER UP** button to select the next music folder on the MP3 disc.

Press the **FOLDER DOWN** button to select the previous music folder on the MP3 disc.

Sony and Sony DAB

Use the up and down navigation buttons to select the next or previous music folder on the MP3 disc.

Playing a multi session disc

The normal playing sequence on CD's with multiple folders is to play the tracks in the first folder, then the tracks in any folders nested inside the first folder, then move onto the second folder, and so on. For example, if folder 1 has folders 1a and 1b within it, and folder 2 contains folder 2a, the playing sequence will be folder 1, 1a, 1b, 2, 2a.

When the playback of a file is finished the playback of the other files in the same directory continues. Directory change takes place automatically when all files in the current directory have been played back.

Compact Disc Player

MP3 DISPLAY OPTIONS

When an MP3 disc is playing, certain information encoded in each track can be displayed. Such information will normally include:

- The file name
- The folder name
- ID3 information which might be the album or artist's name.

The unit will normally show the file name that is playing. To select one of the other items of information, press the **INFO** button repeatedly until the required item is shown in the display.

Note: *If the ID3 information selected is unavailable, **NO MP3 TAG** will be shown in the display.*

CD text display options

When an audio disc with CD text is playing, limited information encoded in each track can be displayed. Such information will normally include:

- The disc name
- The artist name
- The track name.

Note: *These display options are selected in the same way as MP3 displays. **NO DISC NAME** or **NO TRACK NAME** will be shown in the display if no information has been encoded.*

ENDING COMPACT DISC PLAYBACK

Press the **RADIO** button.

Note: *This will not eject the CD; the disc will merely pause at the point where radio reception was restored.*

To resume CD playback, press the **CD/AUX** button again.

Auxiliary input (AUX IN) socket

Note: *For optimum performance when using any auxiliary device set the volume on the device high. This will reduce audio interference when charging the device via the vehicle power supply socket.*

When fitted the Auxiliary input (AUX IN) socket permits an auxiliary device, such as an MP3 player, to be linked into the vehicle audio system. Output can be played through the vehicle speakers.

To connect an auxiliary device, plug it into the AUX IN socket using a 3.5 mm conventional audio jack connector.

Select the auxiliary input via the **CD/AUX** button and playback will be heard through the vehicle speakers. AUX will be shown in the display. Volume, treble and bass can be adjusted on the audio unit as normal.

The audio unit buttons can also be used to restore playback from the audio unit, while the auxiliary device remains connected.

Audio Troubleshooting

AUDIO TROUBLESHOOTING

Audio unit display	Rectification
CD ERROR PLEASE CHECK CD CDC ERROR	General error message for CD fault conditions, for example cannot read the CD, data-CD inserted. May also indicate a audio unit malfunction. Make sure that the disc is correctly loaded, clean and re- load the CD or replace the CD with a known music CD. See Ejecting compact discs (page 288). See Loading compact discs (page 286). If error continues. See your dealer.
NO CD NO CDS NO CD #	Message to indicate that the audio unit or CD changer is empty. Insert a CD. See Loading compact discs (page 286).
HIGH TEMP CD DRIVE HIGH TEMP	Ambient temperature too hot – unit will not work until it has cooled down.
SLOT FULL	Message to indicate that the CD slot is already loaded. Eject the CD from selected slot before attempting load operation or select another slot location. See Loading compact discs (page 286).
CDC FULL	Message to indicate that the audio unit is full. See Ejecting compact discs (page 288).
DATA CD	An incompatible CD has been inserted, for example not an audio CD. See Ejecting compact discs (page 288).
CODE ----	Message to prompt you for the Keycode. See Entering a security code (page 275).
WAIT	Message to inform you to wait until the next keycode entry attempt can be made. See Incorrect security code (page 275).
TRIES	Message indicates the number of incorrect input attempts. See Incorrect security code (page 275).
LOCKED	Message to inform you that audio unit security system has locked the unit after repeated incorrect keycode entries. See your dealer.
KEYCODE.... ENTER KEYCODE....	Message to prompt you for the Keycode. See Entering a security code (page 275).
INCORRECT	Message to inform you that the entered keycode is incorrect. See Incorrect security code (page 275).

Telephone

GENERAL INFORMATION

CAUTION

-  Using the system with the engine off will drain the battery.

This section describes the functions and features of the Bluetooth mobile phone hands free system.

The Bluetooth mobile phone part of the system provides interaction with the audio or navigation system and your mobile phone. It allows you to use the audio or navigation system to make and receive calls without having to hold your mobile phone.

Compatibility of phones

CAUTION

-  As no common agreement exists, mobile phone manufacturers are able to implement a variety of profiles in their Bluetooth devices. Because of this, an incompatibility can occur between the phone and hands-free system, which in some cases may significantly degrade the system performance. To avoid this situation, only recommended phones should be used.

Please visit the website **www.ford-mobile-connectivity.com** for full details.

BLUETOOTH SETUP

Before you can use your telephone with your vehicle it must be bonded to the vehicle telephone system.

Handling of phones

Up to six Bluetooth devices can be bonded to the vehicle system.

Note: *If there is an ongoing call when the phone in use is selected as the new active phone, the call is transferred to the vehicle audio system.*

Note: *Even if connected to the car system, your phone can still be used in the usual way.*

Requirements for Bluetooth connection

The following are required before a Bluetooth phone connection can be made.

1. The Bluetooth feature must be activated on the phone and on the audio unit. Make sure the Bluetooth menu option in the audio unit is set to **ON**. For information on phone settings, refer to your phone user guide.
2. In the Bluetooth menu on your phone, search for **Ford Audio** and select it.
3. Enter the code number shown on the vehicle display using the phone keypad. If no code number is shown on the display, enter the Bluetooth PIN number 0000 using the phone keypad. Now enter the Bluetooth PIN number shown on the vehicle display.
4. If your mobile phone asks you to authorize the automatic connection, select **YES**.

Note: *A phone call will be disconnected if the audio unit is switched off. If the ignition key is turned to the off position the phone call will remain in progress.*

TELEPHONE SETUP

Phonebook

After start up access to the phonebook list can be delayed for several minutes, depending upon the size.

Telephone

Phonebook categories

Depending on your phonebook entry, different categories can be displayed in the audio unit.

For example:

M	Mobile
O	Office
H	Home
F	Fax

Note: Entries may be displayed without a category attachment.

The category can also be indicated as an icon:



Making a phone an active phone

When using the system for the first time, no phone is connected to the system.

Bluetooth phone

After bonding a Bluetooth phone to the system, this becomes the active phone. For further information refer to the phone menu.

Select the phone from the active phone menu.

Turning the ignition and radio or navigation unit back on again, the last active phone is picked up by the system.

Note: In some cases the Bluetooth connection must also be confirmed on the phone.

Bond another Bluetooth phone

Bond a new Bluetooth phone as described in the requirements for a Bluetooth connection.

Phones stored in the system are accessible by using the phone list on the audio unit.

Note: A maximum of six devices may be bonded. If six Bluetooth devices have already been bonded, one of these has to be debonded in order to bond a new device.

TELEPHONE CONTROLS

Remote control

Voice, accept and reject button



E87662

- 1 Voice button
- 2 Accept and reject button

The VOICE button is used to activate or switch off the Voice control.

On vehicles with an accept and reject button, phone calls can be accepted and rejected by pressing the appropriate button.

Telephone

Note: Some audio units have the accept and reject buttons on the front bezel. These operate in the same way.

USING THE TELEPHONE - VEHICLES WITHOUT: NAVIGATION SYSTEM

This chapter describes the phone functions of the audio unit.

Note: Refer to your audio guide for details of the controls.

An active phone must be present.

Even if connected to the audio unit, your phone can still be used in the usual way.

Note: You can exit the phone menu by pressing any source button **CD**, **AM/FM** or **AUX**.

Making a call

Dialling a number using voice control

Phone numbers can be dialled using voice control. See **Telephone commands** (page 310).

Dialling a number using the address book

You can access your phone address book via Bluetooth. The entries will appear in the unit display.

1. Press the **PHONE** or the call accept button.
2. Press the **MENU** button.
3. Keep pressing the **MENU** button until **PHONEBOOK** appears.
4. Press the seek buttons to select the desired phone number.

Note: Press and hold the seek button to skip to the next letter in the alphabet.

5. Press the **PHONE** or the call accept button to dial the selected phone number.

Dialling a number using the address book - Sony radio

You can access your phone address book via Bluetooth. The entries will appear in the unit display.

1. Press the **PHONE** button.
2. Press the seek button until the phone book is shown.
3. Press the up/down arrow buttons to select the desired phone number.

Note: Press and hold the up/down arrow buttons to skip to the next letter in the alphabet.

4. Press the **PHONE** or the call accept button to dial the selected phone number.

Dialling a number using the telephone keypad

If you have an audio unit with a telephone keypad (buttons 0-9, * and #):

1. Press the call accept button. Press the **PHONE** button if you have a Sony radio.
2. Dial the number using the telephone keypad on the audio unit.
3. Press the call accept button.

Note: If you enter an incorrect digit whilst entering a phone number, press the seek left button to erase the last digit. A long press will erase the complete string of digits.

Press and hold **0** to enter a **+** digit.

Ending a call

Calls can be ended by pressing the call reject button.

Telephone

Audio units without a telephone keypad can also end a call by pressing either **PHONE**, **CD**, **AM/FM** or **ON/OFF**, or by pressing the **MODE** button on the remote control

Redialling a number

1. Press the **PHONE** or the call accept button.
2. Press the **MENU** button.
3. Select the **CALL OUT** list or the **CALL IN** list. On some audio units, select the **MISSED**, **INCOMING** or **OUTGOING** calls list.

Note: *If the active phone does not provide a call out list, the last outgoing call number/entry can be redialled.*

4. Press the seek button on the audio unit.
5. Press the **PHONE** or the call accept button to dial the desired phone number.

Redialling a number - Sony radio

1. Press the **PHONE** or the call accept button.
2. Press the seek button until the desired list is displayed.

Note: *If the active phone does not provide a call out list, the last outgoing call number/entry can be redialled.*

3. Press the up/down buttons to select the desired phone number.
4. Press the **PHONE** or the call accept button to dial the phone number.

Redialling the last dialled number - Sony radio

1. Press the call accept button.
2. Press the call accept button a second time to dial the number.

Receiving an incoming call

Accepting an incoming call

Incoming calls can be accepted by pressing either the call accept button, the **PHONE** button or the **MODE** button on the remote control.

Rejecting an incoming call

Incoming calls can be rejected by pressing the call reject button.

Audio units without a telephone keypad can also reject a call by pressing either **PHONE**, **CD**, **AM/FM** or **ON/OFF**.

Receiving a second incoming call

Note: *The second incoming call function must be activated in your phone.*

If there is an incoming call whilst there is an ongoing call, a beep will be heard and you will have the option to end the active call and to accept the incoming call.

Accepting a second incoming call

Second incoming calls can be accepted by pressing either the call accept button, the **PHONE** button, or the **MODE** button on the remote control.

Rejecting a second incoming call

Second incoming calls can be rejected by pressing the call reject button. Units without a telephone keypad can also reject a second incoming call by pressing the **CD** button, or the **AM/FM** button.

Muting the microphone

During a call, it is possible to mute the microphone. Whilst muted, confirmation will appear in the display.

Telephone

Audio units with green call accept button

Press the call accept button. Press the button once again to turn this function off.

Audio units without green call accept button

Press the seek up or down button. Press the button once again to turn this function off.

Changing the active phone

Note: *Phones must be bonded to the system before they can be made active.*

Using the station storage button

Note: *This process is only for audio units without a telephone keypad.*

1. Press the **PHONE** button on the audio unit.
2. Press the preset number required (using the station preset buttons 1 - 6).

Using the audio unit menu

Note: *After bonding a phone to the system, this becomes the active phone.*

1. Press the **PHONE** or call accept button.
2. Press the **MENU** button on the audio unit.
3. Select the **ACTIVE PHONE** option on the audio unit.
4. Scroll through the different stored phones by using the seek buttons to display the bonded phones.
5. Press the **MENU** button to select the phone which is to be the active phone.

Debonding a bonded phone

A bonded phone can be deleted from the system at any time, unless a phone call is in progress.

1. Press the **PHONE** or call accept button.
2. Press the **MENU** button on the audio unit.
3. Select the **DEBOND** option on the audio unit.
4. Scroll through the different phones by using the seek buttons and display the phone to be debonded.
5. Press the **MENU** button to select the phone which is to be debonded.

Debonding a bonded phone - Sony radio

A bonded phone can be deleted from the system at any time, unless a phone call is in progress.

1. Press the **PHONE** button.
2. Press the up/down arrow buttons until you reach the **DEBOND** option.
3. Scroll through the different phones by using the seek buttons and display the phone to be debonded.
4. Press the OK button to be debond.

USING THE TELEPHONE - VEHICLES WITH: NAVIGATION SYSTEM

This chapter describes the phone functions of the Navigation System.

Note: *Refer to your Navigation System guide for details of the controls.*

An active phone must be present.

Even if connected to the Navigation System, your phone can still be used in the usual way.

Telephone

Making a call

Dialling a number

Phone numbers can be dialled using voice control. See **Voice control** (page 300).

Ending a call

Calls can be ended by pressing either the **END** button, the **MODE** button on the remote switch or the **ON/OFF** button on the navigation system.

Redialling a number

1. Press the **PHONE** button on the unit.
2. Select **REDIAL**.

Receiving an incoming call

Accepting an incoming call

Incoming calls can be accepted by pressing either the call accept button, the **MODE** button on the remote control, the **PHONE** button on the unit or by using the **ACCEPT** option in the menu.

Rejecting an incoming call

Incoming calls can be rejected by pressing either the call reject button, the **CD** or **AM/FM** buttons on the unit, or by using the **REJECT** option in the menu.

Receiving a second incoming call

Note: *The second incoming call function must be activated in your phone.*

If there is an incoming call, whilst there is an ongoing call, a beep will be heard and you will have the option to end the active call and to accept the incoming call.

Accepting a second incoming call

Second incoming calls can be accepted by pressing either the call accept button, the **MODE** button on the remote control, the **PHONE** button on the unit or by using the **ACCEPT** option in the menu.

Note: *This will cancel the ongoing call.*

Rejecting a second incoming call

Second incoming calls can be rejected by pressing either the call reject button, or one of the following buttons on the unit: **CD**, **AM/FM**.

Muting the microphone

During a call, it is possible to mute the microphone. Whilst muted, confirmation will appear in the display.

SD navigation units

Press the mute button (symbol of a microphone with a line through it). Press the button once again to turn this function off.

CD navigation units

Press the microphone mute button. Press the button once again to turn this function off.

Changing the active phone

Note: *Phones must be bonded to the system before they can be made active.*

Note: *After bonding a phone to the system, this becomes the active phone.*

1. Press the **PHONE** button on the unit.
2. Using the **BT SETTINGS** option in the menu, select the active phone from the list.

Telephone

Debonding a bonded phone

A bonded phone can be deleted from the system at any time, unless a phone call is in progress.

1. Press the **PHONE** button on the unit.
2. Select the **BT SETTINGS** option in the menu.
3. Select the **DEBOND** option in the menu.
4. Select the phone from the list.

Voice control

PRINCIPLE OF OPERATION

CAUTION

 Using the system with the engine off will drain the battery.

Voice recognition enables operation of the system without the need to divert your attention from the road ahead in order to change settings, or receive feedback from the system.

Whenever you issue one of the defined commands with the system active, the voice recognition system converts your command into a control signal for the system. Your inputs take the form of dialogues or commands. You are guided through these dialogues by announcements or questions.

Please familiarise yourself with the functions of the system before using voice recognition.

Supported commands

The voice control system allows you to control the following vehicle functions:

- Bluetooth phone
- radio
- CD Player/CD Changer
- external device (USB)
- external device (iPod)
- automatic climate control
- navigation system - refer to separate navigation handbook).

System response

As you work through a voice session the system will prompt you with a beep tone each time the system is ready to proceed.

Do not try to give any commands until the beep tone has been heard. The voice control system will repeat each spoken command back to you.

If you are not sure how to continue say "HELP" for assistance or "CANCEL" if you do not wish to continue.

The "HELP" function provides only a subset of the available voice commands. Detailed explanations of all possible voice commands can be found on the following pages.

Voice commands

All voice commands should be given using a natural speaking voice, as if speaking to a passenger or on the phone. Your voice level should be dependant on the surrounding noise level inside or outside the vehicle but do not shout.

USING VOICE CONTROL

System operation

The order and content of the voice controls are given in the following lists. The tables show the sequence of user voice commands and system responses for each available function.

<> indicates a number or stored name tag to be inserted by the user.

Short cuts

There are a number of voice command short cuts available, which allow you to control some vehicle features without having to follow the complete command menu. These are:

- Phone: CALL or DIAL NAME, DIAL NUMBER, and REDIAL.
- Phone: CALL FIRST NAME, LAST NAME at LOCATION. Example: Call Fred Bloggs at home.

Voice control

- CD player or CD changer: DISC and TRACK.
- Automatic climate control: TEMPERATURE, AUTO MODE, DEFROSTING ON, DEMISTING ON, DEFROSTING OFF and DEMISTING OFF.
- Radio: TUNE NAME.
- External device (USB, iPod and SD card): TRACK.

Start communicating with the system

Before you can start talking to the system you first have to press the **VOICE** or **MODE** button for each operation and wait until the system answers with a beep. See (page 300).

Press the button again to cancel the voice session.

Name tag

The name tag functionality can support the phone, audio and navigation features by using the "STORE NAME" function. You can assign name tags to items such as favourite radio stations and personal phone contacts. See **Audio unit commands** (page 301). See **Telephone commands** (page 310). See **Navigation system commands** (page 315).

- Store up to 20 name tags per function.
- The average recording time for each name tag is approximately 2-3 seconds.

AUDIO UNIT COMMANDS

CD Player

You can control playback directly by voice control.

Overview

The overview below shows the available voice commands. The following lists will give further information about the complete command menu in selected examples.

"CD PLAYER"
"HELP"
"PLAY"
"TRACK"
"SHUFFLE ALL"
"SHUFFLE FOLDER"
"SHUFFLE OFF"
"REPEAT FOLDER"

Voice control

"CD PLAYER"
"REPEAT TRACK"
"REPEAT OFF"

* Can be used as a shortcut.

** Only available if the CD contains audio data files like MP3 or WMA.

Track

You can choose a track on your CD directly.

Steps	User says	System answer
1	"CD PLAYER"	"CD PLAYER"
2	"TRACK"	"TRACK NUMBER PLEASE"
3	"<a number between 1 and 99>"**	"TRACK <number>"

* Can be used as a shortcut.

** Additionally, numbers can be spoken as up to four single digits (for example "2", "4", "5" for track 245)

Shuffle all

To set random playback.

Steps	User says	System answer
1	"CD PLAYER"	"CD PLAYER"
2	"SHUFFLE ALL"	

CD Changer

Overview

The overview below shows the available voice commands. The following lists will give further information about the complete command menu in selected examples.

Voice control

"CD CHANGER"
"HELP"
"PLAY"
"DISC"
"TRACK"
"SHUFFLE ALL"
"SHUFFLE CD"
"SHUFFLE FOLDER"
"SHUFFLE OFF"
"REPEAT CD"
"REPEAT FOLDER"
"REPEAT TRACK"
"REPEAT OFF"

* Can be used as a shortcut.

** Only available if the CD contains audio data files like MP3 or WMA.

Disc

If you have a CD changer you can choose the disc number.

Steps	User says	System answer
1	"CD CHANGER"	"CD CHANGER"
2	"DISC"	"DISC NUMBER PLEASE"
3	"<a number between 1 and 6>"	"DISC <number>"

* Can be used as a shortcut.

Track

You can choose a track on your CD directly.

Voice control

Steps	User says	System answer
1	"CD CHANGER"	"CD CHANGER"
2	"TRACK"	"TRACK NUMBER PLEASE"
3	"<a number between 1 and 99>"**	"TRACK <number>"

* Can be used as a shortcut.

** Additionally, numbers can be spoken as up to four single digits (for example "2", "4", "5" for track 245)

Shuffle CD

To set random playback within the CD contents.

Steps	User says	System answer
1	"CD CHANGER"	"CD CHANGER"
2	"SHUFFLE CD"	

Radio

The radio voice commands support the functionality of the radio and allow you to tune radio stations by voice control.

Overview

The overview below shows the available voice commands. The following lists will give further information about the complete command menu.

"RADIO"
"HELP"
"AM"
"FM"
"TUNE NAME"
"DELETE NAME"
"DELETE DIRECTORY"
"PLAY DIRECTORY"

Voice control

"RADIO"
"STORE NAME"
"PLAY"

* Can be used as a shortcut.

Tune frequency

This function allows you to tune your radio by voice commands.

Steps	User says	System answer
1	"RADIO"	"RADIO"
2	"AM"	"AM FREQUENCY PLEASE"
	"FM"	"FM FREQUENCY PLEASE"
3	"<frequency>"*	"TUNE <frequency>"

* The frequency may be entered in a variety of ways. Refer below for representative examples.

FM band: 87.5 - 108.0 in increments of 0.1

- "Eighty nine point nine" (89.9)
- "Ninety" (90.0)
- "One hundred point five" (100.5)
- "One zero one point one" (101.1)
- "One zero eight" (108.0)

- "Five thirty one" (531)
- "Nine hundred" (900)
- "Fourteen forty" (1440)
- "Fifteen zero three" (1503)
- "Ten eighty" (1080)

Store name

AM/MW band: 531 - 1602 in increments of 9

If you have tuned a radio station, you can store it with a name in the directory.

AM/LW band: 153 - 281 in increments of 1

Steps	User says	System answer
1	"RADIO"	"RADIO"
2	"STORE NAME"	"STORE NAME" "NAME PLEASE"
3	"<name>"	"REPEAT NAME PLEASE"
4	"<name>"	"STORING NAME"

Voice control

Steps	User says	System answer
		"<name> STORED"

Tune name

This function allows you to call up a stored radio station.

Steps	User says	System answer
1	"RADIO"	"RADIO"
2	"TUNE NAME"*	"NAME PLEASE"
3	"<name>"	"TUNE <name>"

* Can be used as a shortcut.

Delete name

This function allows you to delete a stored radio station.

Steps	User says	System answer
1	"RADIO"	"RADIO"
2	"DELETE NAME"	"NAME PLEASE"
3	"<name>"	"DELETE <name>" "CONFIRM YES OR NO"
4	"YES"	"DELETED"
	"NO"	"COMMAND CANCELLED"

Play directory

This function allows you to let the system tell you all of the stored radio stations.

Steps	User says	System answer
1	"RADIO"	"RADIO"
2	"PLAY DIRECTORY"	"PLAY <DIRECTORY>"

Voice control

Delete directory

This function allows you to delete all stored radio stations at once.

Steps	User says	System answer
1	"RADIO"	"RADIO"
2	"DELETE DIRECTORY"	"DELETE DIRECTORY" "CONFIRM YES OR NO"
3	"YES"	"RADIO DIRECTORY DELETED"
	"NO"	"COMMAND CANCELLED"

Play

This function switches the audio source to the radio mode.

Steps	User says	System answer
1	"RADIO"	"RADIO"
2	"PLAY"	

Auxiliary input

This function allows you to switch the audio source to the attached auxiliary input device.

Steps	User says	System answer
1	"EXTERNAL DEVICE"	"EXTERNAL DEVICE"
2	"LINE IN"	"LINE IN"

External devices - USB

These voice commands support the functionality of an external USB device which may be connected to the audio unit.

Overview

The overview below shows the available voice commands. The following lists will give further information about the complete command menu in selected examples.

Voice control

"EXTERNAL DEVICE", "USB"
"HELP"
"PLAY"
"TRACK"
"PLAYLIST"
"FOLDER"
"SHUFFLE ALL"
"SHUFFLE FOLDER"
"SHUFFLE PLAYLIST"
"SHUFFLE OFF"
"REPEAT TRACK"
"REPEAT FOLDER"
"REPEAT OFF"

* Can be used as a shortcut.

** Playlists and folders activated by voice control must be assigned special filenames. See **General Information** (page 318).

USB play

This function allows you to switch the audio source to the attached USB device.

Steps	User says	System answer
1	"EXTERNAL DEVICE"	"EXTERNAL DEVICE"
2	"USB"	"USB"
3	"PLAY"	

USB Track

You can choose a track on your USB device directly.

Voice control

Steps	User says	System answer
1	"EXTERNAL DEVICE"	"EXTERNAL DEVICE"
2	"USB"	"USB"
3	"TRACK"	"TRACK NUMBER PLEASE"
4	"<a number between 1 and 99>"*	"TRACK <number>"

* Additionally, numbers can be spoken as up to four single digits (for example "2", "4", "5" for track 245)

External devices - iPod

These voice commands support the functionality of an iPod which may be connected to the audio unit.

Overview

The overview below shows the available voice commands. The following lists will give further information about the complete command menu in selected examples.

"EXTERNAL DEVICE", "IPOD"
"HELP"
"PLAY"
"TRACK"*
"PLAYLIST"**
"SHUFFLE ALL"
"SHUFFLE PLAYLIST"
"SHUFFLE OFF"
"REPEAT TRACK"
"REPEAT OFF"

* Can be used as a shortcut.

** Playlists activated by voice control must be assigned special filenames. See **General Information** (page 318).

iPod Track

You can choose a track off the all titles list of your iPod directly.

Voice control

Steps	User says	System answer
1	"EXTERNAL DEVICE"	"EXTERNAL DEVICE"
2	"IPOD"	"IPOD"
3	"TRACK"	"TRACK NUMBER PLEASE"
4	"<a number between 1 and 99>"**	"TRACK <number>"

* Can be used as a shortcut.

** Additionally, numbers can be spoken as up to five single digits (for example "5", "2", "4", "5", "3" for track 52453), to a limit of 65535.

iPod playlist

You can choose a playlist from your iPod directly.

Steps	User says	System answer
1	"EXTERNAL DEVICE"	"EXTERNAL DEVICE"
2	"IPOD"	"IPOD"
3	"PLAYLIST"	"PLAYLIST NUMBER PLEASE"
4	"<a number between 1 and 10>"	"PLAYLIST <number>"

* Playlists activated by voice control must be assigned special filenames. See **General Information** (page 318).

TELEPHONE COMMANDS

Phone

Your phone system allows you to create an additional phonebook. The stored entries can be dialled by voice control. Phone numbers stored by using voice control are stored on the vehicle system and not in your phone.

Overview

The overview below shows the available voice commands. The following lists will give further information about the complete command menu in selected examples.

Voice control

"PHONE"
"HELP"
"MOBILE NAME"*
"DIAL NUMBER"*
"DIAL NAME"*
"DELETE NAME"
"DELETE DIRECTORY"
"PLAY DIRECTORY"
"STORE NAME"
"REDIAL"*
"ACCEPT CALLS"
"REJECT CALLS"

* Can be used as a shortcut.

Phone functions

Dial number

Phone numbers can be dialled after giving the name tag voice command.

Steps	User says	System answer
1	"PHONE"	"PHONE"
2	"DIAL NUMBER"*	"NUMBER PLEASE"
3	"<phone number>"	"<phone number> CONTINUE?"
4	"DIAL"	"DIALLING"
	"CORRECTION"	"<repeat last part of number> CONTINUE?"

* Can be used as a shortcut.

Voice control

Dial name

Phone numbers can be dialled after giving the name tag voice command.

Steps	User says	System answer
1	"PHONE"	"PHONE"
2	"DIAL NAME"*	"NAME PLEASE"
3	"<name>"	"DIAL <name>" "CONFIRM YES OR NO"
4	"YES"	"DIALLING"
	"NO"	"COMMAND CANCELLED"

* Can be used as a shortcut.

Redial

This function allows you to redial the last dialled phone number.

Steps	User says	System answer
1	"PHONE"	"PHONE"
2	"REDIAL"	"REDIAL" "CONFIRM YES OR NO"
3	"YES"	"DIALLING"
	"NO"	"COMMAND CANCELLED"

* Can be used as a shortcut.

Mobile name

This function allows you to access phone numbers stored with a name tag in your mobile phone.

Steps	User says	System answer
1	"PHONE"	"PHONE"
2	"MOBILE NAME"*	"MOBILE NAME" "<phone dependent dialogue>"

* Can be used as a shortcut.

Voice control

DTMF (Tone dialling)

This function transfers spoken numbers into DTMF tones. For example, to make a remote enquiry to your home answering machine or to enter a PIN number etc.

Note: DTMF can only be used during an ongoing call. Operate the VOICE button and wait for the system prompt.

Can only be used with vehicles installed with a dedicated VOICE button.

Steps	User says	System answer
1		"NUMBER PLEASE"
2	"<numbers 1 to 9, zero, hash, star>"	

Create a phonebook

Store name

New entries can be stored with the "STORE NAME" command. This feature can be used to dial a number by calling up the name instead of the full phone number.

Steps	User says	System answer
1	"PHONE"	"PHONE"
2	"STORE NAME"	"STORE NAME" "NAME PLEASE"
3	"<name>"	"REPEAT NAME PLEASE"
4	"<name>"	"STORING NAME" "<name> STORED" "NUMBER PLEASE"
5	"<phone number>"	"<phone number>"
6	"STORE"	"STORING NUMBER" "<phone number>" "NUMBER STORED"

Delete name

Stored names can also be deleted from the directory.

Voice control

Steps	User says	System answer
1	"PHONE"	"PHONE"
2	"DELETE NAME"	"NAME PLEASE"
3	"<name>"	"DELETE <name>" "CONFIRM YES OR NO"
4	"YES"	"<name> DELETED"
	"NO"	"COMMAND CANCELLED"

Play directory

Use this function to let the system tell you all stored entries.

Steps	User says	System answer
1	"PHONE"	"PHONE"
2	"PLAY DIRECTORY"	"PLAY DIRECTORY"

Delete directory

This function allows you to delete all entries in one go.

Steps	User says	System answer
1	"PHONE"	"PHONE"
2	"DELETE DIRECTORY"	"DELETE DIRECTORY" "CONFIRM YES OR NO"
3	"YES"	"DIRECTORY DELETED"
	"NO"	"COMMAND CANCELLED"

Main settings

Reject calls

Calls can be set to be automatically rejected using voice control.

Voice control

Steps	User says	System answer
1	"PHONE"	"PHONE"
2	"REJECT CALLS"	"REJECT CALLS"
	"ACCEPT CALLS"*	"ACCEPT CALLS"

* use this command to turn the reject mode off

NAVIGATION SYSTEM COMMANDS

Please refer to your separate Navigation manual for details of the command menus.

Overview

The overview below shows the available voice commands. The following lists will give further information about the complete command menu in selected examples.

CLIMATE CONTROL COMMANDS

Climate

The climate voice commands supports the functionality of the fan speed, temperature and mode settings. Not all functions are available on all vehicles.

"CLIMATE"
"HELP"
"FAN"*
"DEFROSTING/DEMISTING ON"*
"DEFROSTING/DEMISTING OFF"*
"TEMPERATURE"*
"AUTO MODE"*

* Can be used as a shortcut. On vehicles fitted with an English language module the "FAN" shortcut is not available.

Voice control

Fan

This function allows you to adjust the fan speed.

Steps	User says	System answer
1	"CLIMATE"	"CLIMATE"
2	"FAN"*	"FAN SPEED PLEASE"
3	"MINIMUM"	"FAN MINIMUM"
	"<a number between 1 and 7>"	"FAN <number>"
	"MAXIMUM"	"FAN MAXIMUM"

* Can be used as a shortcut. On vehicles fitted with an English language module the "FAN" shortcut is not available.

Defrosting/Demisting

Steps	User says	System answer
1	"CLIMATE"	"CLIMATE"
2	"DEFROSTING ON/DEMISTING ON"*	"DEFROSTING ON/DEMISTING ON"
	"DEFROSTING OFF/DEMISTING OFF"*	"DEFROSTING OFF/DEMISTING OFF"

* Can be used as a shortcut.

Temperature

This function allows you to adjust the temperature.

Steps	User says	System answer
1	"CLIMATE"	"CLIMATE"
2	"TEMPERATURE"*	"TEMPERATURE PLEASE"
3	"MINIMUM"	"TEMPERATURE MINIMUM"

Voice control

Steps	User says	System answer
	"<a number between 15 and 29 °C with 0.5 increments>" or "<a number between 59 and 84 °F>"	"TEMPERATURE <number>"
	"MAXIMUM"	"TEMPERATURE MAXIMUM"

* Can be used as a shortcut.

Auto mode





Steps	User says	System answer
1	"CLIMATE"	"CLIMATE"
2	"AUTO MODE"*	"AUTO MODE"

* Can be used as a shortcut. Can be deactivated by selecting a different temperature or fan speed.

Connectivity

GENERAL INFORMATION

CAUTIONS

-  Take care when handling external devices with exposed electrical connectors (such as the USB plug). Always replace the protective cap/shield when possible. There may be a risk of electrostatic discharge causing damage to the device.
-  Do not touch or handle the USB socket in the vehicle. Cover the socket when not in use.
-  Only use USB Mass-Storage device compliant devices.
-  Always switch your audio unit to a different source (for example the radio) before unplugging the USB device.
-  Do not install or connect USB hubs or splitters.

Note: *The system is only designed to recognize and read suitable audio files from a USB device that conforms to the USB Mass-Storage device class or an iPod. Not all available USB devices can be guaranteed to function with the system.*

Note: *It is possible to connect compatible devices with a trailing USB lead as well as those that plug into the vehicle USB socket directly (for example USB memory sticks and pen drives).*

Note: *Some USB devices with a higher power consumption may not be compatible (for example some larger hard drives).*

Note: *Access time to read the files on the external device will vary depending upon factors such as the file structure, size and device content.*

The system supports a range of external devices, to fully integrate with your audio unit via the USB and auxiliary input sockets. Once connected, control of the external device is possible via the audio unit.

A list of typical compatible devices are shown below:

- USB memory sticks
- USB portable hard drives
- Some MP3 players with USB connection
- iPod media players (refer to **www.ford-mobile-connectivity.com** for latest compatibility list).

The system is USB 2.0 full speed compatible, USB 1.1 host compliant and supports FAT 16/32 file systems.

Information on audio file structures for external devices

USB

Create only a single partition on the USB device.

We recommend that you put MP3 files in a folder.

If playlists are created, they must contain correct file paths referenced to the USB device. It is recommended to create the playlist after the audio files have been transferred to the USB device.

Playlists must be created in .m3u format.

Audio files must be in .mp3 format.

Do not exceed the following limits:

- 1000 items per folder (files, folders and playlists)
- 5000 folders per USB device (including playlists)
- 8 subfolder levels.

Connectivity

To enable voice control for custom playlists and folders, follow the procedure below:

- Create folders named with the structure "**Ford<*>**" where <*> is a number 1-10. For example "**Ford3**" without an extension.
- Create playlists named with the structure "**Ford<*>.m3u**" where <*> is a number 1-10. For example "**Ford5.m3u**" without any space between "**Ford**" and the number.

Thereafter, custom folders and playlists will be selectable with voice control. See **Audio unit commands** (page 301).

iPod

To enable voice control for custom playlists, create playlists named with the structure "**Ford<*>**" where <*> is a number 1-10. For example "**Ford7**" without any space between "**Ford**" and the number.

Thereafter, playlists will be selectable with voice control. See **Audio unit commands** (page 301).

CONNECTING AN EXTERNAL DEVICE

WARNING



Make sure the external device is securely mounted within the vehicle, and that trailing connections do not obstruct any of the driving controls.

External devices may be connected using the auxiliary input socket and the USB port. See **Auxiliary Input Socket** (page 142). See **USB Port** (page 143).

Connection

Plug in the device, and if necessary secure it to prevent movement within the vehicle.

Connecting an iPod

For optimum convenience and audio quality, we recommend that you purchase a dedicated single connection lead available from your dealer.

Alternatively, it is possible to connect your iPod using the standard iPod USB cable and a separate 3.5mm audio jack lead. If using this method preset the iPod volume to maximum and turn off any equalizer settings before making the connections:

- Connect the headphone output of the iPod to the AUX IN socket.
- Connect the USB cable from the iPod to the vehicle USB socket.

CONNECTING AN EXTERNAL DEVICE - VEHICLES WITH: BLUETOOTH

Connecting a Bluetooth audio device

CAUTION



As various standards exist, manufacturers are able to implement a variety of profiles in their Bluetooth devices. Because of this, an incompatibility can occur between the Bluetooth device and the system, which in some cases may limit system functionality. To avoid this situation, only recommended devices should be used.

Please visit the website www.ford-mobile-connectivity.com for full details.

Connectivity

Bonding the device

Note: Some audio and navigation units have a separate Bluetooth audio menu. Use this to access setup and control.

To connect the device to the system follow the same procedure as for Bluetooth hands free phones. See **Bluetooth setup** (page 293).

Operating the device

Select Bluetooth audio as the active source.

Tracks can be accessed by skipping forwards and backwards using the steering wheel controls, or directly from the audio unit controls.

USING A USB DEVICE

Various icons are used to identify types of audio file, folders etc.



USB device is the active source



Folder



Playlist



Album



Artist



Filename



Track title



Information not available

Sony radio

Operation

Select the USB device as the audio source by repeatedly pressing the **CD/AUX** button until USB appears in the display. After first connecting the USB device, the first track within the first folder will start to play automatically. Subsequently, following audio source switching, the position of playback on the USB device is remembered.

To browse the device contents, press the up/down arrow key or the OK button once.

The display will show the track information, together with other important information described below:

- A vertical scroll bar on the right side of the display shows the current position of the folder view.
- ">" after an entry indicates a further level down is readable (for example a folder named after an album, with individual album tracks within that folder).
- "<" before the list indicates that a further level up is readable.
- Icons to the left of track/folder text indicate the type of file/folder. Refer to the list for an explanation of these icons.

To navigate the USB device contents, use the up/down arrow keys to scroll through lists, and the left/right keys to move up or down within the folder hierarchy. Once your desired track, playlist or folder is highlighted, press the OK button to select playback.

Note: If you wish to jump to the top level of the USB device contents, press and hold the left arrow key.

Connectivity

Audio control

Press the left and right arrow keys to skip backwards and forwards through tracks.

Press and hold the left/right arrow keys to enable fast rewind/fast forward through track content.

Press the up/down arrow key or the OK button to browse the device contents.

Press the MENU key to enter the USB menu. It is possible to enable shuffle and repeat functions here with respect to folders and playlists.

Press the SCAN button to scan the whole device, current folder or a playlist if it is in operation.

Press the **INFO** button to display the following:

- filename
- title
- artist
- album
- track number and playing time.

Repeated button presses will scroll through these displays.

CD Navigation units

Operation

Select the USB device as the audio source by pressing the **CD/AUX** button until DEVICES appears in the display. Select DEVICES and then select USB from the available device list. After first connecting the USB device, the first track within the first folder will start to play automatically. Subsequently, following audio source switching, the position of playback on the USB device is remembered.

To browse the device contents, press the **SELECT** button once.

The display will show the track information, together with other important information described below:

- A vertical scroll bar on the right side of the display shows the current position of the folder view.
- ">" after an entry indicates a further level down is readable (for example a folder named after an album, with individual album tracks within that folder).
- "<" to the left hand side of the display indicates that a further level up is readable.
- Icons to the left of track/folder text indicate the type of file/folder. Refer to the list for an explanation of these icons.

To navigate the USB device contents, use the rotary scroll/select button to browse through lists. Push the button to expand the contents within the highlighted playlist or folder, or to commence playback of a particular track. Press **ESC** to go up one level.

Audio control

Press the **SEEK** up and down keys to skip backwards and forwards through tracks.

Press and hold the **SEEK** keys to enable fast rewind/fast forward through track content.

Rotate or press the **SELECT** button to browse the device contents.

Press SHUFFLE or REPEAT buttons to enable shuffle and repeat functions with respect to folders and playlists. Different options may appear depending upon whether or not a playlist is in operation.

Press the SCAN button to scan the current playlist if it is in operation, or the complete USB device or folder.

Connectivity

Press the **INFO** button to display the following:

- filename
- title
- artist
- album
- track number and playing time.

SD Navigation units

Operation

Select the USB device as the audio source by pressing the **CD/AUX** button until the USB button appears to the left of the display. Select USB from the available device list.

Note: *Some devices may be shown but not selectable, depending if the device is connected or not.*

After first connecting the USB device, the first track within the first folder will start to play automatically. Subsequently, following audio source switching, the position of playback on the USB device is remembered.

To browse the device contents, press the scroll up or down arrow button.

The display will show the track information, together with other important information described below:

- A vertical scroll bar on the right side of the display shows the current position of the folder view.
- ">" after an entry indicates a further level down is readable (for example a folder named after an album, with individual album tracks within that folder).

- "<" to the left hand side of the display indicates that a further level up is readable.
- Icons to the left of track/folder text indicate the type of file/folder. Refer to the list for an explanation of these icons.

To navigate the USB device contents, use the scroll buttons to browse through lists. Push the button to expand the contents within the highlighted playlist or folder, or to commence playback of a particular track. Press the left arrow key to go up one level.

Audio control

Press the **SEEK** up and down keys to skip backwards and forwards through tracks.

Press and hold the **SEEK** keys to enable fast rewind/fast forward through track content.

Press the scroll bar arrow keys to browse the device contents.

Press SHUFFLE or REPEAT buttons to enable shuffle and repeat functions with respect to folders and playlists.

Press the SCAN button to scan the current playlist if it is in operation, or the complete USB device or folder.

Press the **INFO** button to display the following:

- filename
- title
- artist
- album
- track number and playing time.

USING AN IPOD

Various icons are used to identify types of audio file, folders etc.

Connectivity



iPod is the active source



iPod playlist



iPod artist



iPod album



iPod genre



iPod song



iPod generic category



iPod generic media file

Sony radio

Operation

Connect the iPod. See **Connecting an external device** (page 319).

Select the iPod as the audio source by repeatedly pressing the **CD/AUX** button until iPod appears in the display.

The iPod menu list for browsing contents will be available through the radio display. Navigation of the contents follows the same principles as for iPod standalone use (for example search by artist, title, etc.). To browse the iPod contents, press the up/down arrow key or the OK button once.

The display will show the track information, together with other important information described below:

- A vertical scroll bar on the right side of the display shows the current position of the list view.
- ">" after an entry indicates a further level down is readable (for example all albums by a particular artist).
- "<" before the list indicates that a further level up is readable.
- An icon on the left side indicates the type of the currently displayed list (for example list of albums). Refer to the list for an explanation of these icons.

To navigate the iPod contents, use the up/down arrow keys to scroll through lists, and the left/right keys to move up or down within the hierarchy. Once your desired track, playlist, album, artist or genre is highlighted, press the OK button to select playback.

Note: *If you wish to jump to the top level of the iPod contents, press and hold the left arrow key.*

Audio control

Press the left and right arrow keys to skip backwards and forwards through tracks.

Press and hold the left/right arrow keys to enable fast rewind/fast forward through track content.

Press the up/down arrow key or the OK button to browse the iPod contents.

Press the **MENU** key to enter the iPod menu. It is possible to enable shuffle and repeat functions here. It is also possible to enable the iPod "Shuffle songs" option directly from the top level.

Press the **SCAN** button to scan the currently selected tracks.

Connectivity

Press the **INFO** button to display the following:

- title
- artist
- track number and playing time.

Repeated button presses will scroll through these displays.

CD Navigation units

Operation

Connect the iPod. See **Connecting an external device** (page 319).

Select the iPod as the audio source by pressing the **CD/AUX** button until **DEVICES** appears in the display. Select **DEVICES** and then select iPod from the available device list.

The iPod menu list for browsing contents will be available through the display. Navigation of the contents follows the same principles as for iPod standalone use (for example search by artist, title, etc.). To browse the iPod contents, press the **SELECT** button once.

The display will show the track information, together with other important information described below:

- A vertical scroll bar on the right side of the display shows the current position of the list view.
- ">" after an entry indicates a further level down is readable (for example all albums by a particular artist).
- "<" before the list indicates that a further level up is readable.
- An icon on the left side indicates the type of the currently displayed list (for example list of albums). Refer to the list for an explanation of these icons.

To navigate the iPod contents, use the rotary scroll/select button to browse through lists. Push the button to expand the contents within the highlighted playlist, album, artist, genre or to commence playback of a particular track. Press **ESC** to go up one level.

Audio control

Press the **SEEK** up and down keys to skip backwards and forwards through tracks.

Press and hold the **SEEK** keys to enable fast rewind/fast forward through track content.

Rotate or press the **SELECT** button to browse the iPod contents.

Press the **MENU** key to enter the iPod menu. It is possible to enable shuffle and repeat functions here. It is also possible to enable the iPod "Shuffle songs" option directly from the top level.

Press the **SCAN** button to scan the currently selected tracks.

Press the **INFO** button to display the following:

- title
- artist
- track number and playing time.

SD Navigation units

Operation

Connect the iPod. See **Connecting an external device** (page 319).

Select the iPod as the audio source by pressing the **CD/AUX** button until the iPod button appears to the left of the display. Select iPod from the available device list.

Note: *Some devices may be shown but not selectable, depending if the device is connected or not.*

Connectivity

The iPod menu list for browsing contents will be available through the display. Navigation of the contents follows the same principles as for iPod standalone use (for example search by artist, title, etc.). To browse the iPod contents, press the scroll up or down arrow button.

The display will show the track information, together with other important information described below:

- A vertical scroll bar on the right side of the display shows the current position of the list view.
- ">" after an entry indicates a further level down is readable (for example all albums by a particular artist).
- "<" before the list indicates that a further level up is readable.
- An icon on the left side indicates the type of the currently displayed list (for example list of albums). Refer to the list for an explanation of these icons.

To navigate the iPod contents, use the scroll buttons to browse through lists. Push the button to expand the contents within the highlighted playlist, album, artist, genre or to commence playback of a particular track. Press the left arrow key to go up one level.

Audio control

Press the **SEEK** up and down keys to skip backwards and forwards through tracks.

Press and hold the **SEEK** keys to enable fast rewind/fast forward through track content.

Press the scroll bar arrow keys to browse the iPod contents.

Press the MENU key to enter the iPod menu. It is possible to enable shuffle and repeat functions here. It is also possible to enable the iPod "Shuffle songs" option directly from the top level.

Press the SCAN button to scan the currently selected tracks.

Press the **INFO** button to display the following:

- title
- artist
- track number and playing time.

Navigation introduction

ROAD SAFETY

WARNINGS



The system provides you with information designed to help you reach your destination quickly and safely.



For reasons of safety, the driver should only program the system when the vehicle is stationary.



The system provides no assistance with respect to stop signs, traffic lights, areas under construction or other important safety information.



Do not use the system until you have familiarised yourself with its operation.



Only view the system display when driving conditions permit.

Safety information

Read and follow all stated safety precautions. Failure to do so may increase your risk of collision and personal injury. Ford Motor Company shall not be liable for any damages of any type arising from failure to follow these guidelines.

If detailed viewing of route instructions is necessary, pull off the road when it is safe to do so and park your vehicle.

Do not use the navigation system to locate emergency services.

To use the system as effectively and safely as possible, always use the latest navigation information. Your dealer will be able to assist with this.

Navigation system

GETTING STARTED

CAUTION

 Using the system with the engine off will drain the battery.

Note: You will be charged when sending and receiving text messages.

Note: Refer to your phone handbook for all phone functions and operation.

Note: Keep the activation code (printed on the installation guide) in a safe place.

Note: Retain the activation text message in your mobile phone inbox.

Compatibility of phones

CAUTION

 As no common agreement exists, mobile phone manufacturers are able to implement a variety of profiles in their Bluetooth devices. Because of this, an incompatibility can occur between the phone and hands-free system, which in some cases may significantly degrade the system performance. To avoid this situation, only recommended phones should be used.

Please visit the website www.ford-mobile-connectivity.com for full details.

Installing the micro SD card

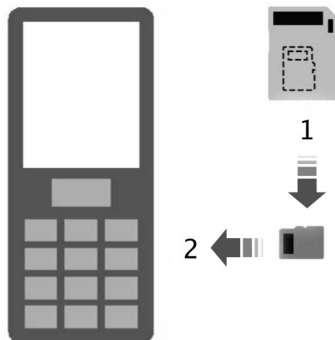

E114212

1. Remove the micro SD card from the adaptor.
2. Insert the micro SD card into the mobile phone.

Activating the mobile phone navigation system

Note: The radio must be switched on before connecting the mobile phone to the in-car GPS receiver.

Note: The Ford Mobile Navigation must be installed and activated on your mobile phone.

Note: It is possible to activate up to a **maximum** of three phones.

Note: Detailed instructions are available on the micro SD card and at www.ford-mobile-connectivity.com.

To connect the device to the system follow the same procedure as for Bluetooth hands free phones. See **Bluetooth setup** (page 293).

1. Switch the radio on.

Navigation system



E114213

2. Switch your mobile phone on and start the "Ford Mobile Navigation".
3. Choose "Select Destination".
4. Choose "Enter Address".
5. Change route options if necessary and start the route guidance.
6. The vehicle display will show the turn information. Voice instructions are heard via the vehicle speakers.

Note: *Your mobile phone will display your current position.*

7. You are able to exit the application and continue your route guidance after restarting the application.

Appendices

TYPE APPROVALS

FCC/INDUSTRY CANADA NOTICE

This device complies with Part 15 of the FCC Rules. Operation is subject to the following two conditions: (1) this device may not cause harmful interference, and (2) this device must accept any interference received, including interference that may cause undesired operation.

FCC ID: WJLRX-42

IC: 7847A-RX42

Changes or modifications to your device not expressly approved by the party responsible for compliance can void the user's authority to operate the equipment.

RX-42 - declaration of conformity

We, the party responsible for compliance, declare under our sole responsibility that the Handset Integration product RX-42 is in conformity with the provisions of the following Council Directive: 1999/5/EC. A copy of the Declaration of Conformity can be found at:

www.novero.com/declaration_of_conformity

The Bluetooth word mark and logos are owned by the Bluetooth SIG, Inc. and any use of such marks by Ford Motor Company is under license. Other trademarks and trade names are those of their respective owners.

TYPE APPROVALS

iPod is a trademark of Apple Inc.

TYPE APPROVALS



© 2008 NAVTEQ B.V. All rights reserved.

Appendices

(AT)	"© Bundesamt für Eich- und Vermessungswesen"
(PL)	"© EuroGeographics"
(FR)	"source: GéoRoute® IGN France & BD Cartho® IGN France"
(DE)	"Die Grundlagendaten wurden mit Genehmigung der zuständigen Behörden entnommen"
(GB)	"Based upon Crown Copyright material."
(GR)	"Copyright Geomatics Ltd."
(IT)	"La Banca Dati Italiana è stata prodotta usando quale riferimento anche cartografia numerica ed al tratto prodotta e fornita dalla Regione Toscana."
(NO)	"Copyright © 2000; Norwegian Mapping Authority"
(PT)	"Source: IgeoE – Portugal"
(ES)	"Información geográfica propiedad del CNIG"
(SE)	"Based upon electronic data © National Land Survey Sweden."
(CH)	"Topografische Grundlage: © Bundesamt für Landestopographie"

TYPE APPROVALS

EU Declaration

Hereby, Valeo declares that this short range device is in compliance with the essential requirements and other relevant provisions of Directive 1999/5/EC.

Certificate for United Arab Emirates



E125209

ER-GEN-00-0002-24





Appendices

ELECTROMAGNETIC COMPATIBILITY

WARNINGS

 Your vehicle has been tested and certified to legislations relating to electromagnetic compatibility (72/245/EEC, UN ECE Regulation 10 or other applicable local requirements). It is your responsibility to ensure that any equipment you have fitted complies with applicable local legislations. Have any equipment fitted by properly trained technicians.

WARNINGS

-  The RF (radio frequency) transmitter equipment (e.g. cellular telephones, amateur radio transmitters etc.) may only be fitted to your vehicle if they comply with the parameters shown in the table below. There are no special provisions or conditions for installations or use.
-  Do not mount any transceiver, microphones, speakers, or any other item in the deployment path of the airbag system.
-  Do not fasten antenna cables to original vehicle wiring, fuel pipes and brake pipes.
-  Keep antenna and power cables at least 10 centimetres (4 inches) from any electronic modules and airbags.

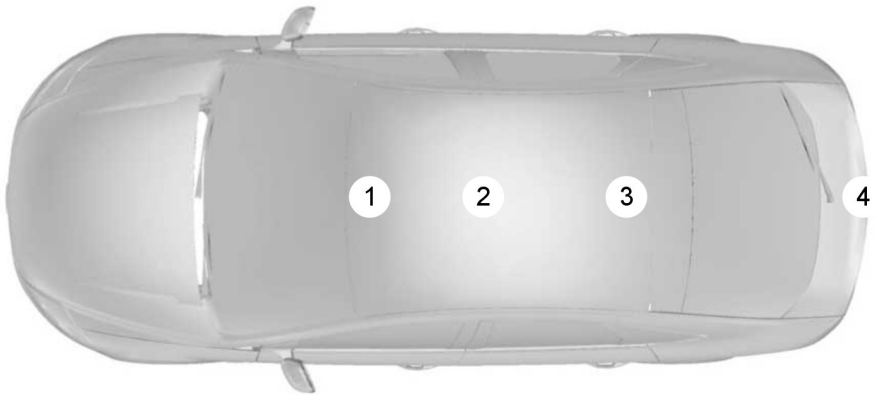

E85998

Frequency Band MHz	Maximum output power Watt (Peak RMS)	Antenna Positions
1 – 30	50 W	3, 4
30 – 54	50 W	1, 2, 3
68 – 87.5	50 W	1, 2, 3

Appendices

Frequency Band MHz	Maximum output power Watt (Peak RMS)	Antenna Positions
142 – 176	50 W	1, 2, 3
380 – 512	50 W	1, 2, 3
806 – 940	10 W	1, 2, 3
1200 – 1400	10 W	1, 2, 3
1710 – 1885	10 W	1, 2, 3
1885 – 2025	10 W	1, 2, 3

Note: After the installation of RF transmitters, check for disturbances from and to all electrical equipment in the vehicle, both in the standby and transmit modes.

Check all electrical equipment:

- with the ignition **ON**
- with the engine running
- during a road test at various speeds.

Check that electromagnetic fields generated inside the vehicle cabin by the transmitter installed do not exceed applicable human exposure requirements.

Index

A

About This Manual.....	7
Protecting the Environment.....	7
Active suspension.....	173
Principle of Operation.....	173
Adaptive cruise control (ACC).....	181
Principle of Operation.....	181
Adaptive Headlamps.....	59
Cornering lamps.....	60
Adjusting the Headlamps - Vehicles With: Adaptive Front Lighting/Xenon Headlamps.....	57
Adjusting the Steering Wheel.....	48
Adjusting the windscreen washer jets.....	51
Air Vents.....	111
Front air vents.....	111
Second row air vents.....	112
Third row air vents.....	112
Alarm.....	45
Principle of Operation.....	45
Alternative frequencies.....	284
All except Sony and Sony DAB.....	284
Sony and Sony DAB.....	284
Appendices.....	329
Arming the alarm.....	47
Arming the engine immobiliser.....	44
Ashtray.....	137
Front ashtray.....	137
Rear ashtray.....	137
At a Glance.....	9
Adjusting the steering wheel.....	13
Autolamps.....	14
Automatic climate control.....	16
Automatic main beam control.....	14
Automatic transmission.....	18
Autowipers.....	13
Blind spot information system (BLIS).....	15
Changing the wiper blades.....	13
Diesel particulate filter (DPF).....	17
Direction indicators.....	14
Driver alert.....	19
Electric child safety locks.....	12
Electric folding mirrors.....	15
Electric parking brake (EPB).....	18
Electric windows.....	14
Engine idle speed after starting.....	16
Fuel filler flap.....	17
Information displays.....	15
Instrument panel overview - left-hand drive.....	9
Instrument panel overview - right-hand drive.....	10
Keyless entry.....	12
Keyless starting.....	16
Lane departure warning.....	20
Manual climate control.....	15
Manual transmission.....	18
Rear view camera.....	19
Reverse mirror dipping.....	15
Speed limiter.....	19
Towing the vehicle on four wheels.....	20
Audible Warnings and Indicators.....	87
Switching the chimes on and off.....	87
Audio Control.....	48
Mode.....	48
Seek.....	49
Audio distortion reduction (CLIP).....	283
All except Sony and Sony DAB.....	283
Sony and Sony DAB.....	283
Audio introduction.....	271
Audio menu control.....	277
Sony CD and Sony CD DAB with Bluetooth.....	279
Audio System Security.....	275
Audio troubleshooting.....	292
Audio Troubleshooting.....	292

Index

Audio Unit Clock and Date	
Displays.....	276
Audio unit commands.....	301
Auxiliary input.....	307
CD Changer.....	302
CD Player.....	301
External devices - iPod.....	309
External devices - USB.....	307
Radio.....	304
Audio unit menus.....	283
Audio unit operation.....	277
Audio unit overview.....	272
Auto-Dimming Mirror.....	78
Autolamps.....	55
Automatic Climate Control.....	115
Air distribution.....	117
Blower.....	116
Mono mode.....	116
Rear air conditioning (triple-zone automatic climate control).....	118
Recirculated air.....	117
Setting the temperature.....	116
Switching the air conditioning on and off.....	117
Switching the automatic climate control on and off.....	117
Windscreen defrosting and demisting.....	117
Automatic Main Beam Control.....	55
Activating the system.....	56
Manually overriding the system.....	57
Setting the system sensitivity.....	57
Automatic Transmission.....	162
Drive modes.....	163
Emergency park position release lever.....	163
Hints on driving with an automatic transmission.....	163
Selector lever positions.....	162
Automatic volume control.....	283
All except Sony and Sony DAB.....	283
Sony and Sony DAB.....	283
Autostore control.....	279
6000CD.....	280
Sony CD.....	280
Autowipers.....	50
Auxiliary Heater.....	119
Changing the remote control battery.....	123
Diesel auxiliary heater (depending on country).....	124
Feedback during starting and switching off.....	122
Fuel operated heater (depending on country).....	123
Parking heater.....	119
Programming the transmitter.....	123
Remote start in combination with direct start or timer.....	122
Remote starting.....	122
Auxiliary input (AUX IN) socket.....	291
Auxiliary Input Socket.....	142
Auxiliary Power Points.....	137
Galaxy.....	138
S-Max.....	138

B	
Balance/fade control.....	277
6000CD.....	277
Sony and Sony DAB.....	277
Bass/treble control.....	277
6000CD.....	277
Sony and Sony DAB.....	277
Battery connection points.....	252
Blind Spot Monitor.....	79
Blind spot information system (BLIS).....	79
Detection errors.....	81
System detection and alerts.....	80
Turning the system on and off.....	81
Using the system.....	79
Bluetooth setup.....	293
Handling of phones.....	293
Requirements for Bluetooth connection.....	293
Booster Seats.....	22
Booster cushion (Group 3).....	23
Booster seat (Group 2).....	22
Brake and Clutch Fluid Check.....	245
Brakes.....	165
Principle of Operation.....	165
Bulb Specification Chart.....	72

Index

C

Capacities and Specifications.....	267
Technical Specifications.....	267
Cargo Nets.....	198
Luggage retention net - type 1.....	198
Luggage retention net - type 2.....	200
Catalytic Converter.....	155
Driving with a catalytic converter.....	155
CD changer.....	142
Changing a Bulb.....	64
Approach lamp.....	66
Central high mounted brake lamp.....	70
Daytime running lamps.....	65
Front fog lamp and side lamp (Galaxy).....	67
Front fog lamp and side lamp (S-MAX).....	66
Headlamp.....	64
Interior lamps.....	70
Luggage compartment lamp and tailgate lamp.....	72
Number plate lamp.....	70
Reading lamps.....	71
Rear lamp (Galaxy).....	69
Rear lamps (S-MAX).....	68
Side repeater.....	66
Vanity mirror lamp.....	72
Changing a Fuse.....	221
Changing a Road Wheel.....	253
Installing a road wheel.....	255
Jacking and lifting points.....	253
Locking wheel nuts.....	253
Removing a road wheel.....	254
Vehicle jack.....	253
Changing the 12V Battery.....	252
Changing the remote control battery.....	34
Remote control with a folding key blade.....	34
Remote control without a folding key blade.....	35
Changing the Wiper Blades.....	52
Rear window wiper blades.....	53
Windscreen wiper blades.....	52
Checking the Wiper Blades.....	52
Childminder Mirror.....	142
Child Safety.....	21
Child Safety Locks.....	27
Electric child safety locks.....	27
Manual child safety locks.....	27
Child Seat Positioning.....	23
Child Seats.....	21
Child restraints for different mass groups.....	21
Cigar Lighter.....	137
Cleaning the Exterior.....	249
Body paintwork preservation.....	250
Cleaning the alloy wheels.....	249
Cleaning the chrome trim.....	249
Cleaning the headlamps.....	249
Cleaning the rear window.....	249
Cleaning the Interior.....	250
Instrument cluster screens, LCD screens, radio screens.....	250
Rear windows.....	250
Seat belts.....	250
Climate Control.....	111
Principle of Operation.....	111
Climate control commands.....	315
Climate.....	315
Clock.....	136
Coded keys.....	44
Cold Weather Precautions.....	217
Compact disc playback.....	287
Compact disc changer playback.....	287
Compact Disc Player.....	286
Compact disc track compression.....	288
All except Sony and Sony DAB.....	288
Sony and Sony DAB.....	288
Compact disc track scanning.....	288
6000CD.....	288
Sony and Sony DAB.....	288
Connecting an external device.....	319
Connection.....	319
Connecting an external device - Vehicles With: Bluetooth.....	319
Connecting a Bluetooth audio device.....	319
Connectivity.....	318
General Information.....	318
Convenience features.....	135
Cruise Control.....	179
Principle of Operation.....	179
Cup Holders.....	138
Seat back trays.....	138

Index

D	
Daytime Running Lamps.....	55
Diesel Particulate Filter.....	149
Regeneration.....	149
Digital signal processing (DSP).....	283
Changing the DSP settings.....	283
DSP equaliser.....	283
DSP occupancy.....	283
Direction Indicators.....	60
Disabling the passenger airbag.....	32
Disabling the passenger airbag.....	32
Enabling the passenger airbag.....	33
Fitting the passenger airbag deactivation switch.....	32
Disarming the alarm.....	47
Vehicles with keyless entry.....	47
Vehicles without keyless entry.....	47
Disarming the engine immobiliser.....	44
Dog Guard.....	207
Installing the dog guard.....	207
Driver Alert.....	189
Principle of Operation.....	189
Driving Hints.....	217
Driving Through Water.....	217
Driving through water.....	217
E	
Eco Mode.....	153
Principle of Operation.....	153
Ejecting compact discs.....	288
6000CD.....	289
Sony CD.....	289
Electric exterior mirrors.....	76
Electric folding mirrors.....	76
Mirror tilting positions.....	76
Reverse mirror dipping.....	77
Electric Parking Brake.....	166
Applying the EPB.....	166
Applying the EPB when the vehicle is moving.....	167
Automatic application of the EPB.....	166
Cut in the power supply.....	168
Parking on a hill.....	166
Preventing automatic application of the EPB.....	167
Releasing the EPB.....	167
Electromagnetic compatibility.....	331
Ending compact disc playback.....	290
Engine Block Heater.....	149
Engine Coolant Check.....	244
Checking the coolant level.....	244
Topping up.....	244
Engine immobiliser.....	44
Principle of Operation.....	44
Engine Oil Check.....	244
Checking the oil level.....	244
Topping up.....	244
Engine Oil Dipstick - 1.6L Duratorq-TDCi (DV) Diesel/2.0L Duratorq-TDCi (DW) Diesel/2.2L Duratorq-TDCi (DW) Diesel.....	243
Engine Oil Dipstick - 1.6L EcoBoost SCTi (Sigma).....	243
Engine Oil Dipstick - 2.0L Duratec-HE (M14)/2.3L Duratec-HE (M14).....	243
Engine Oil Dipstick - 2.0L EcoBoost SCTi (M14).....	243
Entering a security code.....	275
6000CD, Sony and Sony DAB.....	275
Exterior Mirrors.....	76
Manual folding mirrors.....	76
F	
Fastening the seat belts.....	30
Second row centre seat belt.....	30
Fast forward/reverse.....	287
All except Sony and Sony DAB.....	287
Sony and Sony DAB.....	287
First Aid Kit.....	219
Floor Mats.....	217
Forward alert function.....	186
Adjusting the warning sensitivity.....	186
Switching the system on and off.....	186
Front Fog Lamps.....	57
Front Seat Armrest.....	134
Fuel and Refuelling.....	154
Technical Specifications.....	157
Fuel Consumption.....	157
Fuel filler flap.....	155
Refuelling with a fuel can.....	157
Fuel Quality - Diesel.....	154
Long-term storage.....	155

Index

Fuel Quality - E85.....	154	Hill Start Assist.....	170
Long-term storage.....	154	Principle of Operation.....	170
Fuel Quality - Petrol.....	154	Hints on Driving With Anti-Lock	
Fuse Box Locations.....	220	Brakes.....	165
Central fuse box.....	220		
Engine compartment fuse box.....	220		
Rear fuse box.....	220		
Fuses.....	220		
Fuse Specification Chart.....	222	Ignition Switch.....	144
Central fuse box.....	226	Important audio information.....	271
Engine compartment fuse box.....	222	Audio unit labels.....	271
Rear fuse box.....	228	Disc labels.....	271
G		Incorrect security code.....	275
Gauges.....	82	Information Displays.....	88
Engine coolant temperature gauge.....	83	General Information.....	88
Fuel gauge.....	84	Information Messages.....	101
General Information on Radio		Active suspension.....	102
Frequencies.....	34	Airbag.....	102
Getting started.....	327	Alarm.....	102
Activating the mobile phone navigation		Automatic main beam control, Lane	
system.....	327	departure warning and Driver alert.....	102
Compatibility of phones.....	327	Battery and charging system.....	103
Installing the micro SD card.....	327	Blind spot monitor.....	103
Glasses Holder.....	141	Child power lock.....	104
Global Opening and Closing.....	39	Climate control.....	104
Global closing.....	40	Cruise control and Adaptive cruise control	
Global opening.....	39	(ACC).....	104
Glove Box.....	138	Doors open.....	104
Cooled glove box.....	138	Electric parking brake (EPB).....	107
		Engine immobiliser.....	105
H		Hill start assist.....	105
Hazard Warning Flashers.....	60	Keyless system.....	105
Headlamp Levelling.....	58	Lighting.....	106
Recommended headlamp levelling switch		Maintenance.....	107
positions.....	58	Message indicator.....	101
Headlamp Washers.....	51	Message symbols.....	101
Head Restraints.....	128	Occupant protection.....	107
Adjusting the head restraint.....	128	Parking brake.....	107
Removing the head restraint.....	128	Power steering.....	108
Heated Seats.....	132	Stability control (ESP).....	108
Raising and Lowering the		Start-stop.....	108
Temperature.....	133	Transmission.....	109
Heated Windows and Mirrors.....	119	Tyre pressure monitoring system.....	109
Heated exterior mirrors.....	119	Viewing current messages.....	101
Heated windows.....	119	Voice control.....	110
		Instrument Cluster.....	82
		Instrument Lighting Dimmer.....	136

Index

Interior Lamps.....	61	Lighting Control.....	54
Courtesy lamp.....	61	Headlamp flasher.....	55
LED Interior lighting.....	61	Home safe lighting.....	55
Reading lamps.....	61	Lighting control positions.....	54
Vanity mirror lamps.....	63	Main and dipped beam.....	55
Introduction.....	7	Parking lamps.....	54
ISOFIX Anchor Points.....	26	Lighting.....	54
Attaching a child seat with top		General Information.....	54
tethers.....	26	Load Carrying.....	193
Top tether anchor points.....	26	General Information.....	193
J		Loading compact discs.....	286
Jump-Starting the Vehicle.....	251	6000CD, Sony and Sony DAB.....	286
To connect the booster cables.....	251	Loading the compact disc	
To start the engine.....	252	changer.....	286
K		Load Retaining Fixtures.....	203
Keyless Entry.....	40	Installing the load bracket.....	206
Disabled keys.....	42	Installing the load retaining fixtures.....	204
General information.....	40	Installing the luggage anchor points.....	205
Locking and unlocking the doors with the		Locking and Unlocking.....	37
key blade.....	43	Automatic relocking.....	39
Locking the vehicle.....	41	Central locking.....	37
Passive key.....	41	Double locking.....	37
Unlocking the vehicle.....	42	Double locking the doors with the key.....	37
Keyless Starting.....	144	Locking and unlocking confirmation.....	37
Failure to start.....	145	Locking and unlocking the doors and the	
Ignition on.....	145	luggage compartment lid with the	
Starting a diesel engine.....	145	remote control.....	38
Starting with automatic		Locking and unlocking the doors from	
transmission.....	145	inside.....	38
Starting with manual transmission.....	145	Locking and unlocking the doors with the	
Stopping the engine when the vehicle is		key.....	37
moving.....	146	Luggage compartment lid.....	39
Stopping the engine with the vehicle		reprogramming the unlocking	
stationary.....	146	function.....	39
Keys and Remote Controls.....	34	Locks.....	37
L		Lost security code.....	275
Lane Departure Warning.....	191	Luggage Anchor Points.....	194
Principle of Operation.....	191	Galaxy.....	194
		S-MAX.....	195
		Luggage Covers.....	201
		M	
		Maintenance.....	233
		General Information.....	233
		Technical Specifications.....	246

Index

Manual Climate Control.....	112
Air conditioning.....	113
Air distribution control.....	112
Blower.....	113
Heating the interior quickly.....	113
Recirculated air.....	113
Ventilation.....	113
Manual Seats.....	125
Adjusting the angle of the seatback.....	126
Adjusting the height of the driver's seat.....	126
Adjusting the lumbar support.....	126
Moving the seats backwards and forwards.....	125
Manual Transmission.....	162
Map Pockets.....	140
Memory Function.....	141
Recalling a stored seat position.....	142
Resetting the memory.....	142
Setting a memory pre-set.....	141
MP3 display options.....	290
CD text display options.....	290
MP3 file playback.....	289
6000CD.....	289
Playing a multi session disc.....	289
Sony and Sony DAB.....	289

N

Navigation introduction.....	326
Navigation system commands.....	315
Navigation system.....	327
News broadcasts.....	285
All except Sony and Sony DAB.....	285
Sony and Sony DAB.....	285

O

Occupant protection.....	28
Principle of Operation.....	28
On/off control.....	277
Opening and Closing the Bonnet.....	233
Closing the bonnet.....	234
Opening the bonnet.....	233

P

Parking Aid.....	174
Manoeuvring with the parking aid.....	174
Switching the parking aid on and off.....	174
Parking Aids.....	174
Principle of Operation.....	174
Parking Brake.....	165
Applying the parking brake.....	165
Parking on a hill.....	166
Releasing the parking brake.....	166
Personalised Settings.....	99
Help screen, radio, navigation and phone information.....	99
Language.....	100
Navigation information.....	99
Units of measure.....	100
Power Seats.....	126
2-way electric seat.....	126
8-way electric seat.....	127
Power Steering Fluid Check.....	245
Topping up.....	245
Power Windows.....	74
Anti-trap function.....	75
Driver's door switches.....	74
Front and rear passengers' door switches.....	74
Global opening and global closing.....	74
Opening and closing the windows automatically.....	74
Resetting the memory of the electric windows.....	75
Safety mode.....	76
Safety switch for rear windows.....	75
Programming the remote control.....	34
Programming a new remote control.....	34
Reprogramming the unlocking function.....	34

R

Rear Fog Lamps.....	57
Rear Quarter Windows.....	78
Electric rear quarter windows.....	79
Manual rear quarter windows.....	78

Index

Rear Seats.....	128	Running-In.....	217
Creating a Level Load Floor.....	132	Brakes and clutch.....	217
Second Row Seats.....	128	Engine.....	217
Third Row Seats.....	130	Tyres.....	217
Rear Under Floor Storage.....	197		
S-MAX.....	198	S	
Vehicles with a sliding loadspace floor.....	197	Safety Precautions.....	154
Rear view camera.....	176	Seat Back Trays.....	140
Principle of Operation.....	176	Seat belt height adjustment.....	31
Rear View Camera.....	176	Seat belt reminder.....	31
Activating the rear view camera.....	176	Deactivating the seat belt reminder.....	32
Deactivating the rear view camera.....	178	Seats.....	125
Using the display.....	177	Security code.....	275
Vehicles with parking aid.....	178	Setting the clock and date on the audio unit.....	276
Rear Window Wiper and Washers.....	51	6000CD.....	276
Intermittent wipe.....	51	Sony and Sony DAB.....	276
Reverse gear wipe.....	51	Shuffle/random.....	287
Washer.....	51	6000CD.....	287
Refuelling - E85.....	157	Sony CD and Sony CD DAB.....	288
Refuelling.....	157	Sitting in the Correct Position.....	125
Regional mode (REG).....	284	Sliding Loadspace Floor.....	196
All except Sony and Sony DAB.....	284	Storage compartment.....	196
Sony and Sony DAB.....	285	Speed Limiter.....	187
Removing a Headlamp.....	63	Principle of Operation.....	187
Repairing Minor Paint Damage.....	250	Stability Control.....	169
Repeat compact disc tracks.....	289	Principle of Operation.....	169
6000CD.....	289	Starting a Diesel Engine.....	148
Sony and Sony DAB.....	289	Cold or hot engine.....	148
Replacement Parts		Starting and Stopping the Engine.....	144
Recommendation.....	8	General Information.....	144
Collision Repairs.....	8	Starting a Petrol Engine - E85.....	148
Scheduled Maintenance and Mechanical Repairs.....	8	Starting at low ambient temperatures	148
Warranty on Replacement Parts.....	8	Starting a Petrol Engine.....	147
Retractable tow ball.....	213	Cold or hot engine.....	147
Driving with a trailer.....	216	Engine idle speed after starting.....	147
Maintenance.....	216	Flooded engine.....	147
Swivelling the tow ball in.....	214	Start-Stop.....	151
Swivelling the tow ball out.....	215	Principle of Operation.....	151
Road Safety.....	326	Station preset buttons.....	279
Safety information.....	326	Station tuning control.....	281
Roadside Emergencies.....	219	DAB service linking.....	281
Roof Racks and Load Carriers.....	201	Manual tuning.....	282
Installing the crossbars.....	201	Scan tuning.....	282
Roof rack.....	201	Seek tuning.....	281

Index

Steering Wheel Lock.....	146	Towing a Trailer.....	210
Vehicles with keyless starting.....	146	Steep gradients.....	210
Vehicles without keyless starting.....	146	Towing Points.....	231
Steering Wheel.....	48	Installing the towing eye.....	231
Storage compartments.....	139	Towing eye location.....	231
Front storage compartments.....	139	Towing the Vehicle on Four	
Overhead storage compartments.....	139	Wheels.....	231
Under floor storage compartment.....	140	All vehicles.....	231
Under seat storage compartment.....	139	Vehicles with 2.0L Duratorq-TDCi (DW)	
Sun Shades.....	135	Diesel (Stage V) or 2.0L EcoBoost SCTi	
Roof (Galaxy).....	135	(MI4) and 6-Speed Automatic	
Roof (S-MAX).....	135	Transmission.....	232
Side windows.....	135	Vehicles with automatic transmission,	
Switching Off the Engine.....	149	except 2.0L Duratorq-TDCi (DW) Diesel	
Vehicles with a turbocharger.....	149	(Stage V) or 2.0L EcoBoost SCTi (MI4)	
Symbols Glossary.....	7	with 6-Speed Automatic	
Symbols in this handbook.....	7	Transmission.....	232
Symbols on your vehicle.....	7	Towing.....	210
T		Track selection.....	286
Telephone commands.....	310	All except Sony and Sony DAB.....	286
Create a phonebook.....	313	Sony and Sony DAB.....	286
Main settings.....	314	Traffic information control.....	280
Phone.....	310	Activating traffic announcements.....	280
Phone functions.....	311	Ending traffic announcements.....	281
Telephone controls.....	294	Local or distant traffic.....	280
Remote control.....	294	To adjust the preset volume.....	281
Telephone setup.....	293	Traffic announcement volume.....	281
Bond another Bluetooth phone.....	294	Transmission.....	162
Making a phone an active phone.....	294	Trip Computer.....	97
Phonebook.....	293	Average fuel consumption.....	97
Phonebook categories.....	294	Average speed.....	97
Telephone.....	293	Distance to empty.....	97
General Information.....	293	Odometer.....	97
Temporary Mobility Kit.....	256	Outside air temperature.....	97
Checking the tyre pressure.....	259	Tripmeter.....	97
General information.....	256	Type 1 and 2.....	98
Inflating the tyre.....	257	Type 3.....	98
Using the tyre repair kit.....	257	Type approvals.....	329
Tow Ball.....	210	Certificate for United Arab Emirates.....	330
Driving with a trailer.....	212	EU Declaration.....	330
Driving without a trailer.....	213	FCC/INDUSTRY CANADA NOTICE.....	329
Inserting the tow ball arm.....	211	RX-42 - declaration of conformity.....	329
Maintenance.....	213	Tyre Care.....	260
Removing the tow ball arm.....	212	Tyre Pressure Monitoring System.....	260
Unlocking the tow ball arm		Checking the tyre pressures.....	261
mechanism.....	211	Setting the vehicle load.....	261

Index

U	
Under Bonnet Overview - 1.6L Duratorq-TDCi (DV) Diesel.....	239
Under Bonnet Overview - 1.6L EcoBoost SCTi (Sigma).....	235
Under Bonnet Overview - 2.0L Duratec-HE (M14).....	236
Under Bonnet Overview - 2.0L Duratorq-TDCi (DW) Diesel.....	240
Under Bonnet Overview - 2.0L EcoBoost SCTi (M14).....	237
Under Bonnet Overview - 2.2L Duratorq-TDCi (DW) Diesel.....	242
Under Bonnet Overview - 2.3L Duratec-HE (M14).....	238
Unloading the compact disc changer.....	287
USB Port.....	143
Using active suspension.....	173
Selecting a setting.....	173
System malfunction.....	173
Using Adaptive Cruise Control.....	182
Automatic deactivation.....	185
Changing the set speed.....	183
Setting a speed.....	183
Setting the vehicle gap.....	184
Switching the system off.....	185
Switching the system on.....	183
Temporarily deactivating the system.....	185
Using an iPod.....	322
CD Navigation units.....	324
SD Navigation units.....	324
Sony radio.....	323
Using a USB device.....	320
CD Navigation units.....	321
SD Navigation units.....	322
Sony radio.....	320
Using Cruise Control.....	179
Cancelling the set speed.....	179
Changing the set speed.....	179
Resuming the set speed.....	180
Setting a speed.....	179
Switching cruise control off.....	180
Switching cruise control on.....	179
Using driver alert.....	189
Resetting the system.....	190
Switching the system on and off.....	189
System display.....	190
System warnings.....	189
Using Eco mode.....	153
Resetting Eco mode.....	153
Using hill start assist.....	170
Activating the HLA.....	171
Deactivating the HLA.....	172
Using lane departure warning.....	191
Setting the steering wheel vibration level.....	192
Setting the system sensitivity.....	192
Switching the system on and off.....	191
System warnings.....	192
Using seat belts during pregnancy.....	32
Using Snow Chains.....	260
Vehicles with stability control (ESP).....	260
Using Stability Control.....	169
Vehicles without stability control (ESP) switch.....	169
Vehicles with stability control (ESP) switch.....	169
Using start-stop.....	151
To re-start the engine.....	152
To stop the engine.....	151
Using the speed limiter.....	187
Intentionally exceeding the speed limit.....	187
Setting the speed limit.....	187
System warnings.....	188
Using the telephone - Vehicles With: Navigation System.....	297
Changing the active phone.....	298
Debonding a bonded phone.....	299
Making a call.....	298
Muting the microphone.....	298
Receiving an incoming call.....	298
Receiving a second incoming call.....	298

Index

Using the telephone - Vehicles Without:	
Navigation System.....	295
Changing the active phone.....	297
Debonding a bonded phone.....	297
Debonding a bonded phone - Sony	
radio.....	297
Making a call.....	295
Muting the microphone.....	296
Receiving an incoming call.....	296
Receiving a second incoming call.....	296
Using voice control.....	300
Name tag.....	301
System operation.....	300
Using Winter Tyres.....	260

V

Vehicle battery.....	251
Vehicle Care.....	249
Vehicle Identification Number.....	266
Vehicle Identification Plate.....	265
Vehicle identification.....	265
Vehicle recovery.....	231
Ventilated Seats.....	133
Raising and Lowering the	
Temperature.....	133
Voice control.....	300
Principle of Operation.....	300

W

Warning Lamps and Indicators.....	84
ABS warning lamp.....	84
Airbag warning lamp.....	84
Blind spot monitor indicator.....	84
Brake system lamp.....	84
Coolant temperature warning lamp.....	84
Direction indicators.....	85
Electric parking brake (EPB) warning	
lamp.....	85
Engine warning lamp.....	85
Forward alert indicator.....	85
Front fog lamp indicator.....	85
Frost warning lamp.....	85
Glow plug indicator.....	85
Headlamp indicator.....	85
Ignition warning lamp.....	85
Lane departure warning indicator.....	86
Low fuel level warning lamp.....	86
Main beam indicator.....	86
Message indicator.....	86
Oil pressure warning lamp.....	86
Rear fog lamp indicator.....	86
Seat belt reminder.....	86
Shift indicator.....	86
Stability control (ESP) warning lamp.....	86
Start-stop indicator.....	86
Warning Triangle.....	219
Washer Fluid Check.....	246
Waveband button.....	279
Wheels and Tyres.....	253
General Information.....	253
Technical Specifications.....	262
Windows and Mirrors.....	74
Windscreen Washers.....	51
Windscreen Wipers.....	50
Intermittent wipe.....	50
Wipers and Washers.....	50
Technical Specifications.....	53

