

Ford**Mondeo**
Owner's handbook

Feel the difference



The information contained in this publication was correct at the time of going to print. In the interest of development the right is reserved to change specifications, design or equipment at any time without notice and without incurring any obligations. This publication, or part thereof, may not be reproduced nor translated without our approval. Errors and omissions excepted.

© Ford Motor Company 2010

All rights reserved.

Part number: AS7J-19A321-DA (CG3536en) 03/2010 20100311080048



Table of contents

Introduction

About this handbook.....	7
Symbols glossary.....	7
Parts and accessories.....	7

Quick start

Quick start.....	10
------------------	----

Child safety

Child seats.....	18
Booster cushions.....	19
Child seat positioning.....	21
ISOFIX anchor points.....	23
Child safety locks.....	24

Occupant protection

Principle of operation.....	26
Fastening the seat belts.....	28
Seat belt height adjustment.....	29
Seat belt reminder.....	29
Using seat belts during pregnancy.....	29
Disabling the passenger airbag.....	29

Keys and remote controls

General information on radio frequencies.....	31
Programming the remote control.....	31
Changing the remote control battery.....	31

Locks

Locking and unlocking.....	35
Global opening and closing.....	37
Keyless entry.....	39

Engine immobiliser

Principle of operation.....	42
Coded keys.....	42
Arming the engine immobiliser.....	42
Disarming the engine immobiliser.....	42

Alarm

Principle of operation.....	43
Arming the alarm.....	45
Disarming the alarm.....	45

Steering wheel

Adjusting the steering wheel.....	46
Audio control.....	46

Wipers and washers

Windscreen wipers.....	48
Autowipers.....	48
Windscreen washers.....	49
Rear window wiper and washers.....	49
Headlamp washers.....	50
Checking the wiper blades.....	50
Changing the wiper blades.....	50

Lighting

Lighting control.....	52
Autolamps.....	53
Front fog lamps.....	53
Rear fog lamps.....	53
Adjusting the headlamps - Vehicles With: Adaptive Front Lighting/Xenon Headlamps.....	54
Headlamp levelling.....	54
Hazard warning flashers.....	55
Adaptive front lighting system (AFS).....	55
Direction indicators.....	57
Interior lamps.....	57
Removing a headlamp.....	58
Changing a bulb.....	59
Bulb specification chart.....	66

Windows and mirrors

Electric windows.....	68
Exterior mirrors.....	70
Electric exterior mirrors.....	70

Table of contents

Auto-dimming mirror.....	72
--------------------------	----

Instruments

Gauges.....	73
Warning lamps and indicators.....	75
Audible warnings and indicators.....	77

Information displays

General information.....	78
Trip computer.....	87
Personalised settings.....	89
Information messages.....	91

Climate control

Principle of operation.....	100
Air vents.....	100
Manual climate control.....	101
Automatic climate control.....	103
Heated windows and mirrors.....	105
Auxiliary heater.....	106
Electric sunroof.....	111

Seats

Sitting in the correct position.....	114
Manual seats.....	114
Electric seats.....	115
Head restraints.....	117
Rear seats.....	117
Heated seats.....	118
Ventilated seats.....	118

Convenience features

Sun blinds.....	120
Instrument lighting dimmer.....	120
Clock.....	120
Cigar lighter.....	120
Ashtray.....	121
Auxiliary power sockets.....	121
Cup holders.....	122

Glove box.....	122
Storage compartments.....	122
Map pockets.....	123
Memory function.....	123
Glasses holder.....	124
CD changer.....	124
Auxiliary input (AUX IN) socket.....	124
USB port.....	125
Floor mats.....	125

Starting the engine

General information.....	126
Ignition switch.....	126
Keyless starting.....	126
Steering wheel lock.....	128
Starting a petrol engine.....	128
Starting a petrol engine - E85.....	129
Starting a diesel engine.....	130
Diesel particulate filter (DPF).....	130
Switching off the engine.....	131
Engine heater.....	131

Fuel and refuelling

Fuel quality - Petrol.....	132
Fuel quality - E85.....	132
Fuel quality - Diesel.....	132
Catalytic converter.....	133
Fuel filler flap.....	133
Refuelling.....	134
Refuelling - E85.....	134
Fuel consumption.....	134
Technical specifications.....	134

Transmission

Manual transmission.....	138
Automatic transmission.....	138

Brakes

Principle of operation.....	141
-----------------------------	-----

Table of contents

Hints on driving with ABS.....	141	Luggage covers.....	163
Parking brake.....	141	Roof racks and load carriers.....	164
Stability control		Dog guard.....	164
Principle of operation.....	142	Load retaining fixtures.....	166
Using stability control.....	142		
Hill start assist		Towing	
Principle of operation.....	143	Towing a trailer.....	168
Using hill start assist.....	143	Detachable tow ball.....	168
Active suspension		Driving hints	
Principle of operation.....	146	Running-in.....	172
Using active suspension.....	146	General driving points - Vehicles With: Sports Suspension.....	172
		Cold weather precautions.....	172
		Driving through water.....	172
Parking aid		Emergency equipment	
Principle of operation.....	147	First aid kit.....	173
Using the parking aid.....	147	Warning triangle.....	173
Cruise control		Fuses	
Principle of operation.....	149	Fuse box locations.....	174
Using cruise control.....	149	Changing a fuse.....	176
Adaptive cruise control (ACC)		Fuse specification chart - Vehicles Built Up To: 07-02-2010.....	177
Principle of operation.....	151	Fuse specification chart - Vehicles Built From: 08-02-2010.....	186
Using ACC.....	152		
Forward alert function.....	155	Vehicle recovery	
Speed limiter		Towing points.....	196
Principle of operation.....	157	Towing the vehicle on four wheels.....	196
Using the speed limiter.....	157	Maintenance	
Load carrying		General information.....	198
General information.....	159	Opening and closing the bonnet.....	199
Luggage anchor points.....	159	Engine compartment overview - 1.6L Duratec-16V Ti-VCT (Sigma).....	200
Sliding loadspace floor.....	160	Engine compartment overview - 2.0L Duratec-HE (M14).....	201
Rear under floor storage.....	162	Engine compartment overview - 2.0L EcoBoost SCTi (M14).....	202
Cargo nets.....	162		

Table of contents

Engine compartment overview - 2.3L Duratec-HE (M14).....	203
Engine compartment overview - 2.5L Duratec (V15).....	204
Engine compartment overview - 1.8L Duratorq-TDCi (Lynx) Diesel.....	205
Engine compartment overview - 2.0L Duratorq-TDCi (DW) Diesel.....	206
Engine compartment overview - 2.2L Duratorq-TDCi (DW) Diesel.....	207
Engine oil dipstick - 1.6L Duratec-16V Ti-VCT (Sigma).....	208
Engine oil dipstick - 2.0L Duratec-HE (M14)/2.3L Duratec-HE (M14).....	208
Engine oil dipstick - 2.0L EcoBoost SCTi (M14).....	209
Engine oil dipstick - 2.5L Duratec (V15).....	209
Engine oil dipstick - 1.8L Duratorq-TDCi (Lynx) Diesel.....	209
Engine oil dipstick - 2.0L Duratorq-TDCi (DW)/2.2L Duratorq-TDCi (DW) Diesel.....	209
Engine oil check.....	210
Engine coolant check.....	210
Brake and clutch fluid check.....	211
Power steering fluid check.....	211
Washer fluid check.....	211
Technical specifications.....	212
Vehicle care	
Cleaning the exterior.....	215
Cleaning the interior.....	215
Repairing minor paint damage.....	216
Vehicle battery	
Using booster cables.....	217
Battery connection points.....	218
Wheels and tyres	
General information.....	219
Changing a road wheel.....	219
Run flat tyres.....	224
Tyre repair kit.....	225
Tyre care.....	229
Using winter tyres.....	229
Using snow chains.....	229
Tyre pressure monitoring system.....	229
Technical specifications.....	231
Vehicle identification	
Vehicle identification plate.....	234
Vehicle identification number (VIN).....	234
Technical specifications	
Technical specifications.....	235
Telephone	
General information.....	243
Telephone setup.....	243
Bluetooth setup.....	244
Telephone controls.....	245
Using the telephone - Vehicles Without: Navigation System.....	245
Using the telephone - Vehicles With: Navigation System.....	248
Voice control	
Principle of operation.....	250
Using voice control.....	250
Audio unit commands.....	251
Telephone commands.....	260
Navigation system commands.....	265
Climate control commands.....	265
Connectivity	
General information.....	268
Connecting an external device.....	269
Connecting an external device - Vehicles With: Bluetooth.....	269
Using a USB device.....	270
Using an iPod.....	272

Table of contents

Navigation introduction

Road Safety.....276

Navigation system

Getting started.....277

Appendices

Type approvals.....279

Type approvals.....279

Type approvals.....279

Electromagnetic compatibility.....280

Introduction

ABOUT THIS HANDBOOK

Thank you for choosing Ford. We recommend that you take some time to get to know your vehicle by reading this handbook. The more that you know about it, the greater the safety and pleasure you will get from driving it.

Note: *This handbook describes product features and options available throughout the range, sometimes even before they are generally available. It may describe options not fitted to your vehicle.*

Note: *Some of the illustrations in this handbook may be used for different models, so may appear different to your vehicle. However, the essential information in the illustrations is always correct.*

Note: *Always use and operate your vehicle in line with all applicable laws and regulations.*

Note: *Pass on this handbook when selling your vehicle. It is an integral part of the vehicle.*

This vehicle has received the endorsement of TÜV, the accredited international testing organisation, for its allergy-friendly properties.

All materials used in the manufacture of the interior of this vehicle meet strict requirements of the TÜV TOXPROOF Criteria Catalogue for Vehicle Interiors by TÜV Produkt und Umwelt GmbH and are designed to minimize the risk of allergic reactions.

Additionally an efficient pollen filter protects the passengers against allergen particles in the outdoor air.

For more information, contact TÜV at www.tuv.com.

SYMBOLS GLOSSARY

Symbols in this handbook

WARNING



You risk death or serious injury to yourself and others if you do not follow the instructions highlighted by the warning symbol.

CAUTION



You risk damaging your vehicle if you do not follow the instructions highlighted by the caution symbol.

Symbols on your vehicle



When you see these symbols, read and follow the relevant instructions in this handbook before touching or attempting adjustment of any kind.

PARTS AND ACCESSORIES

Now you can be sure that your Ford parts are Ford parts

Your Ford has been built to the highest standards using high quality Ford Original Parts. As a result, you can enjoy driving it for many years.

Should the unexpected occur and a major part needs replacing, we recommend that you accept nothing less than Ford Original Parts.

Introduction

The use of Ford Original Parts ensures that your vehicle is repaired to its pre-accident condition and maintains its maximum residual value.

Ford Original Parts match Ford's stringent safety requirements and high standards of fit, finish and reliability. Quite simply, they represent the best overall repair value, including parts and labour costs.

Now it is easier to tell if you have really been given Ford Original Parts. The Ford logo is clearly visible on the following parts if they are Ford Original Parts. If your vehicle has to be repaired, look for the clearly visible Ford branding and make sure that only Ford Original Parts have been used.

Look for the Ford logo on the following parts

Sheet metal

- Bonnet
- Doors
- Luggage compartment lid or tailgate

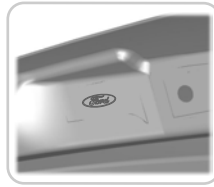

E88678

Bumper and radiator grille

- Radiator grille
- Front and rear bumper

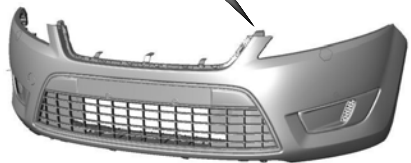
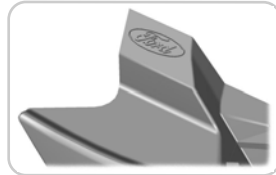

E88505

Introduction

Exterior mirror

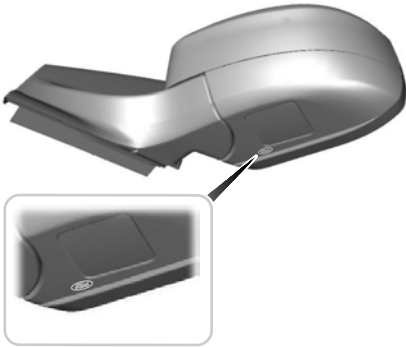

E88506



E88508

Glass

- Rear window
- Side glass
- Windscreen

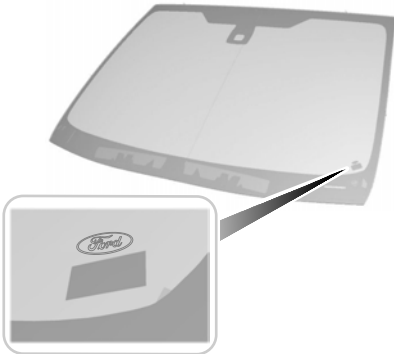

E88507

Lighting

- Rear lamps
- Headlamp

Quick start

QUICK START

Instrument panel overview - left-hand drive

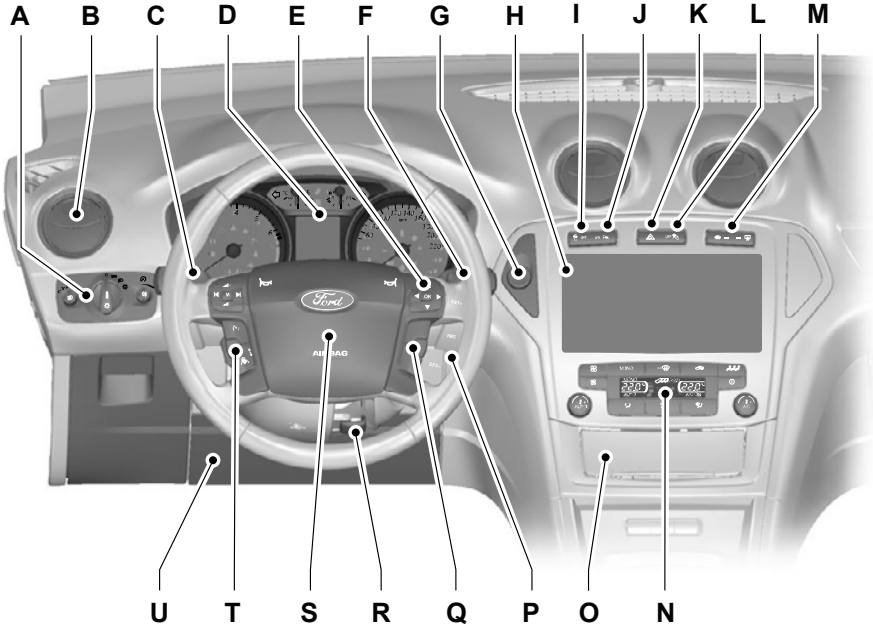

E87719

Quick start

Instrument panel overview - right-hand drive

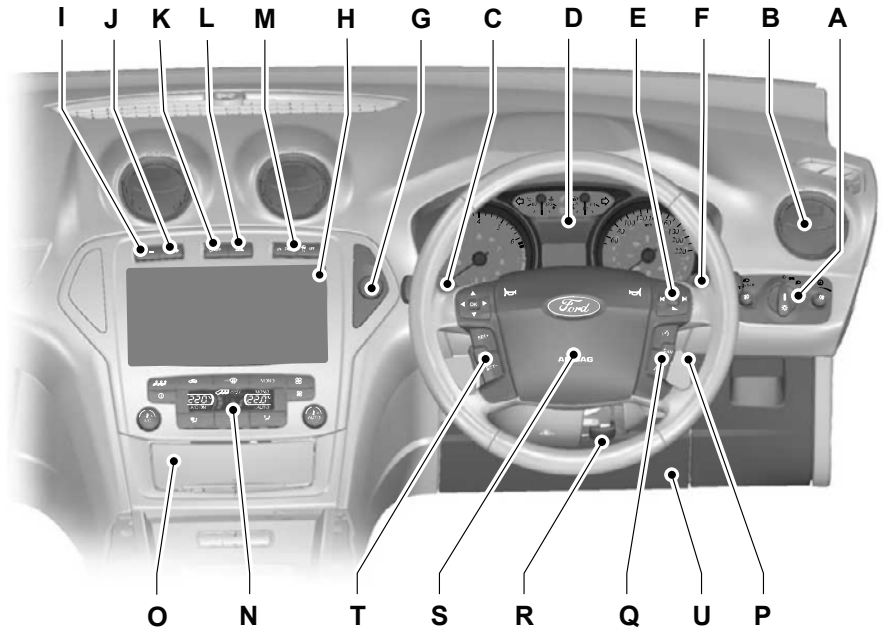

E87720

- A Lighting controls. See **Lighting control** (page 52).
- B Air vents. See **Air vents** (page 100).
- C Direction indicators. See **Direction indicators** (page 57). Telephone control buttons. See **Telephone controls** (page 245). Voice control buttons. See **Using voice control** (page 250).
- D Instrument cluster. See **Gauges** (page 73).
- E Information display controls. See **Information displays** (page 78).
- F Wiper lever. See **Windscreen wipers** (page 48).
- G Start Button. See **Keyless starting** (page 126).
- H Audio or navigation unit. See separate handbook.
- I Stability control (ESP) switch. See **Using stability control** (page 142).

Quick start

- J Parking aid switch. See **Using the parking aid** (page 147).
- K Hazard warning flasher switch. See **Hazard warning flashers** (page 55).
- L Passenger airbag deactivation warning lamp. See **Disabling the passenger airbag** (page 29).
- M Heated windshield and heated rear window switches. See **Heated windows and mirrors** (page 105).
- N Climate controls. See **Manual climate control** (page 101). See **Automatic climate control** (page 103).
- O Cigar lighter. See **Cigar lighter** (page 120).
- P Ignition switch. See **Ignition switch** (page 126).
- Q Cruise control and speed limiter switches. See **Using cruise control** (page 149). Adaptive cruise control switches. See **Using ACC** (page 152). Speed limiter switches. See **Using the speed limiter** (page 157).
- R Steering wheel adjustment lever. See **Adjusting the steering wheel** (page 46).
- S Horn.
- T Cruise control and speed limiter switches. See **Using cruise control** (page 149). Adaptive cruise control switches. See **Using ACC** (page 152). Speed limiter switches. See **Using the speed limiter** (page 157).
- U Driver Knee airbag. See **Principle of operation** (page 26).

Keyless entry

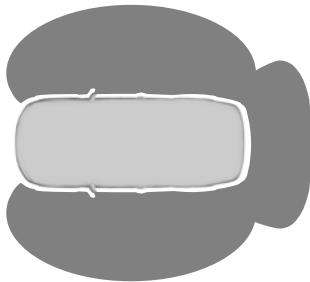

E78276

Passive locking and unlocking requires a valid passive key to be located within one of the three external detection ranges.

Unlocking the vehicle

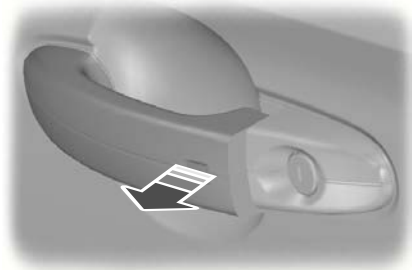

E78278

Pull a door handle to unlock all the doors and the luggage compartment lid and disarm the alarm.

Quick start

Locking the vehicle

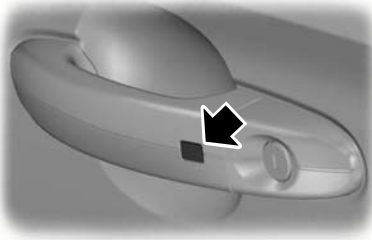

E87384



E87435

See **Keyless entry** (page 39).

Adjusting the steering wheel

WARNING



Never adjust the steering wheel when the vehicle is moving.

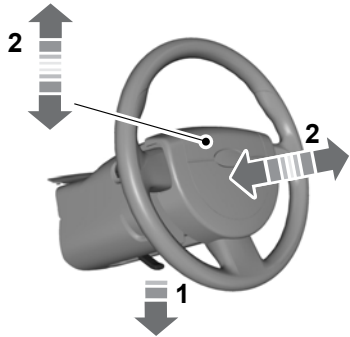

E95178



E95179

See **Adjusting the steering wheel** (page 46).

Quick start

Autowipers

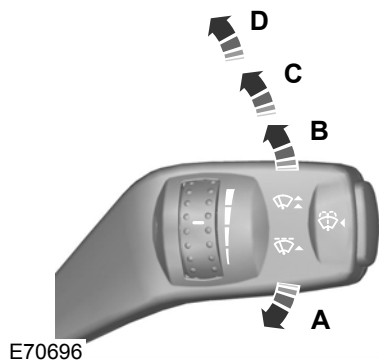

- A Single wipe
- B Autowipers
- C Normal wipe
- D High speed wipe

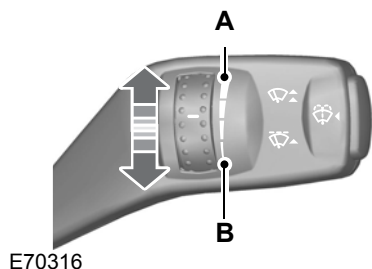

- A High sensitivity
- B Low sensitivity

See **Autowipers** (page 48).

Autolamps

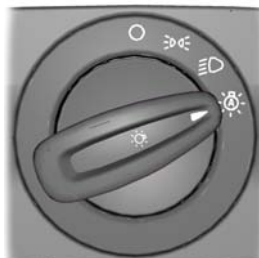

E70719

The headlamps will come on and go off automatically depending on the ambient light.

See **Lighting control** (page 52).

Electric folding mirrors



E72623

See **Electric exterior mirrors** (page 70).

Quick start

Information displays



E70499

Use the arrow buttons to navigate through the menus and press **OK** to make a selection.

See **Information displays** (page 78).

Manual climate control

Heating the interior quickly



E71377

Cooling the interior quickly

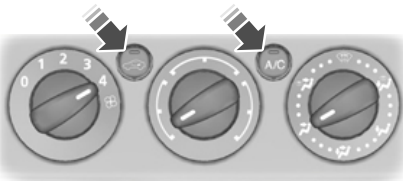

E71381

Defrosting and demisting the windscreen

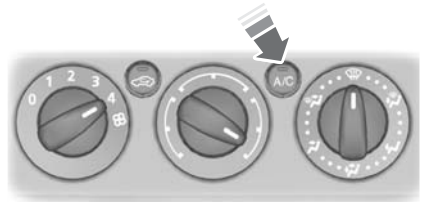

E71382

See **Manual climate control** (page 101).

Automatic climate control



E70304

See **Automatic climate control** (page 103).

Engine idle speed after starting

The engine may idle at a higher speed than normal immediately after starting from cold.

See **Starting the engine** (page 126).

Quick start

Keyless starting



E85766

Press the start button.

See **Keyless starting** (page 126).

Diesel particulate filter (DPF)

WARNING



Do not park or idle your vehicle over dry leaves, dry grass or other combustible materials. The DPF regeneration process creates very high exhaust gas temperatures and the exhaust will radiate a considerable amount of heat during and after DPF regeneration, and after you have switched the engine off. This is a potential fire hazard.

See **Diesel particulate filter (DPF)** (page 130).

Fuel filler flap

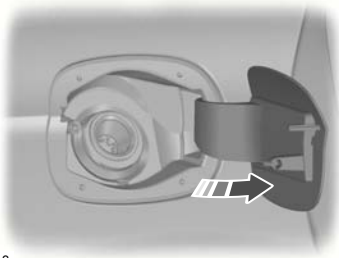

E86613

Press the flap to open it. Open the flap fully until it engages.

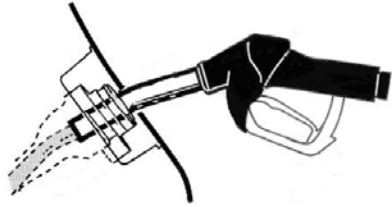

E119080

Insert the fuel nozzle up to and including the first notch on the nozzle. Keep it resting on the cover of the fuel pipe opening.

WARNING



We recommend that you wait at least 10 seconds before removing the fuel nozzle to allow any residual fuel to drain into the fuel tank.

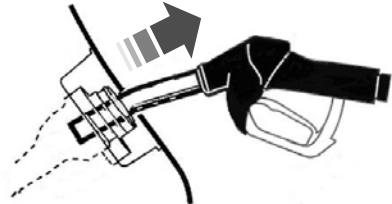

E119081

Slightly raise the fuel nozzle to remove it.

See **Fuel filler flap** (page 133).

Quick start

Manual transmission

Selecting reverse gear

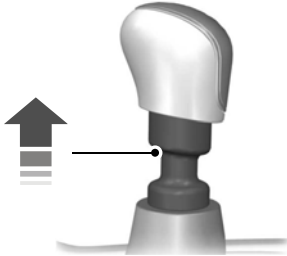

E99067

On some vehicles it is necessary to raise the collar whilst selecting reverse gear.

See **Manual transmission** (page 138).

Automatic transmission

Note: Do not press the brake pedal when removing the key from the ignition switch.

Selector lever positions

WARNING



Apply the brakes before moving the selector lever and keep them applied until you are ready to move off.



E80836

- P Park
- R Reverse
- N Neutral
- D Drive
- S Manual shifting and sport mode

See **Automatic transmission** (page 138).

Speed limiter

The system allows you to set a speed, to which the vehicle then becomes limited.

See **Speed limiter** (page 157).

Towing the vehicle on four wheels

CAUTION



For certain engine and transmission combinations, it is recommended not to tow the vehicle with the drive wheels on the ground.

See **Towing the vehicle on four wheels** (page 196).







Child safety

CHILD SEATS



E68916

WARNINGS

-  Secure children that are less than 150 centimetres tall or less than 12 years of age in a suitable, approved child restraint, in the rear seat.
-  Original text according to ECE R94.01: Extreme Hazard! Do not use a rearward facing child restraint on a seat protected by an air bag in front of it!
-  Read and follow the manufacturer's instructions when you are fitting a child restraint.
-  Do not modify child restraints in any way.
-  Do not hold a child on your lap when the vehicle is moving.
-  Do not leave unattended children in your vehicle.
-  If your vehicle has been involved in an accident, have the child restraints checked by properly trained technicians.

Note: *Mandatory use of child restraints varies from country to country.*

Only child restraints certified to ECE-R44.03 (or later) have been tested and approved for use in your vehicle. A choice of these are available from your Dealer.

Child restraints for different mass groups

Use the correct child restraint as follows:

Baby safety seat



E68918

Secure children that weigh less than 13 kilograms in a rearward facing baby safety seat (Group 0+) in the rear seat.

Child safety

Child safety seat



E68920

Secure children that weigh between 13 and 18 kilograms in a child safety seat (Group 1) in the rear seat.

Booster seat









E70710

We recommend that you use a booster seat that combines a cushion with a backrest instead of a booster cushion only. The raised seating position will allow you to position the shoulder strap of the adult seat belt over the centre of your child's shoulder and the lap strap tightly across its hips.

BOOSTER CUSHIONS

WARNINGS

-  Do not install a booster seat or a booster cushion with only the lap strap of the seat belt.
-  Do not install a booster seat or a booster cushion with a seat belt that is slack or twisted.
-  Do not put the seat belt under your child's arm or behind its back.
-  Do not use pillows, books or towels to boost your child's height.
-  Make sure that your children sit in an upright position.
-  Secure children that weigh more than 15 kilogrammes but are less than 150 centimetres tall in a booster seat or a booster cushion.

Booster cushion





E68924

Child safety

Integrated booster cushion

WARNINGS

-  Do not use the raised integrated booster cushion together with a child safety seat.
-  The integrated booster cushion can be used for children that weigh between 22 and 36 kilogrammes (49 and 79 pounds).

CAUTION

-  Remove the rear seat head restraint unless the child's head exceeds the top of the backrest. See **Head restraints** (page 117).

Unlocking

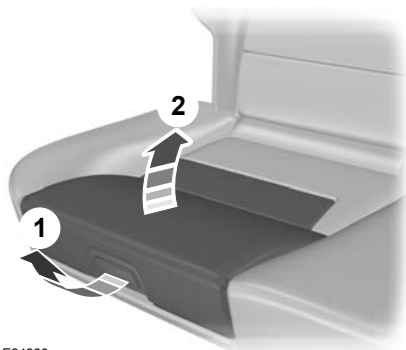

E94860

Note: Make sure that the locking mechanism is fully engaged.

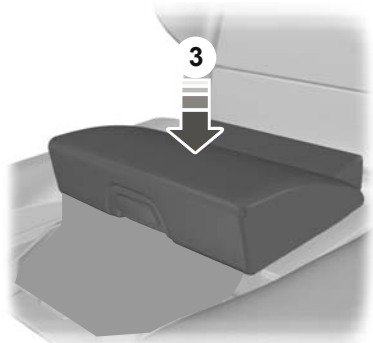

E94861

The raised seating position will allow you to position the shoulder strap of the adult seat belt over the centre of your child's shoulder and the lap strap tightly across its hips.

Locking

Note: Make sure that there are no obstructions in the linkage area before locking the integrated booster cushion.

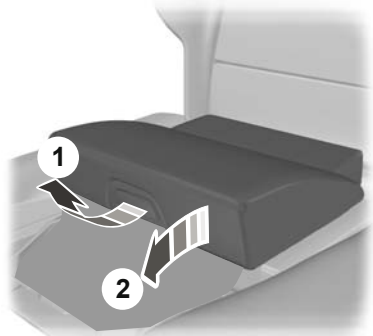

E94862

Note: Make sure that the locking mechanism is fully engaged.

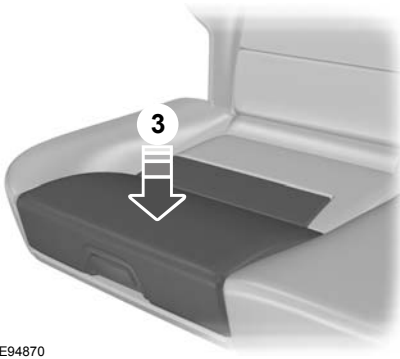

Child safety



E94870

CHILD SEAT POSITIONING

WARNINGS

-  When using a child restraint with a support leg on a second row seat, make sure the support leg rests securely on the floor.
-  When using a forward facing child seat on a second row seat, always remove the head restraint from that seat.
-  When fitting a child seat using the vehicle seat belts make sure the belts are not slack.

Note: When using a child restraint on a front seat, it may prove difficult to tighten the lap section of the seat belt without slack remaining. If this is the case, adjust the seatback to the fully upright position and raise the height of the seat. See **Seats** (page 114).

Seating positions	Mass group categories				
	0	0+	I	II	III
	Up to 10 kg	Up to 13 kg	9 - 18 kg	15 - 25 kg	22 - 36 kg
Front passenger seat with airbag ON	X	X	UF ¹	UF ¹	UF ¹
Front passenger seat with airbag OFF	U ¹	U ¹	U ¹	U ¹	U ¹
Rear seats	U	U	U	U	U

X Not suitable for children in this mass group.

U Suitable for universal category child restraints approved for use in this mass group.

U¹ Suitable for universal category child restraints approved for use in this mass group. However, we recommend that you secure children in a government approved child restraint, in the rear seat.

UF¹ Suitable for universal category forward facing child restraints approved for use in this mass group. However, we recommend that you secure children in a government approved child restraint, in the rear seat.

Child safety

ISOFIX child restraints

Seating positions	Mass group categories		
	0	0+	I
	Up to 10 kg	Up to 13 kg	9 - 18 kg
Rear seat ISOFIX restraints	IL	IL	IL, IUF**
Rear seat ISOFIX classes*	E	C, D, E	A, B, B1, C, D

IUF Suitable for universal category ISOFIX child restraints approved for use in this mass group.

IL Suitable for the following ISOFIX child restraints: Roemer Duo ISOFIX (group **1**), Roemer Babysafe ISOFIX (group **0+**). In addition, any semi-universal ISOFIX child restraint may be used if indicated in the child seat manufacturers vehicle list.

* As defined by ECE-R16.

Note: ** When you are purchasing an ISOFIX restraint, make sure that you know the correct mass group and ISOFIX size class for the intended seating locations.

Note: ** Make sure that the top tether mechanism does not interfere with the luggage cover.

Child safety

ISOFIX ANCHOR POINTS

WARNING

 Use an anti-rotation device when using the ISOFIX system. We recommend the use of a top tether or support leg.

Your vehicle is fitted with ISOFIX anchor points that accommodate universally approved ISOFIX child restraints.

The ISOFIX system comprises two rigid attachment arms on the child restraint that attach to anchor points on the outboard rear seats, where the cushion and backrest meet. Tether anchor points are fitted behind the outboard rear seats for child restraints with a top tether.

Top tether anchor points



E87146

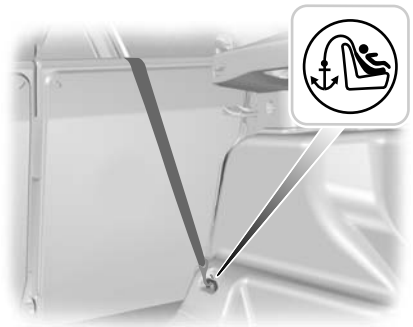

E93616



E93514

Attaching a child seat with top tethers

WARNING

 Do not attach a tether strap to anything other than the correct tether anchor point.

Note: Where applicable, remove the luggage cover to ease installation. See **Luggage covers** (page 163).

Note: On 4-door vehicles, make sure the tether strap tightening mechanism remains accessible when the seatback is fully engaged.

Child safety

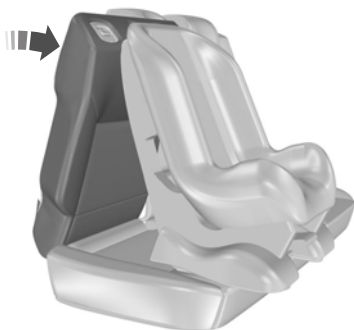

E87591

1. Place the child seat on the back seat cushion and fold the relevant seatback forwards. See **Rear seats** (page 117).
2. Remove the head restraint. See **Head restraints** (page 117).

WARNING



Make sure the top tether strap is not slack or twisted and is properly located on the anchor point.

3. Route the tether strap to the anchor point.

WARNING



Make sure that the seatback is secure and fully engaged in the catch.

4. Push the seatback to the upright position.



E87145

5. Push the child seat back firmly to engage the ISOFIX lower anchor points.
6. Tighten the tether strap in line with the child seat manufacturer's instructions.

CHILD SAFETY LOCKS

WARNING



You cannot open the doors from inside if you have put the child safety locks on.

Note: On vehicles with keyless entry, use the spare key. See **Keyless entry** (page 39).

Child safety



E78298

Left-hand side

Turn anti-clockwise to lock and clockwise to unlock.

Right-hand side

Turn clockwise to lock and anti-clockwise to unlock.

Occupant protection

PRINCIPLE OF OPERATION

Airbags

WARNINGS



Do not modify the front of your vehicle in any way. This could adversely affect deployment of the airbags.



Original text according to ECE R94.01: Extreme Hazard! Do not use a rearward facing child restraint on a seat protected by an airbag in front of it!



Wear a seat belt and keep sufficient distance between yourself and the steering wheel. Only when you use the seat belt properly, can it hold you in a position that allows the airbag to achieve its optimum effect. See **Sitting in the correct position** (page 114).



Have repairs to the steering wheel, steering column, seats, airbags and seat belts carried out by a properly trained technician.



Keep the areas in front of the airbags free from obstruction. Do not affix anything to or over the airbag covers.



Do not poke sharp objects into areas where airbags are fitted. This could damage and adversely affect deployment of the airbags.



Use seat covers designed for seats with side airbags. Have these fitted by a properly trained technician.

Note: You will hear a loud bang and see a cloud of harmless powdery residue if an airbag deploys. This is normal.

Note: Only wipe airbag covers with a damp cloth.

Driver and front passenger airbags

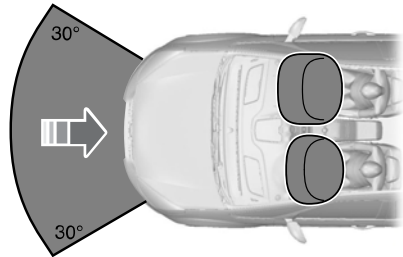

E74302

The driver and front passenger airbags will deploy during significant frontal collisions or collisions that are up to 30 degrees from the left or the right. The airbags will inflate within a few thousandths of a second and deflate on contact with the occupants, thus cushioning forward body movement. During minor frontal collisions, overturns, rear collisions and side collisions, the driver and front passenger airbags will not deploy.

Driver knee airbag

CAUTION



Do not attempt to open the driver knee airbag cover.

The driver knee airbag will deploy during frontal collisions or collisions that are up to 30 degrees from the left or the right. The airbag will inflate within a few thousandths of a second and deflate on contact with the occupants, thus providing a cushion between the driver's knees and the steering column. During overturns, rear collisions and side collisions, the knee airbag will not deploy.

For item location: See **Quick start** (page 10).

Occupant protection

Note: The knee airbag has a lower deployment threshold than the front airbags. During a minor collision, it is possible that only the knee airbag deploys.

Side airbags



E72658

Side airbags are fitted inside the seatback of the front seats. A label indicates that side airbags are fitted to your vehicle.

The side airbags will deploy during significant lateral collisions. The airbags will inflate within a few thousandths of a second and deflate on contact with the occupants, thus providing protection for the chest and shoulder areas. During minor lateral collisions, overturns, front collisions and rear collisions, the side airbags will not deploy.

Curtain airbags

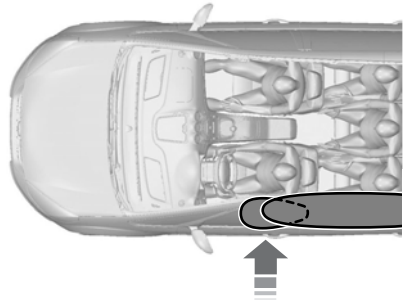

E75004

Curtain airbags are fitted inside the trim panels over the front and rear side windows. Moulded badges in the B-pillar trim panels indicate that curtain airbags are fitted to your vehicle.

The curtain airbags will deploy during significant lateral collisions. The airbag will inflate within a few thousandths of a second and deflate on contact with the occupants, thus providing protection for the head. During minor lateral collisions, front collisions, rear collisions, or overturns the curtain airbags will not deploy.

Seat belts

WARNINGS

 Wear a seat belt and keep sufficient distance between yourself and the steering wheel. Only when you use the seat belt properly, can it hold you in a position to achieve its optimum effect. See **Sitting in the correct position** (page 114).

 Never use a seat belt for more than one person.

 Use the correct buckle for each seat belt.

Occupant protection

WARNINGS



Do not use a seat belt that is slack or twisted.



Do not wear thick clothing. The seat belt must fit tightly around your body to achieve its optimum effect.



Position the shoulder strap of the seat belt over the centre of your shoulder and position the lap strap tightly across your hips.

The driver and front passenger seat belt retractors are fitted with a seat belt pretensioner. Seat belt pretensioners have a lower deployment threshold than the airbags. During minor collisions, it is possible that only the seat belt pretensioners will deploy.

Status after a collision

WARNING



Seat belts subjected to strain, as a result of an accident, should be renewed and the anchorages checked by a properly trained technician.

FASTENING THE SEAT BELTS

WARNING



Insert the tongue into the buckle until you hear a distinct click. You have not fastened the seat belt properly if you do not hear a click.



E74124

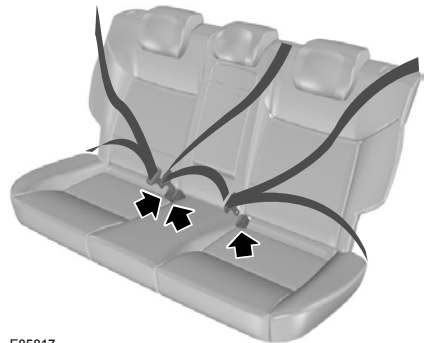

E85817

Pull the belt out steadily. It may lock if you pull it sharply or if the vehicle is on a slope.

Press the red button on the buckle to release the belt. Let it retract completely and smoothly.

Occupant protection

SEAT BELT HEIGHT ADJUSTMENT



E87511

Note: *Lifting the slider slightly while pressing the locking button makes it easier to release the locking mechanism.*

To raise or lower, press the locking button on the adjuster and move as necessary.

SEAT BELT REMINDER

WARNING



The occupant protection system will only provide optimum protection when you use the seat belt properly.



The seat belt reminder warning lamp illuminates and an audible warning will sound if the driver's or front seat passenger's seat belt has not been fastened and the vehicle exceeds a relatively low speed. It will also illuminate if the driver's or front seat passenger's seat belt is unfastened when the vehicle is moving. The audible warning and warning lamp will go off after seven minutes.

Deactivating the seat belt reminder

See your dealer.

USING SEAT BELTS DURING PREGNANCY

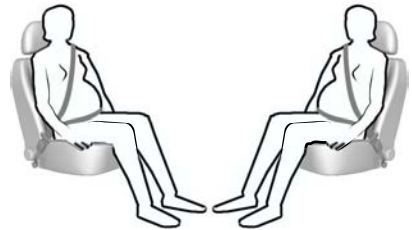

E68587

WARNING



Position the seat belt correctly for your safety and that of your unborn child. Do not use only the lap strap or the shoulder strap.

Position the lap strap comfortably across your hips and low beneath your pregnant abdomen. Position the shoulder strap between your breasts, above and to the side of your pregnant abdomen.

DISABLING THE PASSENGER AIRBAG

WARNING



Make sure that the passenger airbag is disabled when using a rearward facing child restraint on the front passenger seat.

Occupant protection



E71313

Fitting the passenger airbag deactivation switch

WARNING

 If you need to fit a child restraint on a seat protected by an operational airbag in front of it, have a passenger airbag deactivation switch fitted. Ask your dealer for further information.

Note: *The key switch is located in the glove compartment with an airbag deactivation lamp in the instrument panel.*

If the airbag warning lamp illuminates or flashes when you are driving, this indicates a malfunction. See **Warning lamps and indicators** (page 75). Remove the child restraint and have the system checked immediately.

Disabling the passenger airbag

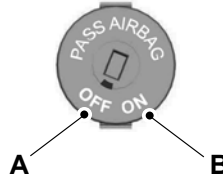

E71312

A Disabled

B Enabled

Turn the switch to position **A**.

When you switch the ignition on, check that the passenger airbag deactivation warning lamp illuminates.

Enabling the passenger airbag

WARNING

 Make sure that the passenger airbag is enabled when you are **not** using a child restraint on the front passenger seat.

Turn the switch to position **B**.

Keys and remote controls

GENERAL INFORMATION ON RADIO FREQUENCIES

CAUTION

! The radio frequency used by your remote control can also be used by other short distance radio transmissions (e.g. amateur radios, medical equipment, wireless headphones, remote controls and alarm systems). If the frequencies are jammed, you will not be able to use your remote control. You can lock and unlock the doors with the key.

Note: You could unlock the doors if you press the buttons on the remote control unintentionally.

The operating range between your remote control and your vehicle varies depending on the environment.

PROGRAMMING THE REMOTE CONTROL

You can programme a maximum of eight remote controls to use with your vehicle (including any supplied with your vehicle).

Programming a new remote control

1. Insert the key in the ignition.
2. Cycle the key from position **0** to **II** and then back to **0** four times in quick succession (about once a second).
3. Remove the key from the ignition and press any button on the remote control.
4. Reinsert the key and turn to position **II** then **0**. Remove the key and test the remote control to confirm programming has been successful.

Reprogramming the unlocking function

Note: When you press the unlock button either all the doors are unlocked or only the driver's door is unlocked. Pressing the unlock button again unlocks all the doors.

Press and hold the unlock and lock buttons on the remote key simultaneously for at least four seconds with the ignition off. The direction indicators will flash twice to confirm the change.

To return to the original unlocking function, repeat the process.

CHANGING THE REMOTE CONTROL BATTERY



Make sure that you dispose of old batteries in an environmentally friendly way.

Seek advice from your local authority regarding recycling.

Remote control with a folding key blade

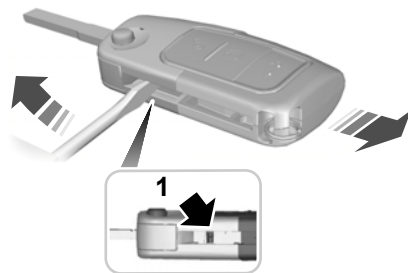

E74383

1. Insert a screwdriver as far as possible into the slot on the side of the remote control, push it towards the key blade and remove the key blade.

Keys and remote controls

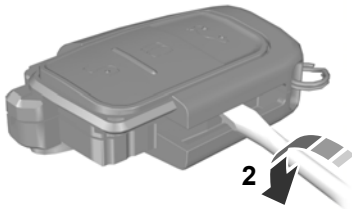

E74384

2. Twist the screwdriver in the position shown to start separating the two halves of the remote control.

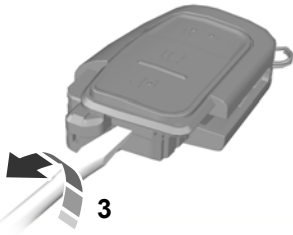

E74385

3. Twist the screwdriver in the position shown to separate the two halves of the remote control.

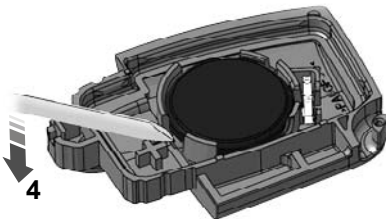

E126280

CAUTION

- ! Do not touch the battery contacts or the printed circuit board with the screwdriver.

4. Carefully prise out the battery with the screwdriver.
5. Install a new battery (3V CR 2032) with the + facing downwards.
6. Assemble the two halves of the remote control.
7. Install the key blade.

Remote control without a folding key blade

Type 1

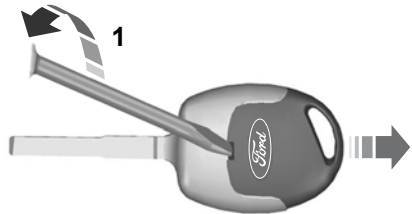

E126152

1. Insert a screwdriver into the recess on the back of the key and remove the key blade.

Keys and remote controls

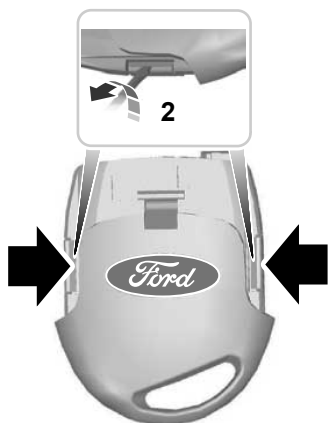

E126153

2. Release the retaining clips with the screwdriver and separate the two halves of the remote control.

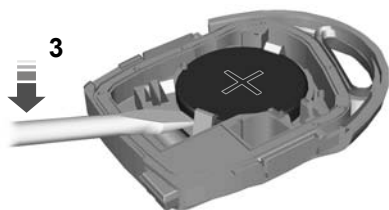

E126281

CAUTION

- ⚠ Do not touch the battery contacts or the printed circuit board with the screwdriver.

3. Carefully prise out the battery with the screwdriver.
4. Install a new battery (3V CR 2032) with the + facing upwards.
5. Assemble the two halves of the remote control.

6. Install the key blade.

Type 2

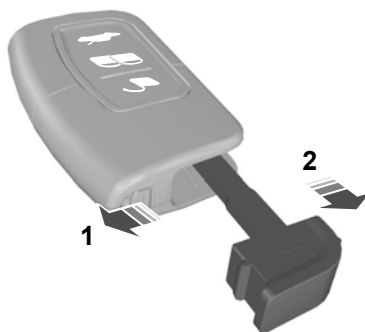

E78284

1. Slide the release slider in the direction of the arrow.
2. Remove the key blade.



E105064

3. Twist a flat bladed screwdriver in the position shown to separate the two halves of the remote control.

CAUTION

- ⚠ Do not touch the battery contacts or the printed circuit board with the screwdriver.

4. Carefully prise out the battery with the screwdriver.

Keys and remote controls

5. Install a new battery (3V CR 2032) with the + facing downwards.
6. Assemble the two halves of the remote control.
7. Install the key blade.

Type 3



E87964

1. Press and hold the pushbuttons on the edges to release the cover. Carefully remove the cover.
2. Remove the key blade.

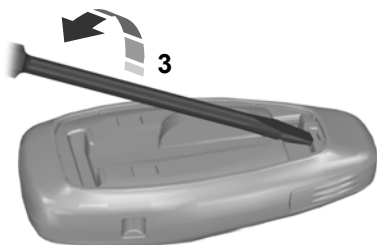

E105362

3. Twist a flat bladed screwdriver in the position shown to separate the two halves of the remote control.



E119190

4. Carefully insert the screwdriver in the position shown to open the remote control.

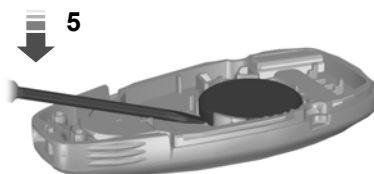

E125860

CAUTION

- ⚠ Do not touch the battery contacts or the printed circuit board with the screwdriver.

5. Carefully prise out the battery with the screwdriver.
6. Install a new battery (3V CR 2032) with the + facing downwards.
7. Assemble the two halves of the remote control.
8. Install the key blade.

Locks

LOCKING AND UNLOCKING

Central locking

You can only centrally lock the doors if they are all closed.

Note: *The driver's door can be unlocked with the key. This needs to be used if the remote control or keyless entry is not functioning.*

Note: *Central locking also locks and unlocks the fuel filler flap.*

Double locking

WARNING



Do not activate double locking when persons or animals are inside the vehicle. You will not be able to unlock the doors from the inside if you have double locked them.



E71961

Double locking is a theft protection feature that prevents someone from opening the doors from the inside. You can only double lock the doors if they are all closed.

Locking and unlocking confirmation

When you unlock the doors, the direction indicators will flash once.

When you lock the doors, the direction indicators will flash twice.

Note: *If your vehicle has double locking, the direction indicators will only flash twice once you have activated double locking.*

Locking and unlocking the doors with the key

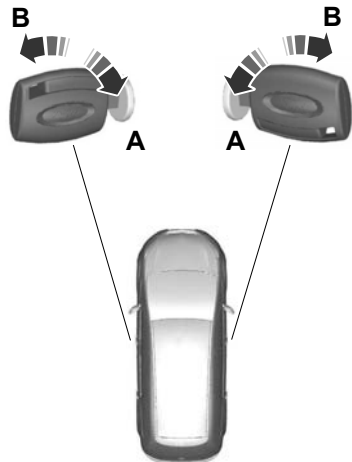

E71962

A Unlock

B Lock

Double locking the doors with the key

Turn the key to the lock position twice within three seconds to double lock the doors.

Locks

Locking and unlocking the doors and the luggage compartment lid with the remote control

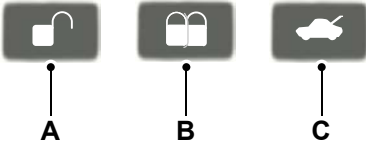

E87379

- A Unlock
- B Lock
- C Luggage compartment lid unlock

Locking the doors and the luggage compartment lid with the remote control

Press button **B** once.

Double locking the doors and the luggage compartment lid with the remote control

Press button **B** twice within three seconds.

Locking and unlocking the doors from inside

Driver's door

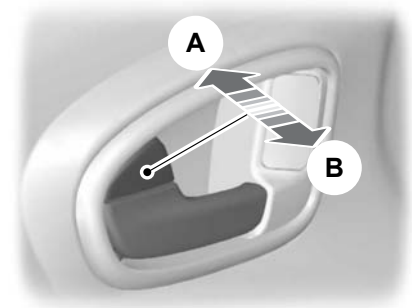

E71958

- A Lock all doors
- B Unlock all doors

Front and rear passenger doors



E98653

To lock the front and rear passenger doors individually, press the button and close the door when leaving the vehicle.

Locks

Luggage compartment lid

Opening the luggage compartment lid with the remote control

Press button **C** on the remote control twice within three seconds.

Closing the luggage compartment lid

4-door

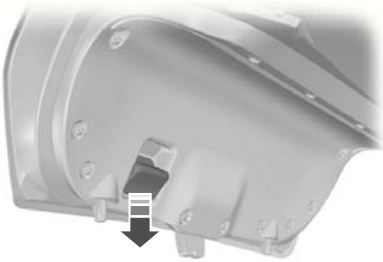

E89131

5-door



E89132

Estate



E89133

A recessed grip is incorporated inside the luggage compartment lid to facilitate closing.

Automatic relocking

The doors will relock automatically if you do not open a door within 45 seconds of unlocking the doors with the remote control. The door locks and the alarm will return to their previous state.

Reprogramming the unlocking function

The unlocking function may be reprogrammed so that only the driver's door is unlocked. See **Programming the remote control** (page 31).

GLOBAL OPENING AND CLOSING

You can also operate the electric windows with the ignition off via the global opening and global closing function.

Note: *Global closing will only operate if you have set the memory correctly for each window. See **Electric windows** (page 68).*

Locks

Global opening

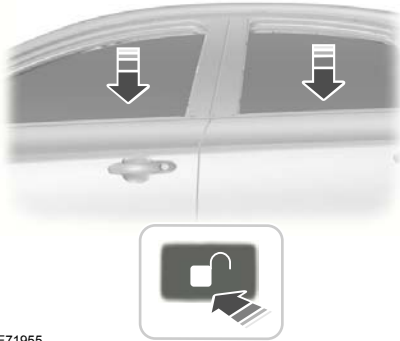

E71955

To open all the windows, press and hold the **unlock** button for at least three seconds. Press either the **lock** or the **unlock** button again to stop the opening function.

Global closing

Vehicles without keyless entry

WARNING



Take care when using global closing. In an emergency, press a button immediately to stop.

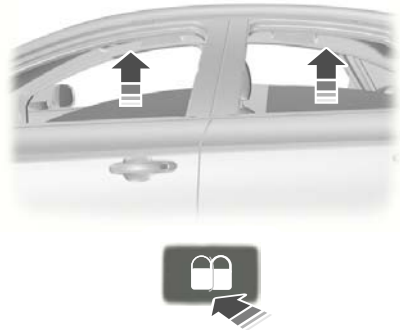

E71956

To close all the windows, press and hold the **lock** button for at least three seconds. Press any button again to stop the closing function. The anti-trap function is also active during global closing.

Vehicles with keyless entry

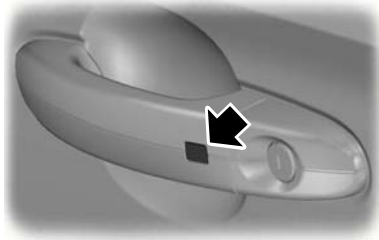

E87384

WARNING



Take care when using global closing. In an emergency, press the button on the driver's door handle to stop.

Note: *Global closing can be activated using the button on the driver's door handle. Global opening and closing can also be activated using the buttons on the passive key.*

To close all the windows, press and hold the button on the driver's door handle for at least two seconds. The anti-trap function is also active during global closing.

Locks

KEYLESS ENTRY

General information

WARNING



The keyless entry system may not function if the key is close to metal objects or electronic devices such as mobile phones.

Note: *If the door handles are pulled repeatedly during a short period of time without the presence of a valid passive key, the system will become inoperable for 30 seconds.*

The passive entry system will not function if:

- The passive key frequencies are jammed.
- The passive key battery is flat.

Note: *If the passive entry system does not function, you will need to use the key blade to lock and unlock your vehicle.*

The keyless system allows the driver to operate the vehicle without the use of a key or remote control.

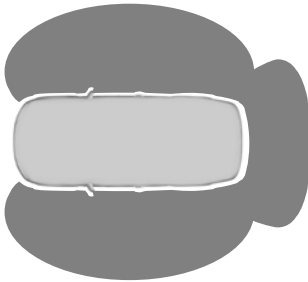

E78276

Passive locking and unlocking requires a valid passive key to be located within one of the three external detection ranges. These are located approximately one and a half metres from the driver and front passenger door handles and the luggage compartment lid.

Passive key

The vehicle can be locked and unlocked with the passive key. The passive key can also be used as a remote control. See **Locking and unlocking** (page 35).

Locking the vehicle

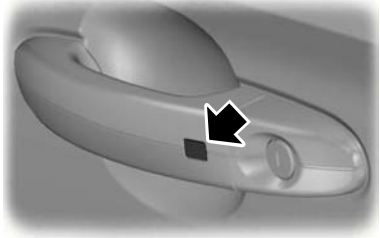

E87384



E87435

WARNING



The vehicle does not lock itself automatically. If no locking button is pressed, the vehicle will remain unlocked.

Locks

Note: If locking from the luggage compartment lid, the passive key must be within the luggage compartment lid detection range.

Locking buttons are located on each of the front doors and the luggage compartment lid.

To activate central locking and arm the alarm:

- Press a locking button once.

To activate double locking, to arm the alarm and the interior sensors:

- Press a locking button twice within three seconds.

Note: Once activated, the vehicle will remain locked for approximately three seconds. This is to allow you to pull a door handle and check if the vehicle is locked. When the delay period is over, the doors can be opened again, provided the passive key is within the respective detection range.

Luggage compartment lid

Note: The luggage compartment lid cannot be closed and will pop back up if the passive key is located inside the luggage compartment.

Note: If a second valid passive key is located within the luggage compartment lid detection range, the luggage compartment lid can be closed.

Unlocking the vehicle

Note: If the vehicle remains locked for longer than five days, the system will enter an energy-saving mode. This is to reduce the discharge of the vehicle battery. When the vehicle is unlocked while in this mode, the reaction time of the system may be a little longer than normal. Unlocking the vehicle once will deactivate the energy-saving mode.

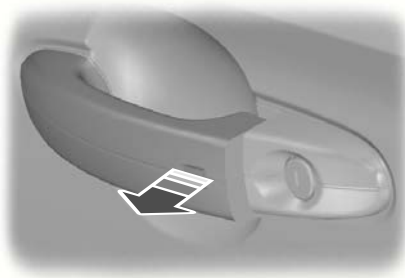

E78278

Pull one of the door handles or the luggage compartment lid handle.

Note: A valid passive key must be located within the detection range of that door.

One long flash of the direction indicators confirms that all the doors, the luggage compartment lid and the fuel filler flap have been unlocked and that the alarm has been disarmed.

Unlocking only the driver's door

If the unlocking function is reprogrammed so that only the driver's door is unlocked (See **Keys and remote controls** (page 31).), note the following:

If the driver's door is the first door which is opened, the other doors and the luggage compartment lid will remain locked. All the other doors can be unlocked from inside the vehicle by pressing the unlock button next to the driver's door handle. Doors can be unlocked individually by pulling the interior door handles on those doors.

If the front passenger door or one of the rear doors is the first door which is opened, **all** the doors and the luggage compartment lid will be unlocked.

Locks

Disabled keys

Any keys left inside the vehicle interior when it is locked will be disabled.

A disabled key cannot be used to turn the ignition on or start the engine.

In order to use these passive keys again, they have to be enabled.

To enable all your passive keys, unlock the vehicle using a passive key or the remote control unlocking function.

All passive keys will then be enabled if the ignition is turned on or the vehicle is started using a valid key.

Locking and unlocking the doors with the key blade

Type 1

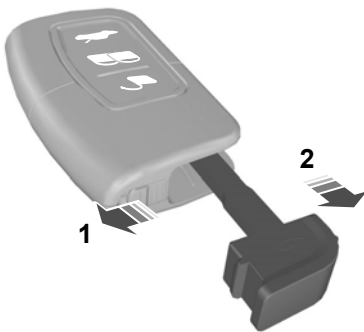

E78284

1. Slide the release slider in the direction of the arrow and pull out the key blade with your thumb.
2. Remove the key blade and insert it into the lock.

Type 2



E87964

1. Carefully remove the cover.
2. Remove the key blade and insert it into the lock.

Engine immobiliser

PRINCIPLE OF OPERATION

The engine immobiliser is a theft protection system that prevents someone from starting the engine with an incorrectly coded key.

If you are unable to start the engine with a correctly coded key, this indicates a malfunction. The message **Immobiliser active** will appear in the information display when you switch on the ignition. Have the immobiliser checked immediately.

CODED KEYS

Note: *Do not shield your keys with metal objects. This may prevent the receiver from recognising your key as a valid one.*

Note: *Have all of your remaining keys erased and recoded if you lose a key. Ask your dealer for further information. Have replacement keys recoded together with your existing keys.*

If you lose a key, you can obtain a replacement from your Ford Dealer. If possible, provide them with the key number from the tag provided with the original keys. You can also obtain additional keys from your Ford Dealer.

ARMING THE ENGINE IMMOBILISER

The engine immobiliser is armed automatically a short time after you have switched the ignition off.

DISARMING THE ENGINE IMMOBILISER

The engine immobiliser is disarmed automatically when you switch the ignition on with a correctly coded key.

If the message **Immobiliser active** appears in the information display, your key has not been recognised. Remove the key and try again.

Alarm

PRINCIPLE OF OPERATION

Alarm system

Your vehicle may be equipped with one of the following alarm systems:

- Perimeter alarm.
- Perimeter alarm with interior sensors.
- Category one alarm with interior sensors and battery back-up sounder.
- Category one alarm with interior sensors, battery back-up sounder and tilt sensors.

Perimeter alarm

The perimeter alarm is a deterrent against unauthorised access to your vehicle through the doors and the bonnet. It also protects the audio unit.

Interior sensors



E71401

WARNING



The sensors in the interior lamp unit must not be covered up. Do not activate the alarm with full guard if any persons, animals or other moving objects are inside the vehicle.

The sensors act as a deterrent against unauthorised intrusion by sensing any movement within the vehicle.

Battery back-up sounder

The battery back-up sounder is an extra alarm system which will sound a siren when the alarm is triggered. It is armed directly when you lock the vehicle. The sounder has its own battery and will sound an alarm siren even if someone disconnects the vehicle battery or the battery back-up sounder itself.

Tilt sensors

The tilt sensors detect if someone attempts to steal a wheel or tow the vehicle away by sensing changes in the inclination of the vehicle.

Note: *When travelling on a ferry with the alarm armed, deactivate the tilt sensors by selecting reduced guard. This will prevent the alarm from being triggered by the movement.*

Triggering the alarm

Once armed, the alarm is triggered in any of the following ways:

- If someone opens a door, the tailgate or the bonnet without a valid key or remote control.
- If someone removes the audio or navigation system.
- If the ignition is turned to position **I**, **II** or **III** without a valid key.
- If the interior sensors detect movement within the vehicle.
- On vehicles with a battery back-up sounder, if someone disconnects the vehicle battery or the battery back-up sounder itself.
- If the tilt sensors detect a change in the inclination of the vehicle.

If the alarm is triggered, the alarm horn will sound for 30 seconds and the hazard warning flasher will flash for five minutes.

Alarm

Any further attempts to perform one of the above will trigger the alarm again.

Full and reduced guard

Full guard

Full guard is the standard setting.

In full guard, the interior and tilt sensors are activated when you arm the alarm.

Note: This may result in false alarms if animals or moving objects are inside the vehicle or, on vehicles with tilt sensors, when travelling on a ferry.

Reduced guard

In reduced guard, the interior and tilt sensors are deactivated when you arm the alarm.

Note: You can set the alarm to reduced guard for the current ignition cycle only. The next time you switch on the ignition, the alarm will be reset to full guard.

Ask on Exit

You can set the information display to ask you each time which level of guard you wish to set.

If you select **Ask on Exit**, the message **Reduced guard?** appears in the instrument cluster display each time you switch the ignition off.

If you wish to arm the alarm with reduced guard, press the **OK** button when this message appears.

If you wish to arm the alarm with full guard, leave the vehicle without pressing the **OK** button.

Selecting full or reduced guard

Note: Selecting **Reduced** does not set the alarm permanently to reduced guard. It sets it to reduced guard only for the current ignition cycle. If you regularly set the alarm to reduced guard, select **Ask on Exit**.



E70499

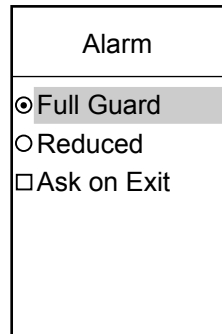

E74509

1. Press the right arrow button on the steering wheel to enter the main menu.
2. Highlight **Setup** with the up and down arrow buttons and press the right arrow button.
3. Highlight **Alarm** and press the right arrow button.

Alarm

4. Highlight **Reduced** or **Full guard**. If you prefer to be asked each time you switch off the ignition, select **Ask on Exit**.
5. Press the **OK** button to confirm the selection.
6. Press the left arrow button to exit the menu. To return to the trip computer display directly, hold the left arrow button pressed.

Information messages

See **Information messages** (page 91).

ARMING THE ALARM

To arm the alarm, lock the vehicle. See **Locks** (page 35).

DISARMING THE ALARM

Vehicles without keyless entry

Perimeter alarm

Disarm and silence the alarm by unlocking the doors with the key and switching the ignition on with a correctly coded key, or unlocking the doors or the luggage compartment lid with the remote control.

Category one alarm

Disarm and silence the alarm by unlocking the doors with the key and switching the ignition on with a correctly coded key within 12 seconds, or unlocking the doors or the luggage compartment lid with the remote control.

Vehicles with keyless entry

Note: *A valid passive key must be located within the detection range of that door for keyless entry. See **Keyless entry** (page 39).*

Perimeter alarm

Disarm and silence the alarm by unlocking the doors and switching the ignition on, or unlocking the doors or the luggage compartment lid with the remote control.

Category one alarm

Disarm and silence the alarm by unlocking the doors and switching the ignition on within 12 seconds, or unlocking the doors or the luggage compartment lid with the remote control.

Steering wheel

ADJUSTING THE STEERING WHEEL

WARNING

 Never adjust the steering wheel when the vehicle is moving.

Note: Make sure that you are sitting in the correct position. See **Sitting in the correct position** (page 114).

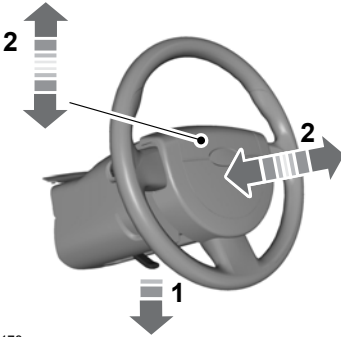

E95178



E95179

WARNING

 Make sure that you fully engage the locking lever when returning it to its original position.

AUDIO CONTROL

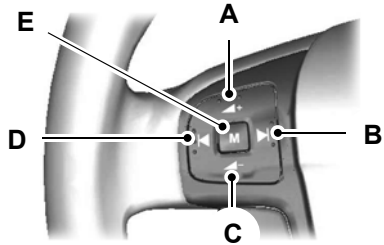

E72288

- A Volume up
- B Seek up
- C Volume down
- D Seek down
- E Mode

Mode

Press and **hold** the mode button to select the audio source.

Press the mode button to:

- tune the radio to the next preset station
- play the next CD
- play the other side of a cassette tape
- accept an incoming telephone call.
- end a telephone call.

Steering wheel

Seek

Press a seek button to:

- tune the radio to the next station up or down the frequency band
- play the next or the previous CD track
- fast forward or rewind the cassette tape.

Press and **hold** a seek button to:

- tune the radio up or down the frequency band
- seek through a CD track.

Wipers and washers

WINDSCREEN WIPERS

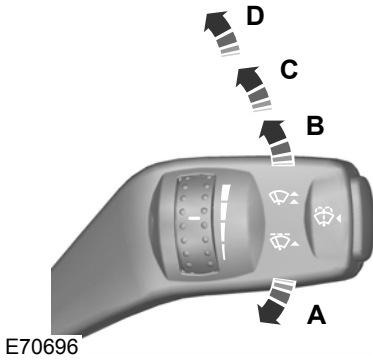

- A Single wipe
- B Intermittent wipe
- C Normal wipe
- D High speed wipe

Intermittent wipe

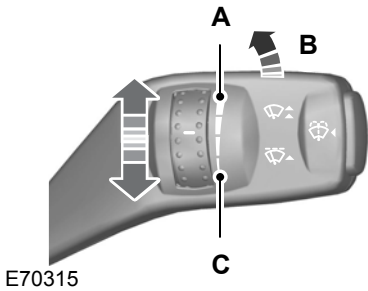

- A Short wipe interval
- B Intermittent wipe
- C Long wipe interval

AUTOWIPERS

CAUTIONS

- ! Do not switch autowipers on in dry weather conditions. The rain sensor is very sensitive and the wipers may operate if dirt, mist or flies hit the windscreen.
- ! Replace the wiper blades as soon as they begin to leave bands of water and smears. If you do not replace them, the rain sensor will continue to detect water on the windscreen and the wipers will operate, even though the majority of the windscreen is dry.
- ! Fully defrost the windscreen in icy conditions before you switch autowipers on.
- ! Switch autowipers off before you enter a car wash.

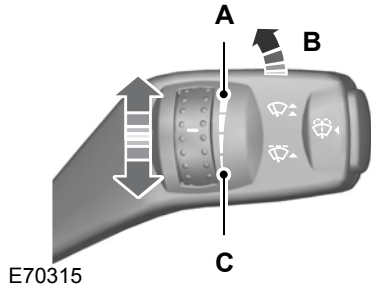

- A High sensitivity
- B On
- C Low sensitivity

Wipers and washers

If you switch autowipers on, the wipers will not cycle until water is detected on the windscreen. The rain sensor will then continuously measure the amount of water on the windscreen and adjust the speed of the wipers automatically.

Adjust the sensitivity of the rain sensor using the rotary control. With low sensitivity, the wipers will operate when the sensor detects a lot of water on the windscreen. With high sensitivity, the wipers will operate if the sensor detects a small amount of water on the windscreen.

WINDSCREEN WASHERS

WARNING



Do not operate the windscreen washers for more than 10 seconds or when the reservoir is empty.

Note: *The washer jets are heated when the ignition is on.*

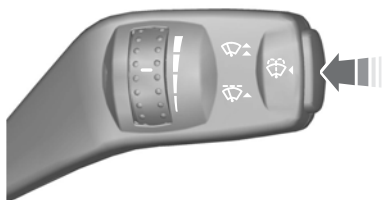

E70776

REAR WINDOW WIPER AND WASHERS

Intermittent wipe

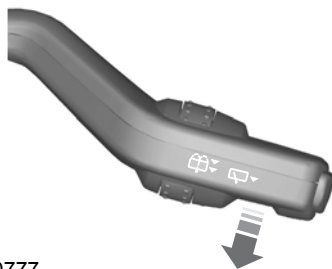

E70777

Reverse gear wipe

The rear window wiper will operate automatically when you select reverse gear if the wiper lever is in position **B**, **C** or **D**.

Washer

WARNING



Do not operate the rear window washer for more than 10 seconds or when the reservoir is empty.

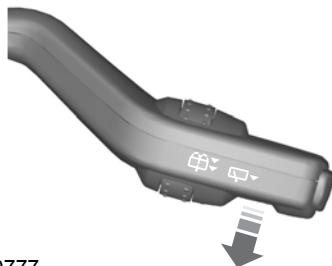

E70777

Pull the lever fully towards the steering wheel and hold it to operate the washer.

Wipers and washers

HEADLAMP WASHERS

The headlamp washers will operate with the windscreen washers when the headlamps are on.

Note: *To stop the washer fluid reservoir emptying quickly, the headlamp washers will not operate every time that you use the windscreen washers.*

CHECKING THE WIPER BLADES

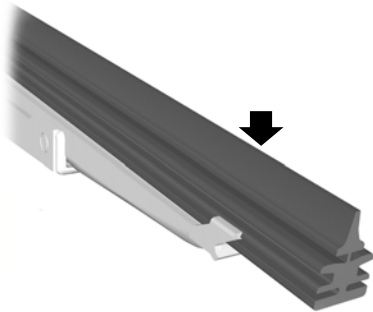

E66644

Run the tip of your fingers over the edge of the blade to check for roughness.

Clean the wiper blade lips with water applied with a soft sponge.

CHANGING THE WIPER BLADES

Windscreen wiper blades

CAUTIONS

! Set the windscreen wipers in the service position to change the wiper blades.

CAUTIONS

! You can use the service position in winter to provide easier access to the wiper blades for freeing them from snow and ice. The windscreen wipers will return to their normal position as soon as you switch on the ignition so make sure that the outside of the windscreen is free from snow and ice before you switch on the ignition.

Service position



E85833

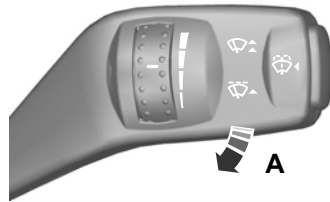

E75188

Switch off the ignition and move the wiper lever to position **A** within three seconds. Release the lever when the windscreen wipers have moved to the service position.

Wipers and washers

Changing the windscreen wiper blades

Set the windscreen wipers in the service position and lift the wiper arms.

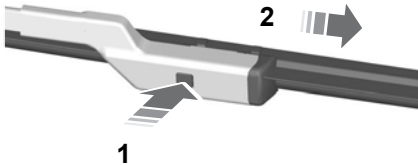

E72899

1. Press the locking button.
2. Remove the wiper blade.

Note: Make sure that the wiper blade locks into place.

3. Install in the reverse order.

Rear window wiper blades

Changing the rear window wiper blades - Estate

1. Lift the wiper arm.

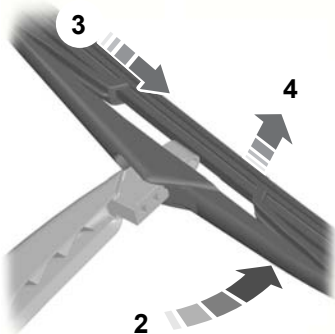

E86456

2. Position the wiper blade at right angles to the wiper arm.
3. Disengage the wiper blade from the wiper arm.

4. Remove the wiper blade.

Note: Make sure that the wiper blade locks into place.

5. Install in the reverse order.

Changing the rear window wiper blades - 5-door

1. Lift the wiper arm.

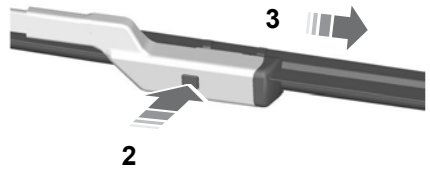

E86457

2. Press the locking button.
3. Remove the wiper blade.

Note: Make sure that the wiper blade locks into place.

4. Install in the reverse order.

Lighting

LIGHTING CONTROL

Lighting control positions

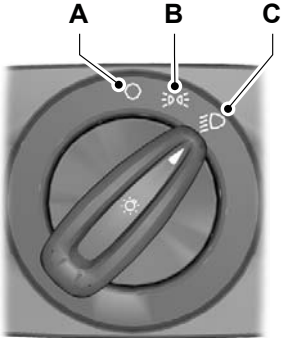

E70718

- A Off
- B Side and tail lamps
- C Headlamps

Parking lamps

CAUTION

 Prolonged use of the parking lamps will discharge the battery.

Switch off the ignition.

Both sides

Set the lighting control to position **B**.

One side

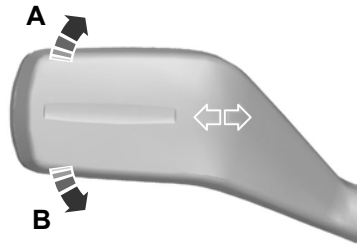

E75505

- A Right-hand side
- B Left-hand side

Main and dipped beam

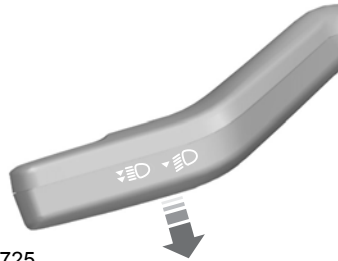

E70725

Pull the lever fully towards the steering wheel to switch between main and dipped beam.

Headlamp flasher

Pull the lever slightly towards the steering wheel.

Lighting

Home safe lighting

Switch the ignition off and pull the direction indicator lever towards the steering wheel to switch the headlamps on. You will hear a short tone. The headlamps will go off automatically after three minutes with any door open, or 30 seconds after the last door has been closed.

With all doors closed, but within the 30 second delay, opening any door will result in the three minute timer starting again.

The home safe lights can be cancelled by either pulling the direction indicator lever towards the steering wheel again or by turning the ignition switch on.

AUTOLAMPS

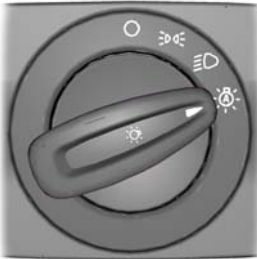

E70719

Note: *If you have switched autolamps on, you can only switch the main beam on when autolamps has switched the headlamps on.*

The headlamps will come on and go off automatically depending on the ambient light.

FRONT FOG LAMPS



E70721

WARNING



Only use the front fog lamps when visibility is considerably restricted by fog, snow or rain.

REAR FOG LAMPS



E70720

WARNINGS



Only use the rear fog lamps when visibility is restricted to less than 50 metres.



Do not use the rear fog lamps when it is raining or snowing and visibility is more than 50 metres.

Lighting

ADJUSTING THE HEADLAMPS - VEHICLES WITH: ADAPTIVE FRONT LIGHTING/XENON HEADLAMPS

To adjust the headlamps for driving on the left or right hand side of the road, see your dealer.

HEADLAMP LEVELLING

Note: Vehicles with Xenon headlamps are equipped with automatic headlamp levelling.

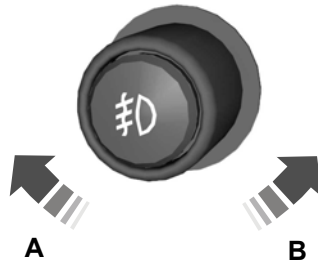

E70722

- A Raised headlamp beams
- B Lowered headlamp beams

You can adjust the level of the headlamp beams according to the vehicle load.

Recommended headlamp levelling switch positions

Load		Load in luggage compartment	Switch position
Front seats	Second row seats		
1-2	-	-	0
1-2	-	-	0 (0.5 ²)
1-2	3	-	1 (0.5 ²)
1-2	3	Max ¹	3 (0.5 ²)
1	-	Max ¹	4 (1.5 ²)

¹ See **Vehicle identification** (page 234).

² Vehicles with active suspension.

Lighting

HAZARD WARNING FLASHERS



Note: Depending on applicable laws and regulations in the country for which your vehicle was originally built, the hazard warning flashers may flash if you brake heavily.

For item location: See **Quick start** (page 10).

ADAPTIVE FRONT LIGHTING SYSTEM (AFS)

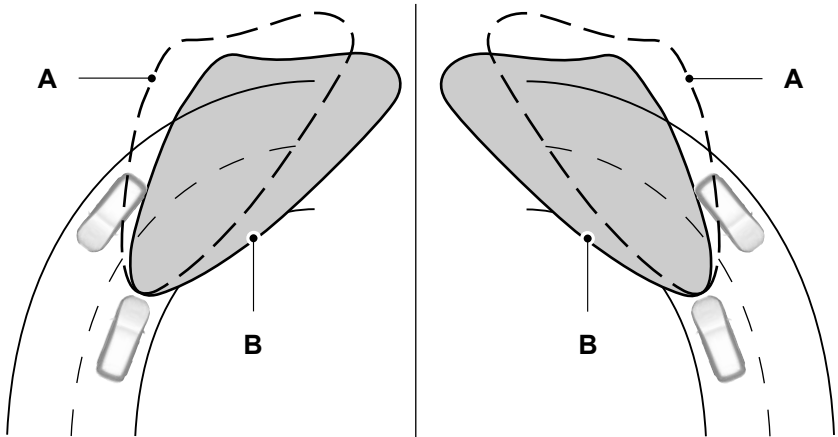

E72897

- A without AFS
- B with AFS

The AFS adjusts the headlamp dipped beam depending on vehicle direction and speed. It improves visibility when you are driving at night and helps to reduce headlamp glare for oncoming drivers.

The system will not operate when the vehicle is stationary, when you have switched on the daytime running lamps or when you have selected reverse gear.

Lighting

A message will appear in the information display if the system malfunctions. See **Information messages** (page 91). The headlamps will move to a fixed central or dipped position. Have the system checked as soon as possible.

Cornering lamps

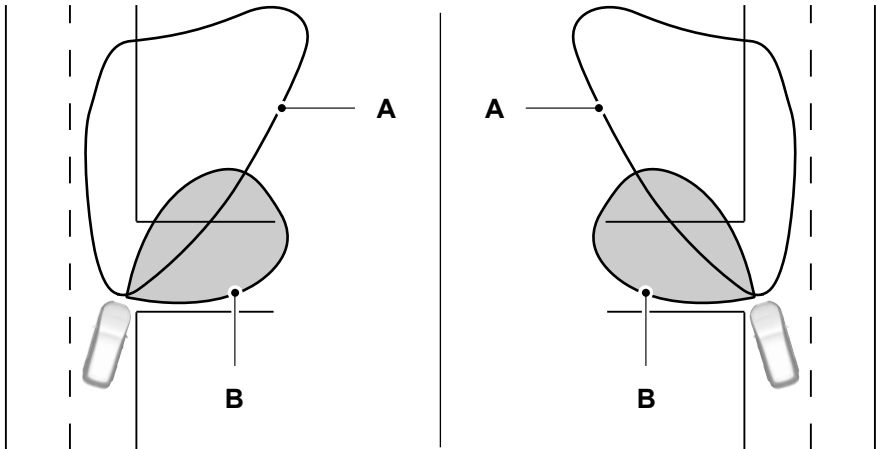

E72898

- A Headlamp beam
- B Cornering lamp beam

The cornering lamps illuminate the inside of a corner when you are turning.

Lighting

DIRECTION INDICATORS

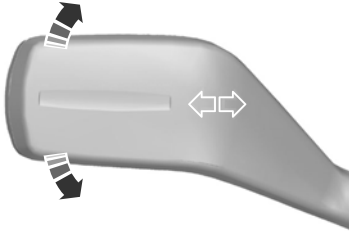

E70727

Note: Tap the lever up or down to make the direction indicators flash only three times.

INTERIOR LAMPS

Courtesy lamp

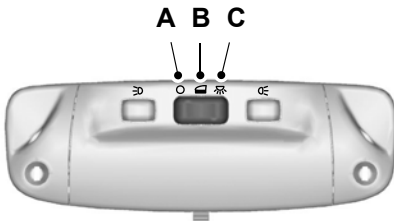

E71945

- A Off
- B Door contact
- C On

If you set the switch to position **B**, the courtesy lamp will come on when you unlock or open a door or the luggage compartment lid. If you leave a door open with the ignition switch off, the courtesy lamp will go off automatically after some time to prevent the vehicle battery from discharging. To switch it back on, switch on the ignition for a short time.

The courtesy lamp will also come on when you switch off the ignition. It will go off automatically after a short time or when you start or restart the engine.

If you set the switch to position **C** with the ignition switch off, the courtesy lamp will come on. It will go off automatically after a short time to prevent the vehicle battery from discharging. To switch it back on, switch on the ignition for a short time.

Reading lamps

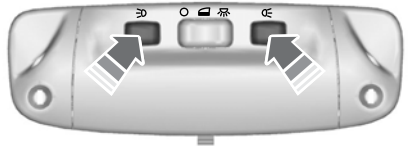

E71946

If you switch off the ignition, the reading lamps will go off automatically after some time to prevent the vehicle battery from discharging. To switch them back on, switch on the ignition for a short time.

Lighting

Vanity mirror lamps

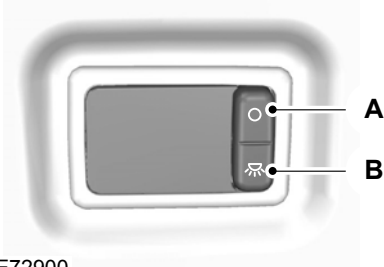

E72900

- A Off
- B On

If you switch off the ignition, the vanity mirror lamps will go off automatically after a short time to prevent the vehicle battery from discharging. To switch them back on, switch on the ignition for a short time.

REMOVING A HEADLAMP

WARNING



Have Xenon bulbs changed by a trained technician. There is a risk of electric shock.

1. Open the bonnet. See **Opening and closing the bonnet** (page 199).

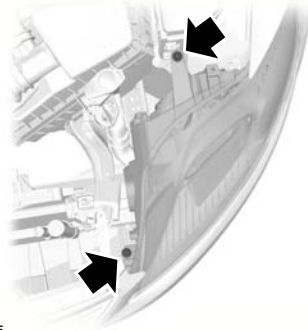

E85995

2. Remove the screws.

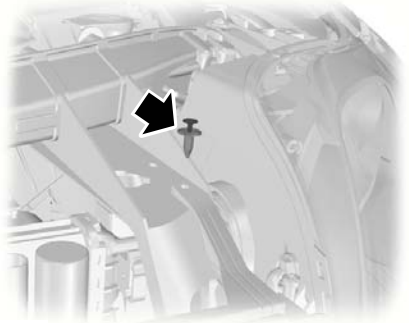

E88843

3. Remove the plastic screw and retainer.

Lighting

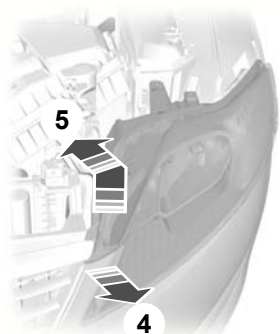

E85996

4. Carefully pull the corner of the grille and bumper towards the front of the vehicle.
5. Carefully lift the corner of the headlamp and push it as far as possible towards the back of the vehicle.

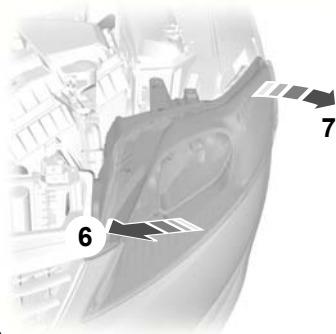

E88982

6. Carefully pull the headlamp towards the centre of the vehicle, behind the grille and bumper, to disengage it from the lower outer fixing point.
7. Remove the headlamp.

CAUTION

- ⚠ When fitting the headlamp, take care not to damage the locating points.

Note: When fitting the headlamp, make sure that you fully engage the headlamp in the lower outer fixing point.

Note: When fitting the headlamp, tighten the front screw first and then the rear screw.

CHANGING A BULB

WARNINGS

- ⚠ Switch the lights and the ignition off.
- ⚠ Let the bulb cool down before removing it.
- ⚠ Have Xenon bulbs changed by a trained technician. There is a risk of electric shock.

CAUTIONS

- ⚠ Do not touch the glass of the bulb.
- ⚠ Only fit bulbs of the correct specification. See **Bulb specification chart** (page 66).

Note: The following instructions describe how to remove the bulbs. Fit replacements in the reverse order unless otherwise stated.

Headlamp

Note: Remove the covers to gain access to the bulbs.

Direction indicator

1. Remove the headlamp. See **Removing a headlamp** (page 58).

Lighting

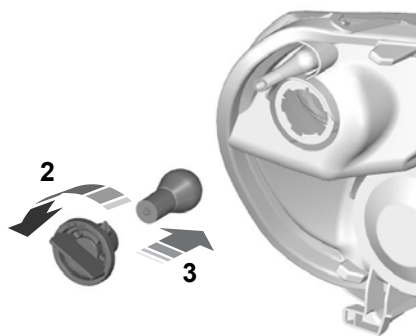

E72259

2. Turn the bulb holder anti-clockwise and remove it.
3. Gently press the bulb into the bulb holder, turn it anti-clockwise and remove it.

Headlamp main beam

1. Remove the headlamp. See **Removing a headlamp** (page 58).

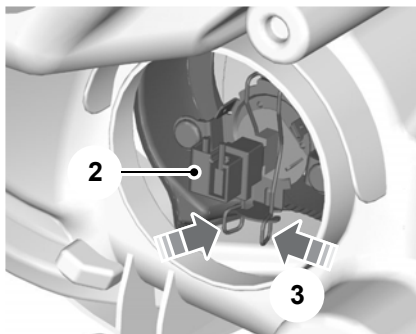

E72261

2. Disconnect the electrical connector.
3. Release the clip and remove the bulb.

Headlamp dipped beam

1. Remove the headlamp. See **Removing a headlamp** (page 58).

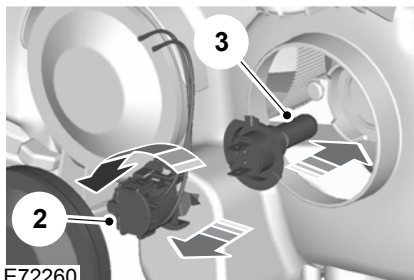

E72260

2. Turn the bulb holder anti-clockwise and remove it.
3. Remove the bulb.

Cornering lamp

1. Remove the headlamp. See **Removing a headlamp** (page 58).

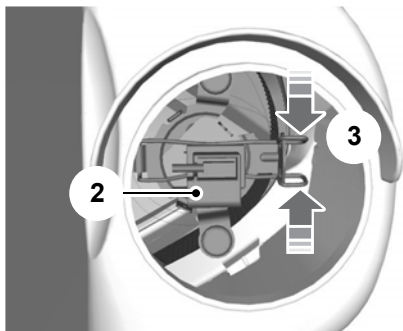

E72262

2. Disconnect the electrical connector.
3. Release the clip and remove the bulb.

Lighting

Side repeaters

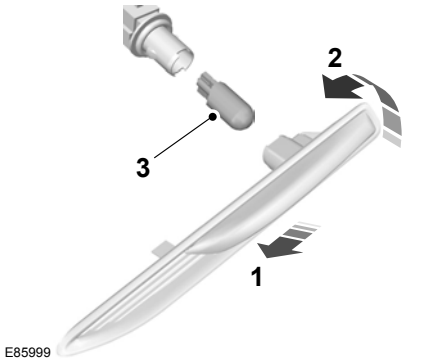

1. Carefully remove the side repeater.
2. Hold the bulb holder, turn the housing anti-clockwise and remove it.
3. Remove the bulb.

Approach lamp



E72264

Note: Position the mirror glass as far inwards as possible.

1. Insert a screwdriver into the gap between the mirror housing and the mirror glass and release the metal retaining clip.

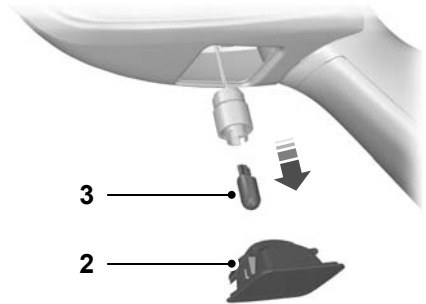

E72265

2. Remove the lamp.
3. Remove the bulb.

Front fog lamps

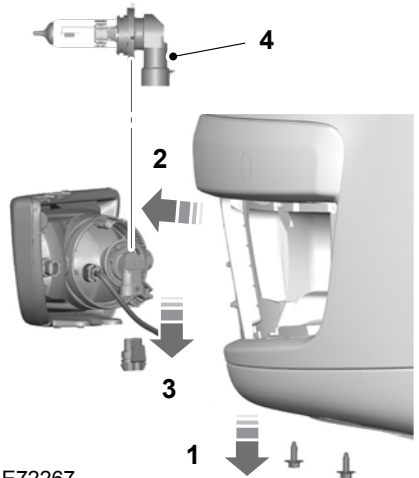

E72267

Note: You cannot separate the fog lamp bulb from the bulb holder.

Note: Do not remove the screws.

1. Loosen the screws.

Lighting

2. Remove the lamp.
3. Disconnect the electrical connector.
4. Turn the bulb holder anti-clockwise and remove it.

Rear lamps

Direction indicator, tail and brake lamp

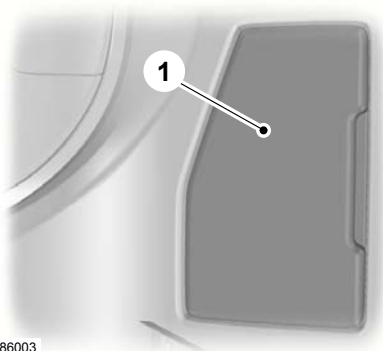

E86003

1. Remove the trim panel.

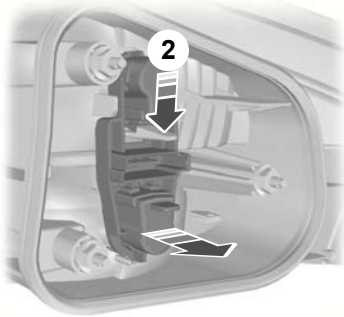

E86004

2. Unclip the bulb holder.

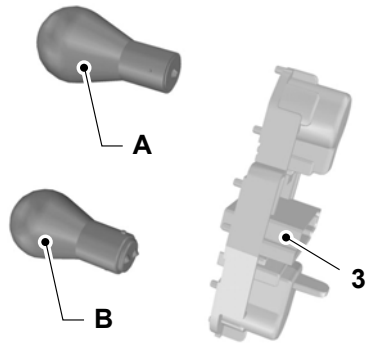

E86005

- A Direction indicator
- B Tail and brake lamp

3. Gently press the bulb into the bulb holder, turn it anti-clockwise and remove it.

Reversing lamp, tail lamp and fog lamp

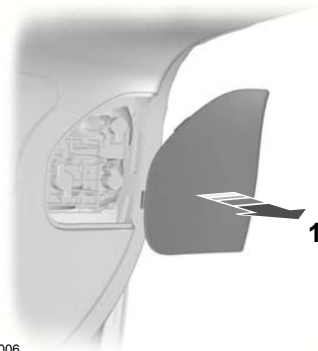

E86006

1. Remove the trim panel.

Lighting

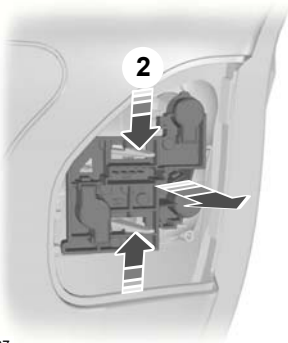

E86007

2. Unclip the bulb holder.

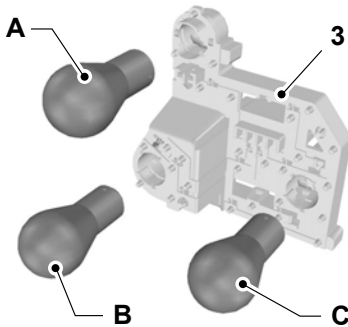

E86008

- A Reversing lamp
- B Tail lamp
- C Fog lamp

3. Gently press the bulb into the bulb holder, turn it anti-clockwise and remove it.

Central high mounted brake lamp

Remove the trim panel

4-door



E87617

1. Detach the clips.

5-door

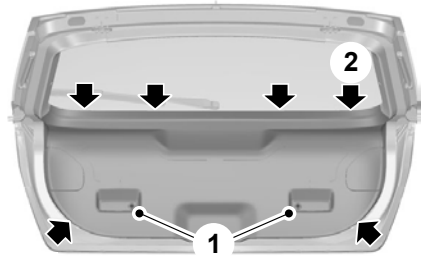

E87618

1. Remove the screws.

2. Detach the clips.

Lighting

Estate



E87619

1. Detach the clips.

Remove the lamp

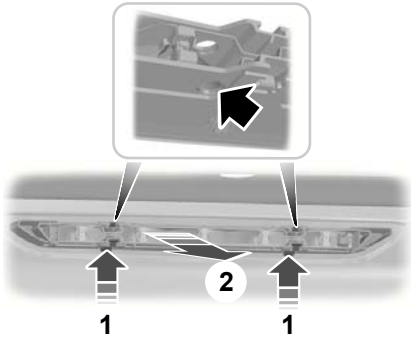

E87620

1. Insert a suitable object into the holes.
2. Carefully pull the lamp towards the front of the vehicle to release the spring clips.



E86002

3. Remove the lamp.

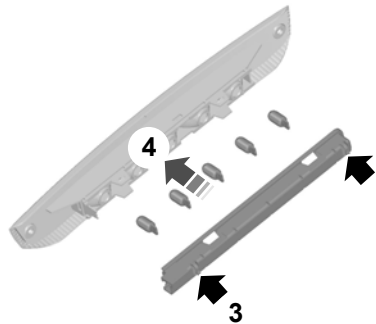

E79601

4. Unclip the bulb holder.
5. Remove the bulb.

Lighting

Number plate lamp

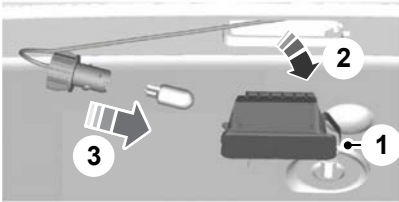

E72789

1. Carefully release the spring clip.
2. Remove the lamp.
3. Remove the bulb.

Interior lamp

Vehicles without interior sensors

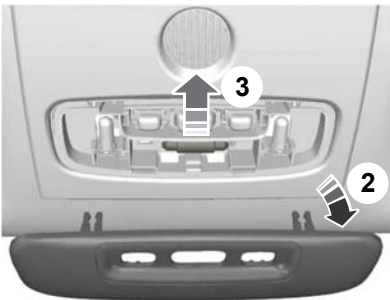

E72788

1. Carefully prise out the lens.
2. Remove the lens.
3. Remove the bulb.

Vehicles with interior sensors

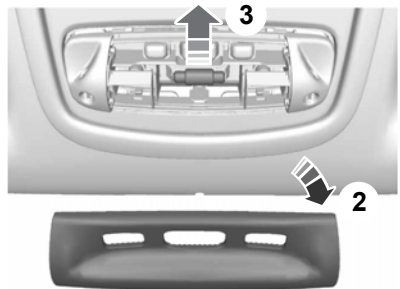

E72787

1. Carefully prise out the lens.
2. Remove the lens.
3. Remove the bulb.

Reading lamps

Vehicles without interior sensors

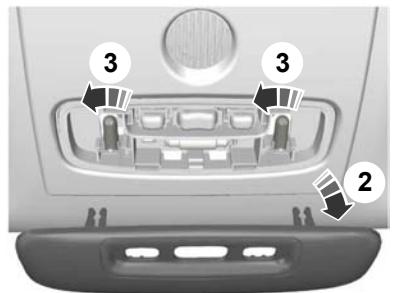

E72796

1. Carefully prise out the lens.
2. Remove the lens.
3. Remove the bulb.

Lighting

Vehicles with interior sensors

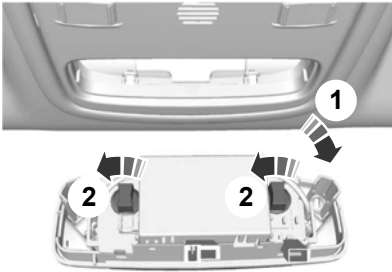

E72786

1. Carefully prise out the lamp.
2. Turn the bulb holder anti-clockwise and remove it.

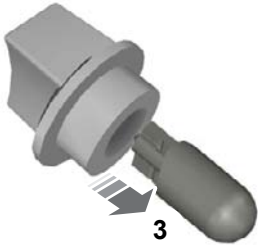

E73939

3. Remove the bulb.

Vanity mirror lamp

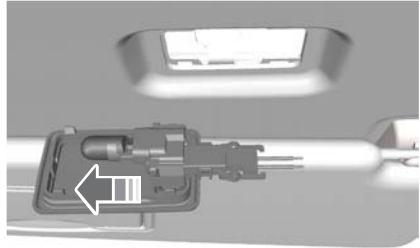

E72785

1. Carefully prise out the lamp.
2. Remove the bulb.

Luggage compartment lamp

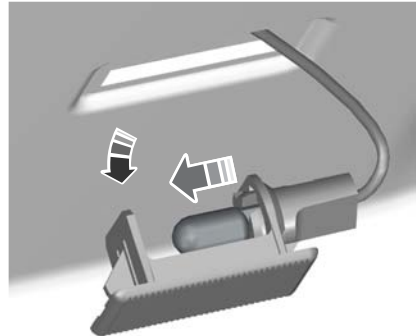

E72784

1. Carefully prise out the lamp.
2. Remove the bulb.

BULB SPECIFICATION CHART

Lamp	Specification	Power (watt)
Front direction indicator	PY21W	21
Headlamp main beam	H1	55

Lighting

Lamp	Specification	Power (watt)
Headlamp dipped beam	H7	55
Cornering lamp	H1	55
Side repeater	W5W	5
Approach lamp	W5	5
Front fog lamp	H8	35 ¹
Front fog lamp	H11	55 ¹
Side lamp	W5W	5
Rear direction indicator	PY21W	21
Brake and tail lamp	P21/5W	21/5
Tail lamp	P21/4W	4
Rear fog lamp	P21/5W	21/5
Reversing lamp	P21W	21
Central high mounted brake lamp	5 x W5W	5
Number plate lamp	W5W	5
Interior lamp	Festoon	10
Reading lamp	BA 9s	5
Vanity mirror lamp	W5W	5
Luggage compartment lamp	W5W	5

¹Fit a replacement with the same rating as the one you have removed.

Windows and mirrors

ELECTRIC WINDOWS

WARNING



Do not operate the electric windows unless they are free from obstruction.

Note: If you operate the switches often during a short period of time, the system might become inoperable for a certain time to prevent damage due to overheating.

Note: You can operate the windows for several minutes after you switch off the ignition. They will be deactivated as soon as a door is opened.

Note: If you operate both the switch on the relevant door and the switch for that window on the driver's door at the same time, the window will stop moving.

Switch on the ignition to operate the electric windows.

Global opening and global closing

You can also operate the electric windows with the ignition off via the global opening and global closing function. See **Global opening and closing** (page 37).

Note: Global opening and global closing will open or close the windows automatically only on vehicles equipped with four electric windows.

Note: Global closing will only operate if you have set the memory correctly for each window.

Driver's door switches



E121510

You can operate all the windows with the switches on the door trim panel of the driver's door.

Front and rear passengers' door switches

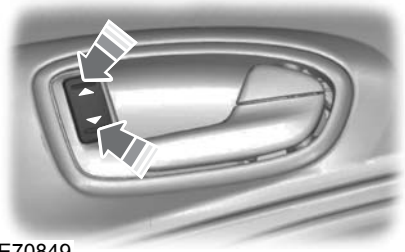

E70849

Opening and closing the windows automatically

Press or lift the switch to the second action point and release it. Press or lift it again to stop the windows.

Windows and mirrors

Safety switch for rear windows

Note: You can always operate the rear windows from the driver's door.



E121511

A switch in the driver's door disables the rear electric window switches.

The light in the switch illuminates and the lights in the rear window switches go off when the rear windows are disabled.

Anti-trap function

WARNING



Careless closing of the windows can override the protection function and cause injuries.

The electric windows will stop automatically while closing and reverse some distance if there is an obstacle in the way.

Overriding the anti-trap function

CAUTION



While you close the window for the third time, the anti-trap function is disabled. Make sure there are no obstacles in the way of the closing window.

To override this protection function when there is a resistance, for example, in the winter, proceed as follows:

1. Close the window twice until it reaches the resistance and let it reverse.
2. Close the window a third time to the resistance. The anti-trap function is disabled and you cannot close the window automatically. The window will override the resistance and you can close it fully.
3. If the window does not close after the third attempt, have it checked by a properly trained technician.

Resetting the memory of the electric windows

WARNING



The anti-trap function is deactivated until you have reset the memory.

After the battery has been disconnected from the vehicle you must reset the memory separately for each window:

1. Lift the switch until the window is fully closed. Hold the switch lifted for one more second.
2. Release the switch and lift it again, two or three times, for one more second.
3. Open the window and try to close it automatically.
4. Reset and repeat procedure if the window does not close automatically.

Windows and mirrors

Safety mode

WARNING



The anti-trap function is not active during this procedure.

If the system detects a malfunction, it enters a safety mode. The windows will move for only about 0.5 seconds at a time and then stop again. Close the windows by pressing the switch again when the windows stop moving. Have this checked immediately.

EXTERIOR MIRRORS

WARNING



Do not overestimate the distance of the objects that you see in the convex mirror. Objects seen in convex mirrors will appear smaller and further away than they actually are.

Manual folding mirrors

Folding

Push the mirror towards the door window glass.

Unfolding

Make sure that you fully engage the mirror in its support when returning it to its original position.

ELECTRIC EXTERIOR MIRRORS

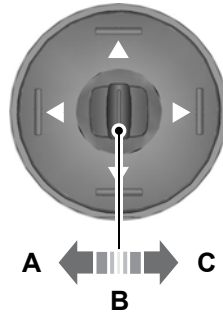

E70846

- A Left-hand mirror
- B Off
- C Right-hand mirror

Mirror tilting positions

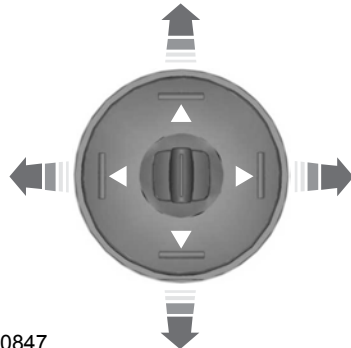

E70847

The electric exterior mirrors are fitted with a heating element that will defrost or demist the mirror glass. See **Heated windows and mirrors** (page 105).

Windows and mirrors

Electric folding mirrors

Automatic folding and unfolding

Note: If the mirrors have been folded using the manual fold button they can only be unfolded using the manual fold button.

The mirrors will fold automatically when you lock the vehicle with the key, the remote control or a keyless entry system request. The mirrors will unfold when you unlock the vehicle with the key, the remote control, a keyless entry system request, the driver's interior door handle or starting the engine.

Manual folding and unfolding

The electric folding mirrors operate with the ignition on.

Note: You can operate the mirrors (mirror tilting and folding) for several minutes after you switch off the ignition. They will be deactivated as soon as a door is opened.



E72623

Press the button to fold or unfold the mirrors.

If you press the switch again while the mirrors are moving, they will stop and reverse the direction of movement.

Note: When the mirrors are operated often during a short period of time, the system may become inoperable for a period of time to prevent damage due to overheating.

Reverse mirror dipping

Depending on the switch position (**A** or **C**), the relevant exterior mirror will dip whenever you select reverse gear, giving you a view of the kerb.

Note: You can disable this feature by leaving the switch in position **B**.

The exterior mirror will return to the original position:

- If the vehicle speed exceeds 10 km/h (6 mph).
- Approximately 10 seconds after reverse gear has been disengaged.
- If the switch is returned to position **B**.

When you first use this feature, the mirror will dip to a preset position. This position can be adjusted using the following sequence:

1. Turn the ignition on. Do not start the engine.
2. Select the desired exterior mirror (**A** or **C**).
3. Select reverse gear, the selected exterior mirror will adjust to a preset position.
4. Adjust the mirror to the required dipped position.
5. Disengage reverse gear or press and hold the desired memory pre-set button until a single chime sounds to confirm. See **Memory function** (page 123).

The settings will be stored automatically.

Windows and mirrors

AUTO-DIMMING MIRROR

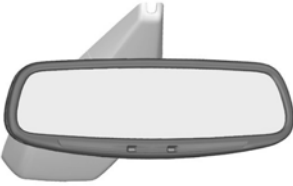

E71028

The auto-dimming mirror will adjust automatically when hit by glaring light from behind. It will not work when you have selected reverse gear.

Instruments

GAUGES

Type 1 and 2

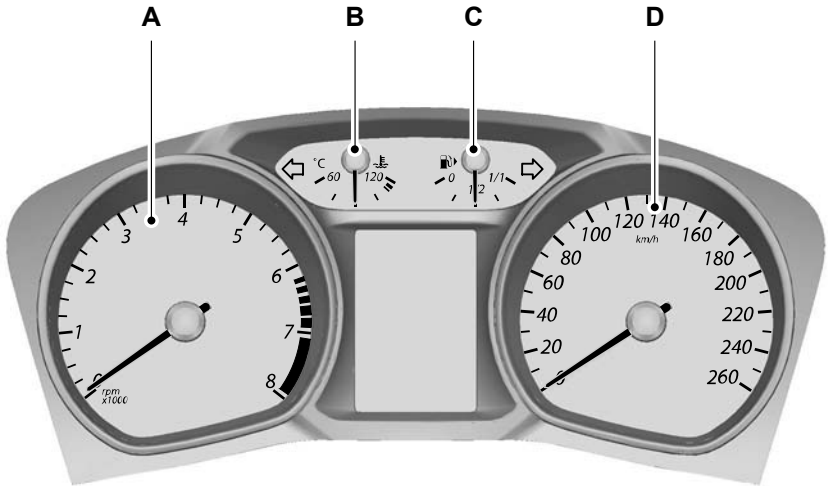

E72984

- A Tachometer
- B Engine coolant temperature gauge
- C Fuel gauge
- D Speedometer

Instruments

Type 3

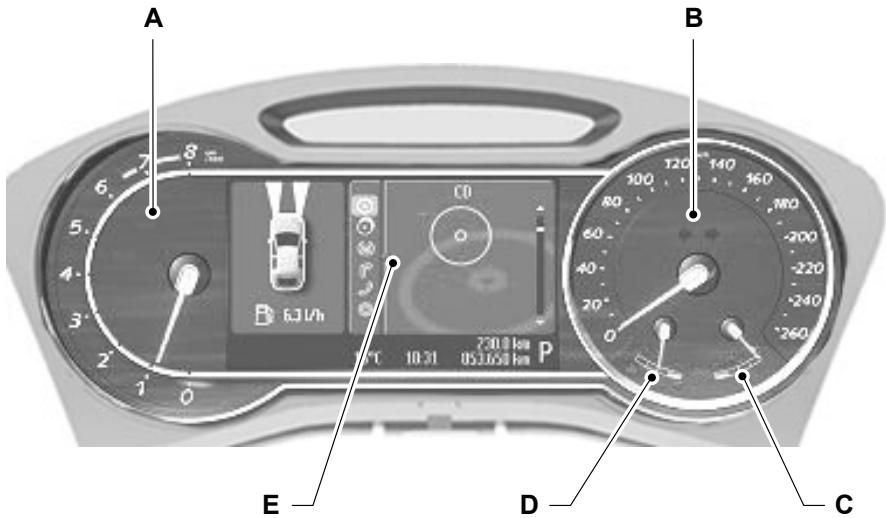

E87713

- A Tachometer
- B Speedometer
- C Engine coolant temperature gauge
- D Fuel gauge
- E Message centre. See **Information displays** (page 78).

Engine coolant temperature gauge

Shows the temperature of the engine coolant. At normal operating temperature, the needle will remain in the centre section.

CAUTION

- ⚠ Do not restart the engine until the cause of overheating has been resolved.

If the needle moves towards 120°C, the engine is overheating. Stop the engine, switch the ignition off and determine the cause **once the engine has cooled down**. See **Engine coolant check** (page 210).

Fuel gauge

The arrow adjacent to the fuel pump symbol tells you on which side of your vehicle the fuel filler cap is located.

Instruments

WARNING LAMPS AND INDICATORS

The following warning lamps and indicators will illuminate briefly when you switch the ignition on to confirm that the system is operational:

- ABS
- Airbag
- Brake system
- Engine
- Frost
- Ignition
- Oil pressure (all except 2.5L Duratec)
- Stability control (ESP).

If a warning or indicator lamp does not illuminate when the ignition is switched on, it indicates a malfunction. Have the system checked by properly trained technician.

ABS warning lamp



If it illuminates when you are driving, this indicates a malfunction. You will continue to have normal braking (without ABS). Have the system checked by a properly trained technician as soon as possible.

Airbag warning lamp



If it illuminates while driving, this indicates a malfunction. Have the system checked by a properly trained technician.

Brake system lamp



It illuminates when the parking brake is engaged.

WARNING



Reduce your speed gradually and stop your vehicle as soon as it is safe to do so. Use your brakes with care.

If it illuminates when you are driving, check that the parking brake is not engaged. If the parking brake is not engaged, this indicates a malfunction. Have the system checked by a properly trained technician immediately.

Cruise control indicator



It will illuminate when you have set a speed using the cruise control system. See **Using cruise control** (page 149). On vehicles with adaptive cruise control (ACC), the indicator will illuminate when ACC is active. See **Using ACC** (page 152).

Direction indicators



Flashes during operation. A sudden increase in the rate of flashing warns of a failed indicator bulb. See **Changing a bulb** (page 59).

Engine warning lamp



If it illuminates with the engine running, this indicates a malfunction. If it flashes when you are driving, **reduce the speed of your vehicle immediately**. If it continues to flash, avoid heavy acceleration or deceleration. Have the system checked by a properly trained technician immediately.

Instruments

CAUTION

 If the engine warning lamp illuminates in conjunction with a message, have the system checked as soon as possible.

Forward alert indicator

 It will illuminate when this feature is active. See **Forward alert function** (page 155).

Front fog lamp indicator

 It will illuminate when you switch the front fog lamps on.

Frost warning lamp

WARNING
 Even if the temperature rises to above 4°C (39.2°F) there is no guarantee that the road is free of hazards caused by inclement weather.

 It will illuminate and glow orange when the outside air temperature is between 4°C (39.2°F) and 0°C (32°F). It will glow red when the temperature is below 0°C (32°F).

Glow plug indicator

 See **Starting a diesel engine** (page 130).

Headlamp indicator

 It will illuminate when you switch the headlamp dipped beam or the side and tail lamps on.

Ignition warning lamp

 If it illuminates when you are driving, this indicates a malfunction. Switch off all unnecessary electrical equipment. Have the system checked by a properly trained technician immediately.

Low fuel level warning lamp

 If it illuminates, refuel as soon as possible.

Main beam indicator

 It will illuminate when you switch the headlamp main beam on. It will flash when you use the headlamp flasher.

Message indicator

 It will illuminate when a new message is stored in the information display. See **Information messages** (page 91).

Oil pressure warning lamp

CAUTION

 Do not resume your journey if it illuminates despite the level being correct. Have the system checked by a properly trained technician immediately.

 If it stays on after starting or illuminates when driving, this indicates a malfunction. Stop your vehicle as soon as it is safe to do so and switch the engine off. Check the engine oil level. See **Engine oil check** (page 210).

Instruments

Rear fog lamp indicator



It will illuminate when you switch the rear fog lamps on.

Seat belt reminder



See **Seat belt reminder** (page 29).

Shift indicator



It will illuminate to inform you that shifting to a higher gear may give better fuel economy and lower CO2 emissions. It will not illuminate during periods of high acceleration, braking or when the clutch pedal is pressed.

Stability control (ESP) warning lamp



While driving, it flashes during activation of the system. After switching on the ignition, if it does not illuminate or illuminates continuously while driving, this indicates a malfunction. During a malfunction, the system switches off. Have the system checked by a properly trained technician as soon as possible.

If you switch ESP off, the warning lamp will illuminate. The lamp will go out when you switch the system back on or when you switch the ignition off.

AUDIBLE WARNINGS AND INDICATORS

Switching the chimes on and off

You can deactivate certain chimes.

To set which chimes should sound:



E70499

1. Press the right arrow button on the steering wheel to enter the main menu.
2. Highlight **Setup** with the up and down arrow buttons and press the right arrow button.
3. Highlight **Chimes** and press the right arrow button.
4. Highlight the chime and press the **OK** button to switch the chime on and off.
5. Press the left arrow button to exit the menu. Press and hold the left arrow button to return to the main menu display.

Information displays

GENERAL INFORMATION

WARNING



Do not operate the information display controls when the vehicle is moving.

Note: *The information display will remain on for several minutes after you switch off the ignition.*

Various systems on your vehicle can be controlled using the buttons on your steering wheel. Corresponding information is displayed in the information display.

For detailed instructions on audio, navigation, phone etc. refer to the appropriate manual.

Controls



E70499

Instrument cluster functions

Function	Type 1	Type 2	Type 3
Trip computer	X	X	X
Information messages	X	X	X
Clock setup	X	X	X
Display settings	-	X	X
Park heater setup	-	X	X

Press the **up** and **down** arrow buttons:

- to scroll through the trip computer displays
- to scroll through and highlight the options within a menu.

Press the **right** arrow button:

- to enter the main menu from the trip computer displays
- to enter a sub-menu.

Press the **left** arrow button to exit a menu.

Hold the **left** arrow button pressed at any time to return to the main menu display (escape button).

Note: *The system will return to the trip computer displays automatically if you do not press any button for a period of time.*

Press the **OK** button to choose and confirm a setting.

Information displays

Function	Type 1	Type 2	Type 3
Navigation control	-	-	X
CD control	-	-	X
CD changer control	-	-	X
Radio control	-	-	X
Phone control	-	-	X
Auxiliary input control	-	-	X

Type 1

Press the **up** and **down** arrow buttons on the steering wheel to scroll through the trip computer displays. See **Trip computer** (page 87).

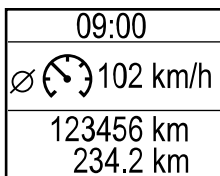

E80604

Menu structure

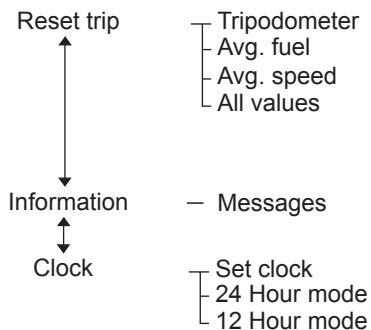

E87751

Information displays

Type 2

09:00
 Average Fuel 6.3 $\frac{l}{100km}$
123456 km 234.2 km

Press the **up** and **down** arrow buttons on the steering wheel to scroll through the trip computer displays. See **Trip computer** (page 87).

E74426

Information displays

Menu structure

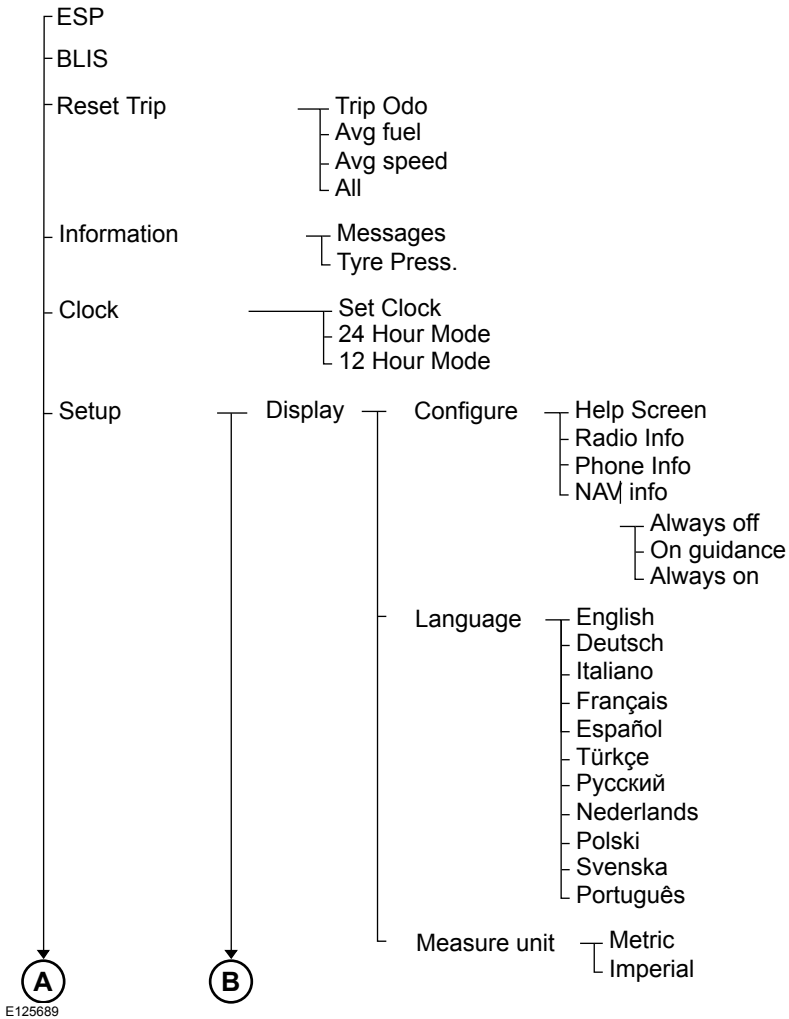

E125689

Information displays

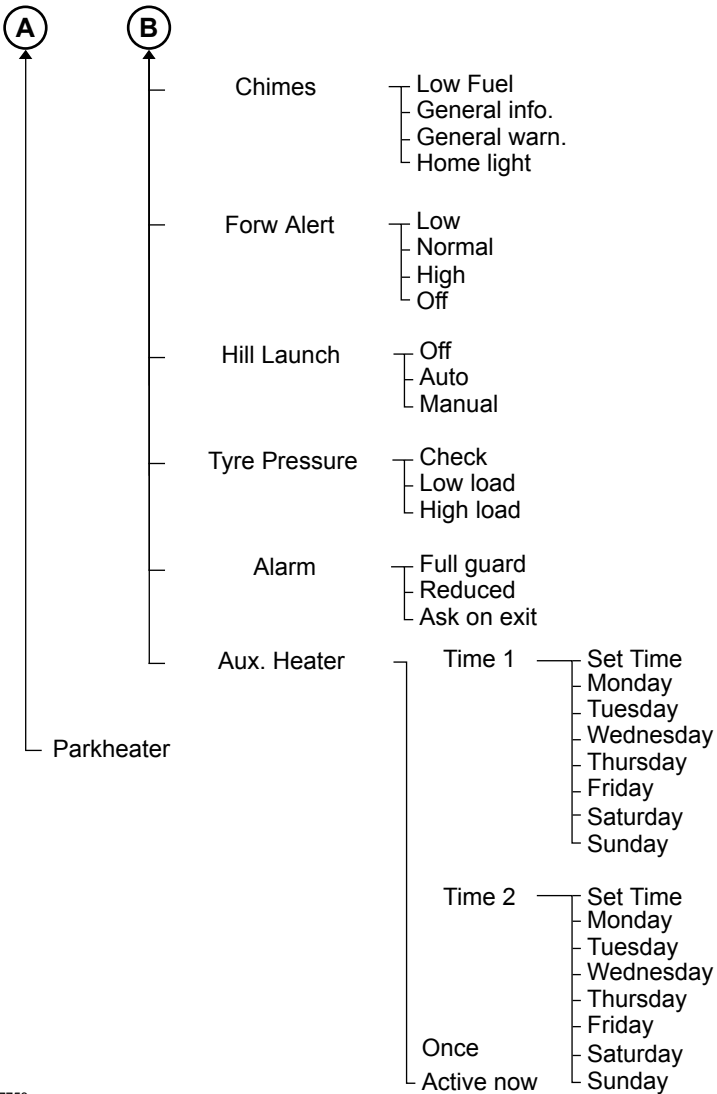

E87753

Information displays

Type 3



E88048

Use the controls to scroll through the menu displays.

Device list

The highlighted icon shows the current menu in use.



Navigation



CD



CD changer



Radio



Phone



Trip computer



Settings



Auxiliary input

Information displays

Menu structure

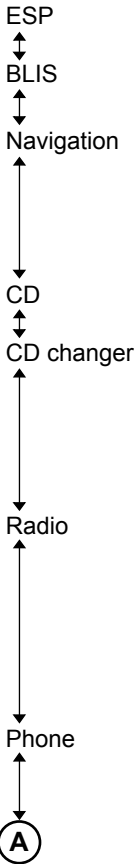

E125690

- Home
 - Destinat. mem. — Destinations
 - Destinat. A-Z — Destinations
 - Last destinat. — Destinations
 - Cancel guidan.
- Folder / Tracks
 - CD 1 — Folder / Tracks
 - CD 2 — Folder / Tracks
 - CD 3 — Folder / Tracks
 - CD 4 — Folder / Tracks
 - CD 5 — Folder / Tracks
 - CD 6 — Folder / Tracks
- Station list — Stations
 - FM 1 / FM — Stations
 - FM 2 — Stations
 - FM 3 — Stations
 - FM - AST — Stations
 - MW / AM — Stations
 - LW / AM-AST — Stations
- Phone book — Numbers
 - Redial
 - Incoming calls — Numbers
 - Outgoing calls — Numbers
 - Call status

Information displays

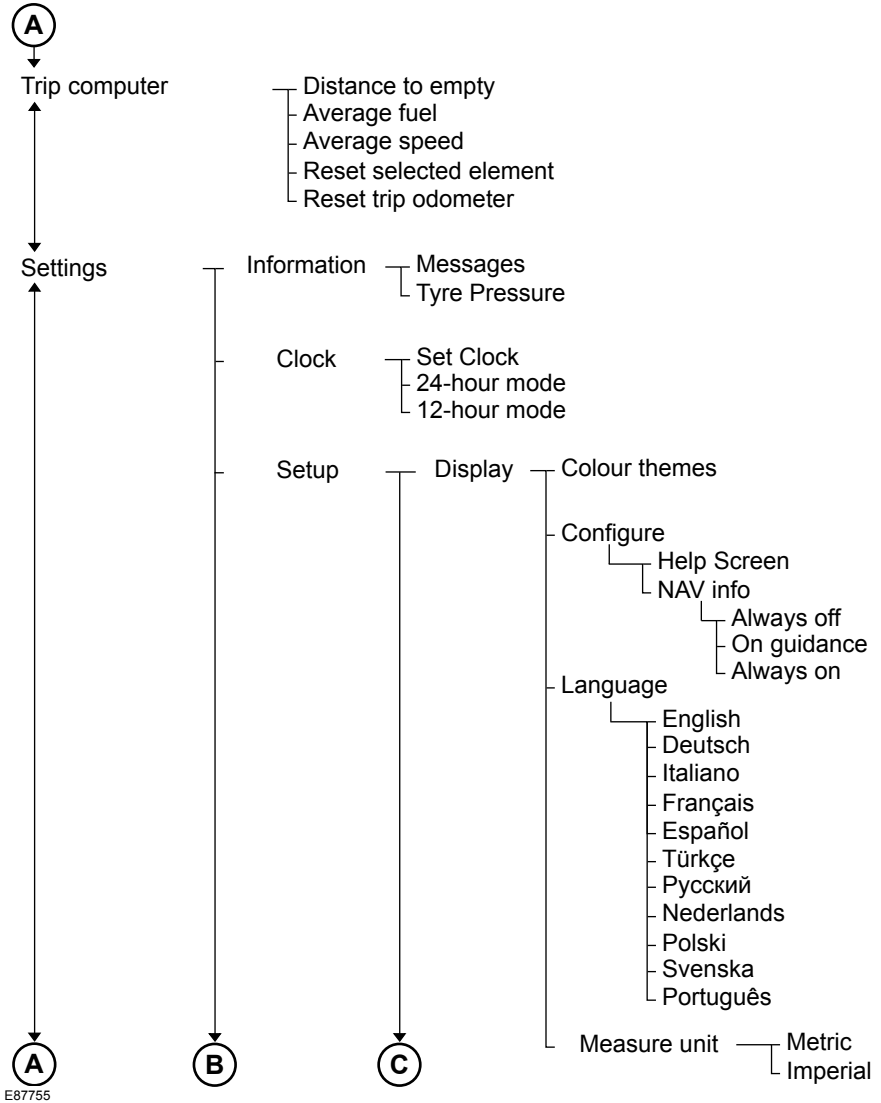

Information displays

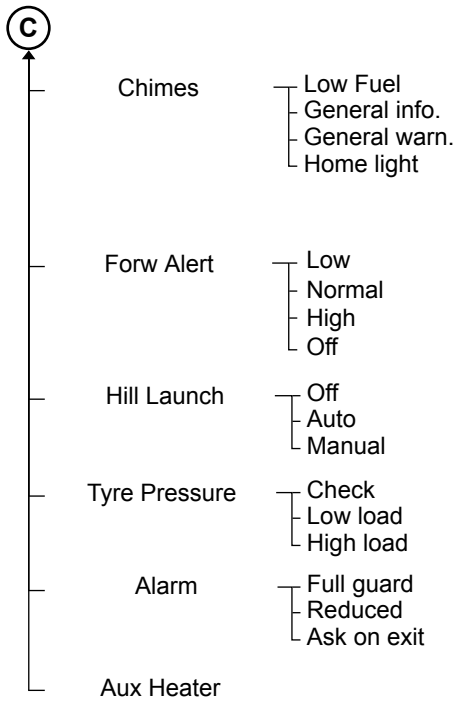

E87756

Information displays

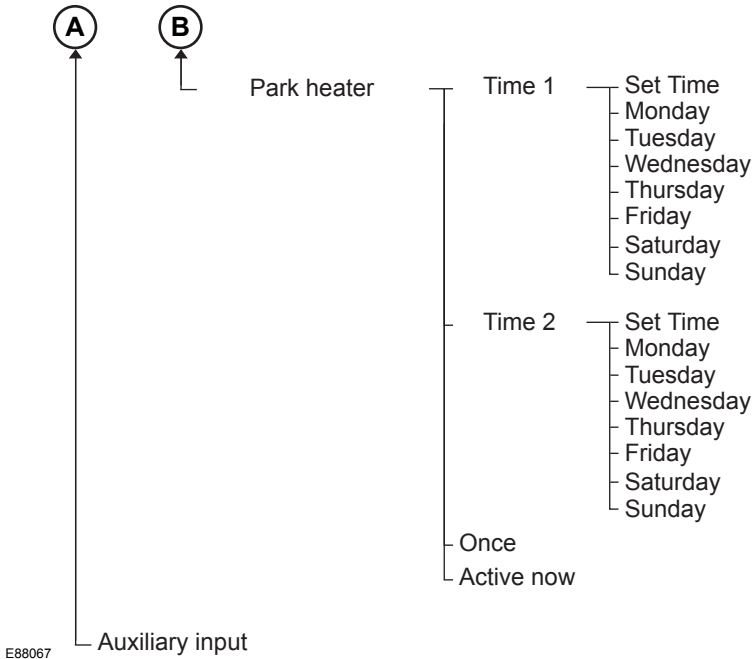

TRIP COMPUTER

Odometer

Registers the total mileage of the vehicle.

Tripmeter

Registers the mileage of individual journeys.

Distance to empty

Indicates the approximate distance the vehicle will travel on the fuel remaining in the tank. Changes in driving pattern may cause the value to vary.

Average fuel consumption

Indicates the average fuel consumption since the function was last reset.

Average speed

Indicates the average speed calculated since the function was last reset.

Outside air temperature

Shows the outside air temperature.

Information displays

Type 1 and 2

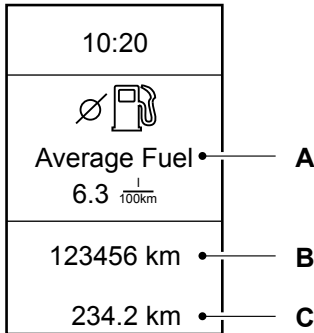

E74428

- A. Trip computer
- B. Odometer
- C. Tripmeter

The trip computer includes the following information displays:

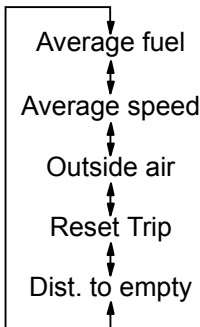

E74441

Press the **up** and **down** arrow buttons on the steering wheel to scroll through the trip computer displays.

Note: The position of the trip computer display may vary depending on the information shown in the display.

Resetting the trip computer using the main menu

To reset a particular display:

1. Press the right arrow button on the steering wheel to enter the main menu.
2. Highlight **Reset Trip** with the up and down arrow buttons and press the right arrow button.
3. Highlight the function to be reset.
4. Press the right arrow button to select the function.
5. Hold the **OK** button pressed.

To reset all three displays, select **All values** and hold the **OK** button pressed.

Type 3

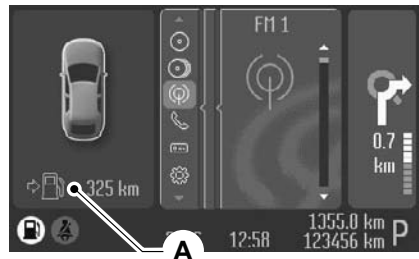

E88049

- A Trip computer

Press the **OK** button on the steering wheel to cycle through the different trip computer displays. To reset a value, press and hold the **OK** button.

Resetting the trip computer using the main menu

To reset a particular display:

1. Highlight **Trip Computer** with the up and down arrow buttons and press the right arrow button.

Information displays

2. Highlight the function to be reset.
3. Hold the **OK** button pressed.

PERSONALISED SETTINGS

The following information is displayed in the information display if you have selected it:

Help screen, radio, navigation and phone information

The help screen appears for a few seconds when you switch the ignition on.

If the radio, navigation or telephone is operating, information relating to this system is displayed in the information display.

To select which information is displayed in the information display:

Type 1 and 2

1. Press the right arrow button on the steering wheel to enter the main menu.
2. Highlight **Setup** with the up and down arrow buttons and press the right arrow button.
3. Highlight **Display** and press the right arrow button.
4. Highlight **Configure** and press the right arrow button.
5. To toggle the **Help screen**, **Radio Info** and **Phone Info** on and off, highlight the desired setting and press the **OK** button to confirm the setting.
6. Press the left arrow button to exit the menu. Hold the left arrow button pressed to return to the trip computer display.

Type 3

1. Highlight **Settings** with the up and down arrow buttons and press the right arrow button.
2. Highlight **Setup** with the up and down arrow buttons and press the right arrow button.
3. Highlight **Display** and press the right arrow button.
4. Highlight **Configure** and press the right arrow button.
5. To toggle the **Help screen** and **NAV Info** on and off, highlight the desired setting and press the **OK** button to confirm the setting.

Navigation information

You can also choose when the navigation information is displayed in the information display. Three options are available:

- **Always off:** No navigation information is displayed in the information display.
- **On guidance:** The navigation information will only appear when the navigation system provides a guidance instruction. This function is only available on certain navigation systems.
- **Always on:** Navigation information will always appear in the information display when the navigation system is operating.

To set when navigation information should be displayed:

Type 1 and 2

1. Press the right arrow button on the steering wheel to enter the main menu.
2. Highlight **Setup** with the up and down arrow buttons and press the right arrow button.

Information displays

3. Highlight **Display** and press the right arrow button.
 4. Highlight **Configure** and press the right arrow button.
 5. Highlight **Nav Info** and press the right arrow button.
 6. Highlight the desired setting and press the **OK** button to confirm the setting.
 7. Press the left arrow button to exit the menu. Hold the left arrow button pressed to return to the trip computer display.
2. Highlight **Setup** with the up and down arrow buttons and press the right arrow button.
 3. Highlight **Display** and press the right arrow button.
 4. Highlight **Language** and press the right arrow button.
 5. Highlight the desired setting and press the **OK** button to confirm the setting.
 6. Press the left arrow button to exit the menu. Hold the left arrow button pressed to return to the trip computer display.

Type 3

1. Highlight **Settings** with the up and down arrow buttons and press the right arrow button.
2. Highlight **Setup** with the up and down arrow buttons and press the right arrow button.
3. Highlight **Display** and press the right arrow button.
4. Highlight **Configure** and press the right arrow button.
5. Highlight **Nav Info** and press the right arrow button.
6. Highlight the desired setting and press the **OK** button to confirm the setting.

Language

A choice of eleven languages are available:

English, German, Italian, French, Spanish, Turkish, Russian, Dutch, Polish, Swedish and Portuguese.

Type 1 and 2

1. Press the right arrow button on the steering wheel to enter the main menu.

Type 3

1. Highlight **Settings** with the up and down arrow buttons and press the right arrow button.
2. Highlight **Setup** with the up and down arrow buttons and press the right arrow button.
3. Highlight **Display** and press the right arrow button.
4. Highlight **Language** and press the right arrow button.
5. Highlight the desired setting and press the **OK** button to confirm the setting.

Units of measure

Note: *The outside air temperature is only displayed in degrees Celsius and cannot be set to degrees Fahrenheit.*

To select metric or imperial units:

Type 1 and 2

1. Press the right arrow button on the steering wheel to enter the main menu.
2. Highlight **Setup** with the up and down arrow buttons and press the right arrow button.

Information displays

3. Highlight **Display** and press the right arrow button.
4. Highlight **Measure Unit** and press the right arrow button.
5. Highlight the desired setting and press the **OK** button to confirm the setting.
6. Press the left arrow button to return to exit the menu. Hold the left arrow button pressed to return to the trip computer display.

Type 3

1. Highlight **Settings** with the up and down arrow buttons and press the right arrow button.
2. Highlight **Setup** with the up and down arrow buttons and press the right arrow button.
3. Highlight **Display** and press the right arrow button.
4. Highlight **Measure Unit** and press the right arrow button.
5. Highlight the desired setting and press the **OK** button to confirm the setting.

INFORMATION MESSAGES



E70499

Press **OK** to acknowledge and remove some messages from the information display. Other messages will be removed automatically after a short time.

With instrument cluster type 3, certain messages need to be confirmed before you can access the menus.

Message indicator



The message indicator illuminates to supplement some messages. It will be red or amber depending on the severity of the message and will remain on until the cause of the message has been rectified.

Message symbols



See Owner's handbook.



Have the system checked at the next service.



Have the system checked as soon as possible.



Stop your vehicle as soon as it is safe to do so.

Viewing current messages

Type 1 and 2

1. Press the right arrow button on the steering wheel to enter the main menu.
2. Highlight **Information** with the up and down arrow buttons and press the right arrow button.
3. Highlight **Messages** and press the right arrow button.
4. Use the up and down buttons to view the current messages.

Type 3

1. Press the right arrow button on the steering wheel to enter the main menu.

Information displays

- Highlight **Settings** with the up and down arrow buttons and press the right arrow button.
- Highlight **Information** with the up and down arrow buttons and press the right arrow button.
- Highlight **Messages** and press the right arrow button.
- Use the up and down buttons to view the current messages.

Active suspension

Message	Message warning lamp	Meaning
IVDC malfunction	amber	The active suspension has malfunctioned. Have this checked as soon as possible. See Using active suspension (page 146).
IVDC comfort	-	The active suspension is set to the comfort setting.
IVDC normal	-	The active suspension is set to the normal setting.
IVDC sport	-	The active suspension is set to the sport setting.

Airbag

Message	Message warning lamp	Meaning
Airbag malfunction	amber	The airbag system has malfunctioned. Have this checked as soon as possible.

Alarm

Message	Message warning lamp	Meaning
Alarm triggered	amber	The alarm has been triggered. Check your vehicle for signs of unauthorised access.
Alarm system service reqd.	-	The alarm has malfunctioned. Have this checked as soon as possible.

Information displays

Battery and charging system

Message	Message warning lamp	Meaning
Overvoltage: Stop safely!	red	The charging system voltage is above its normal operating range. Stop your vehicle as soon as it is safe to do so and switch off the ignition. Have this checked as soon as possible.
Low battery	amber	The battery voltage is low. Have this checked as soon as possible.

Climate control

Message	Message warning lamp	Meaning
Aux. Heater on	amber	The auxiliary heater is on.

Cruise control and Adaptive cruise control (ACC)

Message	Message warning lamp	Meaning
Cruise control active	-	Cruise control is on.
Cruise control standby	-	Cruise control is on standby.
ACC unavailable	-	Stability control (ESP) may be switched off. Switch ESP back on and try ACC again. Otherwise try switching the ignition off and on to clear this message.
ACC malfunction	amber	The ACC has malfunctioned. Have this checked as soon as possible.
Clean radar sensor	amber	There may be something blocking the radar sensor. Clear any dirt, snow, water or other objects from the front grille area.
Forward Alert malfunction	amber	Forward alert has malfunctioned. Have this checked as soon as possible.

Information displays

Doors open

Message	Message warning lamp	Meaning
Driver door open	red	The driver side front door is open.
Driver side rear door open	red	The driver side rear door is open.
Passenger door open	red	The passenger side front door is open.
Passenger side rear door open	red	The passenger side rear door is open.
Luggage comp. open	red	The luggage compartment is open.
Bonnet open	red	The bonnet is open.

Engine immobiliser

Message	Message warning lamp	Meaning
Immobiliser active	amber	The engine immobiliser is on. See Engine immobiliser (page 42).

Hill launch assist (HLA)

Message	Message warning lamp	Meaning
Hill Launch not available	amber	HLA has malfunctioned. Have this checked as soon as possible.
Hill Launch Assist active	-	HLA is on.
Hill Launch Assist off	-	HLA is off.
Please use park brake !	amber	HLA is deactivated due to a malfunction. Use the parking brake normally on hills. See Hill start assist (page 143).

Information displays

Keyless system

Message	Message warning lamp	Meaning
Steering malfunction	red	The steering system has malfunctioned. Have this checked as soon as possible.
Key not detected	amber	A valid passive key has not been recognised.
Car operative Press STOP	amber	The engine is still running. Switch the ignition off. See Keyless starting (page 126).
Key outside car	amber	A valid passive key has not been detected inside the vehicle.
Key battery low	amber	Change the battery as soon as possible.
Steering locked - Retry	-	The steering lock is still active. Press the start button.

Lighting

Message	Message warning lamp	Meaning
Front lights malfunction	amber	The adaptive front lighting system (AFS) has malfunctioned. Have this checked as soon as possible.
Low beam: Bulb fault	-	One or both of the headlamp dipped beam bulbs have blown. Check the headlamp dipped beam bulbs. See Changing a bulb (page 59).
Rear fog light: Bulb fault	-	One or both of the rear fog lamp bulbs have blown. Check the rear fog lamp bulbs. See Changing a bulb (page 59).
Stop lamps: Bulb fault	-	One or both of the brake lamp bulbs have blown. Check the brake lamp bulbs. See Changing a bulb (page 59).
Trailer stopl.: Bulb fault	-	One or both of the brake lamp bulbs on your trailer have blown. Check the brake lamp bulbs on your trailer.
Trailer turnl.: Bulb fault	-	One or both of the direction indicator bulbs on your trailer have blown. Check the direction indicator bulbs on your trailer.

Information displays

Maintenance

Message	Message warning lamp	Meaning
Engine malfunction	red	The engine system has malfunctioned. Have this checked as soon as possible.
Check engine oil level	amber	The engine oil level is low. Check the engine oil level as soon as possible. See Engine oil check (page 210).
Water detected in fuel	amber	There is water in the fuel. Have this checked as soon as possible.
Low washer fluid level	-	The washer fluid level is low. Check the washer fluid level. See Washer fluid check (page 211).
Service oil	-	The engine oil needs to be changed. Have the engine oil changed as soon as possible.

Occupant protection

Message	Message warning lamp	Meaning
Crash mode	-	Have the system checked as soon as possible.

Parking brake

Message	Message warning lamp	Meaning
Park brake applied	amber	Release the brake when driving. Failure to do so will result in the rear brakes overheating.
Park brake applied	red	Release the brake when driving. Failure to do so will result in the rear brakes overheating.

Information displays

Power steering

Message	Message warning lamp	Meaning
Power steering malfunction	amber	The power steering system has malfunctioned. Have this checked as soon as possible.

Stability control (ESP)

Message	Message warning lamp	Meaning
ESP off	-	Stability control is off.
ESP malfunction	-	Stability control has malfunctioned. Have this checked as soon as possible.

Transmission

Message	Message warning lamp	Meaning
Transmission malfunction	red	The transmission has malfunctioned. Have this checked as soon as possible.
Transmission over-temperatur	amber	The transmission is over heating. Have this checked as soon as possible.

Tyre pressure monitoring system

Message	Message warning lamp	Meaning
Check tyre!	red	The tyre indicated has continued to deflate. Check the tyre and inflate it to the recommended pressure. See Technical specifications (page 231).
Check tyre pressures	red	One or more of the tyres are significantly under-inflated. This message may be displayed after a new sensor has been installed. Check the tyres and inflate them to the recommended pressure. See Technical specifications (page 231).

Information displays

Message	Message warning lamp	Meaning
Check tyre	amber	The tyre indicated is significantly under-inflated. Check your tyres and inflate them to the recommended pressure. See Technical specifications (page 231).
Tyre monitor malfunction	amber	You have installed a temporary spare wheel. Install a correctly inflated full size wheel with a sensor as soon as possible. When a malfunction occurs, the system may not be able to detect or signal low tyre pressure.
		Up to three sensors have malfunctioned, an unapproved accessory is interfering with the system or a general malfunction has been detected. Have the system checked as soon as possible. When a malfunction occurs, the system may not be able to detect or signal low tyre pressure.
Inflate tyres for high speed	amber	The tyre pressures are not suitable for driving at 160 km/h (100 mph). Inflate the tyres to the recommended pressure. See Technical specifications (page 231). This message will be displayed for only a few seconds with a low tyre pressure warning.
Tyre sensors not detected	-	You have installed wheels and tyres that do not have sensors. The tyre pressures will not be monitored.
		All sensors have malfunctioned or an unapproved accessory is interfering with the system. Have this checked as soon as possible.

Information displays

Voice control

Message	Message warning lamp	Meaning
Voice control Please speak	-	Voice control is on.
Voice control Not recognised	-	Check voice control.
Voice control Not allowed	-	Voice control is not allowed in this mode.

Climate control

PRINCIPLE OF OPERATION

Outside air

Keep the air intakes forward of the windscreen free from obstruction (snow, leaves etc.) to allow the climate control system to function effectively.

Recirculated air

CAUTION

! Prolonged use of recirculated air may cause the windows to mist up. If the windows mist up, follow the settings for defrosting and demisting the windscreen.

The air currently in the passenger compartment will be recirculated. Outside air will not enter the vehicle.

Heating

Heating performance depends on the temperature of the engine coolant.

Air conditioning

Note: The air conditioning operates only when the temperature is above 4°C (39°F).

Note: If you use the air conditioning, the fuel consumption of your vehicle will be higher.

Air is directed through the evaporator where it is cooled. Humidity is extracted from the air to help keep the windows free of mist. The resulting condensation is directed to the outside of the vehicle and it is therefore normal if you see a small pool of water under your vehicle.

General information on controlling the interior climate

Fully close all the windows.

Warming the interior

Direct the air towards your feet. In cold or humid weather conditions, direct some of the air towards the windscreen and the door windows.

Cooling the interior

Direct the air towards your face.

AIR VENTS

Front air vents



E71942

Rear air vents

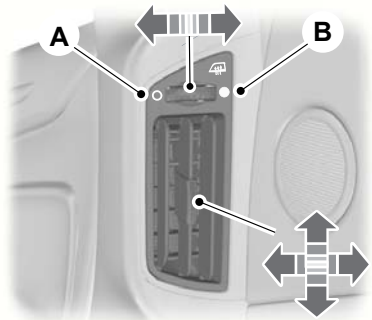

E89129

- A Open
- B Close

Climate control

MANUAL CLIMATE CONTROL

Air distribution control

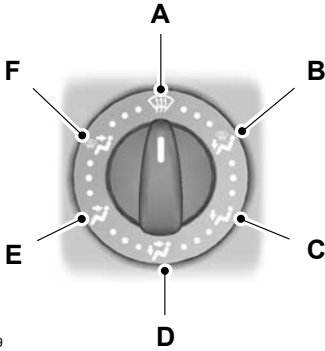

E71379

- A Windscreen
- B Footwell and windscreen
- C Footwell
- D Face level and footwell
- E Face level
- F Face level and windscreen

You can set the air distribution control to any position between the symbols.

Blower

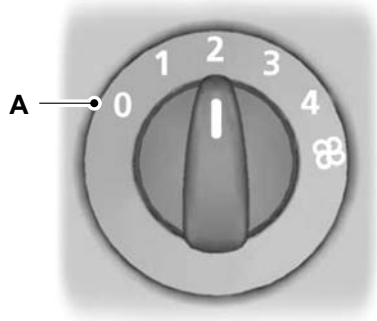

E75470

- A Off

Note: If you switch the blower off, the windscreen may mist up.

Recirculated air



Press the button to toggle between outside air and recirculated air.

Heating the interior quickly



E71377

Climate control

Ventilation



E71378

Set the air distribution control, blower and air vents to suit your requirements.

Air conditioning

Switching the air conditioning on and off



If you turn the blower off, the air conditioning will turn off. When you turn the blower on again, the air conditioning will come on automatically.

Cooling with outside air

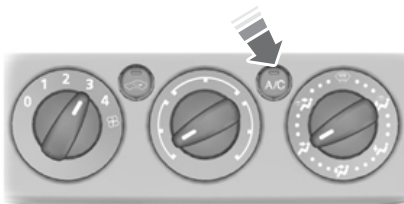

E71380

Cooling the interior quickly

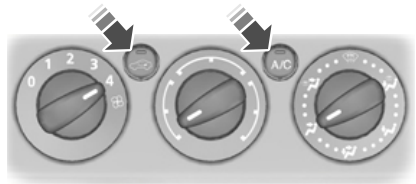

E71381

Defrosting and demisting the windscreen

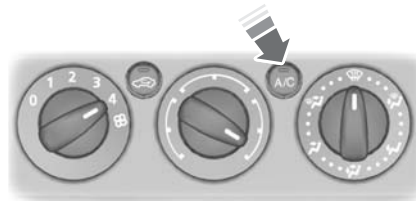

E71382

When the temperature is above 4°C (39°F), the air conditioning will switch on automatically. Make sure that the blower is on. The indicator in the switch will illuminate during defrosting and demisting.

If you move the air distribution control to a position other than **A**, the **A/C** will remain on.

You can switch the air conditioning and recirculated air on and off while the air distribution control is set to position **A**.

If necessary, switch the heated windows on. See **Heated windows and mirrors** (page 105).

Climate control

Reducing interior air humidity

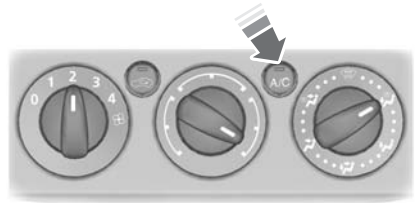

E71383

AUTOMATIC CLIMATE CONTROL



E80737

The system controls the temperature, amount and distribution of the air flow automatically and adjusts them according to the driving and weather conditions. Press the **AUTO** button to switch auto mode on.

The system in your vehicle is dual-zone automatic climate control. When the system is in mono mode, all the temperature zones are linked to the driver's zone. When you switch mono mode off, the dual-zone system allows you to set different temperatures for the driver's and front passenger's side.

Note: Avoid adjusting the settings when the vehicle interior is extremely hot or cold. The automatic climate control adjusts to the current circumstances automatically. For the system to function properly, the side and centre vents should be fully open.

Note: At low outside temperatures, when the system is in auto mode, the air stream will be directed to the windscreen and the side windows as long as the engine is cold.

Climate control

Note: For information on the automatic climate control, on vehicles fitted with a combined Navigation and automatic climate control system, see separate handbook.

Setting the temperature



E70304

You can set the temperature between 16°C (61°F) and 28°C (82°F) in steps of 0.5°C (1°F). In position **LO** (below 16°C [61°F]) the system will switch to permanent cooling, in position **HI** (above 28°C [82°F]) to permanent heating, and will not regulate a stable temperature.

Mono mode

In mono mode, the temperature settings for both the driver's and passenger's side are linked. If you adjust the temperature using the rotary control on the driver's side, the same temperature will be set for the passenger's side. **MONO** is shown in the display.

To switch mono mode off

Select a temperature for the passenger's side using the rotary control on the passenger's side. Mono mode will switch off and **MONO** disappears from the display. The temperature for the driver's side will remain unchanged. You can now adjust the driver's and passenger's side temperatures independently of each other. The temperatures are shown in the display. You can set a difference of up to 4°C (7°F).

Note: If you set a difference of greater than 4°C (7°F), the temperature on the other side will be adjusted so that the difference remains at 4°C (7°F).

Note: If you set one of the sides to **HI** or **LO**, both sides will be set to **HI** or **LO**.

To switch mono mode back on



Press the **MONO** button. **MONO** is shown in the display, and the passenger's side temperature will be adjusted to the driver's side temperature.

Blower

High speed



Low speed



Use the buttons to adjust the blower speed.

The blower setting is shown in the display.



To return to auto mode, press the **AUTO** button.

Air distribution

To adjust air distribution, press the desired button. Any combination of settings can be selected simultaneously.

Climate control

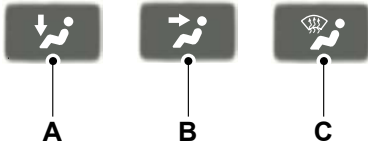

E70308

- A Footwell
- B Face level
- C Windscreen

Windscreen defrosting and demisting



When you select windscreen defrosting and demisting, **A**, **B** and **C** switch off automatically and the air conditioning switches on. Outside air will flow into the vehicle. You cannot select recirculated air.

The blower speed and the temperature control operate automatically and cannot be adjusted manually. The blower is set to high speed and the temperature to **HI**.

When you select windscreen defrosting and demisting, the heated screens switch on automatically and switch off after a short time.

To return to auto mode, press the **AUTO** button.

Note: To defrost or demist the rear side windows, adjust the rear air vents. See **Air vents** (page 100).

Switching the air conditioning on and off



Press the button. **A/C OFF** or **A/C ON** is shown in the display.

Recirculated air



Press the button to change between automatic mode and recirculated air.

Note: When the system is in auto mode and the interior and exterior air temperatures are quite hot, the system selects recirculated air automatically to maximise cooling of the interior. Once the selected temperature is reached, the system will automatically reselect automatic mode.

Switching the automatic climate control on and off



E70980

Use the buttons to switch the system on and off.

When switched off, the heating, ventilation and air conditioning system is switched off and recirculated air is selected.

HEATED WINDOWS AND MIRRORS

Heated windows

Use the heated windows to defrost or demist the windscreen or rear window.

Note: The heated windows operate only when the engine is running.

Climate control

Heated windscreen



Heated rear window



Heated exterior mirrors

Electric exterior mirrors are fitted with a heating element that will defrost or demist the mirror glass. They will switch on automatically when you switch the heated rear window on.

AUXILIARY HEATER

Parking heater

WARNING



The parking heater must not be operated at filling stations, near sources of combustible vapours or dust or in enclosed spaces.

The parking heater operates independently of the vehicle heater by heating the engine's coolant circuit. It is fed from the vehicle fuel tank. You can also use it while the vehicle is in motion to help the vehicle heater warm up the interior more quickly.

Used properly, the parking heater provides the following benefits:

- It preheats the interior of the vehicle.
- It keeps the windows clear of ice in the event of frost and prevents condensation.
- It avoids cold starts and allows the engine to reach operating temperature sooner.

Note: The parking heater will only operate if there is at least 7.5 litres (1.6 gallons) of fuel in the fuel tank and the ambient temperature is below 15°C (59°F). The heater will not operate if the battery is low.

Note: The heating depends on the outside air temperature.

Note: When the parking heater is activated, exhaust fumes may come from under the sides of the vehicle. This is normal.

Note: On vehicles with a manual heating, ventilation and air conditioning system, the heating of the vehicle interior is dependent on the temperature, air distribution and blower control settings.

To prevent the battery from discharging:

- Once the parking heater has performed one heating cycle, the next programmed heating cycle will only be carried out if you have started the vehicle's engine in between.
- After a heating cycle, drive the vehicle for at least the period of the heating cycle.

Programming the parking heater

Note: The programmed time is the time at which you wish the vehicle to be warm and ready to drive, not the time at which the heater switches on.

Note: You must programme the times at least 70 minutes in advance of the time you wish to set.

Note: You must set the time and date correctly. See **Clock** (page 120).

To programme the heating times:

Climate control



E70499

1. Press the right arrow button on the steering wheel to enter the main menu.
2. Highlight **Setup** with the up and down arrow buttons and press the right arrow button.
3. Highlight **Park Heater** and press the right arrow button.

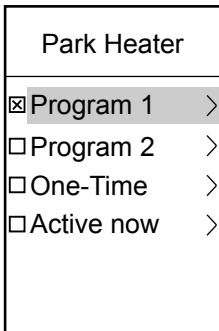

E74467

- The functions **Program 1** and **Program 2** allow you to programme up to two heating cycles for each day of the week. These times will remain stored and the heater will warm up the vehicle at these times on these days every week.
- The function **One-Time** allows you to programme one heating cycle for one specific day.
- The function **Active now** automatically switches on the heater.

Programming the functions Program 1 and Program 2

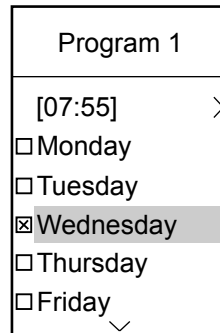

E74468

1. Highlight **Program 1** and press the right arrow button.
2. Highlight the day on which the heater should warm up the vehicle.
3. Press the **OK** button to confirm the selection. A cross appears in the box next to the day to show that this day is selected.
4. Continue in the same way to select all the days on which the heater should warm up the vehicle.

Climate control

- To set the time at which the vehicle should be warmed up, highlight the time at the top of the display and press the right arrow button.
- Press the **OK** button and the hours flash. Use the up and down arrow buttons to adjust the individual settings and the left and right arrow buttons to move to the next or previous setting.
- When you have finished, press the **OK** button again to confirm the selection.

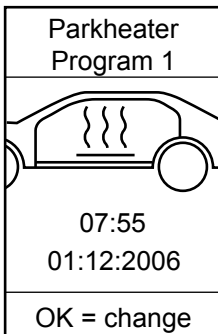

E74469

You can use the function **Program 2** to set a second cycle, for example different times on different days or twice on the same day. The programming procedure is the same as for the function **Program 1**.

Programming the function One-Time

- Highlight **One-Time** and press the right arrow button.
- Press the **OK** button and the hours flash. Use the up and down arrow buttons to adjust the individual settings and the left and right arrow buttons to move to the next or previous setting.
- When you have finished, press the **OK** button again to confirm the selection.

Active now

Highlight **Active now** and press the **OK** button. A cross appears in the box next to the function to show that the heater is activated.

To deactivate the heater, highlight **Active now** and press the **OK** button again.

Remote starting

The parking heater may be started and switched off from a distance of up to 500 metres (1640 feet) using the supplied remote control transmitter. This range will vary depending upon local conditions and terrain, as well as battery condition. The remote control transmitter will indicate whether or not the signal has been received. The parking heater will operate for a maximum of 30 minutes.

Note: *The heater will operate, depending on the ambient temperature, for between 10 and 30 minutes. The interior will cool down after the heating period has elapsed, therefore a remote start more than 30 minutes before driving is not recommended.*

Note: *The remote control may not always receive confirmation of a successful remote command at extended operating ranges.*

Starting

Hold the transmitter with the antenna upwards and press the ON button for at least two seconds. The LED on the transmitter lights up green to confirm the signal has been received.

Switching off

Hold the transmitter with the antenna upwards and press the OFF button for at least two seconds. The LED on the transmitter lights up red to confirm the signal has been received.

Climate control

Remote start in combination with direct start or timer

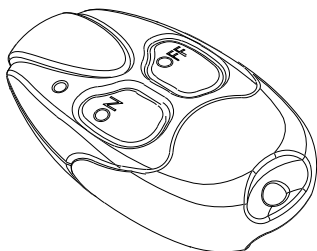

E114360

Remote start is integrated with normal heater control. Parking heaters started with direct start or timer functions can be switched off with the remote control transmitter and vice versa.

Feedback during starting and switching off

The LED on the transmitter illuminates green for about two seconds. This indicates the signal has been received by the vehicle and the heater has started.

The LED on the transmitter illuminates red for about two seconds. This indicates the signal has been received by the vehicle and the heater has switched off.

The LED on the transmitter flashes green or red for about two seconds. This indicates the signal was not transmitted correctly. Repeat the transmission.

The LED on the transmitter illuminates orange for about two seconds before showing green or red. This indicates the transmitter batteries are weak and should be changed.

The LED on the transmitter flashes orange for about 5 seconds. This indicates that the signal was not transmitted. The transmitter batteries are discharged and should be changed as soon as possible.

Changing the remote control battery

Make sure that you dispose of old batteries in an environmentally friendly way. Seek advice from your local authority regarding recycling.

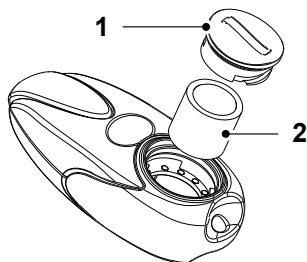

E114361

1. Insert a screwdriver or other suitable tool into the slot on the back of the remote control, and unscrew the compartment cover.

CAUTION



Do not touch the battery contacts or the printed circuit board with the screwdriver.

2. Carefully prise out the battery.
3. Install a new battery (3.3V type CR1-3N) with the + facing upwards.
4. Re-assemble the remote control.

Programming the transmitter

Further transmitters may be used with the remote system, please consult your dealer. Up to a maximum of 3 separate remote controls may be added. When adding extra transmitters these must be programmed separately.

Note: *The heater must be switched off during programming.*

Climate control

Note: The programming procedure may be repeated as often as is required. The oldest programmed transmitter will be deleted each time.

1. Install the battery in the new transmitter.
2. Turn off the power to the receiver by removing fuse F32 from the engine compartment fuse box. See **Fuse specification chart** (page 186).
3. Wait for at least 5 seconds.
4. Reconnect power to the receiver by replacing the fuse, and press the OFF button on the new transmitter within 5 seconds until the LED light turns off.
5. The new transmitter is now programmed.

Fuel operated heater (depending on country)

WARNING



The fuel operated heater must not be operated at filling stations, near sources of combustible vapours or dust or in enclosed spaces.

The fuel operated heater aids in warming the engine and the vehicle interior on vehicles with a diesel engine. It is switched on or off automatically depending on the outside air temperature and the coolant temperature, unless you have deactivated it. When the fuel operated heater is operating, **Aux. Heater on** is displayed in the information display. See **Information displays** (page 78).

To deactivate the fuel operated heater:



E70499

1. Press the right arrow button on the steering wheel to enter the main menu.
2. Highlight **Setup** with the up and down arrow buttons and press the right arrow button.
3. Highlight **Aux. Heater** and press the **OK** button to toggle the heater on and off. A cross appears in the box when the heater is activated.
4. Press the left arrow button to exit the menu. Hold the left arrow button pressed to return to the trip computer display.

Diesel auxiliary heater (depending on country)

The diesel auxiliary heater (PTC electrical heater) aids in warming the vehicle interior on vehicles with a diesel engine. It is switched on or off automatically depending on the outside air temperature, the coolant temperature and the alternator load.

Climate control

ELECTRIC SUNROOF

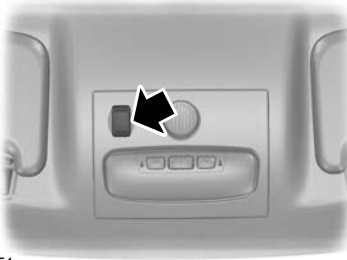

E78054

WARNING



Before operating the electric sunroof you should verify it is free of obstructions and ensure that children and/or pets are not in the proximity of the sunroof opening. Failure to do so could result in serious personal injury. It is the primary responsibility of the supervising adults to never leave a child unattended in a vehicle and to never leave the keys in an unattended vehicle.

Note: When the switches are operated often during a short period of time, the system might become inoperable for a certain time to prevent damage due to overheating.

Note: The electric sunroof can also be operated with the ignition off via the global opening and global closing function. See **Global opening and closing** (page 37).

There are two ways of opening the sunroof – the rear of the sunroof lifts open or the sunroof opens from the front, sliding back under the roof. The sunroof opens and closes whilst the switch is pressed.

Switch on the ignition to operate the electric sunroof.

The power sunroof is operated by a switch located between the sun visors.

Opening and closing the sunroof

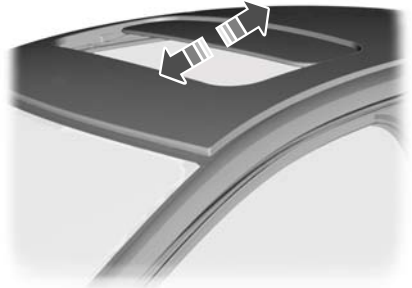

E72188

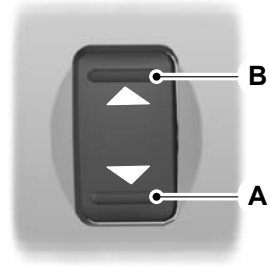

E72185

- A Press to close
- B Press to open

Climate control

Tilting the sunroof

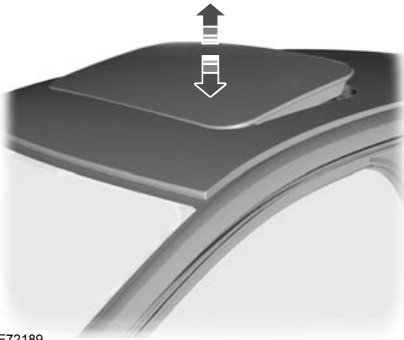

E72189

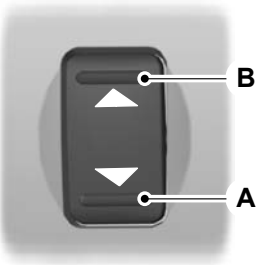

E72185

- A Press to open
- B Press to close

Opening and closing the sunroof automatically

Note: When opening automatically, the sunroof will stop about 8 cm from the fully opened position. This position reduces the buffeting noise which is sometimes heard when the sunroof is fully open. The sunroof will only stop automatically in this position when the sunroof is opened automatically.

To open or close the sunroof automatically press either side of the switch to the second action point and release it completely. Press again to stop.

When the closed position is reached, the sunroof stops automatically.

Sunroof anti-trap protection

WARNINGS



The anti-trap function is deactivated until the memory has been reset. Careless closing of the window can cause injuries.



Careless closing of the electric sunroof can override the anti-trap protection and cause injuries.

The sunroof will stop automatically while closing and reverse some distance if there is an obstacle in the way.

To override anti-trap protection when there is a resistance, e. g. in the winter, proceed as follows:

WARNING



While the sunroof is being closed for the third time, the anti-trap function is disabled. Make sure there are no obstacles in the way of the closing sunroof.

Close the sunroof a third time to the resistance. The anti-trap function is disabled and the sunroof cannot be closed automatically. The sunroof will override the resistance and can then be closed fully.

If the sunroof does not close after the third attempt, have it checked by an expert.

Sunroof safety mode

WARNING



The anti-trap function is not active during this procedure. Make sure that there are no obstacles in the way of the closing sunroof.

If the system detects a malfunction, it enters a safety mode. The sunroof will move for only about 0.5 seconds at a time and then stop again. Close the sunroof by pressing the button again when the sunroof stops moving. When the rear of the sunroof is lifted, lift the rear all the way and then close the sunroof. Have the system checked by an expert immediately.

Sunroof relearning

WARNING



The anti-trap function is not active during this procedure. Make sure that there are no obstacles in the way of the closing sunroof.

In case the sunroof no longer closes properly, follow this relearning procedure:

- Tilt the rear of the sunroof as far as possible. Release the button.
- Press and hold the same button again for 30 seconds until you see the sunroof move.
- Release the button and immediately press and hold it again. The sunroof will close, open fully and then close again. Do not release the button before the sunroof has reached the closed position for the second time.

If the button is not pressed continuously, the relearning function will be interrupted. Start the procedure once more from the beginning.

Seats

SITTING IN THE CORRECT POSITION

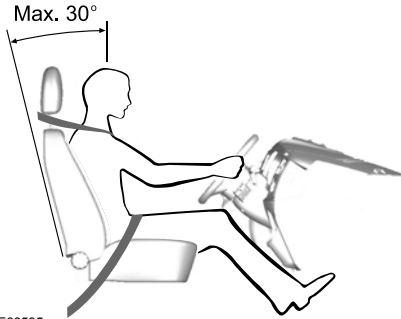

E68595

WARNINGS



Do not adjust the seats when the vehicle is moving.



Only when you use the seat belt properly, can it hold you in a position that allows the airbag to achieve its optimum effect.

When you use them properly, the seat, head restraint, seat belt and airbags will provide optimum protection in the event of a collision. We recommend that you:

- sit in an upright position with the base of your spine as far back as possible.
- do not recline the seatback more than 30 degrees.
- adjust the head restraint so that the top of it is level with the top of your head and as far forwards as possible, remaining comfortable.
- keep sufficient distance between yourself and the steering wheel. We recommend a minimum of 250 millimetres (10 inches) between your breastbone and the airbag cover.

- hold the steering wheel with your arms slightly bent.
- bend your legs slightly so that you can press the pedals fully.
- position the shoulder strap of the seat belt over the centre of your shoulder and position the lap strap tightly across your hips.

Make sure that your driving position is comfortable and that you can maintain full control of your vehicle.

MANUAL SEATS

Moving the seats backwards and forwards

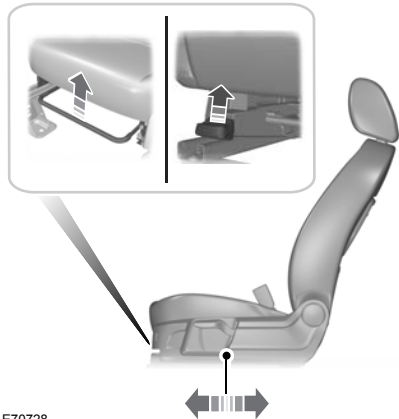

E70728

WARNING



Rock the seat backwards and forwards after releasing the lever to make sure that it is fully engaged in its catch.

Seats

Adjusting the lumbar support



E70729

Adjusting the height of the driver's seat

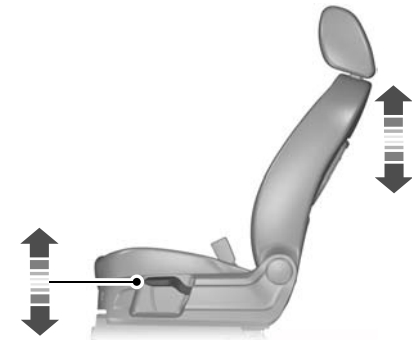

E70730

Adjusting the angle of the seatback

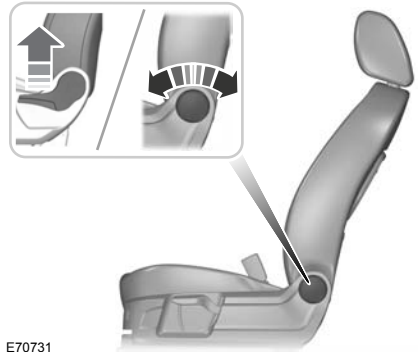

E70731

ELECTRIC SEATS

2-way electric seat

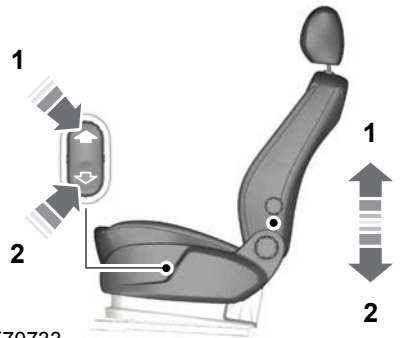

E70733

Seats

8-way electric seat

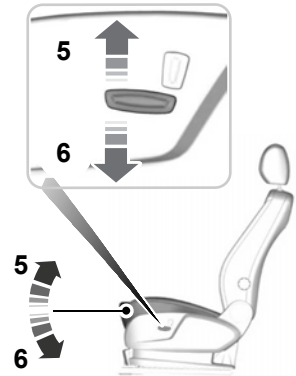
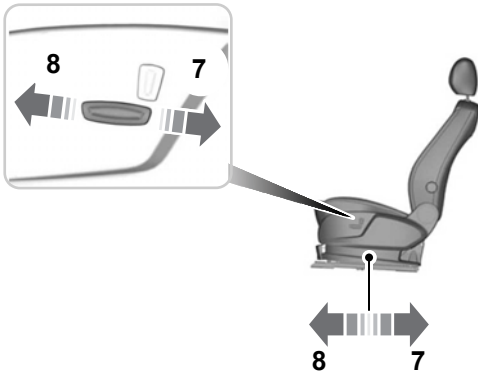
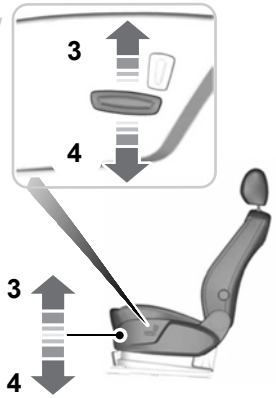
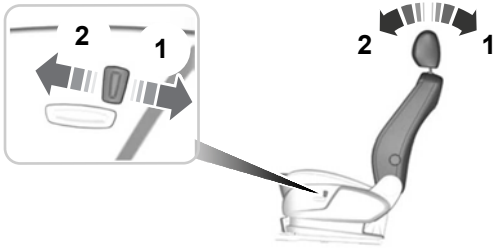

E70734

Seats

HEAD RESTRAINTS

Adjusting the head restraint

WARNINGS



Raise the rear head restraint when the rear seat is occupied by a passenger.



When using a forward facing child restraint on a rear seat, always remove the head restraint from that seat.

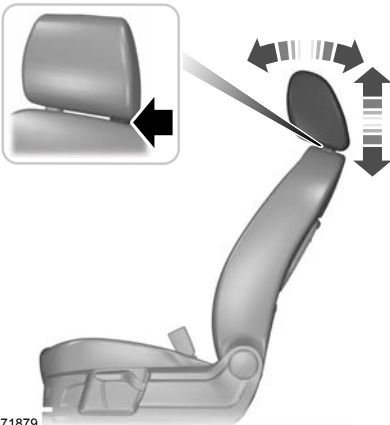

E71879

Adjust the head restraint so that the top of it is level with the top of your head and as far forwards as possible, remaining comfortable.

Removing the head restraint

Press the locking buttons and remove the head restraint.

REAR SEATS

WARNINGS



When folding the seatbacks down, take care not to get your fingers caught between the seatback and seat frame.



Make sure that the seats and the seatbacks are secure and fully engaged in their catches.

Folding the seatbacks down

CAUTION



Lower the head restraints.



E86611

1. Press the unlock buttons down and hold them there.
2. Push the seatback forwards.

Creating a level load floor

WARNING



Make sure the red indicator is not showing when you engage the seat in the catches.

Seats

CAUTION

 Lower the head restraints.

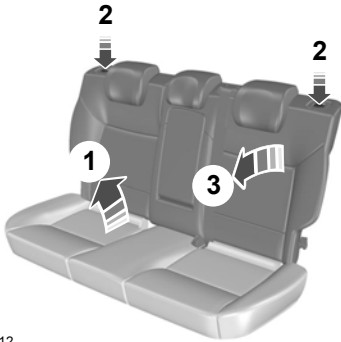

E86612

1. Insert your fingers between the seat cushion and seatback and fold the seat cushion forwards.
2. Press the unlock buttons down and hold them there.
3. Push the seatback forwards.

Folding the seatbacks up

WARNING

 When folding the seatbacks up, make sure that the belts are visible to an occupant and not caught behind the seat.

HEATED SEATS

CAUTION

 Operating this function with the engine off will drain the battery.



E70601



E71224

Note: *The settings are stored when you switch off the ignition.*

VENTILATED SEATS

CAUTION

 Operating this function with the engine off will drain the battery.

Seats



E70601

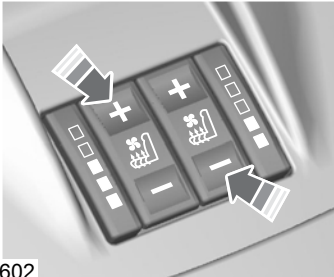

E70602

Note: The settings are stored when the ignition is switched off.

Note: When the seat is being ventilated, the heater may switch on automatically. This is to prevent the flow of air becoming uncomfortably cool.

Note: The air in the vehicle interior is used to ventilate the seats. The cooling effect therefore depends on the temperature of the vehicle interior. Switch on the air conditioning if necessary and set the air distribution to footwell. See **Climate control** (page 100).

Convenience features

SUN BLINDS

Pull the blind up and attach it to the hooks (A).

Side windows

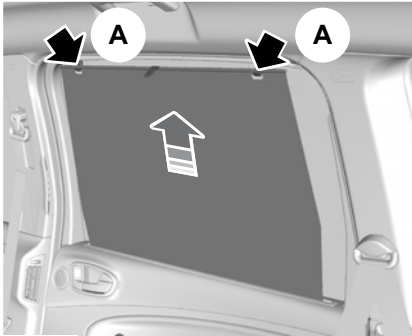

E74809

Rear window



E86514

INSTRUMENT LIGHTING DIMMER



E70723

CLOCK

Note: Some navigation systems will automatically set the date and time on the clock using GPS signals.

Note: See **General information** (page 78).

1. From the main menu, select the clock function.
2. Select the option required.
3. Press **OK**.
4. Using the right, left, up and down arrow buttons, select and change the value.
5. Press **OK**.

CIGAR LIGHTER

CAUTIONS

- ! If you use the socket when the engine is not running, the battery may discharge.
- ! Do not hold the cigar lighter element pressed in.

Convenience features

Note: Switch the ignition on to use the cigar lighter. You can also use it for up to 30 minutes after you have switched the ignition off.

Note: You can use the socket to power 12 volt appliances that have a maximum current rating of 15 Amperes. Use only Ford accessory connectors or connectors specified for use with SAE standard sockets.

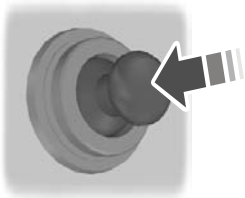

E72972

Press the element in to use the cigar lighter. It will pop out automatically.

ASHTRAY

Front ashtray

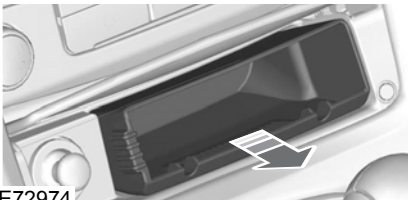

E72974

To empty, pull out the complete ashtray.

Rear ashtray



E73705

To remove the ashtray, open it, press it down against the spring and remove it.

AUXILIARY POWER SOCKETS

CAUTION



If you use the socket when the engine is not running, the battery may discharge.

Note: You can use the socket when the ignition is switched off.

Note: You can use the socket to power 12 volt appliances that have a maximum current rating of 15 Amperes. Use only Ford accessory connectors or connectors specified for use with SAE standard sockets.

Convenience features



E86470

STORAGE COMPARTMENTS

WARNING

 Do not drive with any storage compartment lid open. Make sure that you secure the lid before setting off.

CAUTION

 Do not keep heat-sensitive items and liquids in any storage compartment.

CUP HOLDERS

WARNING

 Do not place hot drinks in the cup holders when the vehicle is moving.

GLOVE BOX

Cooled glove box

Note: You can cool the glove box using air from the air conditioning system.

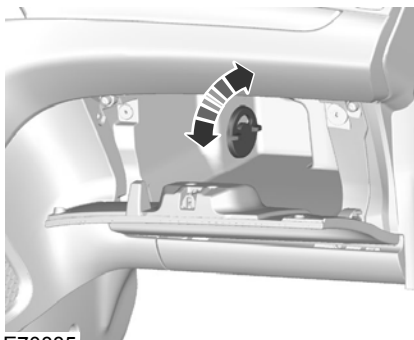

E70885



E73704



E72905

Convenience features

MAP POCKETS

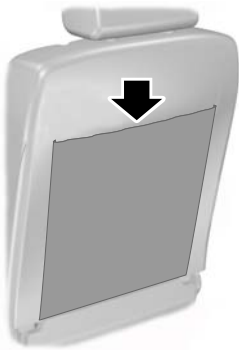

E74686

MEMORY FUNCTION

WARNINGS



Before activating the seat memory, make sure that the area immediately surrounding the seat is clear of obstructions and that all occupants are clear of moving parts.



Do not use the memory store function when the vehicle is moving.

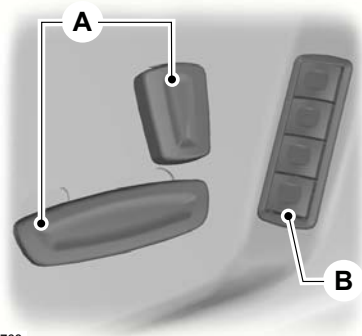

E86768

A Seat adjustment controls. See **Electric seats** (page 115).

B Memory pre-set buttons

Up to four different driver's seat and exterior mirror positions can be stored in the memory. Your preferred setting for the reverse mirror dipping feature can also be stored. See **Electric exterior mirrors** (page 70).

Setting a memory pre-set

Passive setting

The vehicle stores the seating and mirror positions for up to four remote controls or passive keys. Next time the vehicle is unlocked, the position of the seat and mirrors will adjust to the last used position.

Each time you turn the ignition off, the current seat and mirror settings are stored on the remote control or passive key used.

Active setting

1. Turn the ignition on.
2. Adjust the seat and exterior mirrors to the desired position.

Convenience features

3. Press and hold the desired pre-set button **B** until a single chime sounds to confirm.

Recalling a stored seat position

Note: To stop seat movement during a recall, press any driver seat adjustment control, any of the memory buttons or any mirror control switch. Seat movement will also stop if you move the vehicle.

Passive recall

Note: If more than one passive key is in range, the memory function will move to the settings of the first key stored.

When you unlock the vehicle with the remote control or pull the driver door handle with a passive key in range, the seat and mirrors will move to the position stored on that remote control or passive key.

Active recall

Press the pre-set button associated with the desired driving position. The seat and mirrors will move to the position stored on that pre-set.

GLASSES HOLDER

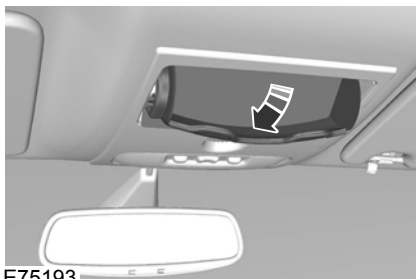

E75193

CD CHANGER

This is located in the luggage compartment.

AUXILIARY INPUT (AUX IN) SOCKET

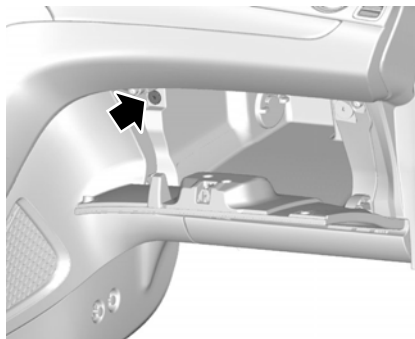

E71969

See separate audio handbook.

Convenience features

USB PORT

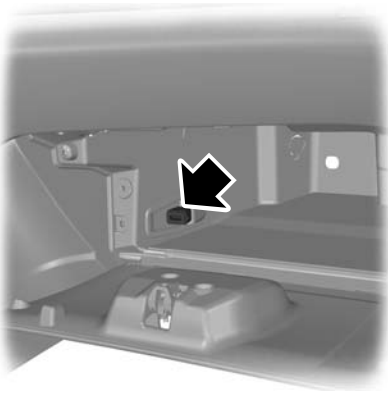

E104423

See **Connectivity** (page 268).

FLOOR MATS

WARNING



When using the floor mats, always make sure the floor mat is properly secured using the appropriate fixings and positioned so that it does not interfere with the operation of the pedals.

Starting the engine

GENERAL INFORMATION

General points on starting

If the battery has been disconnected the vehicle may exhibit some unusual driving characteristics for approx. 8 kilometres (5 miles) after reconnecting the battery.

This is because the engine management system must realign itself with the engine. Any unusual driving characteristics during this period may be disregarded.

Starting the engine by towing or pushing

WARNING



To prevent damage you must not push or tow start your vehicle. Use booster cables and a booster battery. See **Using booster cables** (page 217).

IGNITION SWITCH

WARNING



Never return the key to position **O** or **I** when the vehicle is in motion.



E72128

O The ignition is off.

I The ignition and all main electrical circuits are disabled.

Note: Do not leave the ignition key in this position for too long to avoid discharging the battery.

II The ignition is switched on. All electrical circuits are operational. Warning lamps and indicators illuminate. This is the key position when driving. You must also select it when being towed.

III The starter motor is activated. Release the key as soon as the engine starts.

KEYLESS STARTING

WARNINGS



The keyless starting system may not function if the key is close to metal objects or electronic devices such as mobile phones.



Always check that the steering wheel lock is deactivated before attempting to move your vehicle. See **Steering wheel lock** (page 128).

Note: A valid passive key must be located inside the vehicle to switch the ignition on and start the engine.

Note: To start your engine you must also fully depress the brake or clutch pedal, depending on the transmission fitted.



E85766

Ignition on

Press the start button once. All electrical circuits are operational, warning lamps and indicators illuminate.

Starting the engine

Starting with automatic transmission

Note: Releasing the brake pedal during engine start will stop the engine cranking and return to ignition on.

1. Make sure the transmission is in **P** or **N**.
2. Fully depress the brake pedal.
3. Press the start button.

Starting with manual transmission

Note: Releasing the clutch pedal during engine start will stop the engine cranking and return to ignition on.

1. Fully depress the clutch pedal.
2. Press the start button.

Starting a diesel engine

Note: Engine cranking may not commence until the engine glow plug cycle has been completed. This may take several seconds in extremely cold conditions.

Note: Continue to press the clutch or brake pedal until engine cranking begins.

Failure to start

The passive starting system will not function if:

- The passive key frequencies are jammed.
- The passive key battery is flat.

If you are unable to start your vehicle carry out the following procedure.

Type 1



E87382

1. Hold the key next to the steering column shroud exactly as shown.
2. With the key in this position you can use the start button to switch the ignition on and start your vehicle.

Type 2

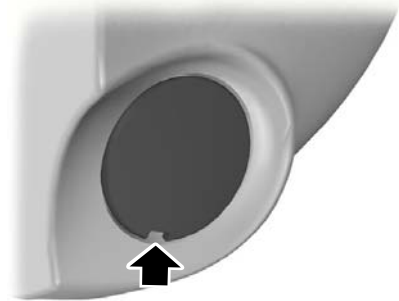

E87381

1. Carefully prise out the cover.

Starting the engine

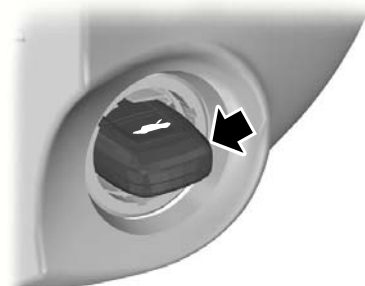

E85767

2. Insert the key into the key holder.
3. With the key in this position you can use the start button to switch the ignition on and start your vehicle.

Stopping the engine

When your vehicle is stationary, press the start button to stop the engine. The ignition, all electrical circuits, warning lamps and indicators will be switched off.

STEERING WHEEL LOCK

WARNING



Always check that the steering is unlocked before attempting to move your vehicle.

Vehicles without keyless starting

To activate the steering wheel lock;

1. Remove the key from the ignition switch.
2. Turn the steering wheel.

Vehicles with keyless starting

Note: *The steering wheel lock will not activate when the ignition is on or the vehicle is moving.*

Your vehicle has an electronically controlled steering wheel lock. This operates automatically.

The steering wheel lock will activate after a short period of time once you have parked your vehicle and the passive key is outside of the vehicle.

Deactivating the steering wheel lock

Switch the ignition on, or:

Vehicles with automatic transmission

- Press the brake pedal.

Vehicles with manual transmission

- Press the clutch pedal.

STARTING A PETROL ENGINE

Note: *You can only operate the starter for a maximum of 30 seconds at a time.*

Cold or hot engine

All vehicles

CAUTION



When the temperature is below -20°C (-4°F), switch the ignition on for at least one second before starting the engine. This will make sure that the maximum fuel pressure is established for starting the engine.

Vehicles with manual transmission

Note: *Do not touch the accelerator pedal.*

1. Fully depress the clutch pedal.

Starting the engine

2. Start the engine.

Vehicles with automatic transmission

Note: *Do not touch the accelerator pedal.*

1. Select park or neutral.
2. Fully depress the brake pedal.
3. Start the engine.

All vehicles

If the engine does not start within 15 seconds, wait for a short period and try again.

If the engine does not start after **three** attempts, wait 10 seconds and follow the **Flooded engine** procedure.

If you have difficulty starting the engine when the temperature is below -25°C (-13°F), press the accelerator pedal between $\frac{1}{4}$ to $\frac{1}{2}$ of its travel and try again.

Flooded engine

Vehicles with manual transmission

1. Fully depress the clutch pedal.
2. Fully depress the accelerator pedal and hold it there.
3. Start the engine.

Vehicles with automatic transmission

1. Select park or neutral.
2. Fully depress the accelerator pedal and hold it there.
3. Fully depress the brake pedal.
4. Start the engine.

All vehicles

If the engine does not start, repeat the **Cold or hot engine** procedure.

Engine idle speed after starting

The speed at which the engine idles immediately after starting will vary depending on the engine temperature.

If the engine is cold then the idle speed will automatically be increased in order to heat the catalytic converter as quickly as possible. This ensures that vehicle emissions are kept to an absolute minimum.

The idle speed will slowly decrease to the normal level as the catalytic converter warms up.

STARTING A PETROL ENGINE - E85

For general information on starting a petrol engine. See **Starting a petrol engine** (page 128).

Starting at low ambient temperatures

When the temperature is lower than -10°C (14°F) and the vehicle is filled with E85, an engine block heater should be used to facilitate starting. See **Engine heater** (page 131). Failure to do this will result in a non start.

If the temperature is expected to remain below -10°C (14°F), it is recommended that you increase the proportion of petrol in the tank by topping up with 95 octane unleaded petrol if the tank is not already full. About 10 litres (2.2 gallons) of petrol will reduce the proportion of E85 in a $\frac{3}{4}$ full tank from 85% to 70% and will considerably improve cold start capability.

If, at very low temperatures, the tank is filled with only E85 and there is no way to use an engine block heater, you may experience difficulties starting the engine.

Starting the engine

If the engine fails to start, proceed as follows:

1. Fully depress the accelerator pedal.
2. Turn the ignition key to position III.

CAUTION



Release the ignition key as soon as the engine has started.

3. Gradually release the accelerator pedal after 5 seconds of engine cranking or as the engine speed rises.

If the engine fails to start, repeat steps 1, 2 and 3, or connect an engine block heater for two hours before attempting another start.

During starting, the fuel injectors are turned off as long as the accelerator pedal is depressed. This can be used to drain excessive fuel from the intake manifold after several unsuccessful starting attempts.

If the battery has been disconnected or after the fuel type has been changed, the idle speed may be irregular. This will improve after 10 to 30 seconds.

STARTING A DIESEL ENGINE

Cold or hot engine

All vehicles

Note: *When the temperature is below -15°C (5°F), you may need to crank the engine for up to 25 seconds. If you consistently operate the vehicle in such temperatures, we recommend that you have an engine block heater fitted.*

Note: *Continue cranking the engine until it starts.*

Note: *You can only operate the starter for a maximum of 30 seconds at a time.*



Switch the ignition on and wait until the glow plug indicator goes off.

Vehicles with manual transmission

Note: *Do not touch the accelerator pedal.*

1. Fully depress the clutch pedal.
2. Start the engine.

Vehicles with automatic transmission

1. Select park or neutral.
2. Fully depress the brake pedal.
3. Start the engine.

DIESEL PARTICULATE FILTER (DPF)

The DPF forms part of the emissions reduction systems fitted to your vehicle. It filters harmful diesel particulates (soot) from the exhaust gas.

Regeneration

WARNING



Do not park or idle your vehicle over dry leaves, dry grass or other combustible materials. The DPF regeneration process creates very high exhaust gas temperatures and the exhaust will radiate a considerable amount of heat during and after DPF regeneration, and after you have switched the engine off. This is a potential fire hazard.

CAUTION



Avoid running out of fuel.

Starting the engine

Note: After you have switched your engine off the fans may continue to run for a short period of time.

Unlike a normal filter which requires periodic replacement, the DPF has been designed to regenerate, or clean itself to maintain operating efficiency. The regeneration process takes place automatically. However, some driving conditions mean that you may need to support the regeneration process.

If you drive only short distances or your journeys contain frequent stopping and starting, where there is increased acceleration and deceleration, occasional trips with the following conditions could assist the regeneration process:

- Drive your vehicle at a constant speed, preferably on a main road or motorway, for up to 20 minutes.
- Avoid prolonged idling and always observe speed limits and road conditions.
- Do not switch off the ignition.
- Use a lower gear than normal to maintain a higher engine speed during this journey, where appropriate.

SWITCHING OFF THE ENGINE

Vehicles with a turbocharger

CAUTION

! Do not switch the engine off when it is running at high speed. If you do, the turbocharger will continue running after the engine oil pressure has dropped to zero. This will lead to premature turbocharger bearing wear.

Release the accelerator pedal. Wait until the engine has reached idle speed and then switch it off.

ENGINE HEATER

CAUTION

! Make sure you disconnect the power cable from the engine heater connector before driving away.

Note: The engine heater connector is located in the radiator grille at the front of your vehicle.

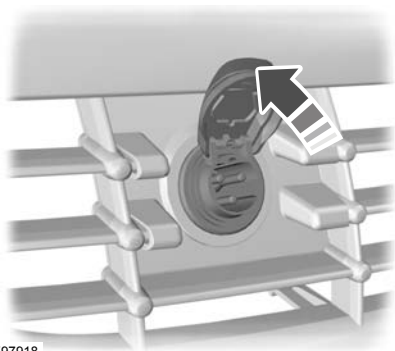

E97918

Connect the engine heater for 2 to 3 hours before starting the engine.

Fuel and refuelling

FUEL QUALITY - PETROL

CAUTION

 Do not use leaded petrol or petrol with additives containing other metallic compounds (e.g. manganese-based). They could damage the emission system.

Note: *We recommend that you use only high quality fuel without additives or other engine treatments.*

Use **minimum 95 octane unleaded** petrol that meets the specification defined by **EN 228**, or equivalent.

FUEL QUALITY - E85

WARNINGS

 Do not modify the fuel system configuration or the components in the system.

 Do not replace the fuel system or the components with parts not specially designed to be used with E85.

CAUTIONS

 Do not use leaded petrol or petrol with additives containing other metallic compounds (e.g. manganese-based). They could damage the emission system.

 Do not use methanol instead of E85.

Note: *We recommend that you use only high quality fuel without additives or other engine treatments.*

Note: *When using E85, you may experience a higher fuel consumption.*

Note: *Your vehicle will operate well on commercial quality 95 octane unleaded petrol, but only high quality E85 offers the same protection and performance.*

Use **minimum 95 octane unleaded** petrol that meets the specification defined by **EN 228**, or equivalent. You can also use a mixture of unleaded petrol and E85.

Long-term storage

Due to small amounts of corrosive impurities that may be found in the E85, it is recommended that you fill the tank with only 95 octane unleaded petrol prior to long-term storage of your vehicle.

FUEL QUALITY - DIESEL

WARNING

 Do not mix diesel with oil, petrol or other liquids. This could cause a chemical reaction.

CAUTIONS

 Do not add kerosene, paraffin or petrol to diesel. This could cause damage to the fuel system.

 Use diesel that meets the specification defined by **EN 590**, or the relevant national specification.

Note: *We recommend that you use only high quality fuel.*

Note: *The use of additives or other engine treatments not approved by Ford is not recommended.*

Note: *We do not recommend the prolonged use of additives intended to prevent fuel waxing.*

Fuel and refuelling

Long-term storage

Most diesel fuels contain bio-diesel, it is recommended to fill the tank with purely mineral diesel (where available) or add an anti-oxidant prior to long-term storage of your vehicle exceeding two months. Your dealer can help you with a suitable anti-oxidant.





CATALYTIC CONVERTER

WARNING

 Do not park or idle your vehicle over dry leaves, dry grass or other combustible materials. The exhaust will radiate a considerable amount of heat during use, and after you have switched the engine off. This is a potential fire hazard.

Driving with a catalytic converter

CAUTIONS

-  Avoid running out of fuel.
-  Do not crank the engine for long periods.
-  Do not run the engine when a spark plug lead is disconnected.
-  Do not push-start or tow-start your vehicle. Use booster cables. See **Using booster cables** (page 217).
-  Do not switch the ignition off when driving.

FUEL FILLER FLAP

WARNINGS

 Take care when refuelling to avoid spilling any residual fuel from the fuel nozzle.

WARNINGS

 Do not use any kind of flames or heat near the fuel system. The fuel system is under pressure. There is a risk of injury if the fuel system is leaking.

CAUTION

 If you use a high pressure spray to wash your vehicle, only spray the fuel filler flap briefly from a distance not less than 20 centimetres (8 inches).

Note: *Central locking also locks and unlocks the fuel filler flap. See **Locking and unlocking** (page 35).*

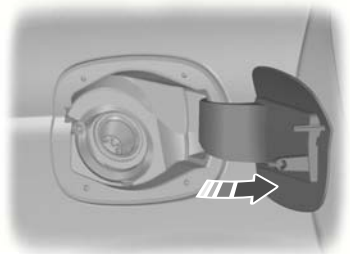

E86613

Press the flap to open it. Open the flap fully until it engages.

When you insert the fuel nozzle, a spring loaded inhibitor will open if the correct size nozzle is detected. This will prevent filling up with the wrong fuel.

WARNING

 Stop refuelling after the fuel nozzle stops the second time. Additional fuel will fill the expansion space in the fuel tank which could lead to fuel overflowing. Fuel spillage could be hazardous to other road users.

Fuel and refuelling

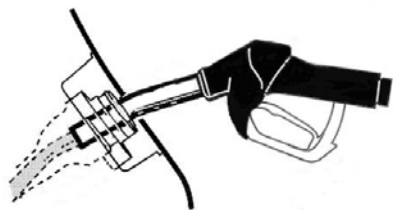

E119080

Insert the fuel nozzle up to and including the first notch on the nozzle. Keep it resting on the cover of the fuel pipe opening.

WARNING



We recommend that you wait at least 10 seconds before removing the fuel nozzle to allow any residual fuel to drain into the fuel tank.

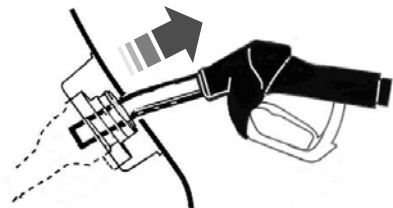

E119081

Slightly raise the fuel nozzle to remove it.

Vehicles with diesel engine

A funnel is located in the spare wheel well. Use this when refilling with a fuel can.

TECHNICAL SPECIFICATIONS

REFUELLING

CAUTION

! Do not attempt to start the engine if you have filled the fuel tank with the incorrect fuel. This could damage the engine. Have the system checked by a properly trained technician immediately.

REFUELLING - E85

CAUTION

! Do not attempt to start the engine if you have filled the fuel tank with the incorrect fuel. This could damage the engine. Have the system checked by a properly trained technician immediately.

After refuelling, allow 5 minutes of normal engine operation above 48 km/h (30 mph) to reduce the risk of an increased engine restart time.

FUEL CONSUMPTION

The CO₂ and fuel consumption figures are derived from laboratory tests according to EEC Directive 80/1268/EEC and subsequent amendments and are carried out by all vehicle manufacturers.

They are intended as a comparison between makes and models of vehicles. They are not intended to represent the real world fuel consumption you may get from your vehicle. Real world fuel consumption is governed by many factors including; driving style, high speed driving, stop/start driving, air conditioning usage, the accessories fitted and towing etc.

Your Ford dealer can give you advice on improving your fuel consumption.

Fuel and refuelling

4-door and 5-door

Fuel consumption figures

Variant	Urban	Extra-urban	Combined	CO2 emissions
	l/100 km (mpg)	l/100 km (mpg)	l/100 km (mpg)	g/km
1.6L Duratec-Ti-VCT	10 (28.2)	5.6 (50.4)	7.2 (39.2)	170
2.0L Duratec-HE Stage IV (107kW/145PS)	11.2 (25.2)	6 (47.1)	7.9 (35.8)	189
2.0L Duratec-HE Stage V (107kW/145PS)	11.2 (25.2)	6 (47.1)	7.9 (35.8)	184
2.0L EcoBoost SCTi	10.7 (26.4)	6 (47.1)	7.7 (36.7)	179
2.3L Duratec-HE (118kW/161PS)	13.8 (20.5)	6.7 (42.2)	9.3 (30.4)	223
2.5L Duratec-ST (220PS)	13.6 (20.8)	6.8 (41.5)	9.3 (30.4)	222
1.8L Duratorq-TDCi (100PS)	7.3 (38.7)	4.6 (61.4)	5.6 (50.4)	149
1.8L Duratorq-TDCi (92kW/125PS) ECONETIC	6.8 (41.5)	4.4 (64.2)	5.3 (53.3)	139
1.8L Duratorq-TDCi (92kW/125PS)	7.5 (37.7)	4.8 (58.9)	5.8 (48.7)	154
2.0L Duratorq-TDCi Stage IV, 6-speed manual transmission	7.6 (37.2)	4.9 (57.6)	5.9 (47.9)	156
2.0L Duratorq-TDCi Stage V, 6-speed manual transmission	6.4 (44.1)	4.6 (61.4)	5.3 (53.3)	139
2.0L Duratorq-TDCi (115PS), 6-speed manual transmission ECONETIC	6.6 (42.8)	4.4 (64.2)	5.2 (54.3)	139
2.0L Duratorq-TDCi Stage IV (100kW/136PS), 6-speed automatic transmission	9.7 (29.1)	5.5 (51.4)	7.1 (39.8)	187
2.0L Duratorq-TDCi Stage V, 6-speed automatic transmission	7.2 (39.2)	4.7 (60.1)	5.6 (50.4)	149

Fuel and refuelling

Variant	Urban	Extra-urban	Combined	CO2 emissions
	l/100 km (mpg)	l/100 km (mpg)	l/100 km (mpg)	g/km
2.2L Duratorq-TDCi (175PS), 6-speed manual transmission	8.4(33.6)	4.9 (57.6)	6.2 (45.6)	165

Estate

Fuel consumption figures

Variant	Urban	Extra-urban	Combined	CO2 emissions
	l/100 km (mpg)	l/100 km (mpg)	l/100 km (mpg)	g/km
1.6L Duratec-Ti-VCT	10 (28.2)	5.6 (50.4)	7.2 (39.2)	170
2.0L Duratec-HE Stage IV (107kW/145PS)	11.2 (25.2)	6 (47.1)	7.9 (35.8)	189
2.0L Duratec-HE Stage V (107kW/145PS)	11.2 (25.2)	6 (47.1)	7.9 (35.8)	184
2.0L EcoBoost SCTi	10.7 (26.4)	6 (47.1)	7.7 (36.7)	179
2.3L Duratec-HE (118 kW/161PS), 6-speed automatic transmission	13.8 (20.5)	6.7 (42.2)	9.3 (30.4)	223
2.5L Duratec-ST (220PS)	13.6 (20.8)	6.8 (41.5)	9.3 (30.4)	222
1.8L Duratorq-TDCi	7.4 (38.2)	4.7 (60.1)	5.7 (49.6)	151
1.8L Duratorq-TDCi (92 kW/125PS) ECONETIC	6.9 (40.9)	4.5 (57.6)	5.4 (47.9)	142
1.8L Duratorq-TDCi (92 kW/125PS)	7.6 (37.2)	4.9 (62.8)	5.9 (52.3)	156
2.0L Duratorq-TDCi - Stage IV	7.6 (37.2)	4.9 (57.6)	5.9 (47.9)	156
2.0L Duratorq-TDCi Stage V, 6-speed manual transmission	6.4 (44.1)	4.6 (61.4)	5.3 (53.3)	139

Fuel and refuelling

Variant	Urban	Extra-urban	Combined	CO2 emissions
	l/100 km (mpg)	l/100 km (mpg)	l/100 km (mpg)	g/km
2.0L Duratorq-TDCi (85 kW/115PS), 6-speed manual transmission ECONETIC	6.6 (42.8)	4.4 (64.2)	5.2 (54.3)	139
2.0L Duratorq-TDCi Stage IV (100 kW/136PS), 6-speed automatic transmission	9.7 (29.1)	5.5 (51.4)	7.1 (39.8)	187
2.0L Duratorq-TDCi Stage V, 6-speed automatic transmission	7.2 (39.2)	4.7 (60.1)	5.6 (50.4)	149
2.2L Duratorq-TDCi, 6-speed manual transmission	8.4(33.6)	4.9 (57.6)	6.2 (45.6)	165

Transmission

MANUAL TRANSMISSION

CAUTION

 Do not engage reverse gear when the vehicle is moving. This can cause damage to the transmission.

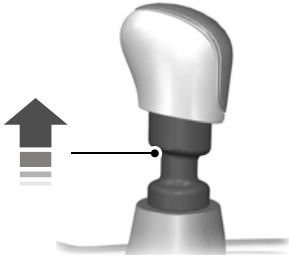

E99067

On some vehicles it is necessary to raise the collar whilst selecting reverse gear.

AUTOMATIC TRANSMISSION

Selector lever positions



E80836

- P Park
- R Reverse

- N Neutral
- D Drive
- S Sport mode and manual shifting

WARNING

 Apply the brakes before moving the selector lever and keep them applied until you are ready to move off.

Note: A cold engine has a higher idle speed. This will increase the tendency for your vehicle to **creep** when you have selected a drive gear.

Press the button on the selector lever to select reverse and park.

The selector lever position will be shown in the information display.

Park

WARNINGS

 Select park only when your vehicle is stationary.

 **Apply the parking brake and select park before leaving your vehicle.** Make sure that the selector lever is latched in position.

Note: An audible warning will sound if you open the driver's door and you have not selected park.

In this position, power is not transmitted to the drive wheels and the transmission is locked. You can start the engine with the selector lever in this position.

Reverse

WARNING

 Select reverse only when your vehicle is stationary and the engine is at idle speed.

Transmission

Neutral

In this position, power is not transmitted to the drive wheels but the transmission is not locked. You can start the engine with the selector lever in this position.

Drive

Select drive to shift automatically through the forward gears.

Sport mode and manual shifting

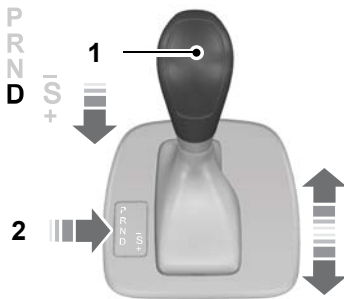

E80837

Note: A shift will occur only when the vehicle speed and the engine speed are appropriate.

Note: When you select position **S**, a gear change may occur depending on the accelerator pedal position in relation to actual vehicle speed.

Activate sport mode by moving the selector lever to position **S**. Sport mode will remain active until you shift manually up or down the gears.

Select manual shifting to shift manually through the forward gears. Push the selector lever forwards to shift down and pull it backwards to shift up.

Drive modes

The transmission will select the appropriate gear for optimum performance based on ambient temperature, road gradient, vehicle load and driver input.

Hints on driving with an automatic transmission

Moving off

1. Release the parking brake.
2. Release the brake pedal and press the accelerator pedal.

Stopping

1. Release the accelerator pedal and press the brake pedal.
2. Apply the parking brake.

Kickdown

Press the accelerator pedal fully with the selector lever in the drive position to select the next lowest gear for optimum performance. Release the accelerator pedal when you no longer require kickdown.

Emergency park position release lever

Use the lever to move the selector lever from the park position in the event of an electrical malfunction or if your vehicle has a flat battery.

Transmission



E87934

1. Remove the centre console side panel.

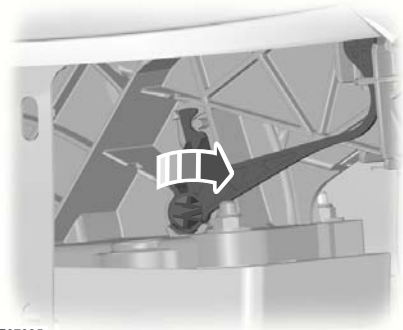

E87935

Note: *The lever is yellow.*

1. Insert a flat-bladed screwdriver into the slot and turn the screwdriver clockwise 90 degrees.

Brakes

PRINCIPLE OF OPERATION

Disc brakes

Wet brake discs result in reduced braking efficiency. Dab the brake pedal when driving from a car wash to remove the film of water.

ABS

WARNING



The ABS does not relieve you of your responsibility to drive with due care and attention.

The ABS helps you to maintain full steering and directional stability when you brake heavily in an emergency, by preventing the road wheels from locking.

HINTS ON DRIVING WITH ABS

When the ABS is operating, the brake pedal will pulse. This is normal. Maintain pressure on the brake pedal.

The ABS will not eliminate the dangers inherent when:

- you drive too close to the vehicle in front of you.
- the vehicle is aquaplaning.
- you take corners too fast.
- the road surface is poor.

PARKING BRAKE

Applying the parking brake

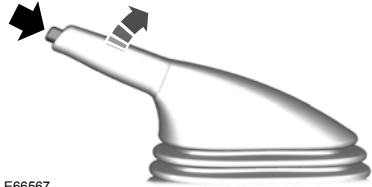

E66567

WARNING



Make sure that the parking brake is applied before you release the lever.

Note: Do not press the release button when you apply the parking brake.

1. Press the brake pedal firmly.
2. Pull the parking brake lever upwards to its fullest extent.

Parking on a hill

If you have to park facing uphill, select first gear and turn the front wheels away from the kerb. If you have to park facing downhill, select reverse gear and turn the front wheels towards the kerb.

Releasing the parking brake

1. Press the brake pedal firmly.
2. Pull the parking brake lever upwards slightly, press the release button and push the lever downwards.

Stability control

PRINCIPLE OF OPERATION

Electronic stability programme (ESP)

WARNING



ESP does not relieve you of your responsibility to drive with due care and attention.

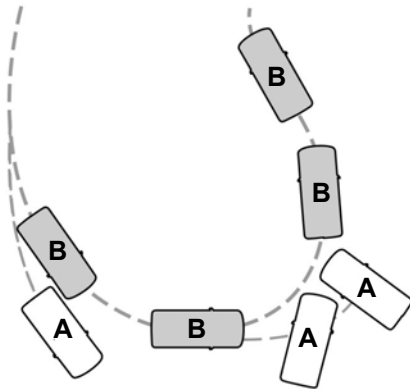

E72903

- A without ESP
- B with ESP

The ESP supports stability when the vehicle starts to slide away from your intended path. This is performed by braking individual wheels and reducing engine torque as needed.

The system also provides an enhanced traction control function by reducing engine torque if the wheels spin when you accelerate. This improves your ability to pull away on slippery roads or loose surfaces, and improves comfort by limiting wheel spin in hairpin bends.

Stability control (ESP) warning lamp

The ESP warning lamp will flash when the system is operating. See **Warning lamps and indicators** (page 75).

Emergency brake assist

WARNING



Emergency brake assist does not relieve you of your responsibility to drive with due care and attention.

Emergency brake assist will detect when you brake heavily by measuring the rate at which you press the brake pedal. It will provide maximum braking efficiency as long as you press the pedal. Emergency brake assist can reduce stopping distances in critical situations.

USING STABILITY CONTROL



Press and hold the switch for one second. The switch will illuminate. A message will be shown in the display. See **Information messages** (page 91).

Information messages (page 91).

Press the switch again to turn the system on. The system will be switched on automatically every time you switch the ignition on.

You can switch the system on and off via the information display menu. See **Information displays** (page 78).

Hill start assist

PRINCIPLE OF OPERATION

The system makes it easier to pull away when the vehicle is on a slope without the need to use the parking brake.

When the system is active, the vehicle will remain stationary on the slope for two to three seconds after you release the brake pedal. During this time, you have time to move your foot from the brake to the accelerator pedal and pull away. The brakes are released automatically once the engine has developed sufficient drive to prevent the vehicle from rolling down the slope. This is an advantage when pulling away on a slope, for example from a car park ramp, traffic lights or when reversing uphill into a parking space.

WARNING



The system does not replace the parking brake. When you leave the vehicle, always apply the parking brake and select first or reverse gear.



E70499

Hill Launch

- Off
- Auto
- Manual

USING HILL START ASSIST

The system can operate in either automatic or manual mode. If you select automatic mode, the system is activated automatically when the vehicle is on a slope and you press the brake pedal. If you select manual mode, you must activate the system using the brake pedal.

To set the system mode:

E74629

1. Press the right arrow button on the steering wheel to enter the main menu.
2. Highlight **Setup** with the up and down buttons and press the right arrow button.
3. Highlight **Hill Launch** and press the right arrow button.
4. Highlight the desired setting and press the **OK** button to confirm the setting. If **Off** is selected, the system is switched off and cannot be activated either automatically or manually.
5. Press the left arrow button to exit the menu. To return to the trip computer display directly, hold the left arrow button pressed.

Hill start assist

Note: When the system is in manual activation mode, only use the system when pulling away uphill on gradients greater than 3%. If the vehicle is on the flat or on a downhill slope, an active system will make it difficult to pull away smoothly.

Activating the system

WARNINGS



You must remain in the vehicle once you have activated the system. Any attempt to leave the vehicle will deactivate the system automatically.



The system is active only if the message **Hill Launch Assist active** is displayed in the information display. During all times you are responsible for controlling the vehicle, supervising the system and intervening, if required.

You can activate the system only if the following conditions have been met:

- The engine is running.
- The system is switched on (automatic or manual mode).
- The parking brake is fully disengaged.
- On vehicles with manual transmission, the clutch pedal is pressed.
- On vehicles with automatic transmission, the driver door is closed.
- No failure mode is present.

To activate the system in automatic mode:

1. Press the brake pedal to bring the vehicle to a complete standstill. Keep the brake pedal depressed.

2. If the sensors detect that the vehicle is on a slope and the right driving direction is selected (first gear if the vehicle is pointing uphill, reverse gear if the vehicle is pointing downhill), the system will be activated automatically. **Hill Launch Assist active** will appear in the display.
3. When you remove your foot from the brake pedal, the vehicle will remain on the slope without rolling away for approximately two to three seconds.
4. Pull away using the accelerator and clutch pedal. The brakes will be released automatically.

To activate the system in manual mode:

1. Press the brake pedal to bring the vehicle to a complete standstill. Keep the brake pedal depressed.
2. Quickly jab the brake pedal further until **Hill Launch Assist active** appears in the display. The system is now active.
3. When you remove your foot from the brake pedal, the vehicle will remain on the slope without rolling away for approximately two to three seconds.
4. Pull away using the accelerator and clutch pedal. The brakes will be released automatically.

WARNING



When the system is active and the system detects a failure, the system is deactivated and the message **Please use park brake!** followed by **Hill Launch A .not available** will be displayed. The vehicle is still safe to be driven and can be repaired during the next service. The message **Hill Launch A .not available** will also be displayed with manual activation during a failure or if one of the activation criteria is not met. If you have switched the system off, no messages will be displayed.

Hill start assist

Deactivating the system

To deactivate the system, perform **one** of the following:

- Apply the parking brake.
- Wait for two to three seconds until the system deactivates automatically.
- If a forward gear was selected when the system became active, select reverse gear.
- If reverse gear was selected when the system became active, select a forward gear.

Hill Launch Assist off will appear in the instrument cluster display.

Active suspension

PRINCIPLE OF OPERATION

The active suspension provides improved handling, comfort and stability by continuously adjusting the damper properties to the current road and driving conditions. This system in conjunction with the ABS system offers the benefit of potentially shorter stopping distances on rough road surfaces.

Depending on your preferences and driving style, you can choose between three different settings:

Comfort

This provides a softer driving feel.

Normal

Normal setting.

Sport

This provides a harder, sportier ride.

USING ACTIVE SUSPENSION

Selecting a setting

Note: *After you select a setting, you may not immediately notice a difference in the vehicle's handling. The effect of the continuously controlled damping depends on the road surface and driving conditions.*

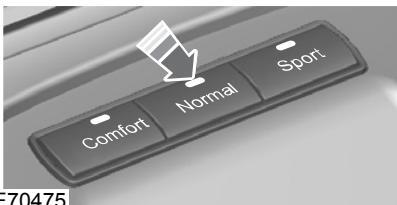

E70475

You can change the setting while driving.

System malfunction

The active suspension system will switch off automatically if it malfunctions. The suspension will be set to a fail-safe condition that will enable you to continue driving but you will not be able to change the suspension setting. Have this checked as soon as possible.

Parking aid

PRINCIPLE OF OPERATION

WARNING



The parking aid does not relieve you of your responsibility to drive with due care and attention.

CAUTIONS



Vehicles fitted with a trailer tow module not approved by us may not correctly detect obstacles.



The sensors may not detect objects in heavy rain or other conditions that cause disruptive reflections.



The sensors may not detect objects with surfaces that absorb ultrasonic waves.



The parking aid does not detect obstacles moving away from the vehicle. They will only be detected shortly after they start to move towards the vehicle again.



Take particular care when reversing with a tow ball arm or rear fitted accessories e.g. a bicycle carrier, as the rear parking aid will only indicate the distance from the bumper to the obstacle.



If you use a high pressure spray to wash your vehicle, only spray the sensors briefly from a distance not less than 20 centimetres (8 inches).

Note: On vehicles fitted with a tow ball arm, the parking aid is deactivated automatically when any trailer lamps (or lighting boards) are connected to the 13-pin socket via a trailer tow module we have approved.

Note: Keep the sensors free from dirt, ice and snow. Do not clean with sharp objects.

Note: The parking aid may emit false tones if it detects a signal using the same frequency as the sensors or if the vehicle is fully laden.

Note: The outer sensors may detect the side walls of a garage. If the distance between the outer sensor and the side wall remains constant for three seconds, the tone will switch off. As you continue, the inner sensors will detect rearward objects.

USING THE PARKING AID

Switching the parking aid on and off

Note: The parking aid switches off automatically when you start the engine or when you exceed 16 km/h (10 mph).

Note: The front and rear sensors are always activated or deactivated together.

The parking aid is per default off. To switch the parking aid on, press the switch in the instrument panel or select reverse gear.

The light in the switch illuminates when the parking aid is activated.

To turn it off, press the switch again.

Manoeuvring with the parking aid

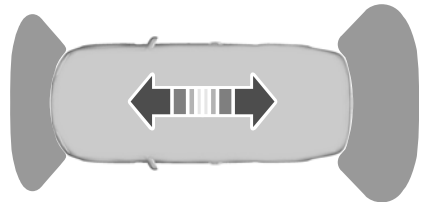

E72902

Parking aid

Note: *If a high pitch warning tone sounds for three seconds and the light in the switch is flashing, it indicates a malfunction. The system will be disabled. Have the system checked by properly trained technicians.*

You will hear an intermittent tone at a distance of up to approximately 150 centimetres (59 inches) between the obstacle and rear bumper, 80 centimetres (31 inches) between the obstacle and front bumper and 50 centimetres (20 inches) to the side. Decreasing the distance accelerates the intermittent tone. A continuous tone will start at a distance of less than 30 centimetres (12 inches).

You will hear an alternating tone from the front and rear if obstacles are closer than 30 centimetres (12 inches) to the front and rear bumpers.

Cruise control

PRINCIPLE OF OPERATION

Cruise control allows you to control your speed using the switches on the steering wheel. You can use cruise control when you exceed 30 km/h (20 mph).

USING CRUISE CONTROL

WARNING



Do not use cruise control in heavy traffic, on twisty roads or when the road surface is slippery.

Switching cruise control on

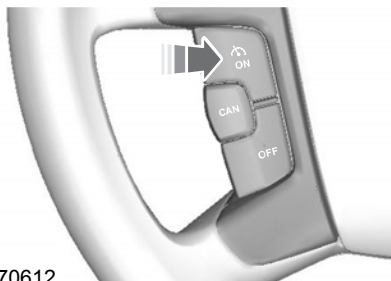

E70612

Setting a speed

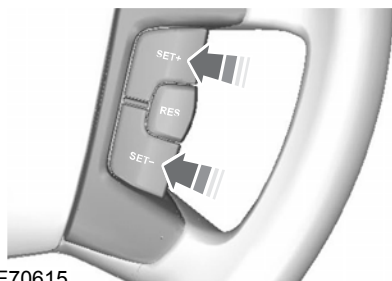

E70615

Press the **SET+** switch or the **SET-** switch to store and maintain your current speed. The cruise control indicator illuminates.

Changing the set speed

WARNING



When you are going downhill, your speed may increase above the set speed. The system will not apply the brakes. Change down a gear and press the **RES** switch to assist the system in maintaining the set speed.

Note: If you accelerate by pressing the accelerator pedal, the set speed will not change. When you release the accelerator pedal, you will return to the speed that you previously set.

Press the **SET+** switch or the **SET-** switch to accelerate or decelerate.

Cancelling the set speed

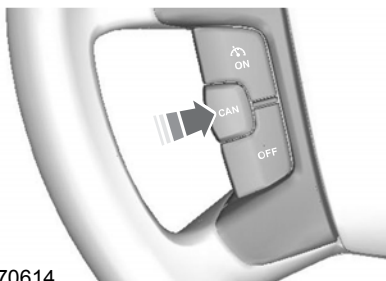

E70614

Press the brake pedal or the **CAN** switch. The system will no longer control your speed. The cruise control indicator will go off but the system will retain the speed that you previously set.

Cruise control

Resuming the set speed

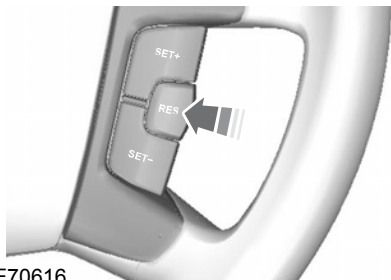

E70616

Press the **RES** switch. The cruise control indicator illuminates and the system will attempt to resume the speed that you previously set.

Switching cruise control off

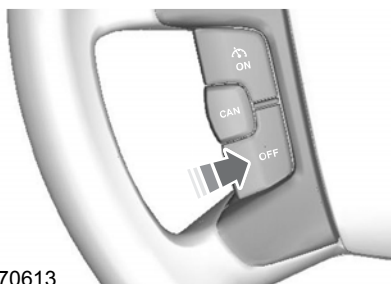

E70613

Press the **OFF** switch. The system will not retain the speed that you previously set. The cruise control indicator will go off.

Adaptive cruise control (ACC)

PRINCIPLE OF OPERATION

The adaptive cruise control system is designed to help you maintain a gap from the vehicle ahead or a set road speed if there is no slower vehicle ahead. The system is intended to provide enhanced operation of the vehicle when following other vehicles which are in the same lane and travelling in the same direction.

WARNINGS



Adaptive cruise control is not a collision warning or avoidance system. The separate forward alert function provides a collision warning and mitigation feature. See **Forward alert function** (page 155). You must intervene if the system does not detect a vehicle in front.



Adaptive cruise control cannot cover all traffic, weather and road conditions.



When driving you are responsible for maintaining the correct distance and speed, even when adaptive cruise control is used. You must always pay attention to the traffic conditions and intervene when adaptive cruise control is not maintaining a suitable speed or suitable distance.



The adaptive cruise control does not brake for slow or stationary vehicles.



When ACC is activated, you may hear some unusual sounds during automatic braking. This is normal and caused by the automatic braking system.

The adaptive cruise control system is based on the use of a radar sensor which projects a beam directly forward of the vehicle. This beam will detect any vehicle ahead within the system's range.

The radar sensor is mounted behind the front grille, immediately to the right of the Ford badge (when viewed from the front of the vehicle).

When using ACC, follow the strict guidelines below:

- Only use adaptive cruise control when conditions are favourable, for example on motorways and main roads with steady free flowing traffic.
- Do not use in poor visibility, specifically fog, heavy rain, spray or snow.
- Do not use on icy or slippery roads.
- It is your responsibility to stay alert, drive safely and be in control of the vehicle at all times.
- Keep the front of the vehicle free from dirt, metal badges or objects, including vehicle front protectors and additional lights which may prevent the sensor from operating.
- Do not use ACC when entering or leaving a motorway.

The radar sensor has a limited field of vision. In some situations it may detect a vehicle other than the one expected or not detect any vehicle at all.

Adaptive cruise control (ACC)

Detection beam issues

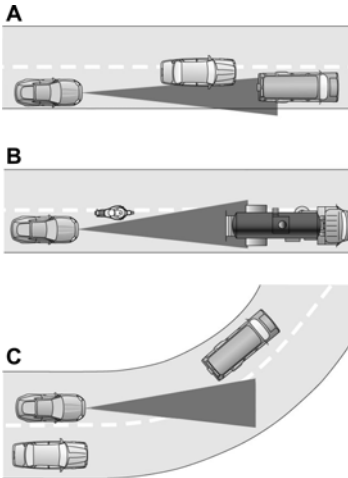

E71621

Detection issues can occur:

- When driving on a different line to the vehicle in front (**A**).
- With vehicles that edge into your lane that can only be detected once they have moved fully into your lane (**B**). Motorcycles may be detected late, or not at all.
- There may be issues with the detection of vehicles in front when going into and coming out of a bend (**C**). The detection beam will not follow sharp curves in the road.

WARNING



In these cases ACC may brake late or unexpectedly. The driver should stay alert and intervene if necessary.

Automatic braking with ACC

Adaptive cruise control will automatically brake for you, if required to maintain the set gap between your vehicle and the one detected in front. This braking capacity is limited to approximately 30% of the total manual braking capacity to ensure smooth and comfortable cruising. If the car needs to brake more heavily than this, and you do not intervene by braking manually, an alarm will sound and a warning symbol will be displayed in the cluster.

WARNING



You must take immediate action once alerted, as the ACC braking will not be sufficient to keep a safe distance to the vehicle in front.

USING ACC

The system is operated by adjustment controls mounted on the steering wheel. The system is deactivated when the brakes are used, the gear selector is moved to a neutral position or if the accelerator pedal is depressed for a longer period. The system will change to standby mode, allowing you full manual control of the vehicle.

Note: *The system may be deactivated if the clutch is depressed.*

Note: *If the accelerator is depressed for a short period, for example when overtaking, the system is temporarily deactivated and then reactivated when the accelerator pedal is released. **ACC override** is displayed in the information display.*

Adaptive cruise control (ACC)

Vehicles without speed limiter

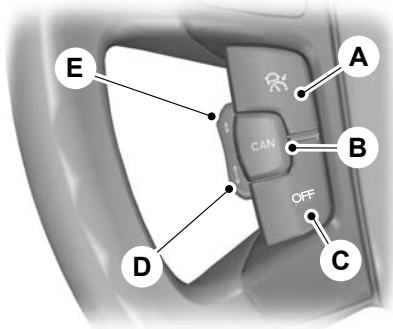

E124908

- A ACC on
- B ACC cancel
- C ACC off
- D ACC gap increase
- E ACC gap decrease

Vehicles with speed limiter

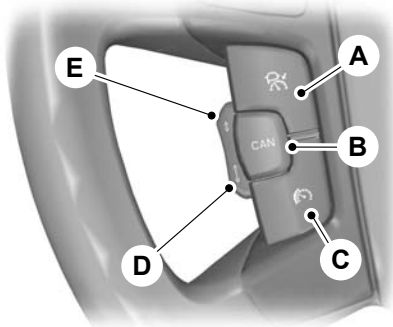

E124909

- A ACC on/off
- B ACC cancel
- C Speed limiter on/off

- D ACC gap increase
- E ACC gap decrease

Switching ACC on

Press switch **A**. The system is set to standby mode and **Standby** is displayed in the information display.

Setting a speed

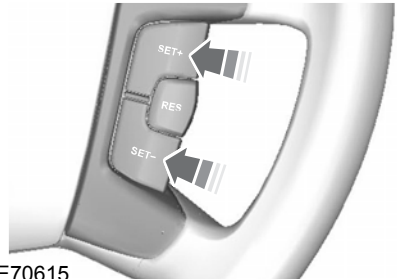

E70615

Note: The system must be in **Standby** mode.

Press the **SET+** switch or the **SET-** switch to select your desired cruise speed. The speed is displayed in the information display and stored as the set speed. The **ACC** indicator illuminates.

Note: Vehicle speed may be increased and decreased at intervals of 5 km/h or 5 mph. Smaller increases of 1 km/h or 1 mph may be set by pressing the **RES** switch.

Changing the set speed

Press the **SET+** switch or the **SET-** switch to accelerate or decelerate.

Note: If the system does not react to these changes the reason may be that the gap interval to the vehicle in front prevents an increase in speed.

Adaptive cruise control (ACC)

Setting the vehicle gap

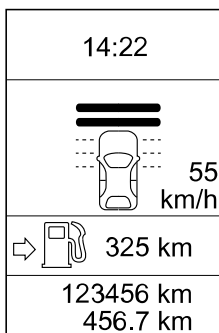

E82311

The distance between you and the vehicle detected in front is maintained by a variable setting. There are five steps which are represented by horizontal bars displayed in the information display. One bar denotes the smallest gap and five bars indicate the largest gap. These bars are shown empty when in standby mode and filled when in active mode.

If no vehicle is detected in front, then only your vehicle is displayed in the information display below the bars. The system will maintain the set speed when conditions permit. The set gap is maintained and displayed.

If a vehicle is detected by the sensor, the display will show another vehicle above the horizontal bars:

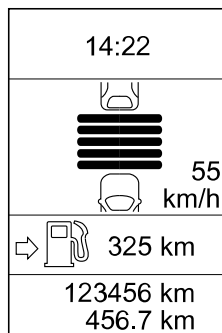

E82312

This is a follow mode, and the system will accelerate or decelerate as necessary to maintain the set gap.

Press switch **E** to decrease the gap or switch **D** to increase the gap. The gap selected will be represented by the number of bars in the display. The recommended gap setting is three to five bars.

Note: *The gap setting is time dependant and therefore the distance will automatically adjust with your speed. For example on a gap setting of four bars, the time gap is 1.8 seconds. This will mean that at a speed of 100 km/h (62 mph), the distance to the vehicle in front will be maintained at 50 metres (164 feet)*

CAUTION

⚠ Use the appropriate gap setting in accordance with local traffic regulations.

Cancelling ACC

Press either the brake or switch **B**. The system will return to standby mode but will retain the set speed and gap in the memory. The **ACC** indicator will go off.

Adaptive cruise control (ACC)

Note: *The system may be deactivated if the clutch is depressed.*

Resuming ACC

Press the **RES** switch. The **ACC** indicator illuminates and the system will resume with the previously set speed and vehicle gap setting if conditions permit.

Switching ACC off

Vehicles without speed limiter

Press switch **C**.

Note: *Pressing switch **C** does not return the system to standby mode. The stored speed is not retained.*

Note: *To temporarily deactivate the system press switch **B**.*

Vehicles with speed limiter

Press switch **A**.

Note: *Pressing switch **A** does not return the system to standby mode. The stored speed is not retained.*

Note: *To temporarily deactivate the system press switch **B**.*

Automatic deactivation

The system is dependent on various other safety systems, for example ABS and ESP. If any of these systems are malfunctioning or reacting to an emergency, the system is automatically deactivated.

In the event of automatic deactivation a signal will sound and the message **ACC cancel** is displayed in the information display. You must then intervene and adapt your driving and speed to vehicles in front.

An automatic deactivation can be due to the:

- vehicle speed falling below 30 km/h (20 mph)
- wheels lose traction
- brake temperature is high, for example when driving on mountainous or hilly roads
- engine speed is too low
- radar sensor is covered
- parking brake or electric parking brake (EPB) is applied.

If the engine speed drops too low, a message is displayed in the information display instructing you to change down a gear (manual transmission only). If you do not follow this recommendation then the system will go into automatic deactivation mode.

Note: *The system will not operate if the electronic stability programme (ESP) has been manually switched off.*

FORWARD ALERT FUNCTION

The system assists you by warning of the risk of a collision, and reducing the severity of a collision with a vehicle in front. This works by using two methods:

- You are alerted to a potential collision so you may brake earlier than normal.
- Brake support is activated to enable full braking effectiveness.

The collision alerts will only occur if the system is switched on, however the brake support is always on and cannot be turned off. Warnings are both visual and audible. Brake support is activated automatically if necessary to reduce the collision speed. The brake support system only reduces the collision speed if you brake immediately once alerted.

Adaptive cruise control (ACC)

WARNINGS



Never wait for a collision warning. When driving you are responsible for maintaining the correct distance and speed, even when the system is used.



The system will only react to vehicles in front travelling in the same direction and will not react to slow or stationary vehicles.



Never drive in a manner to provoke the system. The system is designed to assist in emergencies only.

The system alerts you by warning chimes and a visual warning in the information display. See **Information messages** (page 91).

When forward alert is deactivated the lamp is illuminated in the display. See **Warning lamps and indicators** (page 75).

The system does not operate in all driving situations and traffic, weather and road conditions.

The radar sensor detects vehicles in front that are driving in the same direction as you. If the risk of collision still increases after the initial warning then brake support is activated. Brake support prepares the brake system for rapid braking and the brakes are applied gently, which may be noticed as a slight jerk. If the brake pedal is depressed sufficiently quickly then braking is implemented with full brake function, even if the force on the pedal is light.

CAUTION



Warnings may be triggered late, be absent or triggered unnecessarily if the traffic situation means that the radar sensor cannot accurately detect a vehicle in front. The system uses the same radar sensors as adaptive cruise control (ACC) and therefore has the same limitations. See **Principle of operation** (page 151).

Note: *The system may be used with or without the ACC system being activated.*

Switching forward alert on and off

See **General information** (page 78).

Adjusting the warning sensitivity

You may adjust the system warning sensitivity using the buttons on the steering wheel. See **General information** (page 78).

This controls how early the visual and audible warning is activated.

Speed limiter

PRINCIPLE OF OPERATION

WARNING

 When you are going downhill, your speed may increase above the set speed. The system will not apply the brakes but a warning will be given.

The system allows you to set a speed, to which the vehicle then becomes limited. The set speed will become the effective maximum speed of the vehicle, but with the option to temporarily exceed this limit if required.

USING THE SPEED LIMITER

The system is operated by adjustment controls mounted on the steering wheel.

Press button **A** to switch the system on and off. The information display will prompt for a speed to be set.

Note: *The set speed limit can be intentionally exceeded for a short period if required, for example when overtaking.*

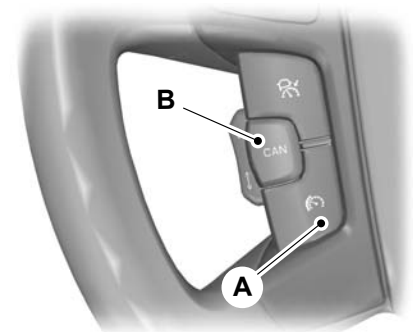

E124874

Setting the speed limit

Use the cruise control switches to alter the maximum speed setting.

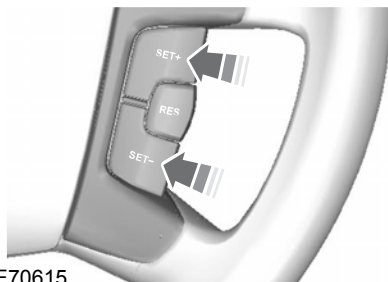

E70615

Press the **SET+** switch or the **SET-** switch to select your desired speed limit. The speed is indicated in the information display and stored as the set speed.

Press button **B** to cancel the limiter and place it in standby mode. The information display will confirm deactivation by showing the set speed crossed out.

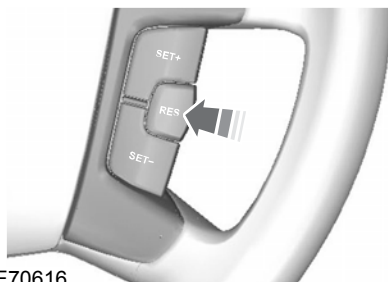

E70616

Press the **RES** button to resume the limiter. The information display will confirm the system is active by showing the set speed again.

Intentionally exceeding the speed limit

Depress the accelerator hard close to the full pedal travel and the limit will temporarily deactivate. The system will reactivate once the vehicle speed drops below the set speed.

Speed limiter

System warnings







If the set limit is accidentally exceeded the information display will show the set speed flashing together with an audible warning chime.

If the set limit is intentionally exceeded the information display will show the set speed crossed out.



Load carrying

GENERAL INFORMATION

WARNINGS

-  Use load securing straps to an approved standard, e.g. DIN.
-  Make sure that you secure all loose items properly.
-  Place luggage and other loads as low and as far forward as possible within the luggage or loadspace.
-  Do not drive with the tailgate or rear door open. Exhaust fumes may enter the vehicle.
-  Do not exceed the maximum front and rear axle loads for your vehicle. See **Vehicle identification** (page 234).
-  Heavy loads, when placed in the passenger compartment, should be on folded rear seats as shown. See **Rear seats** (page 117).

CAUTIONS

-  Do not allow items to contact the rear windows.
-  Do not use any abrasive materials to clean the interior of the rear windows.
-  Do not install stickers or labels to the interior of the rear windows.

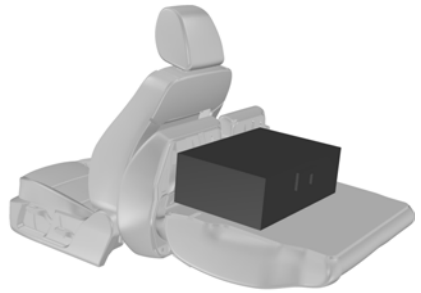

E97377

LUGGAGE ANCHORPOINTS

Estate



E86912

Load carrying

4-door and 5-door



E86913

SLIDING LOADSPACE FLOOR

WARNING



Do not slide the loadspace floor rearwards when the vehicle is standing on an incline of 15 degrees or more and facing uphill.

CAUTION



The maximum permissible weight on the sliding loadspace floor is 200 kilogrammes (441 pounds).

The maximum permissible weight on the end of the sliding loadspace floor when the floor is in the fully extended position (slid outside the luggage compartment) is 120 kilogrammes (265 pounds).



E74810

Press the unlocking handle and pull the loadspace floor rearwards. It will stop and engage at a midway position.

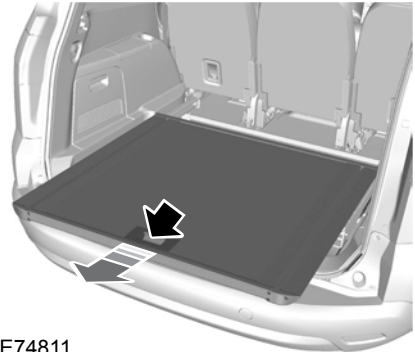

E74811

To slide it out fully, press the unlocking handle again and pull it out until it engages in the end position.

To slide it forwards, press the unlocking handle and push it forwards.

Note: You do not have to exert as much pressure on the unlocking handle if you push the loadspace floor forwards slightly when operating it.

Load carrying

Storage compartment

A storage compartment is located in the floor at the rear of the luggage compartment.

To gain access to the storage compartment, lift up the sliding loadspace floor as follows:

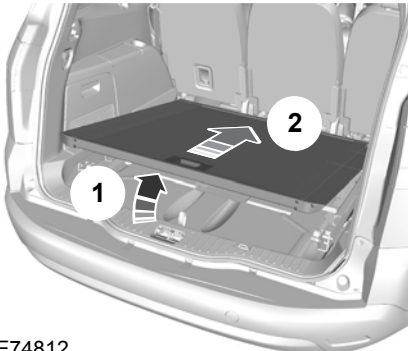

E74812

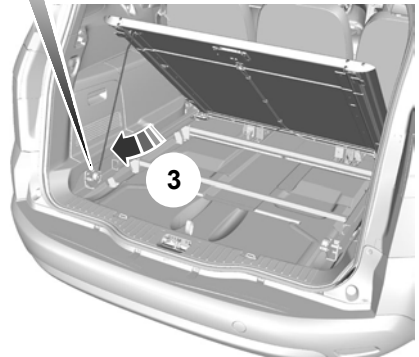
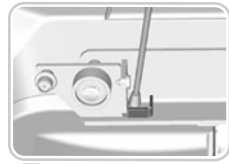

E74813

1. Press the unlocking handle and pull the loadspace floor rearwards a short way.
2. Lift up the rear of the floor (1).
3. Push the floor forwards until it engages at the front (2).
4. Release the support leg from the clip on the underside of the floor.
5. Insert the end into the square retainer in the left-hand rail (3).
6. Lift the storage compartment cover using the loop.

To return the loadspace floor to the normal position:

1. Hold the floor with one hand and release the support leg with the other hand.
2. Insert the support leg back into the clip.

Load carrying

3. Lower the floor.
4. Press the unlocking handle and pull the loadspace floor rearwards until it drops into position on the rails.

REAR UNDER FLOOR STORAGE

Vehicles with a sliding loadspace floor

Raise the loadspace floor to gain access to the storage compartment. See **Sliding loadspace floor** (page 160).

Vehicles without a sliding loadspace floor

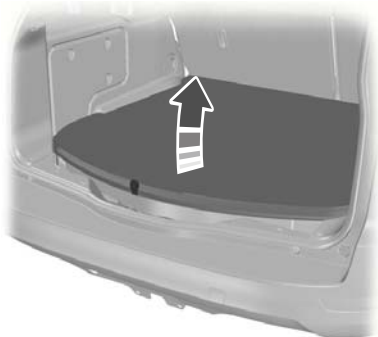

E87689

CARGO NETS

Luggage retention net

Installing the net



E87052

1. Push the ends of the upper bar towards each other and insert them into the retainers on the roof. Push the bar forwards into the narrow section of the retainers.



E87053

2. Attach the net to the luggage anchor points. See **Luggage anchor points** (page 159).

Load carrying



E87054

3. Tighten the belts.

Removing the net



E87135

1. Release the belts.
2. Remove the net from the luggage anchor points.
3. Remove the upper bars.

LUGGAGE COVERS

WARNING



Do not place objects on the luggage cover.

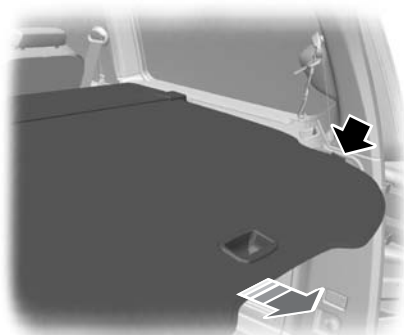

E72969

Pull out the cover and secure it in the retaining points.

Release it from the retaining points and let it roll back into the case. Clip the retaining hook onto the case.

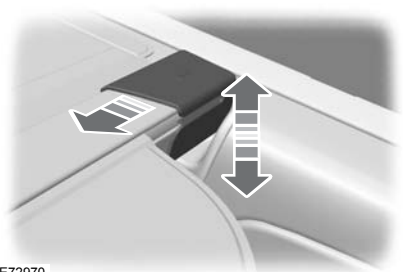

E72970

To remove or install the cover, push either end of the case inwards.

Load carrying

ROOF RACKS AND LOAD CARRIERS

Roof rack

WARNINGS



If you use a roof rack, the fuel consumption of your vehicle will be higher and you may experience different driving characteristics.



Read and follow the manufacturer's instructions when you are fitting a roof rack.

CAUTION



Do not exceed the maximum permissible roof load of 75 kilogrammes (165 pounds) (including the roof rack).

Check the security of the roof rack and tighten its fittings as follows:

- before starting
- after driving 50 kilometres (30 miles)
- at 1 000 kilometres (600 miles) intervals.

To minimise windnoise when the roof rack is not in use, cross rails should be moved rearwards and placed together. To reduce fuel consumption, cross rails should be removed when not in use.

DOG GUARD

CAUTION



Keep a distance of at least one centimetre between the dog guard and the seats in front of it.

Installing behind the front seats

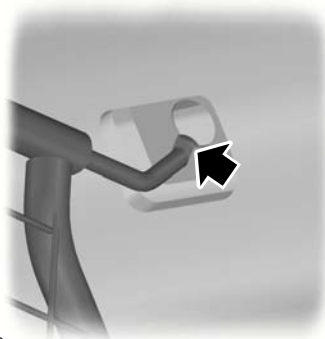

E86848

1. Push the ends of the bar on the grille towards each other and insert them into the retainers on the roof. Push the bar forwards into the narrow section of the retainers.

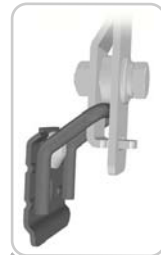

E87782

2. Attach the dog guard to the lower anchor points. Do not tighten the screws.

Load carrying



E87783

3. Attach the grille to the lower bar with the handwheels. Do not tighten the handwheels.
4. Tighten the screws at the lower anchor points.
5. Tighten the handwheels.

Installing behind the rear seats



E86848

1. Push the ends of the bar on the grille towards each other and insert them into the retainers on the roof. Push the bar forwards into the narrow section of the retainers.

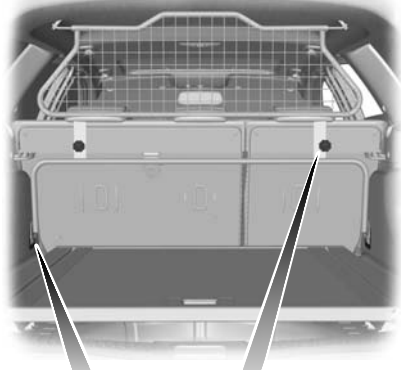

E104424

2. Remove two screws from both the luggage anchor points. See **Luggage anchor points** (page 159).
 3. Attach the lower bar to the grille with the handwheels. Do not tighten the handwheels.
 4. Attach the dog guard lower bar to the luggage anchor points, secure with the new supplied screws.
 5. Tighten the handwheels.
- Remove in the reverse order.

Load carrying

LOAD RETAINING FIXTURES

WARNING

 Do not exceed the maximum permissible load of 60 kilogrammes (132 pounds) on two load retaining fixtures and 30 kilogrammes (66 pounds) on one.

Check the security of the load retaining fixtures and tighten its fittings as follows:

- before starting
- after driving 50 kilometres (30 miles)
- at 1 000 kilometres (600 miles) intervals.

Installing the load retaining fixtures

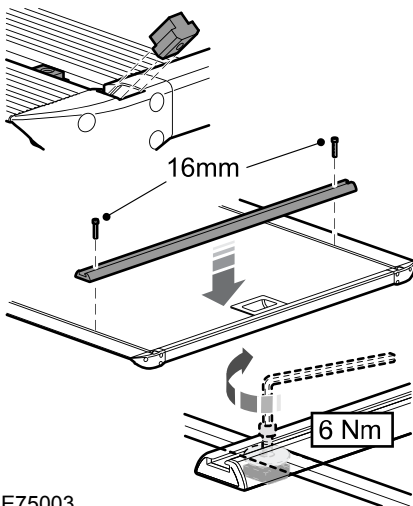

E75003

Installing the load bracket

WARNINGS

 Install the load bracket with the longest section towards the rear of the vehicle. If you install it the wrong way round, it may not hold the box in place in the event of an accident.

 Do not exceed the maximum permissible load of 20 kilogrammes (44 pounds).

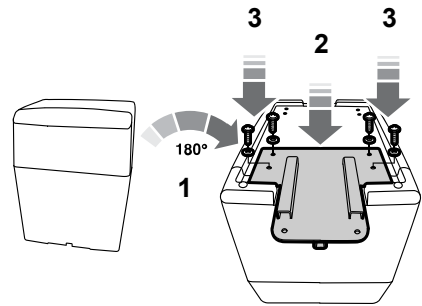

E76378

1. Turn the box over.
2. Position the load bracket.
3. Secure the load bracket with four screws.

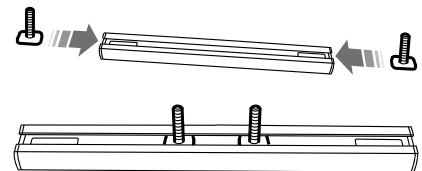

E76379

Load carrying

- Slide the captured bolts onto the load retaining fixture.

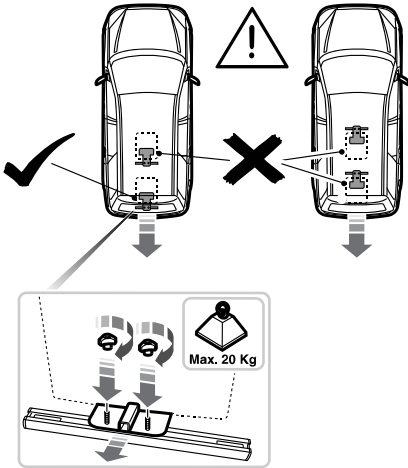

E76380

- Secure the load bracket with the two wing nuts.
- Remove in the reverse order.

Towing

TOWING A TRAILER

WARNINGS



Do not exceed 100 km/h (62 mph).



The rear tyre pressures must be increased by 0.2 bar (3 psi) above specification. See **Technical specifications** (page 231).



Do not exceed the maximum gross train weight stated on the vehicle identification plate. See **Vehicle identification** (page 234).

CAUTION



Do not exceed the maximum permissible nose weight, i.e. vertical weight on the tow ball, of 90 kilogrammes (198 pounds).

Note: *Not all vehicles are suitable or approved to have tow bars fitted. Check with your dealer first.*

Place loads as low and central to the axle(s) of the trailer as possible. If you are towing with an unladen vehicle, the load in the trailer should be placed toward the nose, within the maximum nose load, as this gives the best stability.

The stability of the vehicle to trailer combination is very much dependant on the quality of the trailer.

In high altitude regions above 1 000 metres (3 281 feet), the stipulated maximum permitted gross train weight must be reduced by 10% for every additional 1 000 metres (3 281 feet).

Steep gradients

WARNING



The overrun brake on a trailer is not controlled by ABS.

Change down a gear before you reach a steep downhill gradient.

DETACHABLE TOW BALL

WARNINGS



When not in use, always transport the tow ball arm securely fastened in the luggage compartment.



Take special care when fitting the tow ball arm as the safety of the vehicle and the trailer depends on this.



Do not use any tools for mounting or dismounting the tow ball arm. Do not modify the trailer coupling. Do not disassemble or repair the tow ball arm.

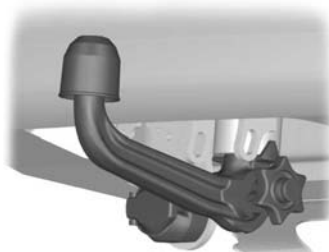

E71328

A 13-pin trailer socket and the tow ball arm seat are provided underneath the rear bumper. Turn the trailer socket down through 90 degrees until it engages in the end position.

Towing

Unlocking the tow ball arm mechanism

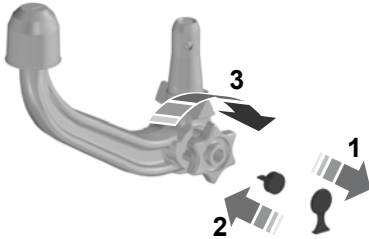

E71329

1. Remove the protecting cap (1). Insert the key and turn it clockwise to unlock (2).
2. Hold the tow ball arm. Pull the handwheel out and turn it clockwise until it clicks (3).
3. The red mark on the handwheel must align with the green mark on the tow ball.
4. Release the handwheel. The tow ball arm is unlocked.

Inserting the tow ball arm

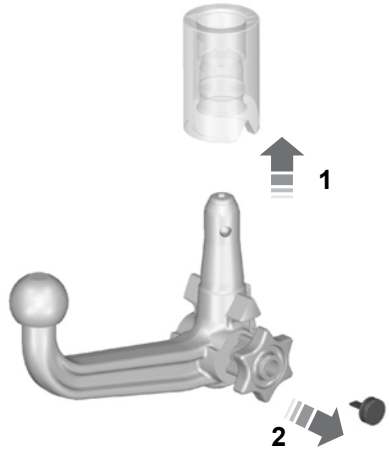

E71330

WARNING



The tow ball arm may only be inserted when completely unlocked.

1. Pull out the plug.
2. Insert the tow ball arm vertically and press it upwards until it engages (1). Do not hold your hand near the handwheel.
3. The green mark on the handwheel must align with the green mark on the tow ball.
4. To lock, turn the key anti-clockwise and remove the key (2).
5. Pull the protecting cap from the key bow and press it onto the lock.

Towing

Driving with a trailer

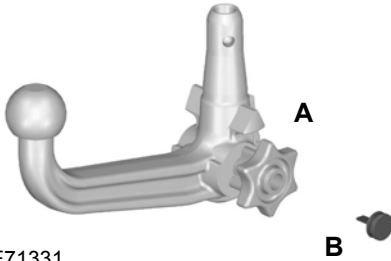

E71331

WARNING



If any of the below conditions cannot be met, do not use the tow bar and have it checked by a properly trained technician.

Before starting your journey, make sure that the tow ball arm is properly locked. Check:

- the green marks are aligned.
- the handwheel (**A**) is correctly fitted to the tow ball arm.
- you have removed the key (**B**).
- the tow ball arm is securely positioned. It must not move when jerked.

Removing the tow ball arm

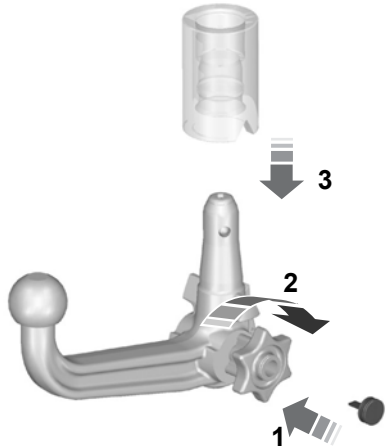

E71332

1. Unhitch the trailer.
2. Remove the protecting cap. Press the cap into the key bow. Insert the key and unlock (**1**).
3. Hold the tow ball arm. Pull the handwheel out, turn it clockwise against the stop (**2**) and remove the tow ball arm (**3**).
4. Release the handwheel.

When unlocked in this way, the tow ball arm can be reinserted at any time.

Towing

Driving without a trailer

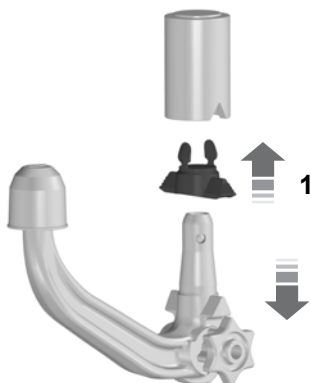

E94771

1. Remove the tow ball arm.
2. Insert the plug into its seat (1).

WARNING



Never unlock the tow ball arm with the trailer attached.

Maintenance

CAUTION



Remove the tow ball arm and protect the seat with the plug before steam cleaning your vehicle.

Keep the system clean. Periodically lubricate bearings, sliding surfaces, and locking balls with resin-free grease or oil and the lock with graphite.

Keep a note of the key number. In case of loss, replacement keys are available from the manufacturer by stating the 4-digit key number.

Driving hints

RUNNING-IN

Tyres

WARNING



New tyres need to be run-in for approximately 500 kilometres (300 miles). During this time, you may experience different driving characteristics.

Brakes and clutch

WARNING



Avoid heavy use of the brakes and clutch if possible for the first 150 kilometres (100 miles) in town and for the first 1 500 kilometres (1 000 miles) on motorways.

Engine

CAUTION



Avoid driving too fast during the first 1 500 kilometres (1 000 miles). Vary your speed frequently and change up through the gears early. Do not labour the engine.

GENERAL DRIVING POINTS - VEHICLES WITH: SPORTS SUSPENSION

The distance between the underside of your vehicle and the ground is reduced compared to other models. Drive with extreme care to avoid damage to your vehicle.

COLD WEATHER PRECAUTIONS

The functional operation of some components and systems can be affected at temperatures below -30°C (-22°F).

DRIVING THROUGH WATER

Driving through water

CAUTIONS



Drive through water in an emergency only, and not as part of normal driving.



Engine damage can occur if water enters the air filter.

In an emergency, the vehicle can be driven through water to a maximum depth of 200 mm and at a maximum speed of 10 km/h (6 mph). Extra caution should be exercised when driving through flowing water.

When driving in water, maintain a low speed and do not stop the vehicle. After driving through water, and as soon as it is safe to do so:

- Depress the brake pedal lightly and check that full brake function is achieved.
- Check that the horn works.
- Check that the vehicle's lights are fully operational.
- Check the power assistance of the steering system.

Emergency equipment

FIRST AID KIT

Space is provided in the luggage compartment.

4-door

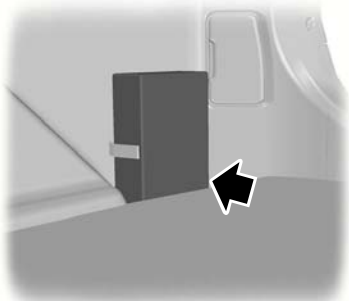

E87654

5-door

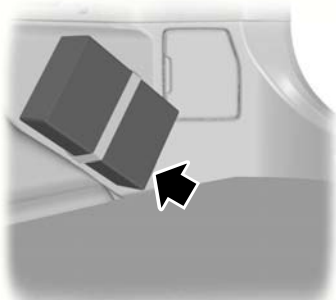

E87655

Estate

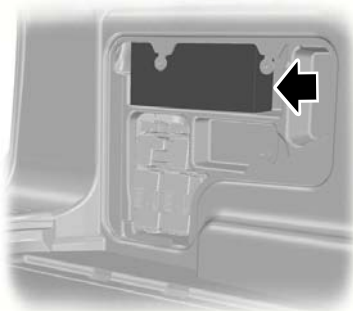

E87656

WARNING TRIANGLE

4-door and 5-door

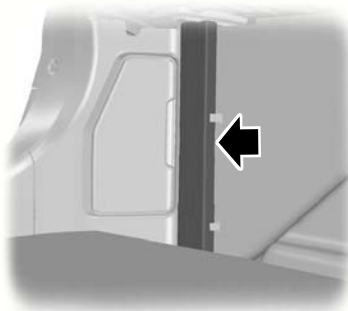

E87657

Space is provided in the luggage compartment.

Estate and vehicles with tyre repair kit

Space is provided under the carpet.

See **Rear under floor storage** (page 162).

Fuses

FUSE BOX LOCATIONS

Engine compartment fuse box



E72588

Central fuse box

All vehicles



E72589

1. Loosen the screws.

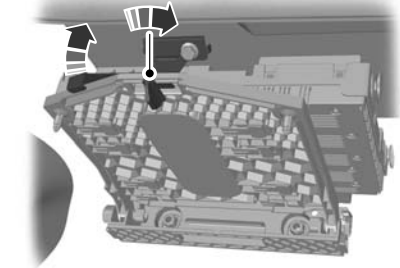

E72590

2. Turn the knob through 90 degrees and release the fuse box from the retaining bracket.

3. Lower the fuse box and pull it towards you.

Vehicles built up to: 07-02-2010

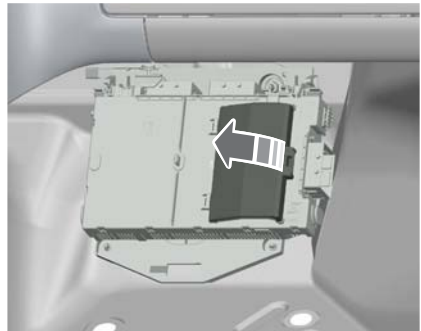

E72622

4. Remove the cover to gain access to the fuses (vehicles with a cooled glove box).

All vehicles

5. Install in the reverse order.

Fuses

Rear fuse box - 4-door and 5-door

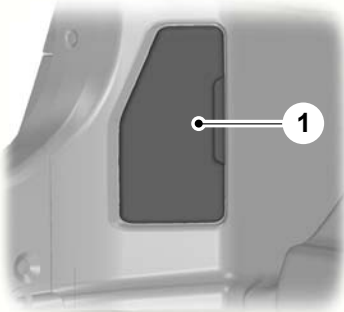

E87481

1. Remove the cover.

Rear fuse box - Estate

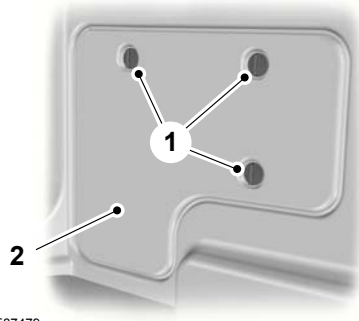

E87479

1. Release the catches.
2. Remove the cover.

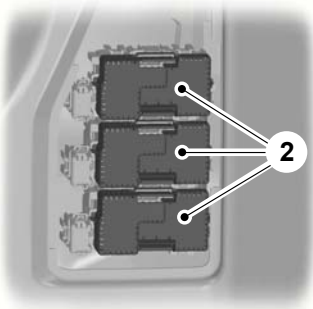

E87482

2. Remove the relevant fuse box cover.

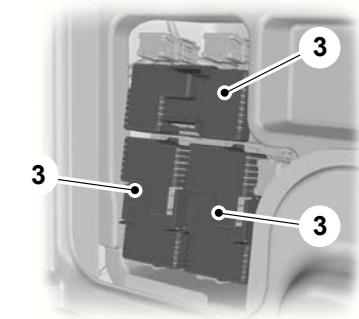

E87480

3. Remove the relevant fuse box cover.

Fuses

CHANGING A FUSE

WARNINGS



Do not modify the electrical system of your vehicle in any way. Have repairs to the electrical system and the replacement of relays and high current fuses carried out by a properly trained technician.



Switch the ignition and all electrical equipment off before touching or attempting to change a fuse.

CAUTION



Fit a replacement fuse with the same rating as the one you have removed.

Note: *You can identify a blown fuse by a break in the filament.*

Note: *All fuses, except high current fuses, are a push fit.*

Note: *A fuse puller is located in the engine compartment fuse box.*

Fuses

FUSE SPECIFICATION CHART - VEHICLES BUILT UP TO: 07-02-2010

Engine compartment fuse box

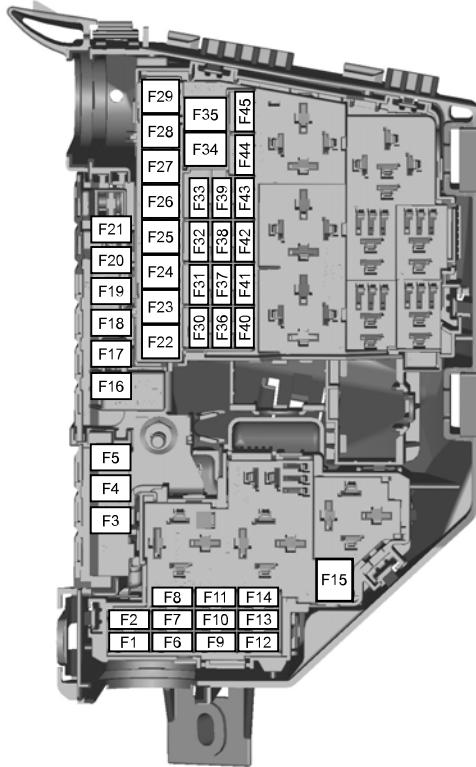

E75525

Fuse	Ampere rating	Colour	Circuits protected
F1	10	red	Transmission control module
F2	5	tan	Glow plug monitoring (diesel engines)

Fuses

Fuse	Ampere rating	Colour	Circuits protected
F3	70 ¹	brown	Engine cooling fan - twin fan (2.3L Duratec-HE)
F3	80 ¹	clear	Electric hydraulic power steering (EHPAS) (2.0L Duratorq-TDCi)
F4	60	yellow	Glow plugs
F5	60	yellow	Engine cooling fan
F6	10	red	HEGO sensors 1 (engine management), variable valve timing (engine management), CMS sensor, Oxygen sensor
F7	5	tan	Relay coils
F8	10	red	Powertrain control module
F9	10	red	MAF Sensor, Swirl Control Valve , Fuel Injectors, CCV PTC Heater, Variable Intake Valve, Variable Exhaust Valve (engine management)
F10	10	red	Engine control module
F11	10	red	PCV Valve, VCV Valve, Water in Fuel Sensor, Sonic Purge Valve, Swirl Control Valve, Variable Intake Valve, EGR Valve, IMVT Oil Control Valve (engine management)
F12	10	red	EGR Throttle, Variable Turbo Control Valve, Coil on Plug; Canister Purge Valve, Power Steering Pressure Switch (engine management)
F13	15	blue	Air conditioning relay
F14	15	blue	Diesel filter heater
F15	40	orange	Starter relay
F16	80	clear	Diesel auxiliary heater (PTC)
F17	60	yellow	Central fuse box supply A
F18	60	yellow	Central fuse box supply B
F19	60	yellow	Rear fuse box supply C
F20	60	yellow	Rear fuse box supply D

Fuses

Fuse	Ampere rating	Colour	Circuits protected
F21	–	–	Not used
F22	30	green	Windscreen wiper module
F23	25 ¹	clear	Heated rear window
F24	30	green	Headlamp washer
F25	30	green	ABS valves
F26	40	orange	ABS pump
F27	30	green	Fuel fired heater
F28	40	orange	Heater blower
F29	–	–	Not used
F30	–	–	Not used
F31	15	blue	Horn
F32	5	tan	Fuel fired heater - remote control
F33	5	tan	Light switch module, engine compartment fuse box coils
F34	40	orange	Heated windscreen (left-hand side)
F35	40	orange	Heated windscreen (right-hand side)
F36	5	tan	ABS
F37	10	red	Heated front washer jets
F38	5	tan	Adaptive cruise control (ACC)
F39	15	blue	Adaptive front lighting system (AFS)
F40	–	–	Not used
F41	20	yellow	Instrument panel
F42	10	red	Engine control module, transmission control module, electric hydraulic power steering (EHPAS) 15 feed
F43	5	tan	Headlamp levelling, adaptive front lighting system (AFS)
F44	-	-	Not used

Fuses

Fuse	Ampere rating	Colour	Circuits protected
F45	15	blue	Rear window wiper

¹Fit a replacement with the same rating as the one you have removed.

Central fuse box

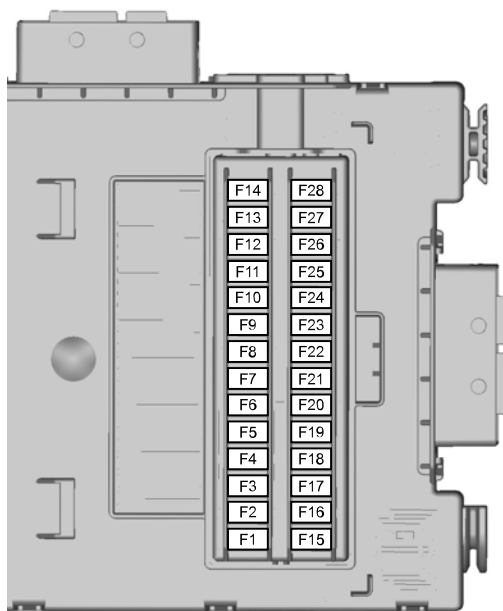

E75527

Fuse	Ampere rating	Colour	Circuits protected
F1	5	tan	Rain sensor
F2	10	red	SRS (airbag) supply
F3	7.5	brown	Yaw rate sensor (ESP), accelerator pedal supply

Fuses

Fuse	Ampere rating	Colour	Circuits protected
F4	7.5	brown	Electronic feed, electronic fuse
F5	-	-	Not used
F6	15	blue	Audio system (including voice control)
F7	7.5	brown	Steering wheel module
F8	5	tan	Instrument cluster
F9	15	blue	Main beam
F10	20	yellow	Power sunroof
F11	7.5	brown	Reversing lamps
F12	-	-	Not used
F13	15	blue	Front fog lamp
F14	15	blue	Windscreen washers
F15	10	red	Adaptive cruise control (ACC)
F16	-	-	Not used
F17	10	red	Interior lamps
F18	5	tan	Engine immobiliser
F19	15	blue	Cigar lighter
F20	-	-	Not used
F21	5	tan	Remote frequency receiver, Interior motion sensor
F22	20	yellow	Fuel pump
F22	7.5	brown	Fuel pump (2.2L Duratorq)
F23	-	-	Not used
F24	5	tan	Ignition switch
F25	10	red	Fuel filler flap
F26	5	tan	Battery backup sounder (alarm system), OBD II (board computer diagnostics)
F27	5	tan	Steering column unit, climate control module

Fuses

Fuse	Ampere rating	Colour	Circuits protected
F28	5	tan	Brake lamp switch

Rear fuse box 4-door and 5-door

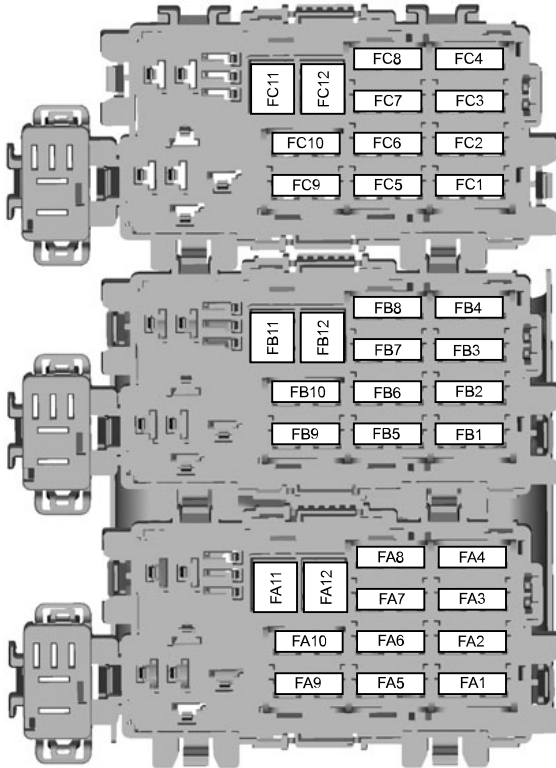

E87483

Fuses

Estate

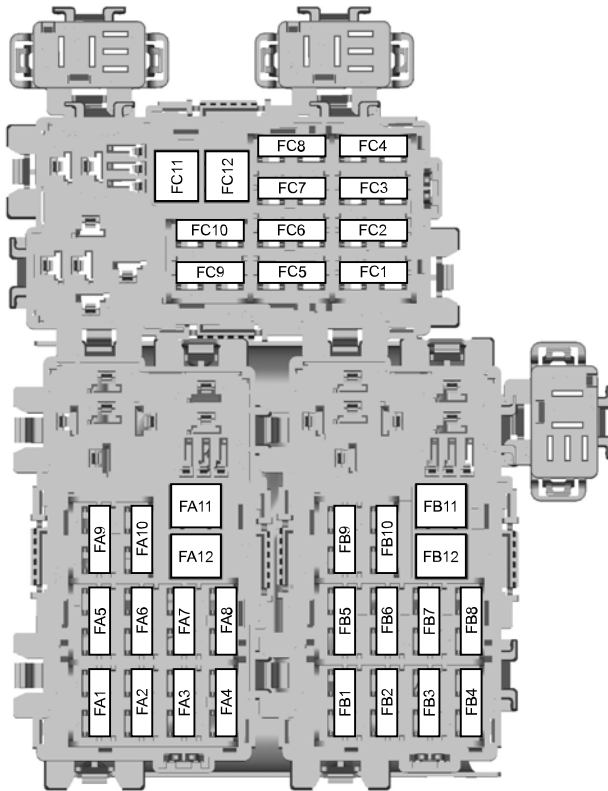

E75526

Fuse	Ampere rating	Colour	Circuits protected
FA1	25	clear	Door module (left-hand front) (window up/down, central locking, electric folding mirror, heated mirror)

Fuses

Fuse	Ampere rating	Colour	Circuits protected
FA2	25	clear	Door module (right-hand front) (window up/down, central locking, electric folding mirror, heated mirror)
FA3	25	clear	Door module (left-hand rear) (window up/down)
FA4	25	clear	Door module (right-hand rear) (window up/down)
FA5	10	red	Rear locking (without rear door modules)
FA6	15	blue	Auxiliary power socket
FA7	5	tan	Relay coils
FA8	20	yellow	Steering column lock
FA9	-	-	Not used
FA10	30	green	Electric driver's seat
FA11	20	yellow	Accessories, trailer module
FA12	-	-	Not used
FB1	5	tan	Parking aid module
FB2	15	blue	Suspension module
FB3	15	blue	Heated driver's seat
FB4	15	blue	Heated front passenger seat
FB5	15	blue	Left-hand rear heated seat
FB6	-	-	Not used
FB7	15	blue	Right-hand rear heated seat
FB8	-	-	Not used
FB9	30	green	Electric front passenger seat
FB10	10	red	Anti-theft alarm horn
FB11	-	-	Not used
FB12	-	-	Not used
FC1	-	-	Not used

Fuses

Fuse	Ampere rating	Colour	Circuits protected
FC2	-	-	Not used
FC3	-	-	Not used
FC4	-	-	Not used
FC5	7.5	brown	CD changer, rear seat entertainment system
FC6	-	-	Not used
FC7	5	tan	Seat memory function module
FC8	20	yellow	Keyless entry
FC9	-	-	Not used
FC10	-	-	Not used
FC11	-	-	Not used
FC12	-	-	Not used

Fuses

FUSE SPECIFICATION CHART - VEHICLES BUILT FROM: 08-02-2010

Engine compartment fuse box

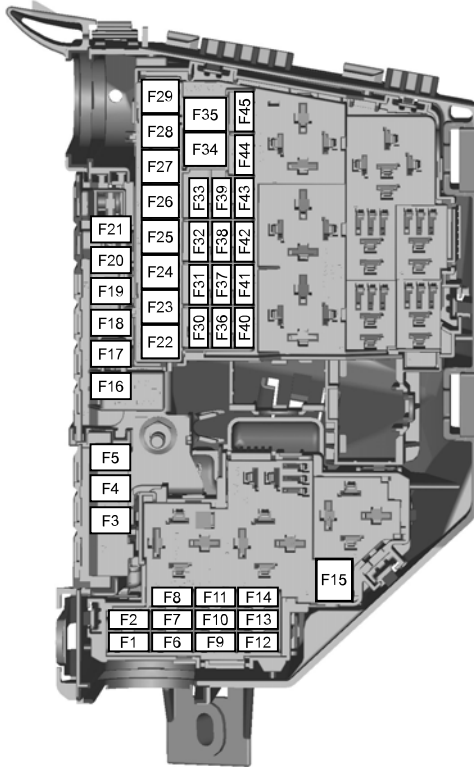

E75525

Fuse	Ampere rating	Colour	Circuits protected
F1	10	red	Transmission control module (AWF21)
F1	15	blue	Transmission control module (MPS6)

Fuses

Fuse	Ampere rating	Colour	Circuits protected
F2	5	tan	Glow plug monitoring (diesel engines)
F2	5	tan	Vaporiser glow plug monitoring (DW10c)
F3	70 ¹	brown	Engine cooling fan - twin fan (2.3L Duratec-HE)
F3	80 ¹	clear	Electric hydraulic power steering (EHPAS) (2.0L Duratorq-TDCi)
F4	60	yellow	Glow plugs
F5	60	yellow	Engine cooling fan
F6	10	red	HEGO sensors 1 (engine management), variable valve timing (engine management), CMS sensor, Oxygen sensor
F6	20	yellow	Vaporiser glow plug
F7	5	tan	Relay coils
F8	10	red	Powertrain control module
F8	20	yellow	Powertrain control module (2.0L EcoBoost SCTi, 2.0L Duratorq TDCi - DW10c)
F9	10	red	MAF Sensor, Swirl Control Valve, Fuel Injectors, CCV PTC Heater, Variable Intake Valve, Variable Exhaust Valve (engine management)
F9	5	tan	Fuel pump vaporiser (2.0L Duratorq TDCi - DW10c)
F10	10	red	Engine control module
F11	10	red	PCV Valve, VCV Valve, Water in Fuel Sensor, Sonic Purge Valve, Swirl Control Valve, Variable Intake Valve, EGR Valve, IVVT Oil Control Valve (engine management)
F11	5	tan	MAF sensor, Water in Fuel Sensor (DW10c)
F12	15	blue	Ignition coils (2.0L EcoBoost SCTi)

Fuses

Fuse	Ampere rating	Colour	Circuits protected
F12	10	red	EGR Throttle, Variable Turbo Control Valve, Coil on Plug; Canister Purge Valve, Power Steering Pressure Switch (engine management)
F12	5	tan	Relay coils (DW10c)
F13	15	blue	Air conditioning relay
F14	15	blue	Diesel filter heater
F14	20	yellow	Brake vacuum pump
F15	40	orange	Starter relay
F16	80	clear	Diesel auxiliary heater (PTC)
F17	60	yellow	Central fuse box supply A
F18	60	yellow	Central fuse box supply B
F19	60	yellow	Rear fuse box supply C
F20	60	yellow	Rear fuse box supply D
F21	–	–	Not used
F22	30	green	Windscreen wiper module
F23	25 ¹	clear	Heated rear window
F24	30	green	Headlamp washer
F25	30	green	ABS valves
F26	40	orange	ABS pump
F27	30	green	Fuel fired heater
F28	40	orange	Heater blower
F29	–	–	Not used
F30	–	–	Not used
F31	15	blue	Horn
F32	5	tan	Fuel fired heater - remote control
F33	5	tan	Light switch module, engine compartment fuse box coils

Fuses

Fuse	Ampere rating	Colour	Circuits protected
F34	40	orange	Heated windscreen (left-hand side)
F35	40	orange	Heated windscreen (right-hand side)
F36	5	tan	ABS
F37	10	red	Heated front washer jets
F38	5	tan	Adaptive cruise control (ACC)
F39	15	blue	Adaptive front lighting system (AFS)
F40	-	-	Not used
F41	20	yellow	Instrument panel
F42	10	red	Engine control module, transmission control module, electric hydraulic power steering (EHPAS) 15 feed
F43	5	tan	Headlamp levelling, adaptive front lighting system (AFS)
F44	-	-	Not used
F45	15	blue	Rear window wiper

¹Fit a replacement with the same rating as the one you have removed.

Fuses

Central fuse box

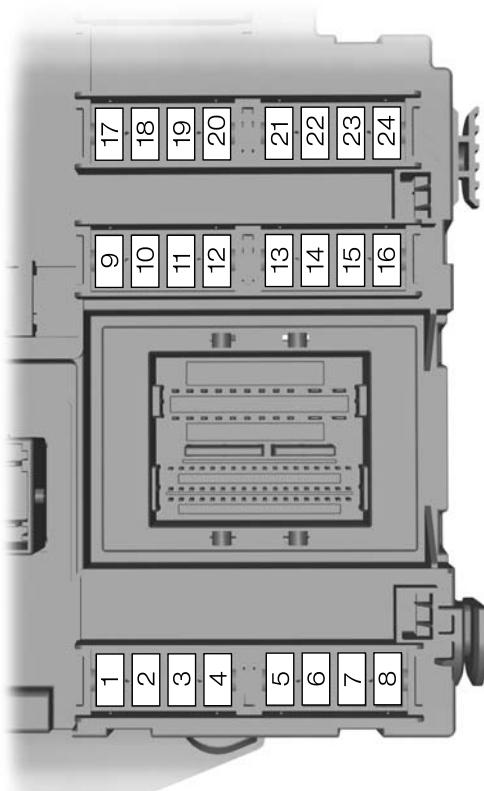

E124888

Fuse	Ampere rating	Colour	Circuits protected
F1	7.5	brown	Steering wheel module
F2	5	tan	Instrument cluster
F3	10	red	Interior lamps
F4	5	tan	Engine immobiliser

Fuses

Fuse	Ampere rating	Colour	Circuits protected
F5	7.5	brown	Adaptive cruise control (ACC)
F6	5	tan	Rain sensor
F7	15	blue	Cigar lighter
F8	10	red	Fuel filler flap unlock supply
F9	15	blue	Windscreen washers - rear
F10	15	blue	Windscreen washers - front
F11	10	red	Luggage compartment release supply
F12	10	red	Fuel filler flap lock supply
F13	20	yellow	Fuel pump
F13	7.5	brown	Fuel pump (2.2L Duratorq)
F14	5	tan	Remote frequency receiver, Interior motion sensor
F15	5	tan	Ignition switch
F16	5	tan	Battery backup sounder (alarm system), OBD II (board computer diagnostics)
F17	5	tan	Not used
F18	10	red	SRS (airbag) supply
F19	7.5	brown	ABS, yaw rate sensor (ESP), electric parking brake (EPB), accelerator pedal supply
F20	7.5	brown	Electronic feed, electronic fuse
F21	15	blue	Audio system (including voice control)
F22	5	tan	Brake lamp switch
F23	20	yellow	Sunroof
F24	5	tan	Steering column unit, climate control module

Fuses

Rear fuse box 4-door and 5-door

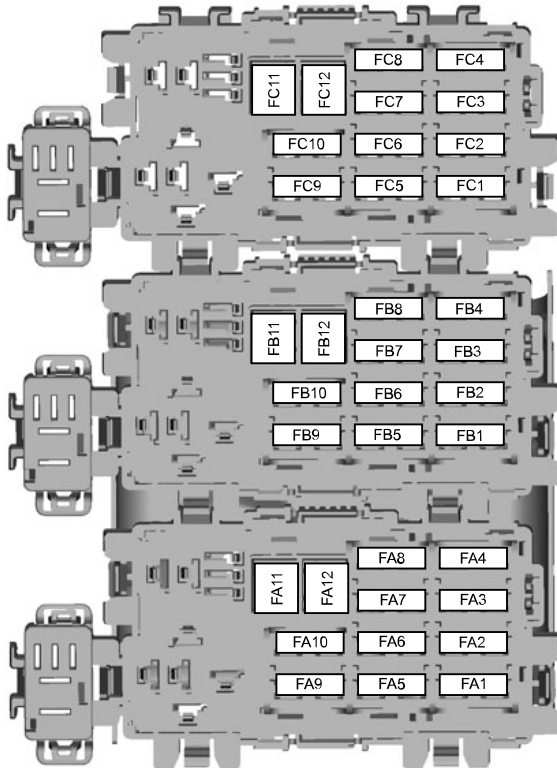

E87483

Fuses

Estate

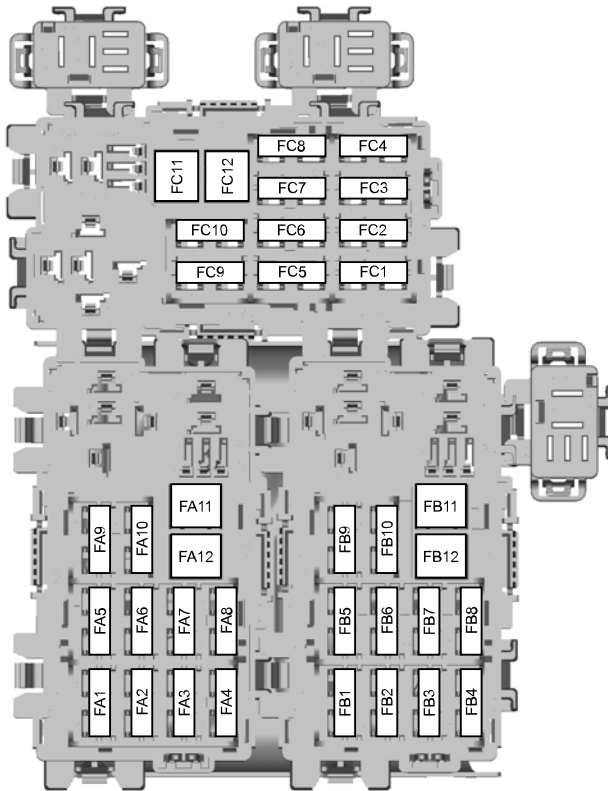

E75526

Fuse	Ampere rating	Colour	Circuits protected
FA1	25	clear	Door module (left-hand front) (window up/down, central locking, electric folding mirror, heated mirror)

Fuses

Fuse	Ampere rating	Colour	Circuits protected
FA2	25	clear	Door module (right-hand front) (window up/down, central locking, electric folding mirror, heated mirror)
FA3	25	clear	Door module (left-hand rear) (window up/down)
FA4	25	clear	Door module (right-hand rear) (window up/down)
FA5	10	red	Rear locking (without rear door modules)
FA6	15	blue	Auxiliary power socket
FA7	5	tan	Relay coils
FA8	20	yellow	Keyless vehicle module
FA9	-	-	Not used
FA10	30	green	Electric driver's seat
FA11	20	yellow	Accessories, trailer module
FA12	-	-	Not used
FB1	5	tan	Parking aid module
FB2	15	blue	Suspension module
FB3	15	blue	Heated driver's seat
FB4	15	blue	Heated front passenger seat
FB5	15	blue	Left-hand rear heated seat
FB6	-	-	Not used
FB7	15	blue	Right-hand rear heated seat
FB8	-	-	Not used
FB9	30	green	Electric front passenger seat
FB10	10	red	Anti-theft alarm horn
FB11	-	-	Not used
FB12	-	-	Not used
FC1	-	-	Not used

Fuses

Fuse	Ampere rating	Colour	Circuits protected
FC2	-	-	Not used
FC3	-	-	Not used
FC4	-	-	Not used
FC5	7.5	brown	CD changer, rear seat entertainment system
FC6	-	-	Not used
FC7	5	tan	Seat memory function module
FC8	20	yellow	Keyless entry
FC9	-	-	Not used
FC10	-	-	Not used
FC11	-	-	Not used
FC12	-	-	Not used

Vehicle recovery

TOWING POINTS

CAUTION

- ⚠ The screw-in towing eye has a **left-hand thread**. Turn it **anti-clockwise** to install it.

The screw-in towing eye is located in the spare wheel well.

The towing eye must **always** be carried in the vehicle.

Front towing eye

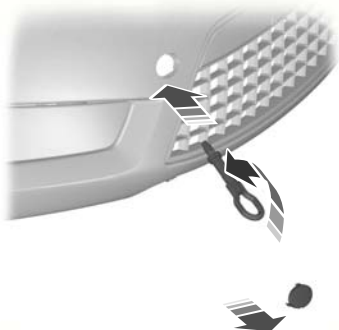

E87280

Rear towing eye



E87282

Insert your finger into the hole on the underside of the cover and prise off the cover. Install the towing eye.

TOWING THE VEHICLE ON FOUR WHEELS

All vehicles

WARNINGS

- ⚠ Switch the ignition on when your vehicle is being towed. The steering lock will engage and the direction indicators and brake lamps will not work if you do not.

- ⚠ The brake servo and the power steering pump do not operate unless the engine is running. Press the brake pedal harder and allow for increased stopping distances and heavier steering.

CAUTIONS

- ⚠ Too much tension in the tow rope could cause damage to your vehicle or the vehicle that is towing.
- ⚠ Do not use a rigid tow bar on the front towing eye.

Drive off slowly and smoothly without jerking the vehicle that is towing.





Vehicles with automatic transmission, except 2.0L Duratorq-TDCi (DW) Diesel (Stage V) or 2.0L EcoBoost SCTi (MI4) with 6-Speed Automatic Transmission

CAUTIONS

- ⚠ Do not tow your vehicle faster than 50 km/h (30 mph) or further than 50 kilometres (30 miles).







Vehicle recovery

CAUTIONS

-  If a speed of 50 km/h (30 mph) and a distance of 50 kilometres (30 miles) is to be exceeded the drive wheels must be lifted clear of the ground.
 -  In the event of a mechanical failure of the transmission the drive wheels must be lifted clear of the ground.
 -  Do not tow your vehicle backwards.
 -  Select neutral when your vehicle is being towed.
-

Vehicles with 2.0L Duratorq-TDCi (DW) Diesel (Stage V) or 2.0L EcoBoost SCTi (MI4) and 6-Speed Automatic Transmission

CAUTIONS

-  It is recommended not to tow with the drive wheels on the ground. However, if it is required to move the vehicle from a dangerous location, do not tow your vehicle faster than 20 km/h (12 mph) or further than 20 kilometres (12 miles).
 -  If a speed of 20 km/h (12 mph) and a distance of 20 kilometres (12 miles) is to be exceeded the drive wheels must be lifted clear of the ground.
 -  Do not tow your vehicle if the ambient temperature is below 0°C (32°F).
 -  Do not tow your vehicle backwards.
 -  In the event of a mechanical failure of the transmission the drive wheels must be lifted clear of the ground.
 -  Select neutral when your vehicle is being towed.
-

Maintenance

GENERAL INFORMATION

Have your vehicle serviced regularly to help maintain its roadworthiness and resale value. There is a large network of Ford Authorised Repairers that are there to help you with their professional servicing expertise. We believe that their specially trained technicians are best qualified to service your vehicle properly and expertly. They are supported by a wide range of highly specialised tools developed specifically for servicing your vehicle.

In addition to regular servicing, we recommend that you carry out the following additional checks.

WARNINGS



Switch the ignition off before touching or attempting adjustment of any kind.



Do not touch the electronic ignition system parts after you have switched the ignition on or when the engine is running. The system operates at high voltage.



Keep your hands and clothing clear of the engine cooling fan. Under certain conditions, the fan may continue to run for several minutes after you have switched the engine off.

CAUTION



When carrying out maintenance checks, make sure that filler caps are fitted securely.

Daily checks

- Exterior lamps.
- Interior lamps.
- Warning lamps and indicators.

Check when refuelling

- Engine oil level. See **Engine oil check** (page 210).
- Brake fluid level. See **Brake and clutch fluid check** (page 211).
- Washer fluid level. See **Washer fluid check** (page 211).
- Tyre pressures (when cold). See **Technical specifications** (page 231).
- Tyre condition. See **Tyre care** (page 229).

Monthly checks

- Engine coolant level (engine cold). See **Engine coolant check** (page 210).
- Pipes, hoses and reservoirs for leaks.
- Power steering fluid level. See **Power steering fluid check** (page 211).
- Air conditioning operation.
- Parking brake operation.
- Horn operation.
- Tightness of wheel nuts. See **Technical specifications** (page 231).

Maintenance

OPENING AND CLOSING THE BONNET

Opening the bonnet



Raise the bonnet slightly and move the catch upwards.

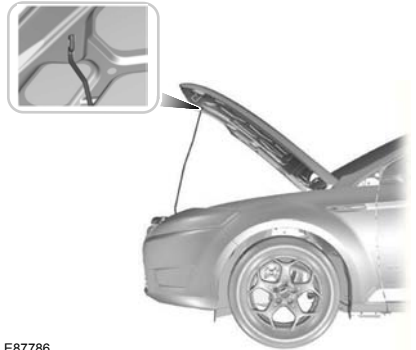

Open the bonnet and support it with the strut.

Closing the bonnet

WARNING



Make sure that the bonnet is closed properly.

Lower the bonnet and allow it to drop from under its own weight for the last 20 - 30 centimetres (8 - 11 inches).

Maintenance

ENGINE COMPARTMENT OVERVIEW - 1.6L DURATEC-16V TI-VCT (SIGMA)

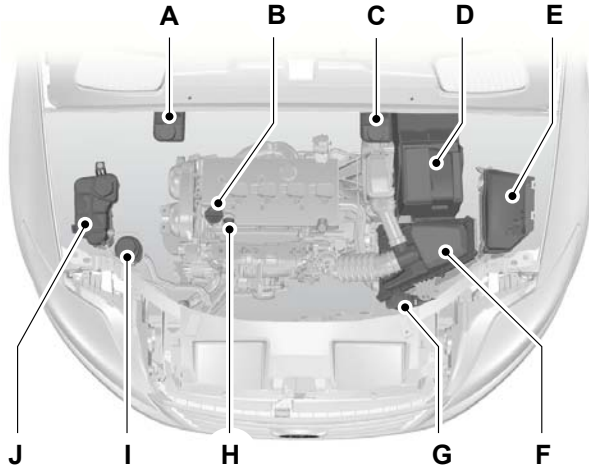

E87714

- A Brake and clutch fluid reservoir (right-hand drive). See **Brake and clutch fluid check** (page 211).
- B Engine oil filler cap¹. See **Engine oil check** (page 210).
- C Brake and clutch fluid reservoir (left-hand drive). See **Brake and clutch fluid check** (page 211).
- D Battery. See **Vehicle battery** (page 217).
- E Engine compartment fuse box. See **Fuses** (page 174).
- F Air cleaner. No maintenance necessary.
- G Screen washer fluid reservoir. See **Washer fluid check** (page 211).
- H Engine oil dipstick¹. See **Engine oil check** (page 210).
- I Power steering fluid reservoir. See **Power steering fluid check** (page 211).
- J Engine coolant reservoir. See **Engine coolant check** (page 210).

¹The filler caps and the engine oil dipstick are coloured for easy identification.

Maintenance

ENGINE COMPARTMENT OVERVIEW - 2.0L DURATEC-HE (MI4)

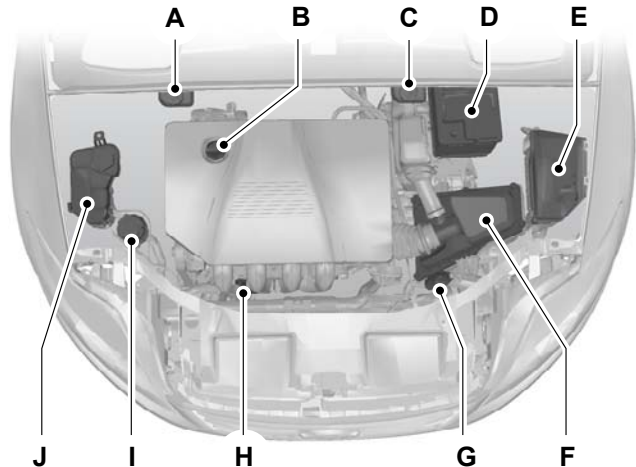

E73231

- A Brake and clutch fluid reservoir (right-hand drive). See **Brake and clutch fluid check** (page 211).
- B Engine oil filler cap¹. See **Engine oil check** (page 210).
- C Brake and clutch fluid reservoir (left-hand drive). See **Brake and clutch fluid check** (page 211).
- D Battery. See **Using booster cables** (page 217).
- E Engine compartment fuse box. See **Fuse specification chart** (page 177).
- F Air cleaner. No maintenance necessary.
- G Screen washer fluid reservoir. See **Washer fluid check** (page 211).
- H Engine oil dipstick¹. See **Engine oil check** (page 210).
- I Power steering fluid reservoir. See **Power steering fluid check** (page 211).
- J Engine coolant reservoir. See **Engine coolant check** (page 210).

¹The filler caps and the engine oil dipstick are coloured for easy identification.

Maintenance

ENGINE COMPARTMENT OVERVIEW - 2.0L ECOBOOST SCTI (MI4)

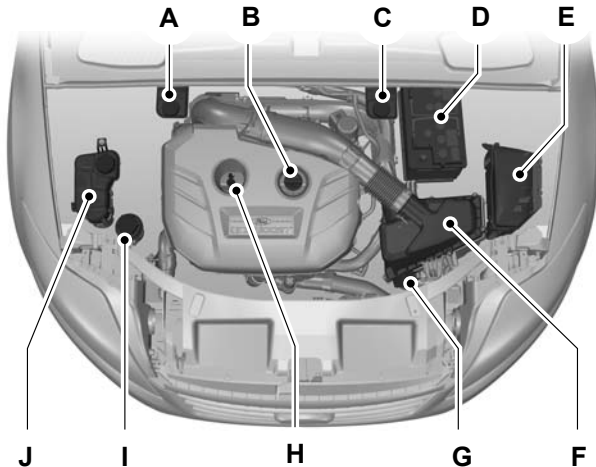

E124921

- A Brake and clutch fluid reservoir (right-hand drive). See **Brake and clutch fluid check** (page 211).
- B Engine oil filler cap¹. See **Engine oil check** (page 210).
- C Brake and clutch fluid reservoir (left-hand drive). See **Brake and clutch fluid check** (page 211).
- D Battery. See **Using booster cables** (page 217).
- E Engine compartment fuse box. See **Fuse specification chart** (page 186).
- F Air cleaner. No maintenance necessary.
- G Screen washer fluid reservoir. See **Washer fluid check** (page 211).
- H Engine oil dipstick¹. See **Engine oil check** (page 210).
- I Power steering fluid reservoir. See **Power steering fluid check** (page 211).
- J Engine coolant reservoir. See **Engine coolant check** (page 210).

¹The filler caps and the engine oil dipstick are coloured for easy identification.

Maintenance

ENGINE COMPARTMENT OVERVIEW - 2.3L DURATEC-HE (MI4)

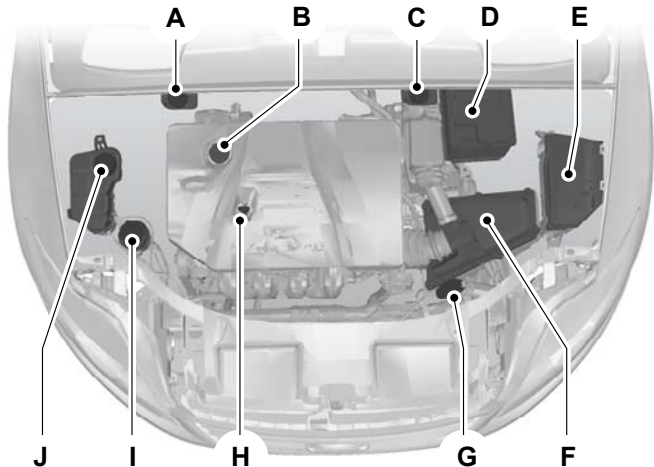

E81313

- A Brake and clutch fluid reservoir (right-hand drive). See **Brake and clutch fluid check** (page 211).
- B Engine oil filler cap¹. See **Engine oil check** (page 210).
- C Brake and clutch fluid reservoir (left-hand drive). See **Brake and clutch fluid check** (page 211).
- D Battery. See **Using booster cables** (page 217).
- E Engine compartment fuse box. See **Fuse specification chart** (page 177).
- F Air cleaner. No maintenance necessary.
- G Screen washer fluid reservoir. See **Washer fluid check** (page 211).
- H Engine oil dipstick¹. See **Engine oil check** (page 210).
- I Power steering fluid reservoir. See **Power steering fluid check** (page 211).
- J Engine coolant reservoir. See **Engine coolant check** (page 210).

¹The filler caps and the engine oil dipstick are coloured for easy identification.

Maintenance

ENGINE COMPARTMENT OVERVIEW - 2.5L DURATEC (VI5)

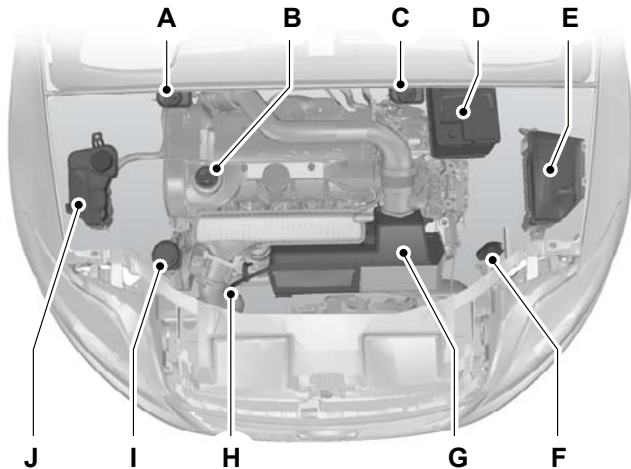

E73232

- A Brake and clutch fluid reservoir (right-hand drive). See **Brake and clutch fluid check** (page 211).
- B Engine oil filler cap¹. See **Engine oil check** (page 210).
- C Brake and clutch fluid reservoir (left-hand drive). See **Brake and clutch fluid check** (page 211).
- D Battery. See **Using booster cables** (page 217).
- E Engine compartment fuse box. See **Fuse specification chart** (page 177).
- F Screen washer fluid reservoir. See **Washer fluid check** (page 211).
- G Air cleaner. No maintenance necessary.
- H Engine oil dipstick¹. See **Engine oil check** (page 210).
- I Power steering fluid reservoir. See **Power steering fluid check** (page 211).
- J Engine coolant reservoir. See **Engine coolant check** (page 210).

¹The filler caps and the engine oil dipstick are coloured for easy identification.

Maintenance

ENGINE COMPARTMENT OVERVIEW - 1.8L DURATORQ-TDCI (LYNX) DIESEL

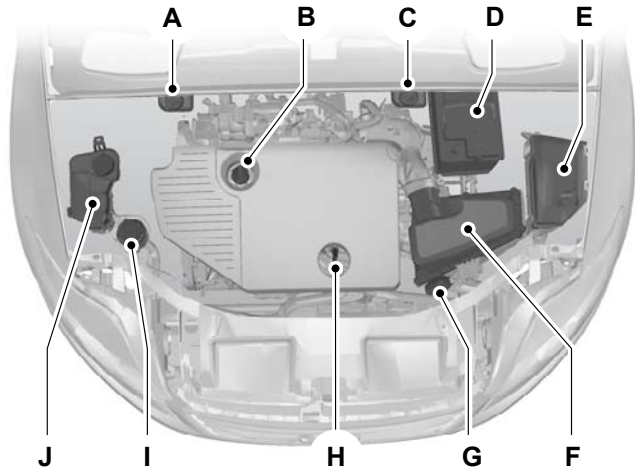

E73233

- A Brake and clutch fluid reservoir (right-hand drive). See **Brake and clutch fluid check** (page 211).
- B Engine oil filler cap¹. See **Engine oil check** (page 210).
- C Brake and clutch fluid reservoir (left-hand drive). See **Brake and clutch fluid check** (page 211).
- D Battery. See **Using booster cables** (page 217).
- E Engine compartment fuse box. See **Fuse specification chart** (page 177).
- F Air cleaner. No maintenance necessary.
- G Screen washer fluid reservoir. See **Washer fluid check** (page 211).
- H Engine oil dipstick¹. See **Engine oil check** (page 210).
- I Power steering fluid reservoir. See **Power steering fluid check** (page 211).
- J Engine coolant reservoir. See **Engine coolant check** (page 210).

¹The filler caps and the engine oil dipstick are coloured for easy identification.

Maintenance

ENGINE COMPARTMENT OVERVIEW - 2.0L DURATORQ-TDCI (DW) DIESEL

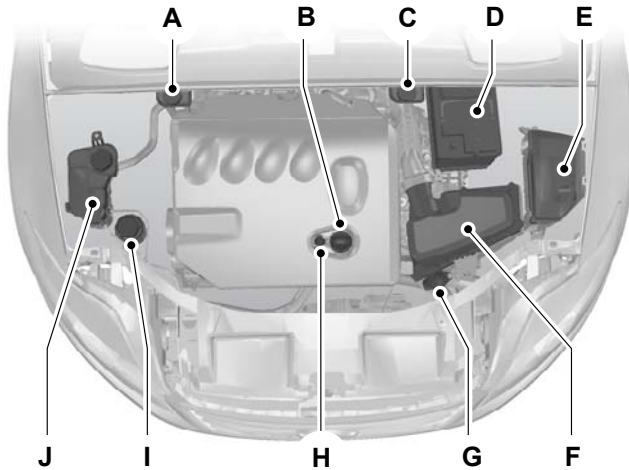

E73234

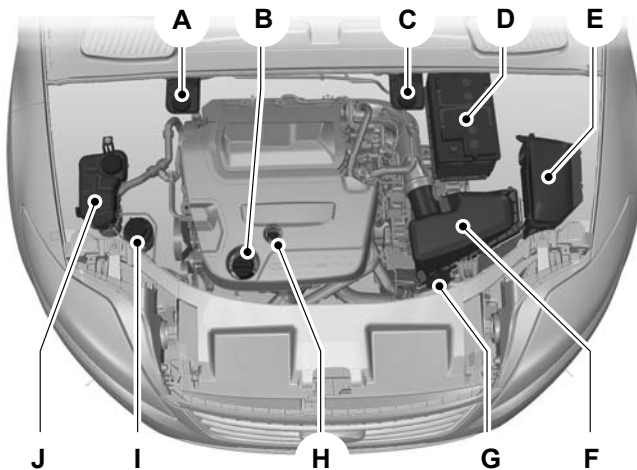

E124913

Maintenance

- A Brake and clutch fluid reservoir (right-hand drive). See **Brake and clutch fluid check** (page 211).
- B Engine oil filler cap¹. See **Engine oil check** (page 210).
- C Brake and clutch fluid reservoir (left-hand drive). See **Brake and clutch fluid check** (page 211).
- D Battery. See **Using booster cables** (page 217).
- E Engine compartment fuse box. See **Fuse specification chart** (page 186).
- F Air cleaner. No maintenance necessary.
- G Screen washer fluid reservoir. See **Washer fluid check** (page 211).
- H Engine oil dipstick¹. See **Engine oil check** (page 210).
- I Power steering fluid reservoir. See **Power steering fluid check** (page 211).
- J Engine coolant reservoir. See **Engine coolant check** (page 210).

¹The filler caps and the engine oil dipstick are coloured for easy identification.

ENGINE COMPARTMENT OVERVIEW - 2.2L DURATORQ-TDCI (DW) DIESEL

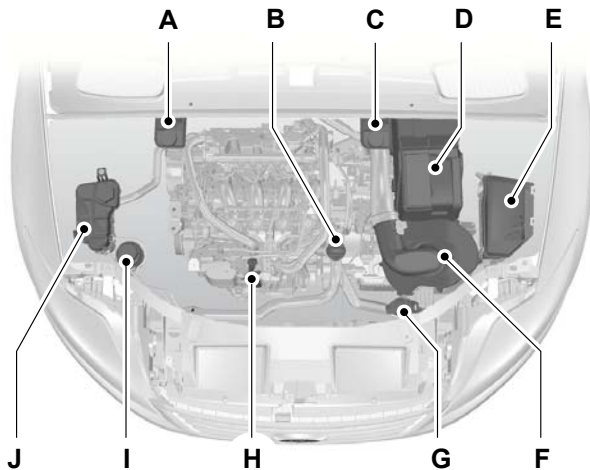

E87715

Maintenance

- A Brake and clutch fluid reservoir (right-hand drive): See **Brake and clutch fluid check** (page 211).
- B Engine oil filler cap¹: See **Engine oil check** (page 210).
- C Brake and clutch fluid reservoir (left-hand drive): See **Brake and clutch fluid check** (page 211).
- D Battery: See **Vehicle battery** (page 217).
- E Engine compartment fuse box: See **Fuses** (page 174).
- F Air cleaner: No maintenance necessary.
- G Screen washer fluid reservoir: See **Washer fluid check** (page 211).
- H Engine oil dipstick¹: See **Engine oil check** (page 210).
- I Power steering fluid reservoir: See **Power steering fluid check** (page 211).
- J Engine coolant reservoir: See **Engine coolant check** (page 210).

¹The filler caps and the engine oil dipstick are coloured for easy identification.

ENGINE OIL DIPSTICK - 1.6L DURATEC-16V TI-VCT (SIGMA)

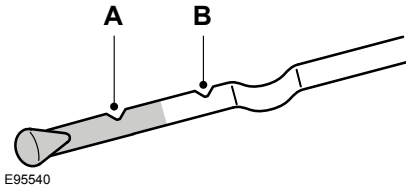

- A MIN
- B MAX

ENGINE OIL DIPSTICK - 2.0L DURATEC-HE (MI4)/2.3L DURATEC-HE (MI4)

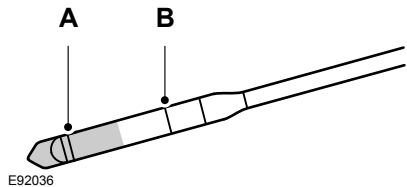

- A MIN
- B MAX

Maintenance

ENGINE OIL DIPSTICK - 2.0L ECOBOOST SCTI (MI4)

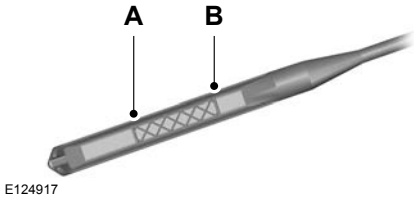

- A MIN
- B MAX

ENGINE OIL DIPSTICK - 2.5L DURATEC (VI5)

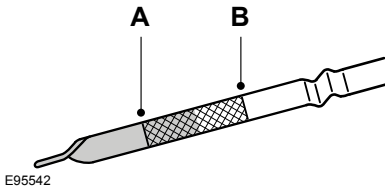

- A MIN
- B MAX

ENGINE OIL DIPSTICK - 1.8L DURATORQ-TDCI (LYNX) DIESEL

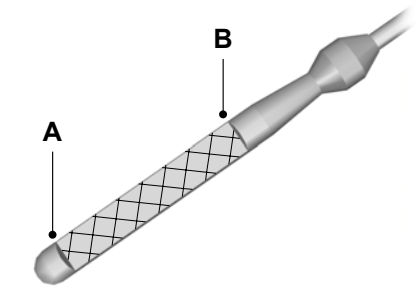

- A MIN
- B MAX

ENGINE OIL DIPSTICK - 2.0L DURATORQ-TDCI (DW) DIESEL/2.2L DURATORQ- TDCI (DW) DIESEL

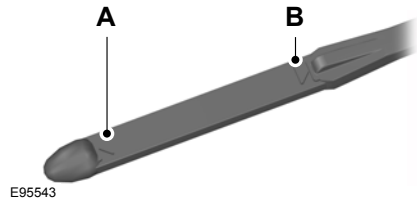

- A MIN
- B MAX

Maintenance

ENGINE OIL CHECK

CAUTION

 Do not use oil additives or other engine treatments. Under certain conditions, they could damage the engine.

Note: *The oil consumption of new engines reaches its normal level after approximately 5 000 kilometres (3 000 miles).*

Checking the oil level

CAUTION

 Make sure that the level is between the **MIN** and the **MAX** marks.

Note: *Check the level before starting the engine.*

Note: *Make sure that your vehicle is on level ground.*

Note: *Oil expands when it is hot. The level may therefore extend a few millimetres beyond the **MAX** mark.*

Remove the dipstick and wipe it with a clean, lint free cloth. Replace the dipstick and remove it again to check the oil level.

If the level is at the **MIN** mark, top up immediately.

Topping up

WARNINGS

 Only top up when the engine is cold. If the engine is hot, wait 10 minutes for the engine to cool down.

 Do not remove the filler cap when the engine is running.

Remove the filler cap.

CAUTION

 Do not top up further than the **MAX** mark.

Top up with fluid that meets the Ford specification. See **Technical specifications** (page 212).

ENGINE COOLANT CHECK

Checking the coolant level

WARNING

 Do not allow the fluid to touch your skin or eyes. If this happens, rinse the affected areas immediately with plenty of water and contact your doctor.

CAUTION

 Make sure that the level is between the **MIN** and the **MAX** marks.

Note: *Coolant expands when it is hot. The level may therefore extend beyond the **MAX** mark.*

If the level is at the **MIN** mark, top up immediately.

Topping up

WARNINGS

 Only top up when the engine is cold. If the engine is hot, wait 10 minutes for the engine to cool down.

 Do not remove the filler cap when the engine is running.

 Do not remove the filler cap when the engine is hot. Wait for the engine to cool down.

 Undiluted coolant is flammable and may ignite if spilt on a hot exhaust.

Maintenance

CAUTIONS

 In an emergency, you can add just water to the cooling system to reach a vehicle service station. The system must then be drained and refilled with a 50/50 mixture of coolant and water. Have the system checked by a properly trained technician as soon as possible.

 Increased dilution of the coolant can cause engine damage from corrosion, overheating or freezing.

Unscrew the cap **slowly**. Any pressure will escape slowly as you unscrew the cap.

CAUTION

 Do not top up further than the **MAX** mark.

Top up with a 50/50 mixture of coolant and water using fluid that meets the Ford specification. See **Technical specifications** (page 212).

BRAKE AND CLUTCH FLUID CHECK

WARNINGS

 Do not allow the fluid to touch your skin or eyes. If this happens, rinse the affected areas immediately with plenty of water and contact your doctor.

 If the level is at the **MIN** mark, have the system checked by a properly trained technician as soon as possible.

Note: *The brake and the clutch systems are supplied from the same reservoir.*

Top up with fluid that meets the Ford specification. See **Technical specifications** (page 212).

POWER STEERING FLUID CHECK

WARNING

 Do not allow the fluid to touch your skin or eyes. If this happens, rinse the affected areas immediately with plenty of water and contact your doctor.

CAUTION

 Make sure that the level is between the **MIN** and the **MAX** marks.

If the level is at the **MIN** mark, top up immediately.

Topping up

Remove the filler cap.

CAUTION

 Do not top up further than the **MAX** mark.

Top up with fluid that meets the Ford specification. See **Technical specifications** (page 212).

WASHER FLUID CHECK

The front and rear washer systems are supplied from the same reservoir.

Maintenance

TECHNICAL SPECIFICATIONS

Vehicle fluids

Item	Recommended fluid	Specification
Engine oil	Castrol Engine Oil*	WSS-M2C913-C
Power steering fluid	Ford or Motorcraft Power Steering Fluid	WSS-M2C204-A2
Coolant	Motorcraft SuperPlus Anti-freeze	WSS-M97B44-D
Brake fluid	Ford or Motorcraft Super DOT 4 Brake Fluid	ESD-M6C57-A

* Providing it meets the specification defined by **WSS-M2C913-C**, you can also use Ford Engine Oil or an alternative engine oil.

Topping up the oil: If you are unable to find an oil that meets the specification defined by **WSS-M2C913-C**, you must use **SAE 5W-30** (preferred), **SAE 5W-40** (except vehicles with E85 fuel) or **SAE 10W-40** that meets the specification defined by either **ACEA A5/B5** (preferred) or **ACEA A3/B3**. Using these oils can result in longer engine cranking periods, reduced engine performance, reduced fuel economy and increased emission levels.

Castrol engine oil recommended.



Capacities

Variant	Item	Capacity in litres (gallons)
All	Power steering system	MAX mark
All	Windscreen and rear window washer system	3.8 (0.8)
1.6L Duratec-16V Ti-VCT	Engine lubrication system - including the oil filter	4.1 (0.9)
1.6L Duratec-16V Ti-VCT	Engine lubrication system - excluding the oil filter	3.8 (0.8)
1.6L Duratec-16V Ti-VCT	Engine cooling system	6.0 (1.3)

Maintenance

Variant	Item	Capacity in litres (gallons)
1.6L Duratec-16V Ti-VCT	Fuel tank	70 (15.4)
2.0L Duratec-HE	Engine lubrication system - including the oil filter	4.3 (1.0)
2.0L Duratec-HE	Engine lubrication system - excluding the oil filter	3.9 (0.9)
2.0L Duratec-HE	Engine cooling system	6.2 (1.4)
2.0L Duratec-HE	Fuel tank	70 (15.4)
2.0L EcoBoost SCTi	Engine lubrication system - including the oil filter	5.4 (1.2)
2.0L EcoBoost SCTi	Engine lubrication system - excluding the oil filter	5.1 (1.1)
2.0L EcoBoost SCTi	Engine cooling system	approx. 6.9 (1.5)
2.0L EcoBoost SCTi	Fuel tank	70 (15.4)
2.3L Duratec-HE	Engine lubrication system - including the oil filter	4.3 (1.0)
2.3L Duratec-HE	Engine lubrication system - excluding the oil filter	3.9 (0.9)
2.3L Duratec-HE	Engine cooling system	6.9 (1.5)
2.3L Duratec-HE	Fuel tank	70 (15.4)
2.5L Duratec-ST	Engine lubrication system - including the oil filter	5.8 (1.3)
2.5L Duratec-ST	Engine lubrication system - excluding the oil filter	5.5 (1.2)
2.5L Duratec-ST	Engine cooling system	7.1 (1.6)
2.5L Duratec-ST	Fuel tank	70 (15.4)
1.8L Duratorq-TDCi	Engine lubrication system - including the oil filter	5.6 (1.2)
1.8L Duratorq-TDCi	Engine lubrication system - excluding the oil filter	5.0 (1.1)
1.8L Duratorq-TDCi	Engine cooling system	7.9 (1.7)
1.8L Duratorq-TDCi	Fuel tank	70 (15.4)

Maintenance

Variant	Item	Capacity in litres (gallons)
2.0L Duratorq-TDCi	Engine lubrication system - including the oil filter	5.5 (1.2)
2.0L Duratorq-TDCi	Engine lubrication system - excluding the oil filter	5.0 (1.1)
2.0L Duratorq-TDCi	Engine cooling system	8.1 (1.8)
2.0L Duratorq-TDCi	Fuel tank	70 (15.4)
2.2L Duratorq-TDCi	Engine lubrication system - including the oil filter	6.0 (1.3)
2.2L Duratorq-TDCi	Engine lubrication system - excluding the oil filter	5.4 (1.2)
2.2L Duratorq-TDCi	Engine cooling system	8.4 (1.9)
2.2L Duratorq-TDCi	Fuel tank	70 (15.4)

Vehicle care

CLEANING THE EXTERIOR

WARNING



If you use a car wash with a waxing cycle, make sure that you remove the wax from the windscreen.

CAUTIONS



Prior to using a car wash facility check the suitability of it for your vehicle.



Some car wash installations use water at high pressure. This could damage certain parts of your vehicle.



Remove the aerial before using an automatic car wash.



Switch the heater blower off to prevent contamination of the fresh air filter.

We recommend that you wash your vehicle with a sponge and lukewarm water containing a car shampoo.

Cleaning the headlamps

CAUTIONS



Do not scrape the headlamp lenses or use abrasives, alcoholic solvents or chemical solvents to clean them.



Do not wipe the headlamps when they are dry.

Cleaning the rear window

CAUTION



Do not scrape the inside of the rear window or use abrasives or chemical solvents to clean it.

Use a clean, lint free cloth or a damp chamois leather to clean the inside of the rear window.

Cleaning the chrome trim

CAUTION



Do not use abrasives or chemical solvents. Use soapy water.

Body paintwork preservation

CAUTIONS



Do not polish your vehicle in strong sunshine.



Do not allow polish to touch plastic surfaces. It could be difficult to remove.



Do not apply polish to the windscreen or rear window. This could cause the wipers to become noisy and they may not clear the window properly.

We recommend that you wax the paintwork once or twice a year.

CLEANING THE INTERIOR

Seat belts

WARNINGS



Do not use abrasives, or chemical solvents to clean them.



Do not allow moisture to penetrate the seat belt retractor mechanism.

Clean the seat belts with interior cleaner or water applied with a soft sponge. Let the seat belts dry naturally, away from artificial heat.

Vehicle care

Instrument cluster screens, LCD screens, radio screens

WARNING



Do not use abrasives, alcoholic solvents or chemical solvents to clean them.

REPAIRING MINOR PAINT DAMAGE

CAUTION



Remove apparently harmless looking substances from the paintwork immediately (e.g. bird droppings, tree resins, insect remains, tar spots, road salt and industrial fall out).

You should repair paintwork damage caused by stones from the road or minor scratches as soon as possible. A choice of products is available from your Ford Dealer. Read and follow the manufacturer's instructions.

Vehicle battery

USING BOOSTER CABLES

CAUTIONS

- ⚠ Connect batteries with only the same nominal voltage.
- ⚠ Always use booster cables with insulated clamps and adequate size cable.
- ⚠ Do not disconnect the battery from the vehicle's electrical system.

To connect the booster cables

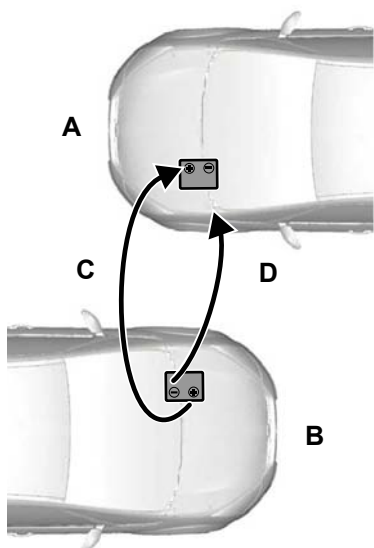

E102925

- A Flat battery vehicle
- B Booster battery vehicle
- C Positive connection cable
- D Negative connection cable

1. Position the vehicles so that they do not touch one another.
2. Switch off the engine and any electrical equipment.
3. Connect the positive (+) terminal of vehicle **B** with the positive (+) terminal of vehicle **A** (cable **C**).
4. Connect the negative (-) terminal of vehicle **B** to the ground connection of vehicle **A** (cable **D**). See **Battery connection points** (page 218).

CAUTIONS

- ⚠ **Do not connect to the negative (-) terminal of the flat battery.**
- ⚠ Make sure that the cables are clear of any moving parts.

To start the engine

1. Run the engine of vehicle **B** at moderately high speed.
2. Start the engine of vehicle **A**.
3. Run both vehicles for a minimum of three minutes before disconnecting the cables.

CAUTION

- ⚠ Do not switch on the headlamps when disconnecting the cables. The peak voltage could blow the bulbs.

Disconnect the cables in the reverse order.

Vehicle battery

BATTERY CONNECTION POINTS

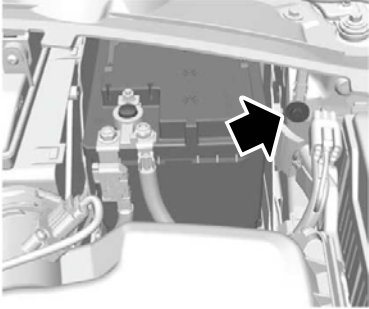

E114494

CAUTION

 **Do not connect to the negative (-) terminal of the flat battery.**

Wheels and tyres

GENERAL INFORMATION

CAUTIONS

 Use only approved wheel and tyre sizes. Using other sizes could damage the vehicle and will make the National Type Approval invalid.

 If you change the diameter of the tyres from that fitted at the factory, the speedometer may not display the correct speed. Take the vehicle to your dealer to have the engine management system reprogrammed.

A decal with tyre pressure data is located in the driver's door opening at the B-pillar.

Check and set the tyre pressure at the ambient temperature in which you are intending to drive the vehicle and when the tyres are cold.

CHANGING A ROAD WHEEL

Locking wheel nuts

You can obtain a replacement locking wheel nut key and replacement locking wheel nuts from your dealer using the reference number certificate.

Vehicles with a temporary spare wheel

WARNINGS

 If the spare wheel differs from the other fitted wheels, these rules must be followed:

 Do not exceed 80 km/h (50 mph).

 Drive the shortest possible distances.

 Do not fit more than one spare wheel on your vehicle at any one time.

WARNINGS

 Do not use snow chains on this type of wheel.

 Do not drive through an automatic car wash.

 Do not carry out any tyre repairs on a temporary spare wheel.

CAUTION

 The ground clearance of your vehicle will be reduced. Take care when parking next to a curb.

Note: *Your vehicle may exhibit some unusual driving characteristics.*

Vehicle jack

WARNINGS

 The vehicle jack supplied with your vehicle should only be used when changing a wheel in emergency situations.

 Before using the vehicle jack, check that it is not damaged or deformed and that the thread is lubricated and free from foreign matter.

 Never place anything between the jack and the ground, or the jack and the vehicle.

Note: *Vehicles with a tyre repair kit are not equipped with a vehicle jack or a wheel brace.*

It is recommended to use a workshop type hydraulic jack for changing between summer and winter tyres.

Note: *Use a jack with a minimum lifting capacity of 1.5 tonnes and a lifting plate with a minimum diameter of 80 millimetres (3.1 inches).*

Wheels and tyres

Vehicles without tyre repair kit

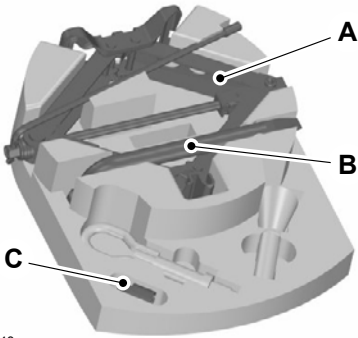

E86843

- A Jack
- B Wheel brace
- C Space for locking wheel nut key

Your vehicle jack and wheel brace are located in the spare wheel well.

Jacking and lifting points

CAUTION

 Use only the specified jacking points. If you use other positions, you may damage the body, steering, suspension, engine, braking system or the fuel lines.

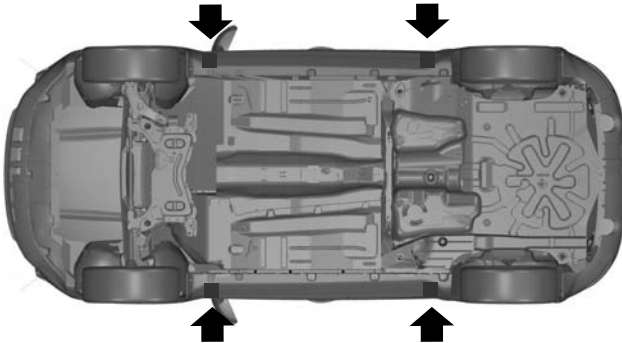

E92658

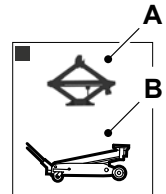

- A Emergency use only
- B Maintenance

Wheels and tyres

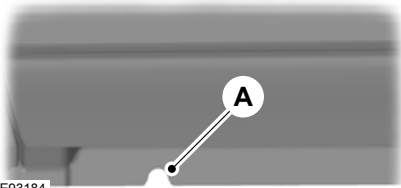

E93184

Indentations in the sills **A** show the location of the jacking points.

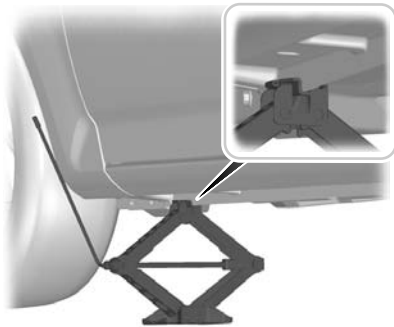

E92932



E93020

Vehicles with side skirts

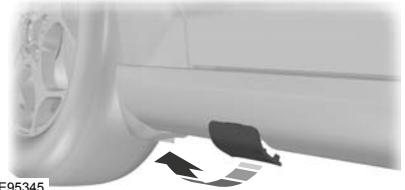

E95345

Assembling the wheel brace

Type one

WARNING



When returning the wheel brace extension to its original position, take care not to get your fingers caught.

Note: Make sure that the wheel brace is fully extended.



E122546

Extend the wheel brace.

Type two

CAUTION



The screw-in towing eye has a **left-hand thread**. Turn it anti-clockwise to install it. Make sure that the towing eye is fully tightened.

Wheels and tyres

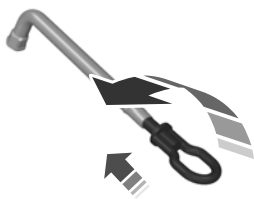

E122502

Insert the screw-in towing eye into the wheel brace.

Removing the wheel trim

Type one

Insert the flat end of the wheel brace between the rim and the trim and carefully remove the trim.

Type two

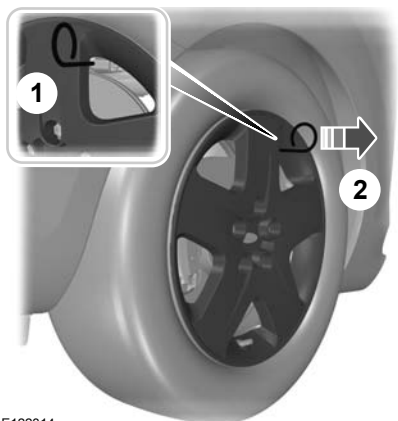











E122314

1. Insert the wheel trim remover.
2. Remove the wheel trim.

Note: Make sure that you pull the wheel trim remover at right angles to the trim.

Removing a road wheel

WARNINGS

-  Park your vehicle in such a position that neither the traffic nor you are hindered or endangered.
-  Set up a warning triangle.
-  Make sure that the vehicle is on firm, level ground with the wheels pointing straight ahead.
-  Switch off the ignition and apply the parking brake.
-  If your vehicle has a manual transmission, select first or reverse gear. If it has an automatic transmission, select park.
-  Have the passengers leave the vehicle.
-  Secure the diagonally opposite wheel with an appropriate block or wheel chock.
-  Make sure that the arrows on directional tyres point in the direction of rotation when the vehicle is moving forwards. If you have to fit a spare wheel with the arrows pointing in the opposite direction, have the tyre refitted in the correct direction by a properly trained technician.
-  Do not work underneath the vehicle when it is supported only by a jack.
-  Make sure that the jack is vertical to the jacking point and the base is flat on the ground.

CAUTION

-  Do not lay alloy wheels face down on the ground, this will damage the paint.

Wheels and tyres

Note: The spare wheel is located under the floor cover in the luggage compartment.



E71948

1. Install the locking wheel nut key.
2. Slacken the wheel nuts.
3. Jack up the vehicle until the tyre is clear of the ground.
4. Remove the wheel nuts and the wheel.

Installing a road wheel

WARNINGS

 Use only approved wheel and tyre sizes. Using other sizes could damage the vehicle and will make the National Type Approval invalid. See **Technical specifications** (page 231).

 Do not fit run flat tyres on vehicles that were not originally fitted with them. Please contact your dealer for more details regarding compatibility.

CAUTION

 Do not install alloy wheels using wheel nuts designed for use with steel wheels.

Note: Make sure the wheel and hub contact surfaces are free from foreign matter.

Note: Make sure that the cones on the wheel nuts are against the wheel.

1. Install the wheel.
2. Install the wheel nuts finger tight.
3. Install the locking wheel nut key.

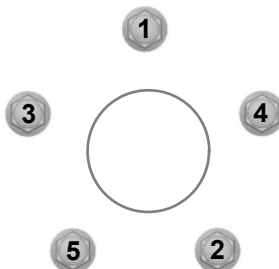

E75442

4. Partially tighten the wheel nuts in the sequence shown.
5. Lower the vehicle and remove the jack.
6. Fully tighten the wheel nuts in the sequence shown. See **Technical specifications** (page 231).
7. Install the hub cap or cover using the ball of your hand.

WARNING

 Have the wheel nuts checked for tightness and the tyre pressure checked as soon as possible.

Wheels and tyres

Note: If the spare wheel is different in size or construction to the road wheels, have this replaced as soon as possible.

RUN FLAT TYRES

Principle of operation

Standard tyre

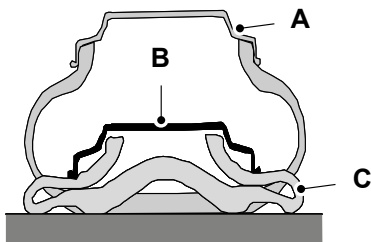

E75207

- A Wheel rim position with correct tyre pressure
- B Wheel rim position with insufficient tyre pressure
- C Tyre

Run flat tyre

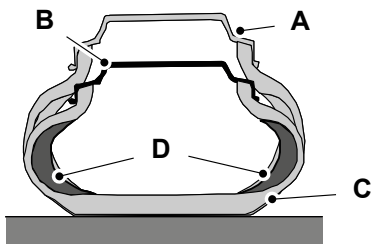

E87667

- A Wheel rim position with correct tyre pressure
- B Wheel rim position with insufficient tyre pressure

- C Tyre
- D Reinforced sidewall

When a standard tyre experiences a drastic loss of inflation pressure, the rim of the wheel brings the full weight of the vehicle to bear on the collapsed sidewalls. You can barely manoeuvre the vehicle and the tyre is destroyed.

Run flat tyres have sturdy, reinforced sidewalls that support the rim should the tyre suffer a loss of inflation pressure.

What to do if a run flat tyre has a puncture

Due to the run-flat properties of these tyres, you may not notice any tyre defect. Your vehicle is equipped with a tyre pressure monitoring system that alerts you to any drop in tyre pressure. See **Technical specifications** (page 231).

In the event of a tyre defect:

- immediately slow down to a maximum speed of 80 km/h (50 mph)
- avoid sudden or erratic braking and steering manoeuvres and be especially careful negotiating bends
- do not drive more than 80 kilometres (50 miles) after the defect is detected
- have the defective tyre replaced as soon as possible.

Replacing run flat tyres

WARNINGS



Make sure that the workshop is aware that your vehicle is equipped with special run flat tyres.





Never repair or reuse run flat tyres that are damaged or have been driven on run flat.

Wheels and tyres

WARNINGS

If a run flat tyre has to be replaced, have the respective wheel rim inspected for any damage.

 Do not fit a mixture of run flat and standard tyres. In isolated cases, a standard tyre can be temporarily mounted on a vehicle otherwise equipped with run flat tyres. It must be pointed out to the driver that the standard tyre has no runflat properties.

 Do not fit run flat tyres on vehicles that were not originally fitted with them. Please contact your dealer for more details regarding compatibility.

Run flat tyres may be sold and mounted only by specially trained and certified tyre dealers.

TYRE REPAIR KIT

Your vehicle may not have a spare tyre. In this case it will have an emergency tyre repair kit that can be used to repair **one** flat tyre.

The tyre repair kit is located in the spare wheel well.

General information

WARNINGS

 Depending on the type and extent of tyre damage, some tyres can only be partially sealed or not sealed at all. Loss of tyre pressure can affect vehicle handling, leading to loss of vehicle control.

 Do not use the tyre repair kit if the tyre has already been damaged as a result of being driven under inflated.

 Do not use the tyre repair kit on run flat tyres.

WARNINGS

 Do not try to seal damage other than that located within the visible tread of the tyre.

 Do not try to seal damage to the tyre's sidewall.

The tyre repair kit seals most tyre punctures [with a diameter of up to six millimetres (1/4 inch)] to temporarily restore mobility.

Observe the following rules when using the kit:

- **Drive with caution and avoid making sudden steering or driving manoeuvres**, especially if the vehicle is heavily loaded or you are towing a trailer.
- The kit will provide you with an emergency temporary repair, enabling you to continue your journey to the next vehicle or tyre dealer, or to drive a maximum distance of 200 kilometres (125 miles).
- Do not exceed a **maximum speed of 80 km/h (50 mph)**.
- Keep the kit out of the reach of children.
- Only use the kit when the ambient temperature is between -30°C (-22°F) and $+70^{\circ}\text{C}$ ($+158^{\circ}\text{F}$).

Using the tyre repair kit

WARNINGS

 Compressed air can act as an explosive or propellant.

 Never leave the tyre repair kit unattended while in use.

Wheels and tyres

CAUTION



-  Do not keep the compressor operating for more than 10 minutes.

Note: Use the tyre repair kit only for the vehicle with which it was supplied.



- Park your vehicle at the roadside so that you do not obstruct the flow of traffic and so that you are able to use the kit without being in danger.
- Apply the parking brake, even if you have parked on a level road, to make sure that the vehicle will not move.
- Do not attempt to remove foreign objects like nails or screws penetrating the tyre.
- Leave the engine running while the kit is in use, but not if the vehicle is in an enclosed or poorly ventilated area (for example, inside a building). In these circumstances, switch the compressor on with the engine turned off.
- Replace the sealant bottle with a new one before the expiry date (see top of bottle) is reached.
- Inform all other users of the vehicle that the tyre has been temporarily sealed with the tyre repair kit and make them aware of the special driving conditions to be observed.

Inflating the tyre

WARNINGS

-  Check the sidewall of the tyre prior to inflation. If there are any cracks, bumps or similar damage, do not attempt to inflate the tyre.
-  Do not stand directly beside the tyre while the compressor is pumping.

WARNINGS

-  Watch the sidewall of the tyre. If any cracks, bumps or similar damage appear, turn off the compressor and let the air out by means of the pressure relief valve **B**. Do not continue driving with this tyre.
-  The sealant contains natural rubber latex. Avoid contact with skin and clothing. If this happens, rinse the affected areas immediately with plenty of water and contact your doctor.
-  If the tyre inflation pressure does not reach 1.8 bar (26 psi) within seven minutes, the tyre may have suffered excessive damage, making a temporary repair impossible. In this case, do not continue driving with this tyre.

CAUTION

-  Screwing the bottle onto the bottle holder will pierce the seal of the bottle. Do not unscrew the bottle from the holder as the sealant will escape.

Wheels and tyres

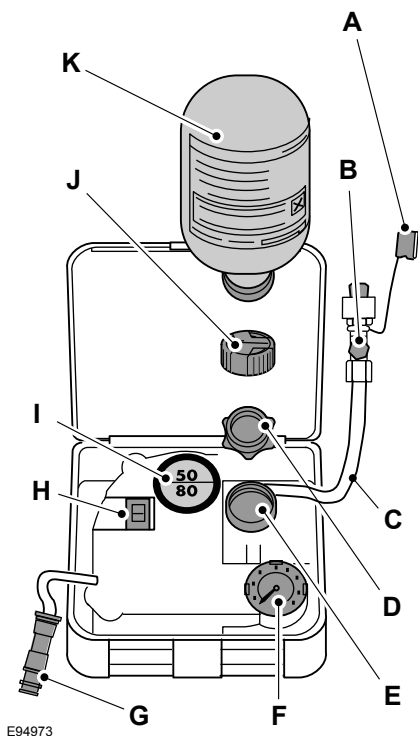

E94973

- A Protective cap
- B Pressure relief valve
- C Hose
- D Orange cap
- E Bottle holder
- F Pressure gauge
- G Power plug with cable
- H Compressor switch
- I Label

- J Bottle lid
- K Sealant bottle

1. Open the lid of the tyre repair kit.
2. Peel off the label **I** showing the maximum permissible speed of 80 km/h (50 mph) from the casing and attach it to the instrument panel in the driver's field of view. Make sure the label does not obscure anything important.
3. Take the hose **C** and the power plug with cable **G** out of the kit.
4. Unscrew the orange cap **D** and the bottle lid **J**.
5. Screw the sealant bottle **K** clockwise into the bottle holder **E** fully tight.
6. Remove the valve cap from the damaged tyre.
7. Detach the protective cap **A** from the hose **C** and screw the hose **C** firmly onto the valve of the damaged tyre.
8. Make sure that the compressor switch **H** is in position **O**.
9. Insert the power plug **G** into the cigar lighter socket or auxiliary power socket. See **Cigar lighter** (page 120). See **Auxiliary power sockets** (page 121).
10. Start the engine.
11. Move the compressor switch **H** to position **1**.
12. Inflate the tyre for no longer than seven minutes to an inflation pressure of minimum 1.8 bar (26 psi) and a maximum of 3.5 bar (51 psi). Move the compressor switch **H** to position **O** and check the current tyre pressure with pressure gauge **F**.
13. Remove the power plug **G** from the cigar lighter socket or auxiliary power socket.

Wheels and tyres

14. Quickly unscrew the hose **C** from the tyre valve and replace the protective cap **A**. Fasten the valve cap again.
15. Leave the sealant bottle **K** in the bottle holder **E**.
16. Make sure the kit, the bottle lid and the orange cap are stored safely, but still easily accessible in the vehicle. The kit will be required again when you check the tyre pressure.
17. Immediately drive approximately three kilometres (two miles) so that the sealant can seal the damaged area.

Note: *When pumping in the sealant through the tyre valve, the pressure may rise up to 6 bar (87 psi) but will drop again after about 30 seconds.*

WARNING



If you experience heavy vibrations, unsteady steering behaviour or noises while driving, reduce your speed and drive with caution to a place where it is safe for you to stop the vehicle. Recheck the tyre and its pressure. If the tyre pressure is less than 1.3 bar (19 psi) or if there are any cracks, bumps or similar damage visible, do not continue driving with this tyre.

Checking the tyre pressure

1. Stop the vehicle after driving approximately three kilometres (two miles). Check, and where necessary, adjust the pressure of the damaged tyre.
2. Attach the kit and read the tyre pressure from the pressure gauge **F**.
3. If the pressure of the sealant-filled tyre is 1.3 bar (19 psi) or more, adjust it to the specified pressure. See **Technical specifications** (page 231).

4. Follow the inflation procedure once again to top up the tyre.
5. Check the tyre pressure again from the pressure gauge **F**. If the tyre pressure is too high, deflate the tyre to the specified pressure using the pressure relief valve **B**.
6. Once you have inflated the tyre to its correct tyre pressure, move the compressor switch **H** to position **O**, remove the power plug **G** from the socket, unscrew the hose **C**, fasten the valve cap and replace the protective cap **A**.
7. Leave the sealant bottle **K** in the bottle holder **E** and store the kit away safely in its original location.
8. Drive to the nearest tyre specialist to get the damaged tyre replaced. Before the tyre is removed from the rim, inform your tyre dealer that the tyre contains sealant. Renew the kit as soon as possible after it has been used once.

Note: *Remember that emergency roadside tyre repair kits only provide temporary mobility. Regulations concerning tyre repair after usage of tyre repair kit may differ from country to country. You should consult a tyre specialist for advice.*

WARNING



Before driving, make sure the tyre is adjusted to the recommended inflation pressure. See **Technical specifications** (page 231). Monitor the tyre pressure until the sealed tyre is replaced.

Empty sealant bottles can be disposed of together with normal household waste. Return remains of sealant to your dealer or dispose of it in compliance with local waste disposal regulations.

Wheels and tyres

TYRE CARE



E70415

To make sure the front and rear tyres of your vehicle wear evenly and last longer, we recommend that you swap the tyres from front to rear and vice versa at regular intervals of between 5 000 and 10 000 km (3 000 and 6 000 miles).

CAUTION

- ⚠ Do not scrub the sidewalls of the tyres when you are parking.

If you have to mount a kerb, do so slowly and approach it with the wheels at right-angles to the kerb.

Examine the tyres regularly for cuts, foreign objects and uneven wear of the tread. Uneven wear could mean that the wheel alignment is outside specification.

Check the tyre pressures (including the spare) when cold, every two weeks.

USING WINTER TYRES

CAUTION

- ⚠ Make sure that you use the correct wheel nuts for the type of wheel the winter tyres are fitted to.

If winter tyres are used, make sure that the tyre pressures are correct. See **Technical specifications** (page 231).

USING SNOW CHAINS

WARNINGS

- ⚠ Do not exceed 50 km/h (30 mph).
- ⚠ Do not use snow chains on snow-free roads.
- ⚠ Do not fit snow chains to 235/45 R 17, 235/40 R 18 or T125/90 R 16 tyres.

CAUTION

- ⚠ If your vehicle is fitted with wheel trims, remove them before fitting snow chains.

Note: *The ABS will continue to operate normally.*

Only use small link snow chains.

Only use snow chains on the front wheels.



TYRE PRESSURE MONITORING SYSTEM

WARNINGS

- ⚠ The system does not relieve you of your responsibility to regularly check the tyre pressures.
 - ⚠ The system will only provide a low tyre pressure warning. It will not inflate the tyres.
 - ⚠ The system may take longer to detect low pressure in the tyres if you have fitted snow chains.
 - ⚠ Do not drive on significantly under-inflated tyres. This may cause the tyres to overheat and fail.
- Under-inflation reduces fuel efficiency, tyre tread life and may also affect your ability to drive the vehicle safely.

Wheels and tyres

CAUTIONS

-  Do not bend or damage the valves when you are inflating the tyres.
-  Have tyres installed by properly trained technicians.

The system monitors the pressure in the tyres using sensors located on the wheels and a receiver located in your vehicle. When the system detects low pressure in the tyres, a warning message is displayed in the information display. See **Information messages** (page 91).

If a low pressure warning message is displayed in the information display, check the tyre pressures as soon as possible and inflate them to the recommended pressure. See **Technical specifications** (page 231). If this happens frequently, have the cause determined and rectified as soon as possible.

Checking the tyre pressures

Note: *If the tyre pressures are greater than or equal to 3.3 bar (48 lbf/in²), you will see the + symbol below the pressure value. The system only measures pressure up to 3.3 bar (48 lbf/in²). The + symbol indicates that the tyre pressures may be higher.*

Note: *Type 3 instrument clusters have a slightly different menu structure. Select **Settings** first to access **Information**.*

1. Press the right arrow button on the steering wheel to enter the main menu.
2. Highlight **Information** with the up and down buttons and press the right arrow button.

3. Highlight **Tyre Pressures** with the up and down buttons and press the right arrow button.
4. Highlight the desired setting and press the **OK** button to confirm the setting.
5. Press the left arrow button to exit the menu. Hold the left arrow button pressed to return to the trip computer display.

Setting the vehicle load

Note: *Type 3 instrument clusters have a slightly different menu structure. Select **Settings** first to access **Setup**.*

Correct tyre pressure settings depend on vehicle load. See **Technical specifications** (page 231). The system can only detect low pressure if you have entered the current vehicle load.

1. Press the right arrow button on the steering wheel to enter the main menu.
2. Highlight **Setup** with the up and down buttons and press the right arrow button.
3. Highlight **Tyre Pressures** with the up and down buttons and press the right arrow button.
4. Highlight the desired setting and press the **OK** button to confirm the setting.
5. Press the left arrow button to exit the menu. Hold the left arrow button pressed to return to the trip computer display.

Wheels and tyres

TECHNICAL SPECIFICATIONS

Wheel nut torque

Wheel type	Nm (lb-ft)
All	140 (103)

Tyre pressures (cold tyres)

Up to 80 km/h (50 mph)

Tyre pressures

Variant	Tyre size	Normal load		Full load	
		Front	Rear	Front	Rear
		bar (lbf/in ²)	bar (lbf/in ²)	bar (lbf/in ²)	bar (lbf/in ²)
All	T125/90 R 16	4.2 (61)	4.2 (61)	4.2 (61)	4.2 (61)

Up to 160 km/h (100 mph)

Tyre pressures

Variant	Tyre size	Normal load		Full load	
		Front	Rear	Front	Rear
		bar (lbf/in ²)	bar (lbf/in ²)	bar (lbf/in ²)	bar (lbf/in ²)
1.6L Duratec-Ti-VCT	205/55 R 16	2.2 (32)	2.2 (32)	2.5 (36)	2.9 (42)
2.0L Duratec-HE	215/55 R 16	2.2 (32)	2.2 (32)	2.5 (36)	2.9 (42)
2.0L Duratec-HE	235/45 R 17	2.2 (32)	2.2 (32)	2.5 (36)	2.9 (42)
2.0L Duratec-HE	235/40 R 18	2.2 (32)	2.2 (32)	2.5 (36)	2.9 (42)
2.3L Duratec-HE	215/55 R 16	2.2 (32)	2.2 (32)	2.5 (36)	2.9 (42)
2.3L Duratec-HE	235/45 R 17	2.2 (32)	2.2 (32)	2.5 (36)	2.9 (42)
2.3L Duratec-HE	235/40 R 18	2.2 (32)	2.2 (32)	2.5 (36)	2.9 (42)
2.5L Duratec-ST and 2.0L EcoBoost SCTi	215/55 R 16	2.4 (35)	2.2 (32)	2.5 (36)	2.9 (42)

Wheels and tyres

Variant	Tyre size	Normal load		Full load	
		Front	Rear	Front	Rear
		bar (lbf/in ²)	bar (lbf/in ²)	bar (lbf/in ²)	bar (lbf/in ²)
2.5L Duratec-ST and 2.0L EcoBoost SCTi	235/45 R 17	2.4 (35)	2.2 (32)	2.5 (36)	2.9 (42)
2.5L Duratec-ST and 2.0L EcoBoost SCTi	235/40 R 18	2.4 (35)	2.2 (32)	2.6 (38)	3.0 (44)
1.8L Duratorq-TDCi	205/55 R 16	2.4 (35)	2.2 (32)	2.5 (36)	2.9 (42)
1.8L Duratorq-TDCi	215/55 R 16	2.4 (35)	2.2 (32)	2.5 (36)	2.9 (42)
1.8L Duratorq-TDCi	235/45 R 17	2.4 (35)	2.2 (32)	2.5 (36)	2.9 (42)
1.8L Duratorq-TDCi	235/40 R 18	2.4 (35)	2.2 (32)	2.6 (38)	3.0 (44)
2.0L Duratorq-TDCi	215/55 R 16	2.4 (35)	2.2 (32)	2.5 (36)	2.9 (42)
2.0L Duratorq-TDCi	235/45 R 17	2.4 (35)	2.2 (32)	2.5 (36)	2.9 (42)
2.0L Duratorq-TDCi	235/40 R 18	2.4 (35)	2.2 (32)	2.6 (38)	3.0 (44)
2.2L Duratorq-TDCi	215/55 R 16	2.4 (35)	2.2 (32)	2.5 (36)	2.9 (42)
2.2L Duratorq-TDCi	235/45 R 17	2.4 (35)	2.2 (32)	2.5 (36)	2.9 (42)
2.2L Duratorq-TDCi	235/40 R 18	2.4 (35)	2.2 (32)	2.6 (38)	3.0 (44)

Continuous speed in excess of 160 km/h (100 mph)

Tyre pressures

Variant	Tyre size	Normal load		Full load	
		Front	Rear	Front	Rear
		bar (lbf/in ²)	bar (lbf/in ²)	bar (lbf/in ²)	bar (lbf/in ²)
1.6L Duratec-Ti-VCT	205/55 R 16	2.2 (32)	2.2 (32)	2.5 (36)	2.9 (42)
2.0L Duratec-HE	215/55 R 16	2.2 (32)	2.2 (32)	2.6 (38)	3.0 (44)
2.0L Duratec-HE	235/45 R 17	2.2 (32)	2.2 (32)	2.6 (38)	3.0 (44)
2.0L Duratec-HE	235/40 R 18	2.2 (32)	2.2 (32)	2.6 (38)	3.0 (44)

Wheels and tyres

Variant	Tyre size	Normal load		Full load	
		Front	Rear	Front	Rear
		bar (lbf/in ²)	bar (lbf/in ²)	bar (lbf/in ²)	bar (lbf/in ²)
2.0L EcoBoost SCTi	215/55 R 16	2.5 (36)	2.3 (33)	2.8 (41)	3.2 (46)
2.0L EcoBoost SCTi	235/45 R 17	2.5 (36)	2.3 (33)	2.8 (41)	3.2 (46)
2.0L EcoBoost SCTi	235/40 R 18	2.5 (36)	2.3 (33)	2.8 (41)	3.2 (46)
2.3L Duratec-HE	215/55 R 16	2.4 (35)	2.2 (32)	2.6 (38)	3.0 (44)
2.3L Duratec-HE	235/45 R 17	2.4 (35)	2.2 (32)	2.6 (38)	3.0 (44)
2.3L Duratec-HE	235/40 R 18	2.4 (35)	2.2 (32)	2.6 (38)	3.0 (44)
2.5L Duratec-ST	215/55 R 16	2.5 (36)	2.3 (33)	2.8 (41)	3.3 (48)
2.5L Duratec-ST	235/45 R 17	2.5 (36)	2.3 (33)	2.8 (41)	3.3 (48)
2.5L Duratec-ST	235/40 R 18	2.5 (36)	2.3 (33)	2.8 (41)	3.3 (48)
1.8L Duratorq-TDCi	205/55 R 16	2.4 (35)	2.2 (32)	2.6 (38)	3.0 (44)
1.8L Duratorq-TDCi	215/55 R 16	2.4 (35)	2.2 (32)	2.6 (38)	3.0 (44)
1.8L Duratorq-TDCi	235/45 R 17	2.4 (35)	2.2 (32)	2.6 (38)	3.0 (44)
1.8L Duratorq-TDCi	235/40 R 18	2.4 (35)	2.2 (32)	2.6 (38)	3.0 (44)
2.0L Duratorq-TDCi	215/55 R 16	2.5 (36)	2.3 (33)	2.8 (41)	3.1 (45)
2.0L Duratorq-TDCi	235/45 R 17	2.5 (36)	2.3 (33)	2.8 (41)	3.1 (45)
2.0L Duratorq-TDCi	235/40 R 18	2.5 (36)	2.3 (33)	2.8 (41)	3.1 (45)
2.2L Duratorq-TDCi	215/55 R 16	2.5 (36)	2.3 (33)	2.8 (41)	3.1 (45)
2.2L Duratorq-TDCi	235/45 R 17	2.5 (36)	2.3 (33)	2.8 (41)	3.1 (45)
2.2L Duratorq-TDCi	235/40 R 18	2.5 (36)	2.3 (33)	2.8 (41)	3.1 (45)

Vehicle identification

VEHICLE IDENTIFICATION PLATE

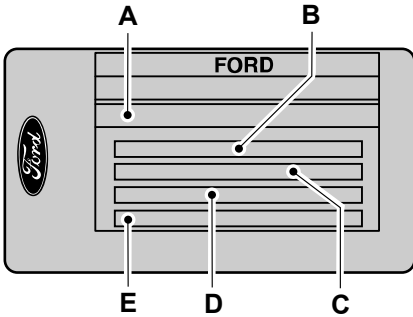

E85610

- A Vehicle identification number
- B Gross vehicle weight
- C Gross train weight
- D Maximum front axle weight
- E Maximum rear axle weight

The vehicle identification number and maximum weights are shown on a plate located on the lock side of the passenger door aperture at the bottom.

VEHICLE IDENTIFICATION NUMBER (VIN)

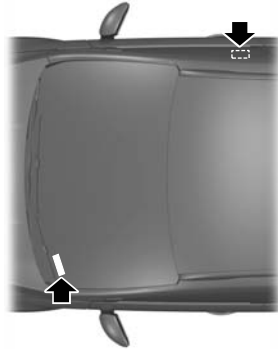

E87496

The vehicle identification number is stamped into the floor panel on the right-hand side, beside the front seat. It is also shown on the left-hand side of the instrument panel.

Technical specifications

TECHNICAL SPECIFICATIONS

Vehicle dimensions

4-door

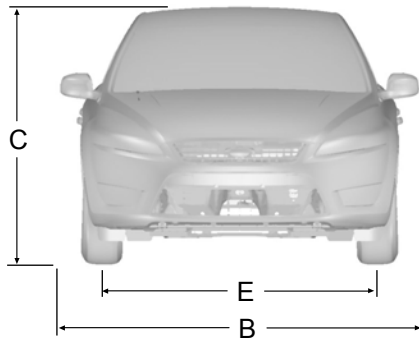
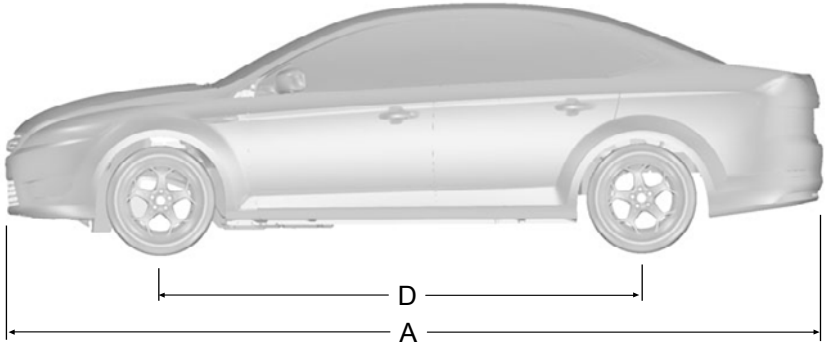

E87088

Item	Dimension description	Dimension in mm (inches)
A	Maximum length	4 844 (190.7)
B	Overall width including exterior mirrors	2 078 (81.8)
C	Overall height at EC kerb weight	1 453 - 1 500 (57.2 - 59.1)

Technical specifications

Item	Dimension description	Dimension in mm (inches)
D	Wheelbase	2 850 (112.2)
E	Front track	1 579 - 1 589 (62.2 - 62.6)
E	Rear track	1 595 - 1 605 (62.8 - 63.2)

5-door

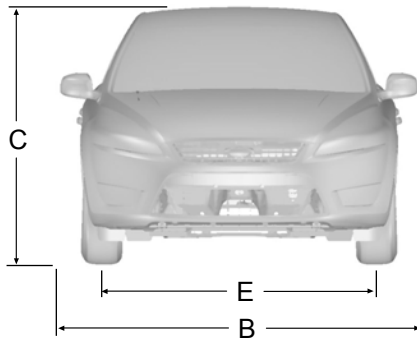
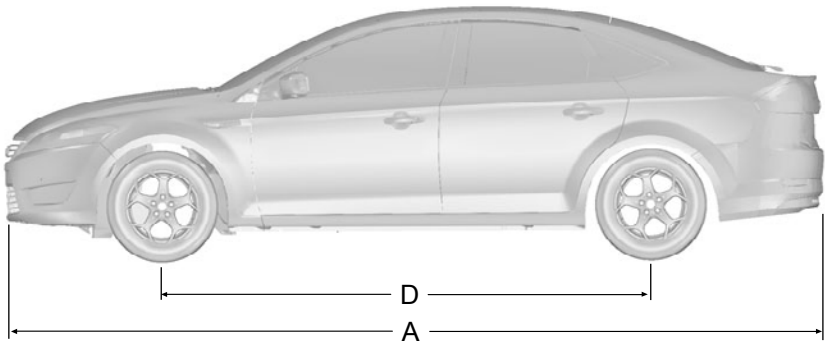

E87089

Technical specifications

Item	Dimension description	Dimension in mm (inches)
A	Maximum length	4 778 - 4 802 (188.1 - 189.1)
B	Overall width including exterior mirrors	2 078 (81.8)
C	Overall height at EC kerb weight	1 453 - 1 500 (57.2 - 59.1)
D	Wheelbase	2 850 (112.2)
E	Front track	1 579 - 1 589 (62.2 - 62.6)
E	Rear track	1 595 - 1 605 (62.8 - 63.2)

Technical specifications

Estate

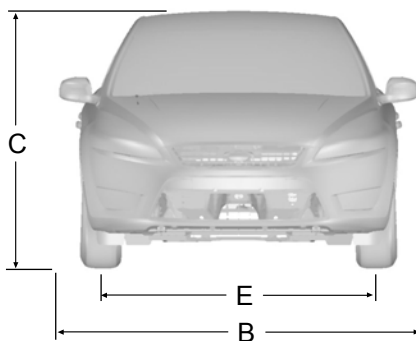
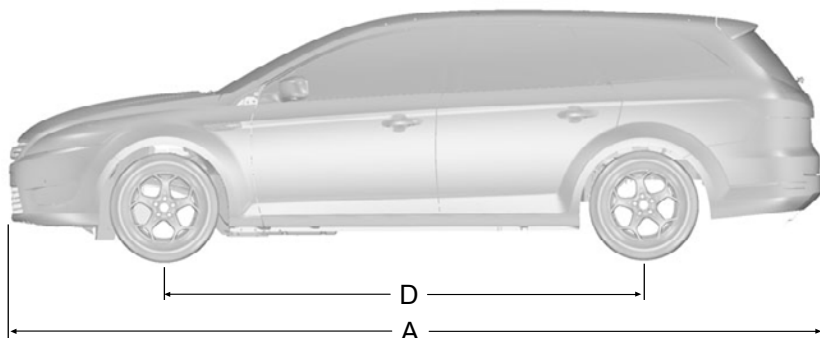

E87090

Item	Dimension description	Dimension in mm (inches)
A	Maximum length	4 830 - 4 856 (190.2 - 191.2)
B	Overall width including exterior mirrors	2 078 (81.8)
C	Overall height at EC kerb weight without roof bars	1 466 - 1 512 (57.7 - 59.5)
C	Overall height at EC kerb weight including roof bars	1 502 - 1 548 (59.1 - 61)
D	Wheelbase	2 850 (112.2)

Technical specifications

Item	Dimension description	Dimension in mm (inches)
E	Front track	1 579 - 1 589 (62.2 - 62.6)
E	Rear track	1 595 - 1 605 (62.8 - 63.2)

Towing equipment dimensions

4-door

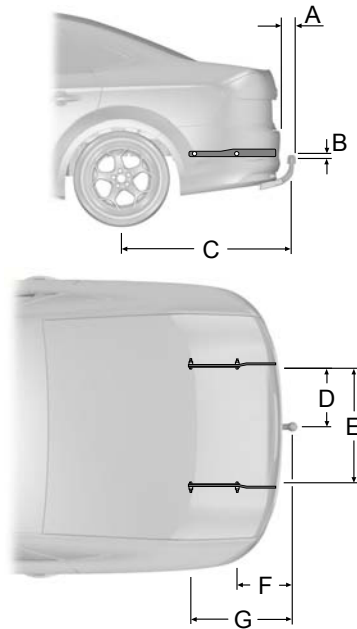

E87091

Item	Dimension description	Dimension in mm (inches)
A	Bumper – end of tow ball	102 (4)
B	Attachment point – centre of tow ball	1 (0.04)

Technical specifications

Item	Dimension description	Dimension in mm (inches)
C	Wheel centre – centre of tow ball	1 150 (45.3)
D	Centre of tow ball – side member	438 (17.2)
E	Inner side of side member	876 (34.5)
F	Centre of tow ball – centre 1. attachment point	434 (17.1)
G	Centre of tow ball – centre 2. attachment point	707 (27.8)

5-door

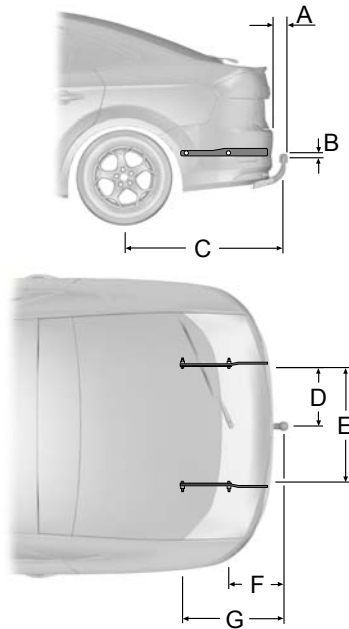

E87092

Technical specifications

Item	Dimension description	Dimension in mm (inches)
A	Bumper – end of tow ball	100 (3.9)
A	Bumper – end of tow ball (with sport bumper)	90 (3.5)
B	Attachment point – centre of tow ball	1 (0.04)
C	Wheel centre – centre of tow ball	1 082 (42.6)
D	Centre of tow ball – side member	438 (17.2)
E	Inner side of side member	876 (34.5)
F	Centre of tow ball – centre 1. attachment point	364 (14.3)
G	Centre of tow ball – centre 2. attachment point	637 (25.1)

Estate

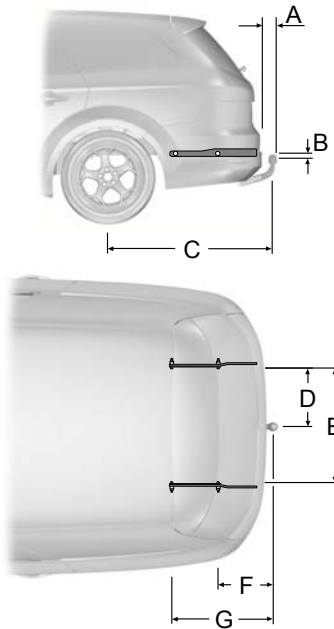

E87093

Technical specifications

Item	Dimension description	Dimension in mm (inches)
A	Bumper – end of tow ball	100 - 110 (3.9 - 4.3)
B	Attachment point – centre of tow ball	1 (0.04)
C	Wheel centre – centre of tow ball	1 134 - 1 144 (44.7 - 45)
D	Centre of tow ball – side member	438 (17.2)
E	Inner side of side member	876 (34.5)
F	Centre of tow ball – centre 1. attachment point	419 - 429 (16.5 - 16.9)
G	Centre of tow ball – centre 2. attachment point	692 - 702 (27.2 - 27.6)

Telephone

GENERAL INFORMATION

CAUTION

 Using the system with the engine off will drain the battery.

This section describes the functions and features of the Bluetooth mobile phone hands free system.

The Bluetooth mobile phone part of the system provides interaction with the audio or navigation system and your mobile phone. It allows you to use the audio or navigation system to make and receive calls without having to use your mobile phone.

Compatibility of phones

CAUTION

 As no common agreement exists, mobile phone manufacturers are able to implement a variety of profiles in their Bluetooth devices. Because of this, an incompatibility can occur between the phone and hands-free system, which in some cases may significantly degrade the system performance. To avoid this situation, only recommended phones should be used.

Please visit the website www.ford-mobile-connectivity.com for full details.

TELEPHONE SETUP

Phonebook

After start up access to the phonebook list can be delayed for several minutes, depending upon the size.

Phonebook categories

Depending on your phonebook entry, different categories can be displayed in the audio unit.

For example:

M	Mobile
O	Office
H	Home
F	Fax

Note: *Entries may be displayed without a category attachment.*

The category can also be indicated as an icon:



Making a phone an active phone

When using the system for the first time, no phone is connected to the system.

Bluetooth phone

After bonding a Bluetooth phone to the system, this becomes the active phone. For further information refer to the phone menu.

Telephone

Select the phone from the active phone menu.

Turning the ignition and radio or navigation unit back on again, the last active phone is picked up by the system.

Note: *In some cases the Bluetooth connection must also be confirmed on the phone.*

Bond another Bluetooth phone

Bond a new Bluetooth phone as described in the requirements for a Bluetooth connection.

Phones stored in the system are accessible by using the phone list on the audio unit.

Note: *A maximum of six devices may be bonded. If six Bluetooth devices have already been bonded, one of these has to be debonded in order to bond a new device.*

BLUETOOTH SETUP

Before you can use your telephone with your vehicle it must be bonded to the vehicle telephone system.

Handling of phones

Up to six Bluetooth devices can be bonded to the vehicle system.

Note: *If there is an ongoing call when the phone in use is selected as the new active phone, the call is transferred to the vehicle audio system.*

Note: *Even if connected to the car system, your phone can still be used in the usual way.*

Requirements for Bluetooth connection

The following are required before a Bluetooth phone connection can be made.

1. The Bluetooth feature must be activated on the phone and on the audio unit. Make sure the Bluetooth menu option in the audio unit is set to **ON**. For information on phone settings, refer to your phone user guide.
2. The private mode must not be activated on the Bluetooth phone.
3. Search for audio device.
4. Select **Ford Audio**.
5. Enter the code number shown on the vehicle display using the phone keypad. If no code number is shown on the display, enter the Bluetooth PIN number 0000 using the phone keypad. Now enter the Bluetooth PIN number shown on the vehicle display.

Note: *A phone call will be disconnected if the audio unit is switched off. If the ignition key is turned to the off position the phone call will remain in progress.*

Telephone

TELEPHONE CONTROLS

Remote control

Voice, accept and reject button

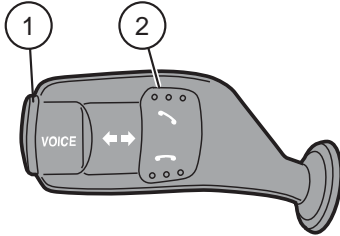

E87662

- 1 Voice button
- 2 Accept and reject button

The VOICE button is used to activate or switch off the Voice control.

On vehicles with an accept and reject button, phone calls can be accepted and rejected by pressing the appropriate button.

Note: Some audio units have the accept and reject buttons on the front bezel. These operate in the same way.

USING THE TELEPHONE - VEHICLES WITHOUT NAVIGATION SYSTEM

This chapter describes the phone functions of the audio unit.

Note: Refer to your audio guide for details of the controls.

An active phone must be present.

Even if connected to the audio unit, your phone can still be used in the usual way.

Note: You can exit the phone menu by pressing any source button **CD**, **AM/FM** or **AUX**.

Making a call

Dialling a number using voice control

Phone numbers can be dialled using voice control. See **Telephone commands** (page 260).

Dialling a number using the address book

You can access your phone address book via Bluetooth. The entries will appear in the unit display.

1. Press the **PHONE** or the call accept button.
2. Press the **MENU** button.
3. Keep pressing the **MENU** button until **PHONEBOOK** appears.
4. Press the seek buttons to select the desired phone number.

Note: Press and hold the seek button to skip to the next letter in the alphabet.

5. Press the **PHONE** or the call accept button to dial the selected phone number.

Dialling a number using the address book - Sony radio

You can access your phone address book via Bluetooth. The entries will appear in the unit display.

1. Press the **PHONE** button.
2. Press the seek button until the phone book is shown.
3. Press the up/down arrow buttons to select the desired phone number.

Note: Press and hold the up/down arrow buttons to skip to the next letter in the alphabet.

Telephone

4. Press the **PHONE** or the call accept button to dial the selected phone number.

Dialling a number using the telephone keypad

If you have an audio unit with a telephone keypad (buttons 0-9, * and #):

1. Press the call accept button. Press the **PHONE** button if you have a Sony radio.
2. Dial the number using the telephone keypad on the audio unit.
3. Press the call accept button.

Note: *If you enter an incorrect digit whilst entering a phone number, press the seek left button to erase the last digit. A long press will erase the complete string of digits.*

*Press and hold **0** to enter a + digit.*

Ending a call

Calls can be ended by pressing the call reject button.

Audio units without a telephone keypad can also end a call by pressing either **PHONE**, **CD**, **AM/FM** or **ON/OFF**, or by pressing the **MODE** button on the remote control

Redialling a number

1. Press the **PHONE** or the call accept button.
2. Press the **MENU** button.
3. Select the **CALL OUT** list or the **CALL IN** list. On some audio units, select the **MISSED**, **INCOMING** or **OUTGOING** calls list.

Note: *If the active phone does not provide a call out list, the last outgoing call number/entry can be redialled.*

4. Press the seek button on the audio unit.

5. Press the **PHONE** or the call accept button to dial the desired phone number.

Redialling a number - Sony radio

1. Press the **PHONE** or the call accept button.
2. Press the seek button until the desired list is displayed.

Note: *If the active phone does not provide a call out list, the last outgoing call number/entry can be redialled.*

3. Press the up/down buttons to select the desired phone number.
4. Press the **PHONE** or the call accept button to dial the phone number.

Redialling the last dialled number - Sony radio

1. Press the call accept button.
2. Press the call accept button a second time to dial the number.

Receiving an incoming call

Accepting an incoming call

Incoming calls can be accepted by pressing either the call accept button, the **PHONE** button or the **MODE** button on the remote control.

Rejecting an incoming call

Incoming calls can be rejected by pressing the call reject button.

Audio units without a telephone keypad can also reject a call by pressing either **PHONE**, **CD**, **AM/FM** or **ON/OFF**.

Receiving a second incoming call

Note: *The second incoming call function must be activated in your phone.*

Telephone

If there is an incoming call whilst there is an ongoing call, a beep will be heard and you will have the option to end the active call and to accept the incoming call.

Accepting a second incoming call

Second incoming calls can be accepted by pressing either the call accept button, the **PHONE** button, or the **MODE** button on the remote control.

Rejecting a second incoming call

Second incoming calls can be rejected by pressing the call reject button. Units without a telephone keypad can also reject a second incoming call by pressing the **CD** button, or the **AM/FM** button.

Muting the microphone

During a call, it is possible to mute the microphone. Whilst muted, confirmation will appear in the display.

Audio units with green call accept button

Press the call accept button. Press the button once again to turn this function off.

Audio units without green call accept button

Press the seek up or down button. Press the button once again to turn this function off.

Changing the active phone

Note: *Phones must be bonded to the system before they can be made active.*

Using the station storage button

Note: *This process is only for audio units without a telephone keypad.*

1. Press the **PHONE** button on the audio unit.

2. Press the preset number required (using the station preset buttons 1 - 6).

Using the audio unit menu

Note: *After bonding a phone to the system, this becomes the active phone.*

1. Press the **PHONE** or call accept button.
2. Press the **MENU** button on the audio unit.
3. Select the **ACTIVE PHONE** option on the audio unit.
4. Scroll through the different stored phones by using the seek buttons to display the bonded phones.
5. Press the **MENU** button to select the phone which is to be the active phone.

Debonding a bonded phone

A bonded phone can be deleted from the system at any time, unless a phone call is in progress.

1. Press the **PHONE** or call accept button.
2. Press the **MENU** button on the audio unit.
3. Select the **DEBOND** option on the audio unit.
4. Scroll through the different phones by using the seek buttons and display the phone to be debonded.
5. Press the **MENU** button to select the phone which is to be debonded.

Debonding a bonded phone - Sony radio

A bonded phone can be deleted from the system at any time, unless a phone call is in progress.

1. Press the **PHONE** button.

Telephone

2. Press the up/down arrow buttons until you reach the **DEBOND** option.
3. Scroll through the different phones by using the seek buttons and display the phone to be debonded.
4. Press the OK button to be debond.

USING THE TELEPHONE - VEHICLES WITH: NAVIGATION SYSTEM

This chapter describes the phone functions of the Navigation System.

Note: Refer to your *Navigation System guide* for details of the controls.

An active phone must be present.

Even if connected to the Navigation System, your phone can still be used in the usual way.

Making a call

Dialling a number

Phone numbers can be dialled using voice control. See **Voice control** (page 250).

Ending a call

Calls can be ended by pressing either the **END** button, the **MODE** button on the remote switch or the **ON/OFF** button on the navigation system.

Redialling a number

1. Press the **PHONE** button on the unit.
2. Select **REDIAL**.

Receiving an incoming call

Accepting an incoming call

Incoming calls can be accepted by pressing either the call accept button, the **MODE** button on the remote control, the **PHONE** button on the unit or by using the **ACCEPT** option in the menu.

Rejecting an incoming call

Incoming calls can be rejected by pressing either the call reject button, the **CD** or **AM/FM** buttons on the unit, or by using the **REJECT** option in the menu.

Receiving a second incoming call

Note: The second incoming call function must be activated in your phone.

If there is an incoming call, whilst there is an ongoing call, a beep will be heard and you will have the option to end the active call and to accept the incoming call.

Accepting a second incoming call

Second incoming calls can be accepted by pressing either the call accept button, the **MODE** button on the remote control, the **PHONE** button on the unit or by using the **ACCEPT** option in the menu.

Note: This will cancel the ongoing call.

Rejecting a second incoming call

Second incoming calls can be rejected by pressing either the call reject button, or one of the following buttons on the unit: **CD, AM/FM**.

Muting the microphone

During a call, it is possible to mute the microphone. Whilst muted, confirmation will appear in the display.

Telephone

DVD navigation units

Press the mute button (symbol of a microphone with a line through it). Press the button once again to turn this function off.

CD navigation units

Press the microphone mute button. Press the button once again to turn this function off.

Changing the active phone

Note: *Phones must be bonded to the system before they can be made active.*

Note: *After bonding a phone to the system, this becomes the active phone.*

1. Press the **PHONE** button on the unit.
2. Using the **BT SETTINGS** option in the menu, select the active phone from the list.

Debonding a bonded phone

A bonded phone can be deleted from the system at any time, unless a phone call is in progress.

1. Press the **PHONE** button on the unit.
2. Select the **BT SETTINGS** option in the menu.
3. Select the **DEBOND** option in the menu.
4. Select the phone from the list.

Voice control

PRINCIPLE OF OPERATION

CAUTION

 Using the system with the engine off will drain the battery.

Voice recognition enables operation of the system without the need to divert your attention from the road ahead in order to change settings, or receive feedback from the system.

Whenever you issue one of the defined commands with the system active, the voice recognition system converts your command into a control signal for the system. Your inputs take the form of dialogues or commands. You are guided through these dialogues by announcements or questions.

Please familiarise yourself with the functions of the system before using voice recognition.

Supported commands

The voice control system allows you to control the following vehicle functions:

- Bluetooth phone
- radio
- CD Player/CD Changer
- external device (USB)
- external device (iPod)
- automatic climate control
- navigation system (DVD units only - refer to separate DVD navigation handbook).

System response

As you work through a voice session the system will prompt you with a beep tone each time the system is ready to proceed.

Do not try to give any commands until the beep tone has been heard. The voice control system will repeat each spoken command back to you.

If you are not sure how to continue say "HELP" for assistance or "CANCEL" if you do not wish to continue.

The "HELP" function provides only a subset of the available voice commands. Detailed explanations of all possible voice commands can be found on the following pages.

Voice commands

All voice commands should be given using a natural speaking voice, as if speaking to a passenger or on the phone. Your voice level should be dependant on the surrounding noise level inside or outside the vehicle but do not shout.

USING VOICE CONTROL

System operation

The order and content of the voice controls are given in the following lists. The tables show the sequence of user voice commands and system responses for each available function.

<> indicates a number or stored name tag to be inserted by the user.

Short cuts

There are a number of voice command short cuts available, which allow you to control some vehicle features without having to follow the complete command menu. These are:

- phone: "MOBILE NAME", "DIAL NUMBER", "DIAL NAME", and "REDIAL"
- CD player/CD changer: "DISC" and "TRACK"

Voice control

- automatic climate control: "TEMPERATURE", "AUTO MODE", "DEFROSTING/DEMISTING ON" and "DEFROSTING/DEMISTING OFF"
- radio: "TUNE NAME"
- external device (USB): "TRACK"
- external device (iPod): "TRACK"
- SD card: "TRACK".

Start communicating with the system

Before you can start talking to the system you first have to press the **VOICE** or **MODE** button for each operation and wait until the system answers with a beep. See (page 250).

Press the button again to cancel the voice session.

Name tag

The name tag functionality can support the phone, audio and navigation features by using the "STORE NAME" function. You can assign name tags to items such as favourite radio stations and personal phone contacts. See **Audio unit commands** (page 251). See **Telephone commands** (page 260). See **Navigation system commands** (page 265).

- Store up to 20 name tags per function.
- The average recording time for each name tag is approximately 2-3 seconds.

AUDIO UNIT COMMANDS

CD Player

You can control playback directly by voice control.

Overview

The overview below shows the available voice commands. The following lists will give further information about the complete command menu in selected examples.

"CD PLAYER"
"HELP"
"PLAY"
"TRACK" [*]
"SHUFFLE ALL"
"SHUFFLE FOLDER" ^{**}
"SHUFFLE OFF"
"REPEAT FOLDER" ^{**}

Voice control

"CD PLAYER"
"REPEAT TRACK"
"REPEAT OFF"

* Can be used as a shortcut.

** Only available if the CD contains audio data files like MP3 or WMA.

Track

You can choose a track on your CD directly.

Steps	User says	System answer
1	"CD PLAYER"	"CD PLAYER"
2	"TRACK"*	"TRACK NUMBER PLEASE"
3	"<a number between 1 and 99>"**	"TRACK <number>"

* Can be used as a shortcut.

** Additionally, numbers can be spoken as up to four single digits (for example "2", "4", "5" for track 245)

Shuffle all

To set random playback.

Steps	User says	System answer
1	"CD PLAYER"	"CD PLAYER"
2	"SHUFFLE ALL"	

CD Changer

Overview

The overview below shows the available voice commands. The following lists will give further information about the complete command menu in selected examples.

Voice control

"CD CHANGER"
"HELP"
"PLAY"
"DISC"*
"TRACK"*
"SHUFFLE ALL"
"SHUFFLE CD"
"SHUFFLE FOLDER"**
"SHUFFLE OFF"
"REPEAT CD"
"REPEAT FOLDER"**
"REPEAT TRACK"
"REPEAT OFF"

* Can be used as a shortcut.

** Only available if the CD contains audio data files like MP3 or WMA.

Disc

If you have a CD changer you can choose the disc number.

Steps	User says	System answer
1	"CD CHANGER"	"CD CHANGER"
2	"DISC"*	"DISC NUMBER PLEASE"
3	"<a number between 1 and 6>"	"DISC <number>"

* Can be used as a shortcut.

Track

You can choose a track on your CD directly.

Voice control

Steps	User says	System answer
1	"CD CHANGER"	"CD CHANGER"
2	"TRACK"*	"TRACK NUMBER PLEASE"
3	"<a number between 1 and 99>"**	"TRACK <number>"

* Can be used as a shortcut.

** Additionally, numbers can be spoken as up to four single digits (for example "2", "4", "5" for track 245)

Shuffle CD

To set random playback within the CD contents.

Steps	User says	System answer
1	"CD CHANGER"	"CD CHANGER"
2	"SHUFFLE CD"	

Radio

The radio voice commands support the functionality of the radio and allow you to tune radio stations by voice control.

Overview

The overview below shows the available voice commands. The following lists will give further information about the complete command menu.

"RADIO"
"HELP"
"AM"
"FM"
"TUNE NAME"*
"DELETE NAME"
"DELETE DIRECTORY"
"PLAY DIRECTORY"
"STORE NAME"

Voice control

"RADIO"
"PLAY"

* Can be used as a shortcut.

Tune frequency

This function allows you to tune your radio by voice commands.

Steps	User says	System answer
1	"RADIO"	"RADIO"
2	"AM"	"AM FREQUENCY PLEASE"
	"FM"	"FM FREQUENCY PLEASE"
3	"<frequency>"*	"TUNE <frequency>"

* The frequency may be entered in a variety of ways. Refer below for representative examples.

FM band: 87.5 - 108.0 in increments of 0.1

- "Eighty nine point nine" (89.9)
- "Ninety" (90.0)
- "One hundred point five" (100.5)
- "One zero one point one" (101.1)
- "One zero eight" (108.0)

AM/MW band: 531 - 1602 in increments of 9

AM/LW band: 153 - 281 in increments of 1

- "Five thirty one" (531)
- "Nine hundred" (900)
- "Fourteen forty" (1440)
- "Fifteen zero three" (1503)
- "Ten eighty" (1080)

Store name

If you have tuned a radio station, you can store it with a name in the directory.

Steps	User says	System answer
1	"RADIO"	"RADIO"
2	"STORE NAME"	"STORE NAME" "NAME PLEASE"
3	"<name>"	"REPEAT NAME PLEASE"
4	"<name>"	"STORING NAME" "<name> STORED"

Voice control

Tune name

This function allows you to call up a stored radio station.

Steps	User says	System answer
1	"RADIO"	"RADIO"
2	"TUNE NAME"*	"NAME PLEASE"
3	"<name>"	"TUNE <name>"

* Can be used as a shortcut.

Delete name

This function allows you to delete a stored radio station.

Steps	User says	System answer
1	"RADIO"	"RADIO"
2	"DELETE NAME"	"NAME PLEASE"
3	"<name>"	"DELETE <name>" "CONFIRM YES OR NO"
4	"YES"	"DELETED"
	"NO"	"COMMAND CANCELLED"

Play directory

This function allows you to let the system tell you all of the stored radio stations.

Steps	User says	System answer
1	"RADIO"	"RADIO"
2	"PLAY DIRECTORY"	"PLAY <DIRECTORY>"

Delete directory

This function allows you to delete all stored radio stations at once.

Voice control

Steps	User says	System answer
1	"RADIO"	"RADIO"
2	"DELETE DIRECTORY"	"DELETE DIRECTORY" "CONFIRM YES OR NO"
3	"YES"	"RADIO DIRECTORY DELETED"
	"NO"	"COMMAND CANCELLED"

Play

This function switches the audio source to the radio mode.

Steps	User says	System answer
1	"RADIO"	"RADIO"
2	"PLAY"	

Auxiliary input

This function allows you to switch the audio source to the attached auxiliary input device.

Steps	User says	System answer
1	"EXTERNAL DEVICE"	"EXTERNAL DEVICE"
2	"LINE IN"	"LINE IN"

External devices - USB

These voice commands support the functionality of an external USB device which may be connected to the audio unit.

Overview

The overview below shows the available voice commands. The following lists will give further information about the complete command menu in selected examples.

"EXTERNAL DEVICE", "USB"
"HELP"

Voice control

"EXTERNAL DEVICE", "USB"
"PLAY"
"TRACK"*
"PLAYLIST"**
"FOLDER"**
"SHUFFLE ALL "
"SHUFFLE FOLDER"
"SHUFFLE PLAYLIST"
"SHUFFLE OFF"
"REPEAT TRACK"
"REPEAT FOLDER"
"REPEAT OFF"

* Can be used as a shortcut.

** Playlists and folders activated by voice control must be assigned special filenames. See **General information** (page 268).

USB play

This function allows you to switch the audio source to the attached USB device.

Steps	User says	System answer
1	"EXTERNAL DEVICE"	"EXTERNAL DEVICE"
2	"USB"	"USB"
3	"PLAY"	

USB Track

You can choose a track on your USB device directly.

Voice control

Steps	User says	System answer
1	"EXTERNAL DEVICE"	"EXTERNAL DEVICE"
2	"USB"	"USB"
3	"TRACK"	"TRACK NUMBER PLEASE"
4	"<a number between 1 and 99>"*	"TRACK <number>"

* Additionally, numbers can be spoken as up to four single digits (for example "2", "4", "5" for track 245)

External devices - iPod

These voice commands support the functionality of an iPod which may be connected to the audio unit.

Overview

The overview below shows the available voice commands. The following lists will give further information about the complete command menu in selected examples.

"EXTERNAL DEVICE", "IPOD"
"HELP"
"PLAY"
"TRACK"*
"PLAYLIST"**
"SHUFFLE ALL"
"SHUFFLE PLAYLIST"
"SHUFFLE OFF"
"REPEAT TRACK"
"REPEAT OFF"

* Can be used as a shortcut.

** Playlists activated by voice control must be assigned special filenames. See **General information** (page 268).

Voice control

iPod Track

You can choose a track off the all titles list of your iPod directly.

Steps	User says	System answer
1	"EXTERNAL DEVICE"	"EXTERNAL DEVICE"
2	"IPOD"	"IPOD"
3	"TRACK"*	"TRACK NUMBER PLEASE"
4	"<a number between 1 and 99>"**	"TRACK <number>"

* Can be used as a shortcut.

** Additionally, numbers can be spoken as up to five single digits (for example "5", "2", "4", "5", "3" for track 52453), to a limit of 65535.

iPod playlist

You can choose a playlist from your iPod directly.

Steps	User says	System answer
1	"EXTERNAL DEVICE"	"EXTERNAL DEVICE"
2	"IPOD"	"IPOD"
3	"PLAYLIST"*	"PLAYLIST NUMBER PLEASE"
4	"<a number between 1 and 10>"	"PLAYLIST <number>"

* Playlists activated by voice control must be assigned special filenames. See **General information** (page 268).

TELEPHONE COMMANDS

Phone

Your phone system allows you to create an additional phonebook. The stored entries can be dialed by voice control. Phone numbers stored by using voice control are stored on the vehicle system and not in your phone.

Overview

The overview below shows the available voice commands. The following lists will give further information about the complete command menu in selected examples.

Voice control

"PHONE"
"HELP"
"MOBILE NAME"*
"DIAL NUMBER"*
"DIAL NAME"*
"DELETE NAME"
"DELETE DIRECTORY"
"PLAY DIRECTORY"
"STORE NAME"
"REDIAL"*
"ACCEPT CALLS"
"REJECT CALLS"

* Can be used as a shortcut.

Phone functions

Dial number

Phone numbers can be dialled after giving the name tag voice command.

Steps	User says	System answer
1	"PHONE"	"PHONE"
2	"DIAL NUMBER"*	"NUMBER PLEASE"
3	"<phone number>"	"<phone number> CONTINUE?"
4	"DIAL "	"DIALLING"
	"CORRECTION"	"<repeat last part of number> CONTINUE?"

* Can be used as a shortcut.

Voice control

Dial name

Phone numbers can be dialled after giving the name tag voice command.

Steps	User says	System answer
1	"PHONE"	"PHONE"
2	"DIAL NAME"*	"NAME PLEASE"
3	"<name>"	"DIAL <name>" "CONFIRM YES OR NO"
4	"YES"	"DIALLING"
	"NO"	"COMMAND CANCELLED"

* Can be used as a shortcut.

Redial

This function allows you to redial the last dialled phone number.

Steps	User says	System answer
1	"PHONE"	"PHONE"
2	"REDIAL"*	"REDIAL" "CONFIRM YES OR NO"
3	"YES"	"DIALLING"
	"NO"	"COMMAND CANCELLED"

* Can be used as a shortcut.

Mobile name

This function allows you to access phone numbers stored with a name tag in your mobile phone.

Steps	User says	System answer
1	"PHONE"	"PHONE"
2	"MOBILE NAME"*	"MOBILE NAME" "<phone dependent dialogue>"

* Can be used as a shortcut.

Voice control

DTMF (Tone dialling)

This function transfers spoken numbers into DTMF tones. For example, to make a remote enquiry to your home answering machine or to enter a PIN number etc.

Note: DTMF can only be used during an ongoing call. Press the VOICE button and wait for the system prompt.

Can only be used with vehicles installed with a dedicated VOICE button.

Steps	User says	System answer
1		"NUMBER PLEASE"
2	"<numbers 1 to 9, zero, hash, star>"	

Create a phonebook

Store name

New entries can be stored with the "STORE NAME" command. This feature can be used to dial a number by calling up the name instead of the full phone number.

Steps	User says	System answer
1	"PHONE"	"PHONE"
2	"STORE NAME"	"STORE NAME" "NAME PLEASE"
3	"<name>"	"REPEAT NAME PLEASE"
4	"<name>"	"STORING NAME" "<name> STORED" "NUMBER PLEASE"
5	"<phone number>"	"<phone number>"
6	"STORE"	"STORING NUMBER" "<phone number>" "NUMBER STORED"

Delete name

Stored names can also be deleted from the directory.

Voice control

Steps	User says	System answer
1	"PHONE"	"PHONE"
2	"DELETE NAME"	"NAME PLEASE"
3	"<name>"	"DELETE <name>" "CONFIRM YES OR NO"
4	"YES"	"<name> DELETED"
	"NO"	"COMMAND CANCELLED"

Play directory

Use this function to let the system tell you all stored entries.

Steps	User says	System answer
1	"PHONE"	"PHONE"
2	"PLAY DIRECTORY"	"PLAY DIRECTORY"

Delete directory

This function allows you to delete all entries in one go.

Steps	User says	System answer
1	"PHONE"	"PHONE"
2	"DELETE DIRECTORY"	"DELETE DIRECTORY" "CONFIRM YES OR NO"
3	"YES"	"DIRECTORY DELETED"
	"NO"	"COMMAND CANCELLED"

Main settings

Reject calls

Calls can be set to be automatically rejected using voice control.

Voice control

Steps	User says	System answer
1	"PHONE"	"PHONE"
2	"REJECT CALLS"	"REJECT CALLS"
	"ACCEPT CALLS"*	"ACCEPT CALLS"

* use this command to turn the reject mode off

NAVIGATION SYSTEM COMMANDS

Please refer to your separate Navigation handbook for details of the command menus.

CLIMATE CONTROL COMMANDS

Climate

The climate voice commands supports the functionality of the fan speed, temperature and mode settings. Not all functions are available on all vehicles.

Overview

The overview below shows the available voice commands. The following lists will give further information about the complete command menu in selected examples.

"CLIMATE"
"HELP"
"FAN"*
"DEFROSTING/DEMISTING ON"*
"DEFROSTING/DEMISTING OFF"*
"TEMPERATURE"*
"AUTO MODE"*

* Can be used as a shortcut. On vehicles fitted with an English language module the "FAN" shortcut is not available.

Voice control

Fan

This function allows you to adjust the fan speed.

Steps	User says	System answer
1	"CLIMATE"	"CLIMATE"
2	"FAN"*	"FAN SPEED PLEASE"
3	"MINIMUM"	"FAN MINIMUM"
	"<a number between 1 and 7>"	"FAN <number>"
	"MAXIMUM"	"FAN MAXIMUM"

* Can be used as a shortcut. On vehicles fitted with an English language module the "FAN" shortcut is not available.

Defrosting/Demisting

Steps	User says	System answer
1	"CLIMATE"	"CLIMATE"
2	"DEFROSTING ON/DEMISTING ON"*	"DEFROSTING ON/DEMISTING ON"
	"DEFROSTING OFF/DEMISTING OFF"*	"DEFROSTING OFF/DEMISTING OFF"

* Can be used as a shortcut.

Temperature

This function allows you to adjust the temperature.

Steps	User says	System answer
1	"CLIMATE"	"CLIMATE"
2	"TEMPERATURE"*	"TEMPERATURE PLEASE"
3	"MINIMUM"	"TEMPERATURE MINIMUM"
	"<a number between 15 and 29 °C with 0.5 increments>" or "<a number between 59 and 84 °F>"	"TEMPERATURE <number>"

Voice control

Steps	User says	System answer
	"MAXIMUM"	"TEMPERATURE MAXIMUM"

* Can be used as a shortcut.

Auto mode

Steps	User says	System answer
1	"CLIMATE"	"CLIMATE"
2	"AUTO MODE"*	"AUTO MODE"

* Can be used as a shortcut. Can be deactivated by selecting a different temperature or fan speed.

Connectivity

GENERAL INFORMATION

CAUTIONS

 Take care when handling external devices with exposed electrical connectors (such as the USB plug). Always replace the protective cap/shield when possible. There may be a risk of electrostatic discharge causing damage to the device.

 Do not touch or handle the USB socket in the vehicle. Cover the socket when not in use.

 Only use USB Mass-Storage device compliant devices.

 Always switch your audio unit to a different source (for example the radio) before unplugging the USB device.

 Do not install or connect USB hubs or splitters.

Note: *The system is only designed to recognize and read suitable audio files from a USB device that conforms to the USB Mass-Storage device class or an iPod. Not all available USB devices can be guaranteed to function with the system.*

Note: *It is possible to connect compatible devices with a trailing USB lead as well as those that plug into the vehicle USB socket directly (for example USB memory sticks and pen drives).*

Note: *Some USB devices with a higher power consumption may not be compatible (for example some larger hard drives).*

Note: *Access time to read the files on the external device will vary depending upon factors such as the file structure, size and device content.*

The system supports a range of external devices, to fully integrate with your audio unit via the USB and auxiliary input sockets. Once connected, control of the external device is possible via the audio unit.

A list of typical compatible devices are shown below:

- USB memory sticks
- USB portable hard drives
- MP3 players with USB connection
- iPod media players (refer to **www.ford-mobile-connectivity.com** for latest compatibility list).

The system is USB 2.0 full speed compatible, USB 1.1 host compliant and supports FAT 16/32 file systems.

Information on audio file structures for external devices

USB

Create only a single partition on the USB device.

If playlists are created, they must contain correct file paths referenced to the USB device. It is recommended to create the playlist after the audio files have been transferred to the USB device.

Playlists must be created in .m3u format.

Audio files must be in .mp3 format.

Do not exceed the following limits:

- 1000 items per folder (files, folders and playlists)
- 5000 folders per USB device (including playlists)
- 8 subfolder levels.

Connectivity

To enable voice control for custom playlists and folders, follow the procedure below:

- Create folders named with the structure "**Ford<*>**" where <*> is a number 1-10. For example "**Ford3**" without an extension.
- Create playlists named with the structure "**Ford<*>.m3u**" where <*> is a number 1-10. For example "**Ford5.m3u**" without any space between "**Ford**" and the number.

Thereafter, custom folders and playlists will be selectable with voice control. See **Audio unit commands** (page 251).

iPod

To enable voice control for custom playlists, create playlists named with the structure "**Ford<*>**" where <*> is a number 1-10. For example "**Ford7**" without any space between "**Ford**" and the number.

Thereafter, playlists will be selectable with voice control. See **Audio unit commands** (page 251).

CONNECTING AN EXTERNAL DEVICE

WARNING



Make sure the external device is securely mounted within the vehicle, and that trailing connections do not obstruct any of the driving controls.

External devices may be connected using the auxiliary input socket and the USB port. See **Auxiliary input (AUX IN) socket** (page 124). See **USB port** (page 125).

Connection

Plug in the device, and if necessary secure it to prevent movement within the vehicle.

Connecting an iPod

For optimum convenience and audio quality, we recommend that you purchase a dedicated single connection lead available from your dealer.

Alternatively, it is possible to connect your iPod using the standard iPod USB cable and a separate 3.5mm audio jack lead. If using this method preset the iPod volume to maximum and turn off any equalizer settings before making the connections:

- Connect the headphone output of the iPod to the AUX IN socket.
- Connect the USB cable from the iPod to the vehicle USB socket.

CONNECTING AN EXTERNAL DEVICE - VEHICLES WITH: BLUETOOTH

Connecting a Bluetooth audio device

CAUTION



As various standards exist, manufacturers are able to implement a variety of profiles in their Bluetooth devices. Because of this, an incompatibility can occur between the Bluetooth device and the system, which in some cases may limit system functionality. To avoid this situation, only recommended devices should be used.

Please visit the website www.ford-mobile-connectivity.com for full details.

Connectivity

Bonding the device

Note: *Some audio and navigation units have a separate Bluetooth audio menu. Use this to access setup and control.*

To connect the device to the system follow the same procedure as for Bluetooth hands free phones. See

Bluetooth setup (page 244).

Operating the device

Select Bluetooth audio as the active source.

Tracks can be accessed by skipping forwards and backwards using the steering wheel controls, or directly from the audio unit controls.

USING A USB DEVICE

Various icons are used to identify types of audio file, folders etc.



USB device is the active source



Folder



Playlist



Album



Artist



Filename



Track title



Information not available

Sony radio

Operation

Select the USB device as the audio source by repeatedly pressing the **CD/AUX** button until USB appears in the display. After first connecting the USB device, the first track within the first folder will start to play automatically. Subsequently, following audio source switching, the position of playback on the USB device is remembered.

To browse the device contents, press the up/down arrow key or the OK button once.

The display will show the track information, together with other important information described below:

- A vertical scroll bar on the right side of the display shows the current position of the folder view.
- ">" after an entry indicates a further level down is readable (for example a folder named after an album, with individual album tracks within that folder).
- "<" before the list indicates that a further level up is readable.
- Icons to the left of track/folder text indicate the type of file/folder. Refer to the list for an explanation of these icons.

To navigate the USB device contents, use the up/down arrow keys to scroll through lists, and the left/right keys to move up or down within the folder hierarchy. Once your desired track, playlist or folder is highlighted, press the OK button to select playback.

Connectivity

Note: *If you wish to jump to the top level of the USB device contents, press and hold the left arrow key.*

Audio control

Press the left and right arrow keys to skip backwards and forwards through tracks.

Press and hold the left/right arrow keys to enable fast rewind/fast forward through track content.

Press the up/down arrow key or the OK button to browse the device contents.

Press the MENU key to enter the USB menu. It is possible to enable shuffle and repeat functions here with respect to folders and playlists.

Press the SCAN button to scan the whole device, current folder or a playlist if it is in operation.

Press the **INFO** button to display the following:

- filename
- title
- artist
- album
- track number and playing time.

Repeated button presses will scroll through these displays.

CD Navigation units

Operation

Select the USB device as the audio source by pressing the **CD/AUX** button until DEVICES appears in the display. Select DEVICES and then select USB from the available device list. After first connecting the USB device, the first track within the first folder will start to play automatically. Subsequently, following audio source switching, the position of playback on the USB device is remembered.

To browse the device contents, press the **SELECT** button once.

The display will show the track information, together with other important information described below:

- A vertical scroll bar on the right side of the display shows the current position of the folder view.
- ">" after an entry indicates a further level down is readable (for example a folder named after an album, with individual album tracks within that folder).
- "<" to the left hand side of the display indicates that a further level up is readable.
- Icons to the left of track/folder text indicate the type of file/folder. Refer to the list for an explanation of these icons.

To navigate the USB device contents, use the rotary scroll/select button to browse through lists. Push the button to expand the contents within the highlighted playlist or folder, or to commence playback of a particular track. Press **ESC** to go up one level.

Audio control

Press the **SEEK** up and down keys to skip backwards and forwards through tracks.

Press and hold the **SEEK** keys to enable fast rewind/fast forward through track content.

Rotate or press the **SELECT** button to browse the device contents.

Press SHUFFLE or REPEAT buttons to enable shuffle and repeat functions with respect to folders and playlists. Different options may appear depending upon whether or not a playlist is in operation.

Connectivity

Press the **SCAN** button to scan the current playlist if it is in operation, or the complete USB device or folder.

Press the **INFO** button to display the following:

- filename
- title
- artist
- album
- track number and playing time.

DVD Navigation units

Operation

Select the USB device as the audio source by pressing the **CD/AUX** button until the USB button appears to the left of the display. Select USB from the available device list.

Note: *Some devices may be shown but not selectable, depending if the device is connected or not.*

After first connecting the USB device, the first track within the first folder will start to play automatically. Subsequently, following audio source switching, the position of playback on the USB device is remembered.

To browse the device contents, press the scroll up or down arrow button.

The display will show the track information, together with other important information described below:

- A vertical scroll bar on the right side of the display shows the current position of the folder view.
- ">" after an entry indicates a further level down is readable (for example a folder named after an album, with individual album tracks within that folder).

- "<" to the left hand side of the display indicates that a further level up is readable.
- Icons to the left of track/folder text indicate the type of file/folder. Refer to the list for an explanation of these icons.

To navigate the USB device contents, use the scroll buttons to browse through lists. Push the button to expand the contents within the highlighted playlist or folder, or to commence playback of a particular track. Press the left arrow key to go up one level.

Audio control

Press the **SEEK** up and down keys to skip backwards and forwards through tracks.

Press and hold the **SEEK** keys to enable fast rewind/fast forward through track content.

Press the scroll bar arrow keys to browse the device contents.

Press **SHUFFLE** or **REPEAT** buttons to enable shuffle and repeat functions with respect to folders and playlists.

Press the **SCAN** button to scan the current playlist if it is in operation, or the complete USB device or folder.

Press the **INFO** button to display the following:

- filename
- title
- artist
- album
- track number and playing time.

USING AN IPOD

Various icons are used to identify types of audio file, folders etc.

Connectivity



iPod is the active source



iPod playlist



iPod artist



iPod album



iPod genre



iPod song



iPod generic category



iPod generic media file

Sony radio

Operation

Select the iPod as the audio source by repeatedly pressing the **CD/AUX** button until iPod appears in the display.

The iPod menu list for browsing contents will be available through the radio display. Navigation of the contents follows the same principles as for iPod standalone use (for example search by artist, title, etc.). To browse the iPod contents, press the up/down arrow key or the OK button once.

The display will show the track information, together with other important information described below:

- A vertical scroll bar on the right side of the display shows the current position of the list view.
- ">" after an entry indicates a further level down is readable (for example all albums by a particular artist).
- "<" before the list indicates that a further level up is readable.
- An icon on the left side indicates the type of the currently displayed list (for example list of albums). Refer to the list for an explanation of these icons.

To navigate the iPod contents, use the up/down arrow keys to scroll through lists, and the left/right keys to move up or down within the hierarchy. Once your desired track, playlist, album, artist or genre is highlighted, press the OK button to select playback.

Note: *If you wish to jump to the top level of the iPod contents, press and hold the left arrow key.*

Audio control

Press the left and right arrow keys to skip backwards and forwards through tracks.

Press and hold the left/right arrow keys to enable fast rewind/fast forward through track content.

Press the up/down arrow key or the OK button to browse the iPod contents.

Press the **MENU** key to enter the iPod menu. It is possible to enable shuffle and repeat functions here. It is also possible to enable the iPod "Shuffle songs" option directly from the top level.

Press the **SCAN** button to scan the currently selected tracks.

Connectivity

Press the **INFO** button to display the following:

- title
- artist
- track number and playing time.

Repeated button presses will scroll through these displays.

CD Navigation units

Operation

Select the iPod as the audio source by pressing the **CD/AUX** button until **DEVICES** appears in the display. Select **DEVICES** and then select iPod from the available device list.

The iPod menu list for browsing contents will be available through the display. Navigation of the contents follows the same principles as for iPod standalone use (for example search by artist, title, etc.). To browse the iPod contents, press the **SELECT** button once.

The display will show the track information, together with other important information described below:

- A vertical scroll bar on the right side of the display shows the current position of the list view.
- ">" after an entry indicates a further level down is readable (for example all albums by a particular artist).
- "<" before the list indicates that a further level up is readable.
- An icon on the left side indicates the type of the currently displayed list (for example list of albums). Refer to the list for an explanation of these icons.

To navigate the iPod contents, use the rotary scroll/select button to browse through lists. Push the button to expand the contents within the highlighted playlist, album, artist, genre or to commence playback of a particular track. Press **ESC** to go up one level.

Audio control

Press the **SEEK** up and down keys to skip backwards and forwards through tracks.

Press and hold the **SEEK** keys to enable fast rewind/fast forward through track content.

Rotate or press the **SELECT** button to browse the iPod contents.

Press the **MENU** key to enter the iPod menu. It is possible to enable shuffle and repeat functions here. It is also possible to enable the iPod "Shuffle songs" option directly from the top level.

Press the **SCAN** button to scan the currently selected tracks.

Press the **INFO** button to display the following:

- title
- artist
- track number and playing time.

DVD Navigation units

Operation

Select the iPod as the audio source by pressing the **CD/AUX** button until the iPod button appears to the left of the display. Select iPod from the available device list.

Note: *Some devices may be shown but not selectable, depending if the device is connected or not.*

Connectivity

The iPod menu list for browsing contents will be available through the display. Navigation of the contents follows the same principles as for iPod standalone use (for example search by artist, title, etc.). To browse the iPod contents, press the scroll up or down arrow button.

The display will show the track information, together with other important information described below:

- A vertical scroll bar on the right side of the display shows the current position of the list view.
- ">" after an entry indicates a further level down is readable (for example all albums by a particular artist).
- "<" before the list indicates that a further level up is readable.
- An icon on the left side indicates the type of the currently displayed list (for example list of albums). Refer to the list for an explanation of these icons.

To navigate the iPod contents, use the scroll buttons to browse through lists. Push the button to expand the contents within the highlighted playlist, album, artist, genre or to commence playback of a particular track. Press the left arrow key to go up one level.

Audio control

Press the **SEEK** up and down keys to skip backwards and forwards through tracks.

Press and hold the **SEEK** keys to enable fast rewind/fast forward through track content.

Press the scroll bar arrow keys to browse the iPod contents.

Press the MENU key to enter the iPod menu. It is possible to enable shuffle and repeat functions here. It is also possible to enable the iPod "Shuffle songs" option directly from the top level.

Press the SCAN button to scan the currently selected tracks.

Press the **INFO** button to display the following:

- title
- artist
- track number and playing time.

ROAD SAFETY

WARNINGS



The system provides you with information designed to help you reach your destination quickly and safely.



For reasons of safety, the driver should only program the system when the vehicle is stationary.



The system provides no assistance with respect to stop signs, traffic lights, areas under construction or other important safety information.



Do not use the system until you have familiarised yourself with its operation.



Only view the system display when driving conditions permit.

Safety information

Read and follow all stated safety precautions. Failure to do so may increase your risk of collision and personal injury. Ford Motor Company shall not be liable for any damages of any type arising from failure to follow these guidelines.

If detailed viewing of route instructions is necessary, pull off the road when it is safe to do so and park your vehicle.

Do not use the navigation system to locate emergency services.

To use the system as effectively and safely as possible, always use the latest navigation information. Your dealer will be able to assist with this.

Navigation system

GETTING STARTED

CAUTION

 Using the system with the engine off will drain the battery.

Note: You will be charged when sending and receiving text messages.

Note: Refer to your phone handbook for all phone functions and operation.

Note: Keep the activation code (printed on the installation guide) in a safe place.

Note: Retain the activation text message in your mobile phone inbox.

Compatibility of phones

CAUTION

 As no common agreement exists, mobile phone manufacturers are able to implement a variety of profiles in their Bluetooth devices. Because of this, an incompatibility can occur between the phone and hands-free system, which in some cases may significantly degrade the system performance. To avoid this situation, only recommended phones should be used.

Please visit the website www.ford-mobile-connectivity.com for full details.

Installing the micro SD card

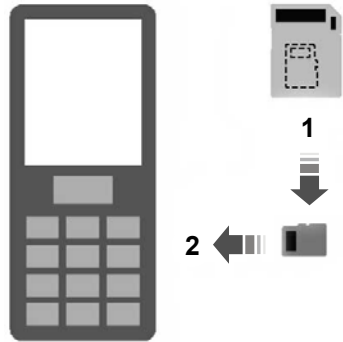

E114212

1. Remove the micro SD card from the adaptor.
2. Insert the micro SD card into the mobile phone.

Activating the mobile phone navigation system

Note: The radio must be switched on before connecting the mobile phone to the in-car GPS receiver.

Note: The Ford Mobile Navigation must be installed and activated on your mobile phone.

Note: It is possible to activate up to a **maximum** of three phones.

Note: Detailed instructions are available on the micro SD card and at www.ford-mobile-connectivity.com.

1. Switch the radio on.

Navigation system



E114213

2. Switch your mobile phone on and start the "Ford Mobile Navigation".
3. Choose "Select Destination".
4. Choose "Enter Address".
5. Change route options if necessary and start the route guidance.
6. The vehicle display will show the turn information. Voice instructions are heard via the vehicle speakers.

Note: *Your mobile phone will display your current position.*

7. You are able to exit the application and continue your route guidance after restarting the application.

Appendices

TYPE APPROVALS

FCC/INDUSTRY CANADA NOTICE

This device complies with Part 15 of the FCC Rules. Operation is subject to the following two conditions: (1) this device may not cause harmful interference, and (2) this device must accept any interference received, including interference that may cause undesired operation.

FCC ID: WJLRX-42

IC: 7847A-RX42

Changes or modifications to your device not expressly approved by the party responsible for compliance can void the user's authority to operate the equipment.

RX-42 - declaration of conformity

We, the party responsible for compliance, declare under our sole responsibility that the Handset Integration product RX-42 is in conformity with the provisions of the following Council Directive: 1999/5/EC. A copy of the Declaration of Conformity can be found at:

www.novero.com/declaration_of_conformity

The Bluetooth word mark and logos are owned by the Bluetooth SIG, Inc. and any use of such marks by Ford Motor Company is under license. Other trademarks and trade names are those of their respective owners.

TYPE APPROVALS

iPod is a trademark of Apple Inc.

TYPE APPROVALS



© 2008 NAVTEQ B.V. All rights reserved.

Appendices

(AT)	"© Bundesamt für Eich- und Vermessungswesen"
(PL)	"© EuroGeographics"
(FR)	"source: Géoroute® IGN France & BD Carto® IGN France"
(DE)	"Die Grundlagendaten wurden mit Genehmigung der zuständigen Behörden entnommen"
(GB)	"Based upon Crown Copyright material."
(GR)	"Copyright Geomatics Ltd."
(IT)	"La Banca Dati Italiana è stata prodotta usando quale riferimento anche cartografia numerica ed al tratto prodotta e fornita dalla Regione Toscana."
(NO)	"Copyright © 2000; Norwegian Mapping Authority"
(PT)	"Source: IgeoE – Portugal"
(ES)	"Información geográfica propiedad del CNIG"
(SE)	"Based upon electronic data © National Land Survey Sweden."
(CH)	"Topografische Grundlage: © Bundesamt für Landestopographie"

ELECTROMAGNETIC COMPATIBILITY

WARNINGS

 Your vehicle has been tested and certified to European legislations relating to electromagnetic compatibility (2004/104/EC). It is your responsibility to ensure that any equipment you have fitted complies with applicable local legislations. Have any equipment fitted by properly trained technicians.

WARNINGS

 Radio frequency (RF) transmitter equipment (e.g. cellular telephones, amateur radio transmitters etc.) may only be fitted to your vehicle if they comply with the parameters shown in the table below. There are no special provisions or conditions for installations or use.

 Do not mount any transceiver, microphones, speakers, or any other item in the deployment path of the airbag system.

 Do not fasten antenna cables to original vehicle wiring, fuel pipes and brake pipes.

Appendices

WARNINGS



Keep antenna and power cables at least 100mm from any electronic

WARNINGS

modules and airbags.

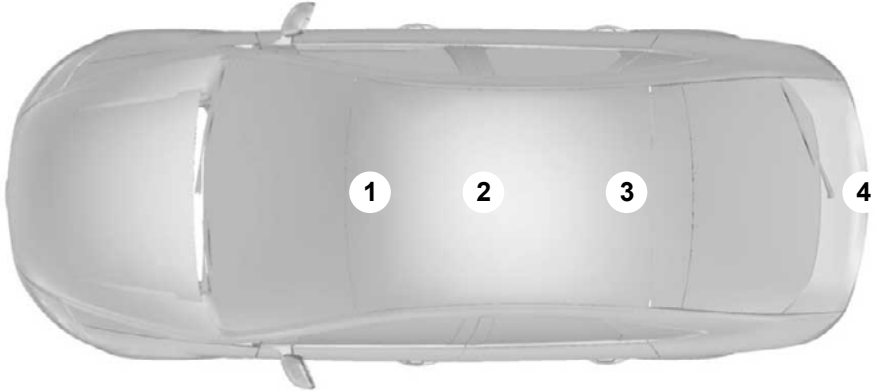

E85998

Frequency Band MHz	Maximum output power Watt (Peak RMS)	Antenna Positions
1 – 30	50 W	3, 8
30 – 54	50 W	2, 3
68 – 87.5	50 W	1, 2, 3, 4, 5
142 – 176	50 W	1, 2, 3, 4, 5
380 – 512	50 W	1, 2, 3, 4, 5
806 – 940	10 W (2 W ¹)	1, 2, 3, 4, 5 (6 ¹ , 7 ¹)
1200 – 1400	10 W	2
1710 – 1885	10 W (1 W ¹)	1, 2, 3, 4, 5 (6 ¹ , 7 ¹)
1885 – 2025	10 W (1 W ¹)	1, 2, 3, 4, 5 (6 ¹ , 7 ¹)
2400 – 2500	0.1 W	All positions

¹Only for GSM/3G cellular phones, with a patch antenna installed inside of the front windshield.

Appendices

Note: *After the installation of RF transmitters, check for disturbances from and to all electrical equipment in the vehicle, both in the standby and transmit modes.*

Check all electrical equipment:

- with the ignition **ON**
- with the engine running
- during a road test at various speeds.

Check that electromagnetic fields generated inside the vehicle cabin by the transmitter installed do not exceed human exposure limits specified in EU directive 2004/40/EC.

Index

A

- A/C
See: Climate control.....100
- About this handbook.....7
- ABS
See: Brakes.....141
- ABS driving hints
See: Hints on driving with ABS.....141
- ACC
See: Adaptive cruise control (ACC).....151
- Accessories
See: Parts and accessories.....7
See: Using ACC.....152
- Active suspension.....146
Principle of operation.....146
- Active suspension
See: Using active suspension.....146
- Adaptive cruise control (ACC).....151
Principle of operation.....151
- Adaptive cruise control (ACC)
See: Using ACC.....152
- Adaptive front lighting system
(AFS).....55
Cornering lamps.....56
- Adjusting the headlamps - Vehicles
With: Adaptive Front Lighting/Xenon
Headlamps.....54
- Adjusting the steering wheel.....46
- AFS
See: Adaptive front lighting system
(AFS).....55
- Air conditioning
See: Climate control.....100
- Air vents.....100
Front air vents.....100
Rear air vents.....100
- Alarm.....43
Principle of operation.....43
- Appendices.....279
- Arming the alarm.....45
- Arming the engine immobiliser.....42
- Ashtray.....121
Front ashtray.....121
Rear ashtray.....121
- Audible warnings and indicators.....77
Switching the chimes on and off.....77
- Audio control.....46
Mode.....46
Seek.....47
- Audio unit commands.....251
- Auxiliary input.....257
- CD Changer.....252
- CD Player.....251
- External devices - iPod.....259
- External devices - USB.....257
- Radio.....254
- Auto-dimming mirror.....72
- Autolamps.....53
- Automatic climate control.....103
- Air distribution.....104
- Blower.....104
- Mono mode.....104
- Recirculated air.....105
- Setting the temperature.....104
- Switching the air conditioning on and
off.....105
- Switching the automatic climate control
on and off.....105
- Windscreen defrosting and
demisting.....105
- Automatic transmission.....138
- Drive modes.....139
- Emergency park position release
lever.....139
- Hints on driving with an automatic
transmission.....139
- Selector lever positions.....138
- Autowipers.....48
- Auxiliary heater.....106
Changing the remote control
battery.....109
- Diesel auxiliary heater (depending on
country).....110
- Feedback during starting and switching
off.....109
- Fuel operated heater (depending on
country).....110
- Parking heater.....106
- Programming the transmitter.....109
- Remote start in combination with direct
start or timer.....109
- Remote starting.....108
- Auxiliary input (AUX IN) socket.....124
- Auxiliary power sockets.....121

Index

- B**
- Battery connection points.....218
 - Bluetooth setup.....244
 - Handling of phones.....244
 - Requirements for Bluetooth connection.....244
 - Bonnet lock
 - See: Opening and closing the bonnet....199
 - Booster cables
 - See: Using booster cables.....217
 - Booster cushions.....19
 - Booster cushion.....19
 - Booster seat.....19
 - Integrated booster cushion.....20
 - Brake and clutch fluid check.....211
 - Brakes.....141
 - Principle of operation.....141
 - Bulb changing
 - See: Changing a bulb.....59
 - Bulb specification chart.....66
- C**
- Cargo nets.....162
 - Luggage retention net.....162
 - Car wash
 - See: Cleaning the exterior.....215
 - Catalytic converter.....133
 - Driving with a catalytic converter.....133
 - CD changer.....124
 - Changing a bulb.....59
 - Approach lamp.....61
 - Central high mounted brake lamp.....63
 - Front fog lamps.....61
 - Headlamp.....59
 - Interior lamp.....65
 - Luggage compartment lamp.....66
 - Number plate lamp.....65
 - Reading lamps.....65
 - Rear lamps.....62
 - Side repeaters.....61
 - Vanity mirror lamp.....66
 - Changing a fuse.....176
 - Changing a road wheel.....219
 - Assembling the wheel brace.....221
 - Installing a road wheel.....223
 - Jacking and lifting points.....220
 - Locking wheel nuts.....219
 - Removing a road wheel.....222
 - Removing the wheel trim.....222
 - Vehicle jack.....219
 - Vehicles with a temporary spare wheel.....219
 - Changing the remote control battery.....31
 - Remote control with a folding key blade.....31
 - Remote control without a folding key blade.....32
 - Changing the wiper blades.....50
 - Rear window wiper blades.....51
 - Windscreen wiper blades.....50
 - Checking the wiper blades.....50
 - Child safety.....18
 - Child safety locks.....24
 - Left-hand side.....25
 - Right-hand side.....25
 - Child seat positioning.....21
 - Child seats.....18
 - Child restraints for different mass groups.....18
 - Cigar lighter.....120
 - Cleaning the exterior.....215
 - Body paintwork preservation.....215
 - Cleaning the chrome trim.....215
 - Cleaning the headlamps.....215
 - Cleaning the rear window.....215
 - Cleaning the interior.....215
 - Instrument cluster screens, LCD screens, radio screens.....216
 - Seat belts.....215
 - Climate control.....100
 - Principle of operation.....100
 - Climate control commands.....265
 - Climate.....265
 - Clock.....120
 - Coded keys.....42
 - Cold weather precautions.....172
 - Connecting an external device.....269
 - Connection.....269

Index

Connecting an external device - Vehicles With: Bluetooth.....	269
Connecting a Bluetooth audio device.....	269
Connectivity.....	268
General information.....	268
Convenience features.....	120
Coolant check See: Engine coolant check.....	210
Cruise control.....	149
Principle of operation.....	149
Cruise control See: Using cruise control.....	149
Cup holders.....	122
D	
Detachable tow ball.....	168
Driving with a trailer.....	170
Driving without a trailer.....	171
Inserting the tow ball arm.....	169
Maintenance.....	171
Removing the tow ball arm.....	170
Unlocking the tow ball arm mechanism.....	169
Diesel particulate filter (DPF).....	130
Regeneration.....	130
Direction indicators.....	57
Disabling the passenger airbag.....	29
Disabling the passenger airbag.....	30
Enabling the passenger airbag.....	30
Fitting the passenger airbag deactivation switch.....	30
Disarming the alarm.....	45
Vehicles with keyless entry.....	45
Vehicles without keyless entry.....	45
Disarming the engine immobiliser.....	42
Dog guard.....	164
Installing behind the front seats.....	164
Installing behind the rear seats.....	165
DPF See: Diesel particulate filter (DPF).....	130
Driving hints.....	172
Driving through water.....	172
Driving through water	172

E

Electric exterior mirrors.....	70
Electric folding mirrors.....	71
Mirror tilting positions.....	70
Reverse mirror dipping.....	71
Electric seats.....	115
2-way electric seat.....	115
8-way electric seat.....	116
Electric sunroof.....	111
Opening and closing the sunroof.....	111
Opening and closing the sunroof automatically.....	112
Sunroof anti-trap protection.....	112
Sunroof relearning.....	113
Sunroof safety mode.....	113
Tilting the sunroof.....	112
Electric windows.....	68
Anti-trap function.....	69
Driver's door switches.....	68
Front and rear passengers' door switches.....	68
Global opening and global closing.....	68
Opening and closing the windows automatically.....	68
Resetting the memory of the electric windows.....	69
Safety mode.....	70
Safety switch for rear windows.....	69
Electromagnetic compatibility.....	280
Emergency equipment.....	173
Engine compartment overview - 1.6L Duratec-16V Ti-VCT (Sigma).....	200
Engine compartment overview - 1.8L Duratorq-TDCi (Lynx) Diesel.....	205
Engine compartment overview - 2.0L Duratec-HE (M14).....	201
Engine compartment overview - 2.0L Duratorq-TDCi (DW) Diesel.....	206
Engine compartment overview - 2.0L EcoBoost SCTi (M14).....	202
Engine compartment overview - 2.2L Duratorq-TDCi (DW) Diesel.....	207
Engine compartment overview - 2.3L Duratec-HE (M14).....	203
Engine compartment overview - 2.5L Duratec (V15).....	204

Index

- Engine coolant check.....210
 Checking the coolant level.....210
 Topping up.....210
Engine heater.....131
Engine immobiliser.....42
 Principle of operation.....42
Engine oil check.....210
 Checking the oil level.....210
 Topping up.....210
Engine oil dipstick - 1.6L Duratec-16V
 Ti-VCT (Sigma).....208
Engine oil dipstick - 1.8L Duratorq-TDCi
 (Lynx) Diesel.....209
Engine oil dipstick - 2.0L Duratec-HE
 (M14)/2.3L Duratec-HE (M14).....208
Engine oil dipstick - 2.0L Duratorq-TDCi
 (DW) Diesel/2.2L Duratorq-TDCi (DW)
 Diesel.....209
Engine oil dipstick - 2.0L EcoBoost SCTi
 (M14).....209
Engine oil dipstick - 2.5L Duratec
 (V15).....209
Exterior mirrors.....70
 Manual folding mirrors.....70
- ## F
- Fastening the seat belts.....28
First aid kit.....173
Floor mats.....125
Fog lamp
 See: Front fog lamps.....53
Forward alert function.....155
 Adjusting the warning sensitivity.....156
 Switching forward alert on and off.....156
Front fog lamps.....53
Fuel and refuelling.....132
 Technical specifications.....134
Fuel burning heater
 See: Auxiliary heater.....106
Fuel consumption.....134
Fuel consumption
 See: Technical specifications.....134
Fuel filler flap.....133
 Vehicles with diesel engine.....134
Fuel quality - Diesel.....132
 Long-term storage.....133
Fuel quality - E85.....132
 Long-term storage.....132
Fuel quality - Petrol.....132
Fuse box locations.....174
 Central fuse box.....174
 Engine compartment fuse box.....174
 Rear fuse box - 4-door and 5-door.....175
 Rear fuse box - Estate.....175
Fuses.....174
Fuse specification chart - Vehicles Built
 From: 08-02-2010.....186
 Central fuse box.....190
 Engine compartment fuse box.....186
 Rear fuse box.....192
Fuse specification chart - Vehicles Built
 Up To: 07-02-2010.....177
 Central fuse box.....180
 Engine compartment fuse box.....177
 Rear fuse box.....182
- ## G
- Gauges.....73
 Engine coolant temperature gauge.....74
 Fuel gauge.....74
Gearbox
 See: Transmission.....138
General driving points - Vehicles With:
 Sports Suspension.....172
General information on radio
 frequencies.....31
Getting started.....277
 Activating the mobile phone navigation
 system.....277
 Compatibility of phones.....277
 Installing the micro SD card.....277
Glasses holder.....124
Global opening and closing.....37
 Global closing.....38
 Global opening.....38
Glove box.....122
 Cooled glove box.....122
- ## H
- Handbrake
 See: Parking brake.....141
Hazard warning flashers.....55

Index

Headlamp adjustment	
See: Adjusting the headlamps - Vehicles	
With: Adaptive Front Lighting/Xenon	
Headlamps.....	54
Headlamp levelling.....	54
Recommended headlamp levelling switch	
positions.....	54
Headlamp washers.....	50
Head restraints.....	117
Adjusting the head restraint.....	117
Removing the head restraint.....	117
Heated seats.....	118
Heated windows and mirrors.....	105
Heated exterior mirrors.....	106
Heated windows.....	105
Heating	
See: Climate control.....	100
Hill launch assist (HLA)	
See: Using hill start assist.....	143
Hill start assist.....	143
Principle of operation.....	143
Hints on driving with ABS.....	141
HLA	
See: Hill start assist.....	143
See: Using hill start assist.....	143
I	
Ignition switch.....	126
Immobiliser	
See: Engine immobiliser.....	42
Information displays.....	78
General information.....	78
Information messages.....	91
Active suspension.....	92
Airbag.....	92
Alarm.....	92
Battery and charging system.....	93
Climate control.....	93
Cruise control and Adaptive cruise control	
(ACC).....	93
Doors open.....	94
Engine immobiliser.....	94
Hill launch assist (HLA).....	94
Keyless system.....	95
Lighting.....	95
Maintenance.....	96
Message indicator.....	91
Message symbols.....	91
Occupant protection.....	96
Parking brake.....	96
Power steering.....	97
Stability control (ESP).....	97
Transmission.....	97
Tyre pressure monitoring system.....	97
Viewing current messages.....	91
Voice control.....	99
Instrument lighting dimmer.....	120
Instruments.....	73
Interior lamps.....	57
Courtesy lamp.....	57
Reading lamps.....	57
Vanity mirror lamps.....	58
Introduction.....	7
ISOFIX anchor points.....	23
Attaching a child seat with top	
tethers.....	23
Top tether anchor points.....	23
J	
Jump starting	
See: Using booster cables.....	217

Index

- K**
- Keyless entry.....39
 - Disabled keys.....41
 - General information.....39
 - Locking and unlocking the doors with the key blade.....41
 - Locking the vehicle.....39
 - Passive key.....39
 - Unlocking the vehicle.....40
 - Keyless starting.....126
 - Failure to start.....127
 - Ignition on.....126
 - Starting a diesel engine.....127
 - Starting with automatic transmission.....127
 - Starting with manual transmission.....127
 - Stopping the engine.....128
 - Keys and remote controls.....31
- L**
- Lighting control.....52
 - Headlamp flasher.....52
 - Home safe lighting.....53
 - Lighting control positions.....52
 - Main and dipped beam.....52
 - Parking lamps.....52
 - Lighting.....52
 - Load carriers
 - See: Roof racks and load carriers.....164
 - Load carrying.....159
 - General information.....159
 - Load retaining fixtures.....166
 - Installing the load bracket.....166
 - Installing the load retaining fixtures.....166
 - Locking and unlocking.....35
 - Automatic relocking.....37
 - Central locking.....35
 - Double locking.....35
 - Double locking the doors with the key.....35
 - Locking and unlocking confirmation.....35
 - Locking and unlocking the doors and the luggage compartment lid with the remote control.....36
 - Locking and unlocking the doors from inside.....36
 - Locking and unlocking the doors with the key.....35
 - Luggage compartment lid.....37
 - Reprogramming the unlocking function.....37
 - Locks.....35
 - Luggage anchor points.....159
 - 4-door and 5-door.....160
 - Estate.....159
 - Luggage covers.....163
- M**
- Maintenance.....198
 - General information.....198
 - Technical specifications.....212
 - Manual climate control.....101
 - Air conditioning.....102
 - Air distribution control.....101
 - Blower.....101
 - Heating the interior quickly.....101
 - Recirculated air.....101
 - Ventilation.....102
 - Manual seats.....114
 - Adjusting the angle of the seatback.....115
 - Adjusting the height of the driver's seat.....115
 - Adjusting the lumbar support.....115
 - Moving the seats backwards and forwards.....114
 - Manual transmission.....138
 - Map pockets.....123
 - Memory function.....123
 - Recalling a stored seat position.....124
 - Setting a memory pre-set.....123

Index

- Message centre
See: Information displays.....78
- Mirrors
See: Heated windows and mirrors.....105
See: Windows and mirrors.....68
- ## N
- Navigation introduction.....276
- Navigation system commands.....265
- Navigation system.....277
- ## O
- Occupant protection.....26
Principle of operation.....26
- Oil check
See: Engine oil check.....210
- See: Opening and closing the bonnet....199
- ## O
- Opening and closing the bonnet.....199
Closing the bonnet.....199
Opening the bonnet.....199
- ## P
- Parking aid.....147
Principle of operation.....147
- Parking aid
See: Using the parking aid.....147
- Parking brake.....141
Applying the parking brake.....141
Parking on a hill.....141
Releasing the parking brake.....141
- Parts and accessories.....7
Look for the Ford logo on the following
parts8
Now you can be sure that your Ford parts
are Ford parts.....7
- Personalised settings.....89
Help screen, radio, navigation and phone
information.....89
Language.....90
Navigation information.....89
Units of measure.....90
- Power steering fluid check.....211
Topping up.....211
- Programming the remote control.....31
Programming a new remote control.....31
Reprogramming the unlocking
function.....31
- ## Q
- Quick start.....10
Adjusting the steering wheel.....13
Autolamps.....14
Automatic climate control.....15
Automatic transmission.....17
Autowipers.....14
Diesel particulate filter (DPF).....16
Electric folding mirrors.....14
Engine idle speed after starting.....15
Fuel filler flap.....16
Information displays.....15
Instrument panel overview - left-hand
drive.....10
Instrument panel overview - right-hand
drive.....11
Keyless entry.....12
Keyless starting.....16
Manual climate control.....15
Manual transmission.....17
Speed limiter.....17
Towing the vehicle on four wheels.....17
- ## R
- Rear fog lamps.....53
- Rear seats.....117
Creating a level load floor.....117
Folding the seatbacks down.....117
Folding the seatbacks up.....118
- Rear under floor storage.....162
Vehicles with a sliding loadspace
floor.....162
Vehicles without a sliding loadspace
floor.....162
- Rear window wiper and washers.....49
Intermittent wipe.....49
Reverse gear wipe.....49
Washer.....49
- Refuelling - E85.....134

Index

Refuelling.....	134
Remote control battery	
See: Changing the remote control battery.....	31
Remote control programming	
See: Programming the remote control.....	31
Removing a headlamp.....	58
Repairing minor paint damage.....	216
Road Safety.....	276
Safety information.....	276
Roof racks and load carriers.....	164
Roof rack.....	164
Run flat tyres.....	224
Principle of operation.....	224
Replacing run flat tyres.....	224
What to do if a run flat tyre has a puncture.....	224
Running-in.....	172
Brakes and clutch.....	172
Engine.....	172
Tyres.....	172

S

Seat belt height adjustment.....	29
Seat belt reminder.....	29
Deactivating the seat belt reminder.....	29
Seats.....	114
Sitting in the correct position.....	114
Sliding loadspace floor.....	160
Storage compartment.....	161
Snow chains	
See: Using snow chains.....	229
Speed control	
See: Cruise control.....	149
Speed limiter.....	157
Principle of operation.....	157
Stability control.....	142
Principle of operation.....	142
Stability control	
See: Using stability control.....	142
Starter switch	
See: Ignition switch.....	126
Starting a diesel engine.....	130
Cold or hot engine.....	130
Starting a petrol engine - E85.....	129
Starting at low ambient temperatures.....	129

Starting a petrol engine.....	128
Cold or hot engine.....	128
Engine idle speed after starting.....	129
Flooded engine.....	129
Starting the engine.....	126
General information.....	126
Steering wheel lock.....	128
Vehicles with keyless starting.....	128
Vehicles without keyless starting.....	128
Steering wheel.....	46
Storage compartments.....	122
Sun blinds.....	120
Sunroof	
See: Electric sunroof.....	111
Switching off the engine.....	131
Vehicles with a turbocharger.....	131
Symbols glossary.....	7
Symbols in this handbook.....	7
Symbols on your vehicle.....	7

T

Technical specifications.....	235
Technical specifications.....	235
Telephone commands.....	260
Create a phonebook.....	263
Main settings.....	264
Phone.....	260
Phone functions.....	261
Telephone controls.....	245
Remote control.....	245
Telephone setup.....	243
Bond another Bluetooth phone.....	244
Making a phone an active phone.....	243
Phonebook.....	243
Phonebook categories.....	243
Telephone.....	243
General information.....	243
Telephone	
See: Using the telephone - Vehicles With: Navigation System.....	248
See: Using the telephone - Vehicles Without: Navigation System.....	245
Towing a trailer.....	168
Steep gradients.....	168
Towing points.....	196

Index

Towing the vehicle on four wheels.....	196
All vehicles.....	196
Vehicles with 2.0L Duratorq-TDCi (DW) Diesel (Stage V) or 2.0L EcoBoost SCTi (M14) and 6-Speed Automatic Transmission.....	197
Vehicles with automatic transmission, except 2.0L Duratorq-TDCi (DW) Diesel (Stage V) or 2.0L EcoBoost SCTi (M14) with 6-Speed Automatic Transmission.....	196
Towing.....	168
Transmission.....	138
Trip computer.....	87
Average fuel consumption.....	87
Average speed.....	87
Distance to empty.....	87
Odometer.....	87
Outside air temperature.....	87
Tripmeter.....	87
Type 1 and 2.....	88
Type 3.....	88
Type approvals.....	279
FCC/INDUSTRY CANADA NOTICE.....	279
RX-42 - declaration of conformity.....	279
Tyre care.....	229
Tyre pressure monitoring system.....	229
Checking the tyre pressures.....	230
Setting the vehicle load.....	230
Tyre pressures	
See: Technical specifications.....	231
Tyre repair kit.....	225
Checking the tyre pressure.....	228
General information.....	225
Inflating the tyre.....	226
Using the tyre repair kit.....	225
Tyres	
See: Wheels and tyres.....	219
U	
USB port.....	125
Using ACC.....	152
Automatic deactivation.....	155
Cancelling ACC.....	154
Changing the set speed.....	153
Resuming ACC.....	155
Setting a speed.....	153
Setting the vehicle gap.....	154
Switching ACC off.....	155
Switching ACC on.....	153
Using active suspension.....	146
Selecting a setting.....	146
System malfunction.....	146
Using an iPod.....	272
CD Navigation units.....	274
DVD Navigation units.....	274
Sony radio.....	273
Using a USB device.....	270
CD Navigation units.....	271
DVD Navigation units.....	272
Sony radio.....	270
Using booster cables.....	217
To connect the booster cables.....	217
To start the engine.....	217
Using cruise control.....	149
Cancelling the set speed.....	149
Changing the set speed.....	149
Resuming the set speed.....	150
Setting a speed.....	149
Switching cruise control off.....	150
Switching cruise control on.....	149
Using hill start assist.....	143
Activating the system.....	144
Deactivating the system.....	145
Using seat belts during pregnancy.....	29
Using snow chains.....	229
Using stability control.....	142
Using the parking aid.....	147
Manoeuvring with the parking aid.....	147
Switching the parking aid on and off.....	147
Using the speed limiter.....	157
Intentionally exceeding the speed limit.....	157
Setting the speed limit.....	157
System warnings.....	158

Index

Using the telephone - Vehicles With:	
Navigation System.....	248
Changing the active phone.....	249
Debonding a bonded phone.....	249
Making a call.....	248
Muting the microphone.....	248
Receiving an incoming call.....	248
Receiving a second incoming call.....	248
Using the telephone - Vehicles Without:	
Navigation System.....	245
Changing the active phone.....	247
Debonding a bonded phone.....	247
Debonding a bonded phone - Sony radio.....	247
Making a call.....	245
Muting the microphone.....	247
Receiving an incoming call.....	246
Receiving a second incoming call.....	246
Using voice control.....	250
Name tag.....	251
System operation.....	250
Using winter tyres.....	229

V	
Vehicle battery.....	217
Vehicle care.....	215
Vehicle identification number (VIN).....	234
Vehicle identification plate.....	234
Vehicle identification.....	234
Vehicle recovery.....	196
Ventilated seats.....	118
Ventilation See: Climate control.....	100
Vents See: Air vents.....	100
VIN See: Vehicle identification number (VIN).....	234
Voice control.....	250
Principle of operation.....	250

W

Warning lamps and indicators.....	75
ABS warning lamp.....	75
Airbag warning lamp.....	75
Brake system lamp.....	75
Cruise control indicator.....	75
Direction indicators.....	75
Engine warning lamp.....	75
Forward alert indicator.....	76
Front fog lamp indicator.....	76
Frost warning lamp.....	76
Glow plug indicator.....	76
Headlamp indicator.....	76
Ignition warning lamp.....	76
Low fuel level warning lamp.....	76
Main beam indicator.....	76
Message indicator.....	76
Oil pressure warning lamp.....	76
Rear fog lamp indicator.....	77
Seat belt reminder.....	77
Shift indicator.....	77
Stability control (ESP) warning lamp.....	77
Warning triangle.....	173
4-door and 5-door.....	173
Estate and vehicles with tyre repair kit.....	173
Washer fluid check.....	211
Washers See: Wipers and washers.....	48
Washing See: Cleaning the exterior.....	215
Wheels and tyres.....	219
General information.....	219
Technical specifications.....	231
Windows and mirrors.....	68
Windscreen washers.....	49
Windscreen wipers.....	48
Intermittent wipe.....	48
Winter tyres See: Using winter tyres.....	229
Wipers and washers.....	48

Feel the difference

