

## ABOUT THIS MANUAL

Ford Motor Company salutes the towing industry and applauds you for your many fine years of service to the automotive industry. We will continue to work with you to provide our customers and yours with damage-free towing.

This manual contains the latest towing procedures for 2003 Ford, Lincoln and Mercury passenger cars and light trucks. As you turn the pages of this book, you will find the instructions easy to follow with clear illustrations showing the correct hook-up for damage-free towing.

As an additional safety measure, be sure you use safety chains on every tow, including wheel lift and flat bed hook-ups. This will prevent you from losing the vehicle in the event of equipment failure or vehicle breakage at the tow chain attachment.

New materials and aerodynamic styling require new methods of towing to eliminate the possibility of vehicle towing damage. Wheel lifts and flatbed equipment are required to tow many vehicles. Refer to the instructions given for the specific vehicle you are towing.

# FOREWORD

**This manual contains information and procedures for towing Ford Motor Company passenger cars and light trucks using slingbelt wrecker equipment.**

**CAUTION: To avoid personal injury and/or vehicle damage, carefully follow procedures in this manual.**

**NOTE: Due to the many variations of wheel lift and flat bed equipment, instructions for their usage are not included in this manual. Refer to the instruction manuals supplied with wheel lift and flat bed equipment.**

# TABLE OF CONTENTS

	Page
Foreword .....	2
<b>TOWING EQUIPMENT .....</b>	<b>4</b>
<b>GENERAL TOWING INFORMATION — PASSENGER CARS .....</b>	<b>5-6</b>
<b>WRECKER TOWING FORD VEHICLES WITH AIR BAGS .....</b>	<b>7</b>
<b>PASSENGER CAR TOWING</b>	
ZX2 .....	8-9
Taurus, Sable .....	10-11
Mustang .....	12-13
Town Car, Crown Victoria, Grand Marquis .....	14-15
Focus .....	16-17
Lincoln LS .....	18-19
Thunderbird .....	20-21
<b>GENERAL TOWING INFORMATION — LIGHT TRUCKS .....</b>	<b>22-24</b>
<b>WRECKER TOWING FORD VEHICLES WITH AIR BAGS .....</b>	<b>25</b>
<b>LIGHT TRUCK TOWING</b>	
Windstar .....	26-28
Aviator, Explorer, Mountaineer .....	29-30
Sport, Sport-Trac .....	31-32
Ranger .....	33-34
F-150, SVT Lightning, Harley Davidson Supercrew, Navigator, Expedition, Blackwood .....	35
F-Super Duty (F-250, F-350, F-450, F-550) .....	36-37
Excursion .....	38-39
Escape .....	40-41
E-Series, Club Wagon, E-150, E-250, E-350, E-450, E-Sport .....	42-43
<b>2003 FORD SERVICE INFORMATION .....</b>	<b>44</b>

# TOWING EQUIPMENT

## SLINGBELT

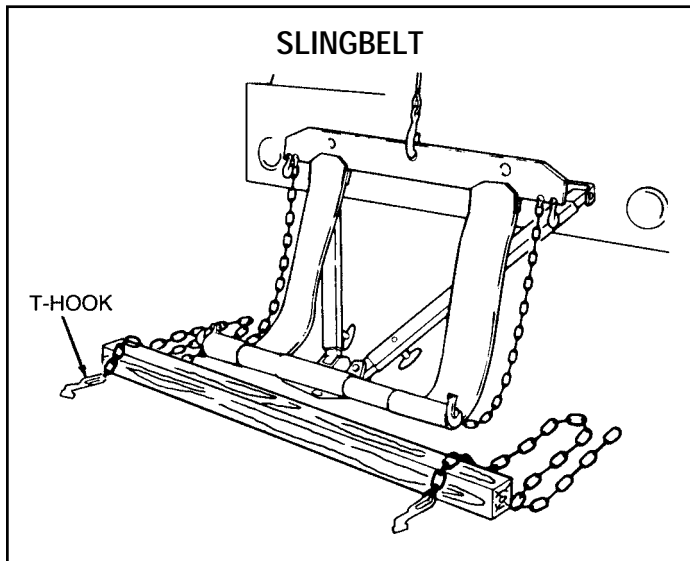

## CROSSBEAM/SPACER BLOCKS

### MATERIAL — CROSSBEAMS

ONE — 4 X 4 X 60" LONG — ONE 4 X 4 X 48" LONG

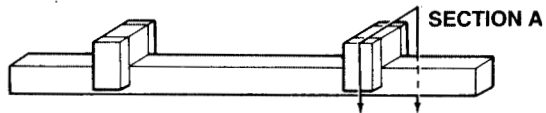

SPACER BLOCKS CAN BE  
FABRICATED AS SHOWN.

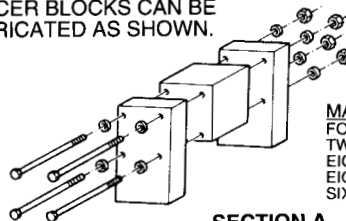

### MATERIAL-SPACER BLOCKS

FOUR — 2 x 4 x 6" LONG

TWO — 4 x 4 x 3-1/2" LONG

EIGHT — 1/4" x 7" CARRIAGE BOLT

EIGHT — 1/4" NUT

SIXTEEN — 1/4" WASHER

SECTION A

## CROSSBEAM/WITHOUT SPACER BLOCKS

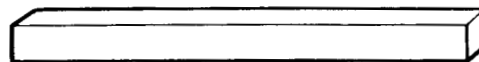

### MATERIAL — CROSSBEAMS

ONE — 4 X 4 X 60" LONG — ONE 4 X 4 X 48" LONG

# GENERAL TOWING INFORMATION — PASSENGER CARS

## IMPORTANT SAFETY NOTICE

### NOTES AND CAUTIONS

**As you read through the procedures, you will come across NOTES and CAUTIONS. Each one is there for a specific purpose. NOTES give you added information that will help to complete a particular procedure. CAUTIONS are given to prevent you from making an error that could damage the vehicle.**

### Preparatory Steps

Release the parking brake (see Lincoln LS for Electronic Parking Brake release procedure), and place transmission/transaxle in NEUTRAL. As a general rule, vehicles should be towed with the drive wheels off the ground. If the vehicle is to be towed on its drive wheels, the transmission/transaxle and differential must be operable. If the transmission/transaxle is not operable, place the drive wheels on a dolly or disconnect the rear driveshaft on rear wheel drive vehicles. **DO NOT** disconnect the driveshaft on Lincoln LS, Thunderbird or Mustang; refer to the caution in Lincoln LS, Thunderbird or Mustang portion of this manual. If the differential is not operable, place the drive wheels on a dolly.

When a vehicle is towed on its front wheels, the steering wheel must be clamped in the straight ahead position with a steering wheel clamping device designed for towing service use, such as those provided by towing system manufacturers.

Do not use the vehicle's steering column lock to lock the wheels in a straight ahead position when towed from the front or rear. If the ignition key is not available, place a dolly underneath the driving wheels of the vehicle and tow with the non-drive wheels raised.

### Brake-Shift Interlock

All Ford, Lincoln and Mercury vehicles, equipped with an automatic transmission/transaxle, incorporate a brake-shift interlock feature that prevents the gearshift lever from being moved from PARK when the ignition is in the ON position, unless the brake pedal is depressed. If you cannot move the gearshift lever out of PARK with the ignition in the ON position and the brake pedal depressed, refer to the automatic transmission or transaxle section in the driving section of the applicable Owner Guide.

### Flat Beds

When using a flatbed to transport a vehicle, always use T-hooks inserted in the appropriate tie down slot. Never fasten J-hooks to any suspension wheel or driveline component because J-hooks will damage these components. When using winches, take care to avoid damaging the bumper system, lower body panels, or air dams.

On vehicles equipped with an air suspension system, be sure the air suspension service switch is turned off prior to vehicle tie down.

**CAUTION: Improperly tying down a disabled vehicle may damage the vehicle's suspension, driveline or body parts.**

### Wheel Lift

**CAUTION: When towing over very rough or crowned intersection roads, the following special procedures are required when using any wheel lift equipment. The vehicle must be secured to the wheel lift equipment using safety chains equipped with T-hooks. If this procedure is not followed, damage to the underbody may result from excessive jounce travel of the suspension.**

# GENERAL TOWING INFORMATION — PASSENGER CARS

1. Attach the safety chain T-hook to the vehicle frame.
2. Run the chain through the hooks on the wheel lift crossbar and attach it to the towing vehicle, making sure there is no slack in the safety chain.
3. Repeat steps 1 and 2 for the other side of the vehicle.

## **Slingbelts**

Slingbelts may only be used when indicated in the towing procedure for a specific vehicle. When attaching slingbelts, take care to avoid damage to the license plate, fog lamps, etc., if equipped. Using a slingbelt when not indicated may cause damage to the bumper system, lower body panels, or air dams.

## **Towing Speeds**

See specific model instructions for vehicle towing speed and distance limitations.

UNLTD = Unlimited speed (50 mph/80 km/h) or mileage.

**On rough pavement, the maximum towing speed is 35 mph (55 km/h). Maximum towing speed of 35 mph (55 km/h) should be used whenever the tow truck operator is not sure of road surface condition.**

# WRECKER TOWING FORD VEHICLES WITH AIR BAGS

## General Information

An air bag is highly unlikely to deploy during wrecker towing. Standard wrecker towing or recovery procedures on an air bag equipped vehicle should not cause air bag deployment. Only a significant frontal or side (if equipped with side air bags) impact that closes two crash sensors will deploy an air bag.

## How to Determine if a Ford Vehicle has Air Bags

- The fourth position of all Ford passenger cars VINs is the letter:
  - “F” if equipped with active belts at all designated seating positions plus driver and passenger air bags.
  - “H” if equipped with active belts at all designated seating positions, driver and passenger air bags, plus driver and passenger side air bags, curtains, or canopies.
  - “B” if equipped with active belts at all designated seating positions – valid for F/CMVSS 500 low-speed vehicles only.
- The steering wheel hub will also be larger and more rectangular (about 6 inches x 9 inches). The passenger-side air bag module trim covers will be moulded with “SRS” or “AIR BAG”.

- The VIN plate may have “AIR BAG” printed on it.

## Is it Necessary to Disable the Air Bag System for Wrecker Towing?

- Disabling the air bag system is **not** necessary in most cases. But, as a precaution, disconnect the battery ground (-) cable in a safe manner.

**NOTE:** Turning the ignition switch to OFF may **not** disable the Ford air bag system. Some older model air bag deployment systems operate independently of the ignition key position.

## Wrecker Towing a Vehicle with Deployed Air Bags

- Deployed air bags are **not** dangerous.
- Any powdery residue consists of corn starch or talcum powder and sodium compounds, mostly sodium carbonates (e.g., baking soda) accompanied by very minute deposits of sodium hydroxide that can be irritating to the skin and eyes but poses no long term health hazard.

# ZX2

## FRONT TOWING CONNECTIONS

**CAUTION:** It is recommended that the ZX2 be towed with a wheel lift or flatbed equipment. Do not tow from the front with a slingbelt. Ford Motor Company has not approved a slingbelt towing procedure. If the vehicle is towed by other means or incorrectly, vehicle damage may occur.



**NOTE:** Refer to general towing information on pages 5 and 6 before towing vehicle.

TRANS	MPH/KMH	MILES/KMS
AUTO	UNLTD	UNLTD
MANUAL	UNLTD	UNLTD

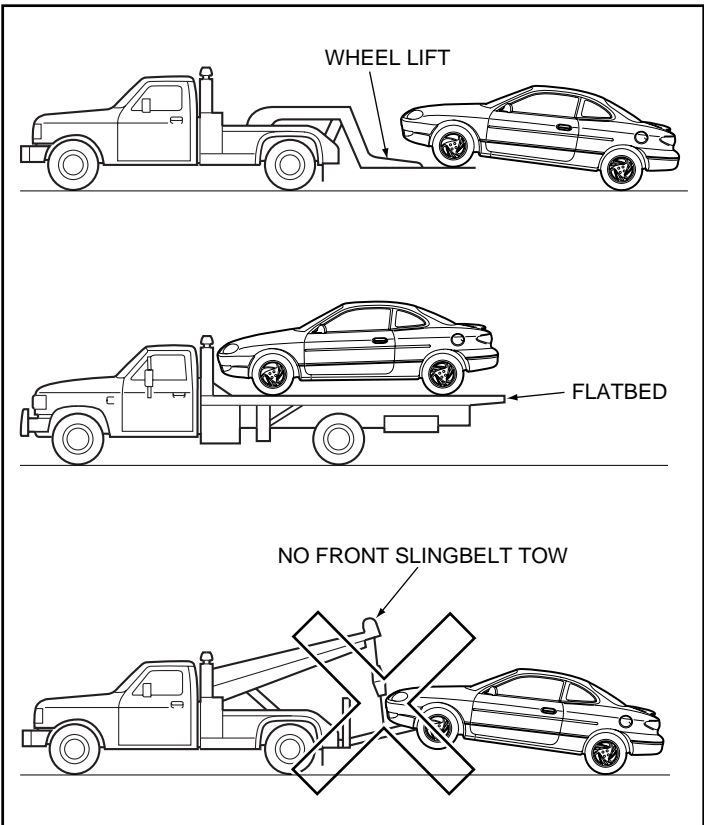





TRANS	MPH/KMH	MILES/KMS
AUTO	UNLTD	UNLTD
MANUAL	UNLTD	UNLTD

**ZX2**

## REAR TOWING CONNECTIONS

**CAUTION: Do not tow with J-hooks under any circumstances. J-hooks will damage driveline and suspension components.**



**CAUTION: If the vehicle is to be towed from the rear using wheel lift equipment, the front wheels (drive wheels) must be placed on a dolly to prevent damage to the transaxle.**

**CAUTION: It is recommended that the ZX2 be towed with a wheel lift or flatbed equipment. Do not tow from the rear with a slingbelt. Ford Motor Company has not approved a slingbelt towing procedure. If the vehicle is towed by other means or incorrectly, vehicle damage may occur.**

**NOTE: Refer to general towing information on pages 5 and 6 before towing vehicle.**

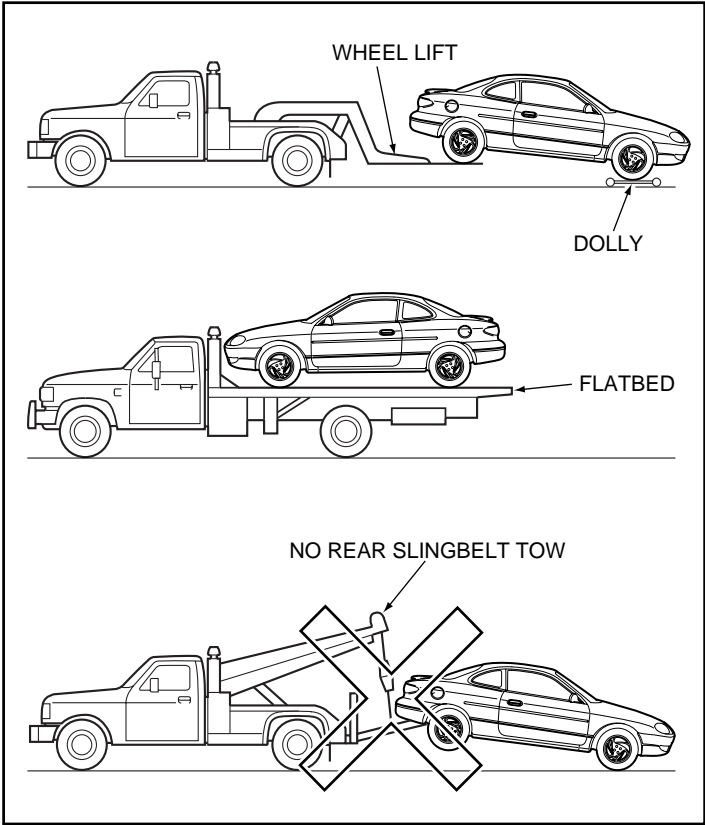

# TAURUS, SABLE

## FRONT TOWING CONNECTIONS

**CAUTION:** Do not tow with J-hooks under any circumstances. J-hooks will damage driveline and suspension components.



**CAUTION:** Use care not to damage fog lamps on vehicles, if equipped.

**CAUTION:** It is recommended that the Taurus, Sable be towed with a wheel lift or flatbed equipment. Do not tow with a slingbelt. Ford Motor Company has not approved a slingbelt towing procedure. If the vehicle is towed by other means or incorrectly, vehicle damage may occur.

**NOTE:** Refer to general towing information on pages 5 and 6 before towing vehicle.

TRANS	MPH/KMH	MILES/KMS
AUTO	35/56	50/80

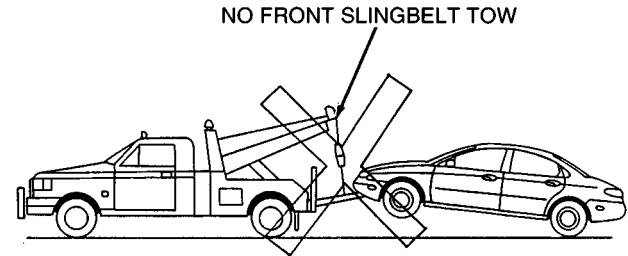
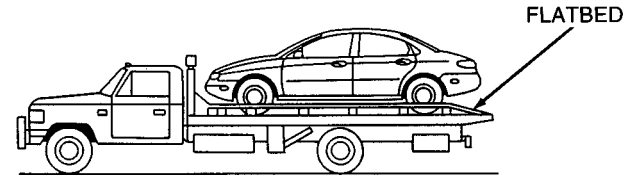
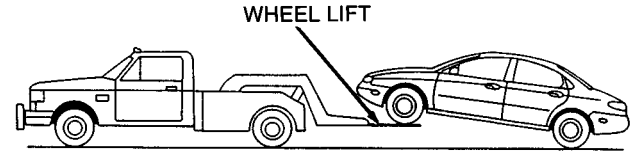



TRANS	MPH/KMH	MILES/KMS
AUTO	35/56	50/80

## TAURUS, SABLE

### REAR TOWING CONNECTIONS

**CAUTION:** Do not tow with J-hooks under any circumstances. J-hooks will damage lower control arms.



**CAUTION:** If the Taurus, Sable is to be towed from the rear using wheel lift equipment, it is recommended that the front wheels (drive wheels) be placed on a dolly to prevent damage to the transaxle.

**CAUTION:** Do not use shipping slots on bumper brackets for towing.

**CAUTION:** It is recommended that the Taurus, Sable be towed with a wheel lift or flatbed equipment. Do not tow with a slingbelt. Ford Motor Company has not approved a slingbelt towing procedure. If the vehicle is towed by other means or incorrectly, vehicle damage may occur.

**NOTE:** Refer to general towing information on pages 5 and 6 before towing vehicle.

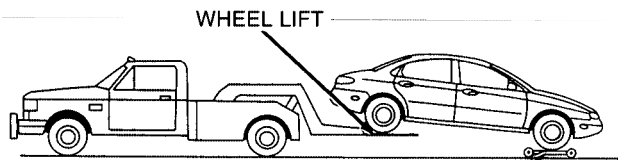

DOLLY

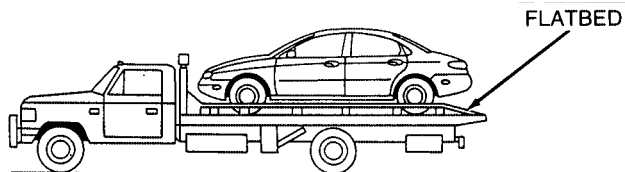

NO REAR SLINGBELT TOW

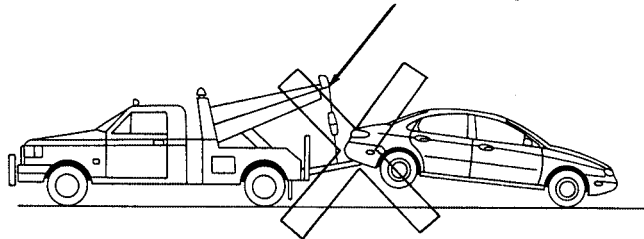

# MUSTANG

## FRONT TOWING CONNECTIONS

**CAUTION:** Do not tow from the front with T-hooks or J-hooks under any circumstances.

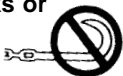

**CAUTION:** Do not disconnect the driveshaft since the system is aligned and balanced.

**CAUTION:** It is recommended that the Mustang be towed with flatbed equipment only. Do not tow with a slingbelt or wheel lift. Ford Motor Company has not approved a slingbelt or wheel lift towing procedure. If the vehicle is towed by other means or incorrectly, vehicle damage may occur.

**CAUTION:** Cobra and Mach 1 vehicles must be towed with flatbed equipment only. 4x4 blocks must be placed under the end of the inclined ramp to allow for bumper clearance. Failure to use 4x4 blocks may result in damage to the front fascia.

**CAUTION:** It is recommended that the vehicle be pulled onto a flatbed tow truck with the tow hook attached to a canvas strap, to prevent damage to the bottom of the front or rear bumper covers. If a strap is not available, wrap the tow cable/chain with a cloth.

**NOTE:** Refer to general towing information on pages 5 and 6 before towing vehicle.

TRANS	MPH/KMH	MILES/KMS
AUTO	35/55	50/80
MANUAL	35/55	UNLTD

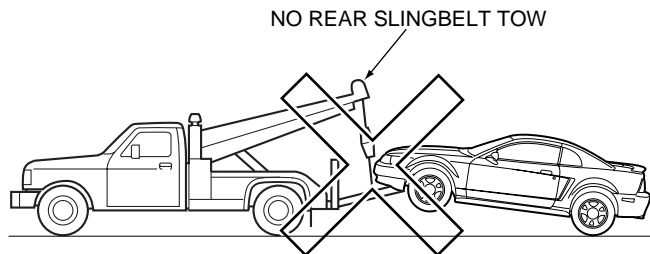
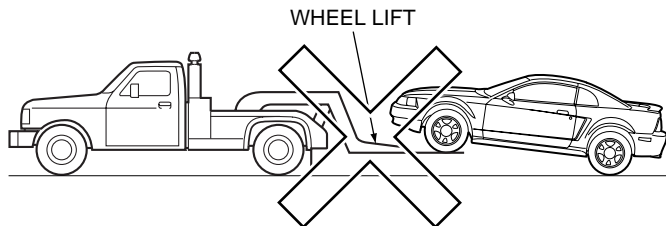
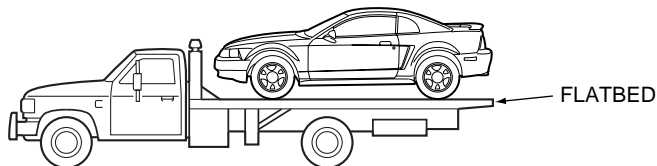



TRANS	MPH/KMH	MILES/KMS
AUTO	UNLTD	UNLTD
MANUAL	UNLTD	UNLTD

# MUSTANG

## REAR TOWING CONNECTIONS

**CAUTION:** Do not tow with T-hooks or J-hooks under any circumstances. J-hooks will damage drive-line and suspension components. 

**CAUTION:** Do not disconnect the driveshaft since the system is aligned and balanced.

**CAUTION:** It is recommended that the Mustang be towed with flatbed equipment only. Do not tow with a slingbelt or wheel lift. Ford Motor Company has not approved a slingbelt or wheel lift towing procedure. If the vehicle is towed by other means or incorrectly, vehicle damage may occur.

**CAUTION:** Cobra and Mach 1 vehicles must be towed with flatbed equipment only. 4x4 blocks must be placed under the end of the inclined ramp to allow for bumper clearance. Failure to use 4x4 blocks may result in damage to the front fascia.

**CAUTION:** It is recommended that the vehicle be pulled onto a flatbed tow truck with the tow hook attached to a canvas strap, to prevent damage to the bottom of the front or rear bumper covers. If a strap is not available, wrap the tow cable/chain with a cloth.

**NOTE:** Refer to general towing information on pages 5 and 6 before towing vehicle.

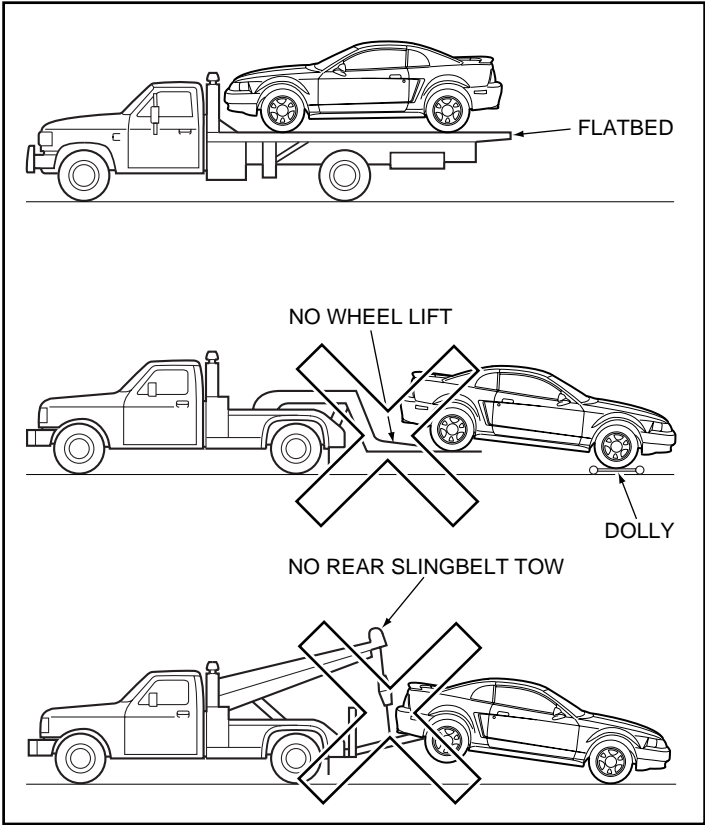

## TOWN CAR, CROWN VICTORIA, GRAND MARQUIS

### FRONT TOWING CONNECTIONS

**CAUTION:** Do not tow with J-hooks under any circumstances. J-hooks will damage driveline and suspension components.



**CAUTION:** Before the vehicle can be towed, the air suspension control in the luggage compartment must be turned to the OFF position (if equipped).

**CAUTION:** It is recommended that the Town Car, Crown Victoria and Grand Marquis be towed with a wheel lift or flatbed equipment. Do not tow with a slingbelt. Ford Motor Company has not approved a slingbelt towing procedure. If the vehicle is towed by other means or incorrectly, vehicle damage may occur.

**NOTE:** Refer to general towing information on pages 5 and 6 before towing vehicle.

TRANS	MPH/KMH	MILES/KMS
AUTO	35/55	50/80

RWD

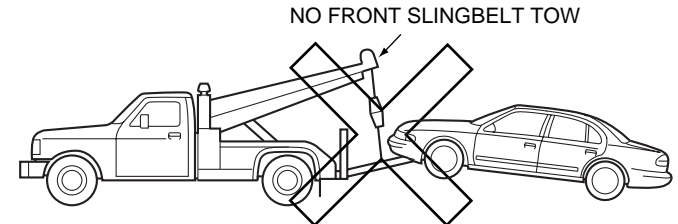
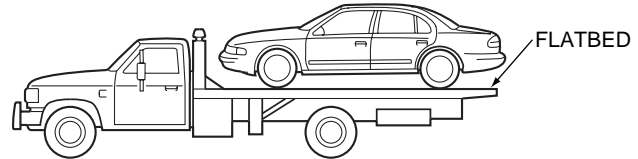
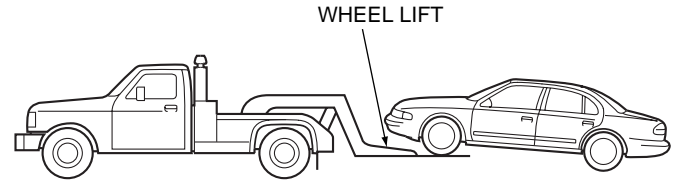



TRANS	MPH/KMH	MILES/KMS
AUTO	UNLTD	UNLTD

## TOWN CAR, CROWN VICTORIA, GRAND MARQUIS

### REAR TOWING CONNECTIONS

**CAUTION:** Do not tow with J-hooks under any circumstances. J-hooks will damage driveline and suspension components.



**CAUTION:** Before the vehicle can be towed, the air suspension control in the luggage compartment must be turned to the OFF position (if equipped).

**CAUTION:** It is recommended that the Town Car, Crown Victoria and Grand Marquis be towed with a wheel lift or flatbed equipment. Do not tow with a slingbelt. Ford Motor Company has not approved a slingbelt towing procedure. If the vehicle is towed by other means or incorrectly, vehicle damage may occur.

**NOTE:** Refer to general towing information on pages 5 and 6 before towing vehicle.

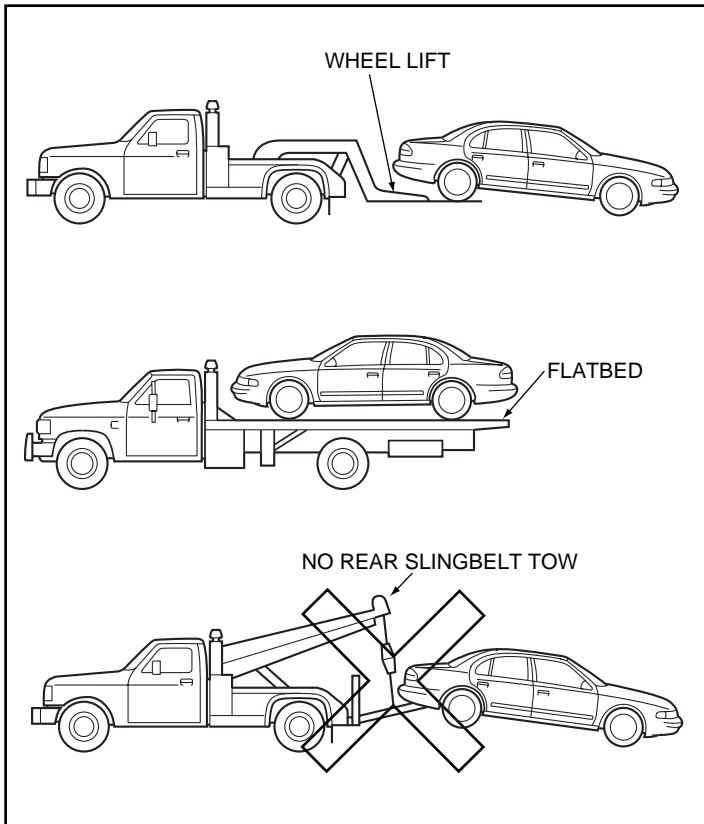

# FOCUS

## FRONT TOWING CONNECTIONS

**CAUTION:** It is recommended that the Focus be towed with a wheel lift or flatbed equipment. Do not tow with a slingbelt. Ford Motor Company has not approved a slingbelt towing procedure. If the vehicle is towed from the front by other means or incorrectly, vehicle damage may occur.



**CAUTION:** If the brake-shift interlock is not deactivated, the tires cannot roll. If you cannot move the gearshift lever from P (Park) with the brake pedal depressed, proceed as follows:

1. Turn the ignition off and remove the ignition key.
2. Apply the parking brake and the brake pedal.
3. Insert a screwdriver or similar tool about 5 cm (2 inches) into the square opening to the right of the gearshift, at the base of the console.
4. Rotate the screwdriver point rearward.
5. Push and hold the thumb button and move the gearshift.
6. Remove the screwdriver when the gearshift moves from the P (Park) position.

The console-mounted gearshift will lock when you turn the key to the lock position. When the gearshift is in any position except P (Park), the ignition key cannot be removed from the steering column. To remove the key, the gearshift lever must be in P (Park).

**NOTE:** Refer to general towing information on pages 5 and 6 before towing vehicle.

TRANS	MPH/KMH	MILES/KMS
AUTO	UNLTD	UNLTD
MANUAL	UNLTD	UNLTD

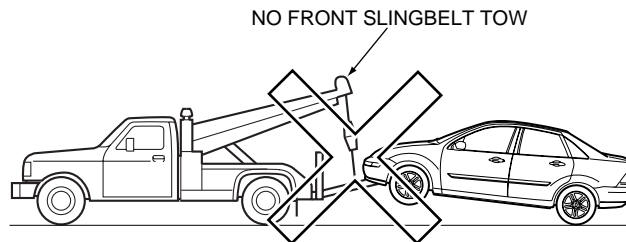
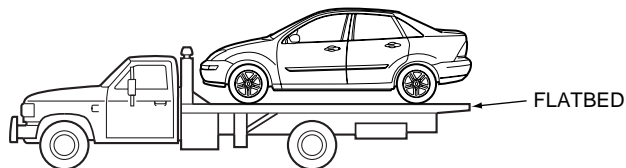
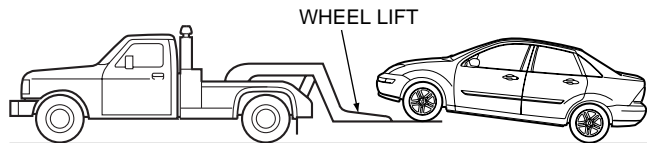





TRANS	MPH/KMH	MILES/KMS
AUTO	UNLTD	UNLTD
MANUAL	UNLTD	UNLTD

# FOCUS

## REAR TOWING CONNECTIONS

**CAUTION: Do not tow with J-hooks under any circumstances. J-hooks will damage driveline and suspension components.**



**CAUTION: If the vehicle is to be towed from the rear, using wheel lift equipment, the front wheels (drive wheels) must be placed on a dolly to prevent damage to the transaxle.**

**CAUTION: It is recommended that the Focus be towed with a wheel lift or flatbed equipment. Do not tow with a slingbelt. Ford Motor Company has not approved a slingbelt towing procedure.**

**If the vehicle is towed by other means or incorrectly, vehicle damage may occur.**

**NOTE: Refer to general towing information on pages 5 and 6 before towing vehicle.**

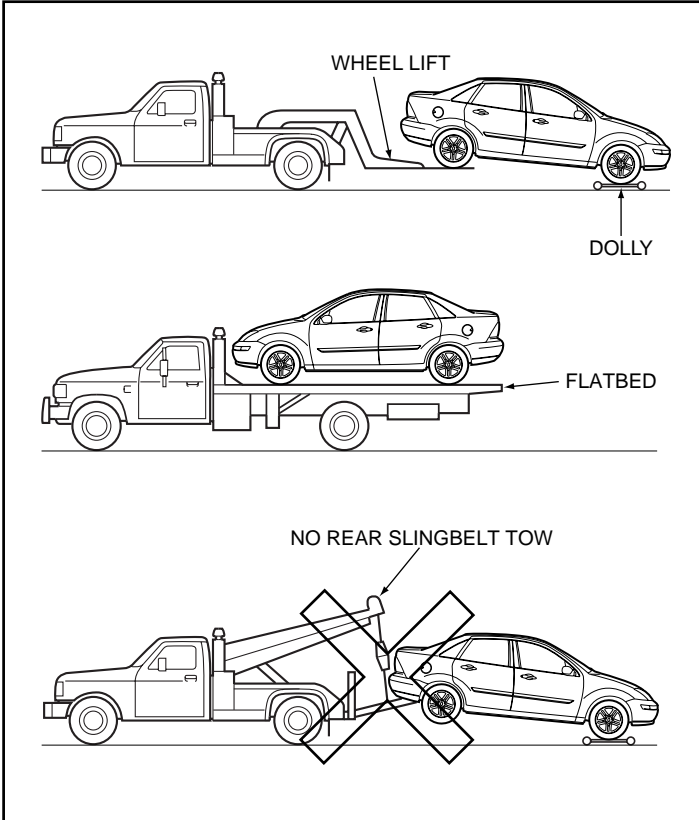

# LINCOLN LS

## FRONT TOWING CONNECTIONS

**CAUTION:** Do not tow with J-hooks under any circumstances. J-hooks may damage driveline or suspension components.

**CAUTION:** Do not disconnect the driveshaft since the system is aligned and balanced.



**CAUTION:** It is recommended that the Lincoln LS be towed with a wheel lift or flatbed equipment. Do not tow with a slingbelt. Ford Motor Company has not approved a slingbelt towing procedure. If the vehicle is towed by other means or incorrectly, vehicle damage may occur.

**CAUTION:** It is recommended that the vehicle be pulled onto a flatbed tow truck with the tow hook attached to a canvas strap, to prevent damage to the bottom of the front or rear bumper covers. If a strap is not available, wrap the tow cable/chain with a cloth.

**NOTE:** Refer to general towing information on pages 5 and 6 before towing vehicle.

### LS Electronic Parking Brake

To release the Electronic Parking Brake (EPB) on the vehicle with no battery power, perform the following steps.

1. Connect jumper cables as normal (battery access is in the trunk).
2. Turn the ignition key to the ON position.
3. Depress and hold the brake pedal, and then shift the transmission out of PARK.
  - The EPB will be released, but the system will need to be recalibrated. This procedure can be performed once the vehicle reaches its destination.

To release the EPB on a vehicle with battery power, perform the following steps.

1. Turn the ignition key to the ON position.
2. Depress and hold the brake pedal.
3. Push the EPB switch down.

TRANS	MPH/KMH	MILES/KMS
AUTO	35/55	50/80

RWD

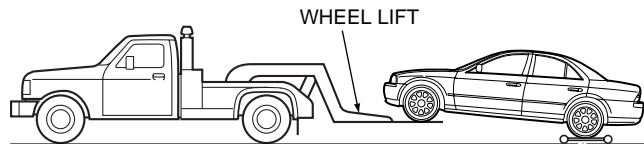

DOLLY

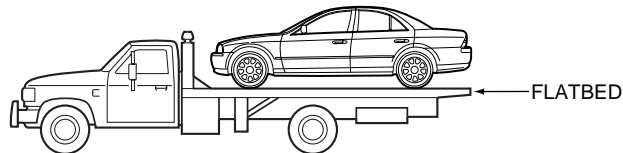

NO FRONT SLINGBELT TOW

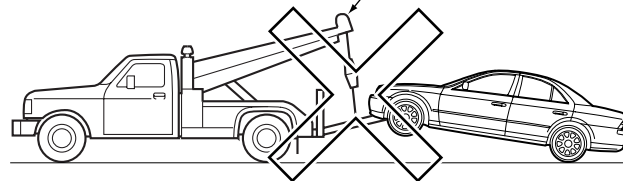



TRANS	MPH/KMH	MILES/KMS
AUTO	UNLTD	UNLTD

## LINCOLN LS

### REAR TOWING CONNECTIONS

**CAUTION:** Do not tow with J-hooks under any circumstances. J-hooks will damage driveline and suspension components.



**CAUTION:** Do not disconnect the driveshaft since the system is aligned and balanced.

**CAUTION:** It is recommended that the Lincoln LS be towed with a wheel lift or flatbed equipment. Do not tow with a slingbelt. Ford Motor Company has not approved a slingbelt towing procedure. If the vehicle is towed by other means or incorrectly, vehicle damage may occur.

**CAUTION:** It is recommended that the vehicle be pulled onto a flatbed tow truck with the tow hook attached to a canvas strap, to prevent damage to the bottom of the front or rear bumper covers. If a strap is not available, wrap the tow cable/chain with a cloth.

**NOTE:** Refer to general towing information on pages 5 and 6 before towing vehicle.

#### LS Electronic Parking Brake

To release the Electronic Parking Brake (EPB) on the vehicle with no battery power, perform the following steps.

1. Connect jumper cables as normal (battery access is in the trunk).
2. Turn the ignition key to the ON position.
3. Depress and hold the brake pedal, and then shift the transmission out of PARK.
  - The EPB will be released, but the system will need to be recalibrated. This procedure can be performed once the vehicle reaches its destination.

To release the EPB on a vehicle with battery power, perform the following steps.

1. Turn the ignition key to the ON position.
2. Depress and hold the brake pedal.
3. Push the EPB switch down.

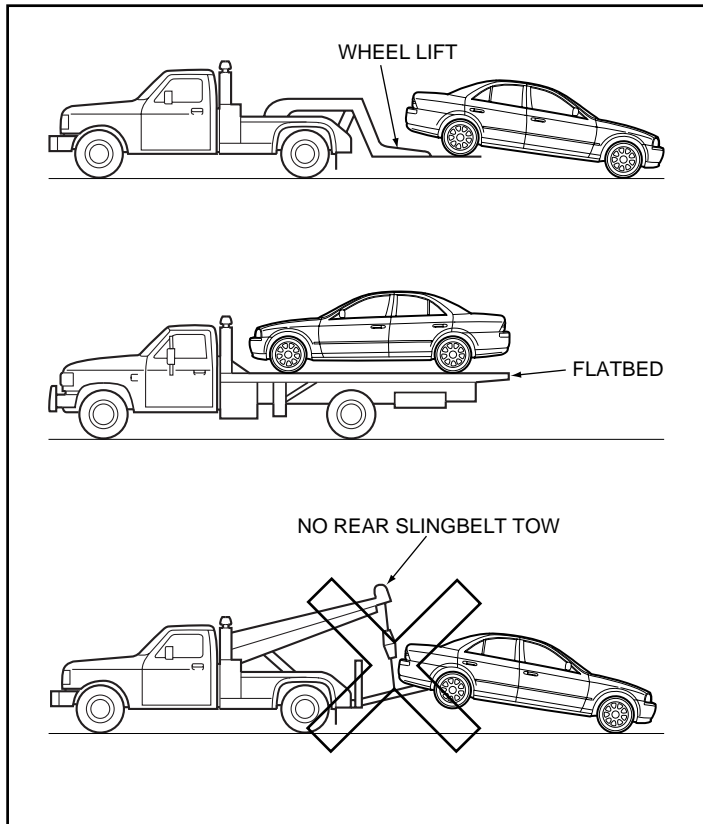

# THUNDERBIRD

## FRONT TOWING CONNECTIONS

**CAUTION:** Do not tow with J-hooks under any circumstances. J-hooks may damage driveline or suspension components.



**CAUTION:** Do not disconnect the driveshaft since the system is aligned and balanced.

**CAUTION:** It is recommended that the Thunderbird be towed with a wheel lift or flatbed equipment. Do not tow with a slingbelt. Ford Motor Company has not approved a slingbelt towing procedure. If the vehicle is towed by other means or incorrectly, vehicle damage may occur.

**CAUTION:** It is recommended that the vehicle be pulled onto a flatbed tow truck with the tow hook attached to a canvas strap, to prevent damage to the bottom of the front or rear bumper covers. If a strap is not available, wrap the tow cable/chain with a cloth.

**NOTE:** Refer to general towing information on pages 5 and 6 before towing vehicle.

TRANS	MPH/KMH	MILES/KMS
AUTO	35/55	50/80

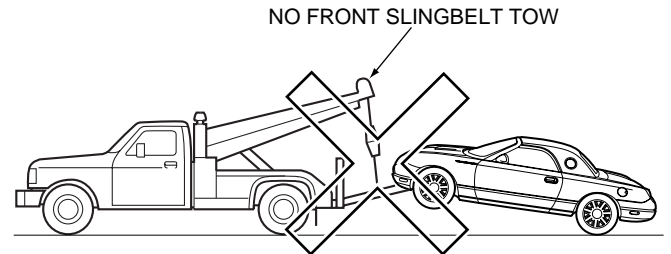
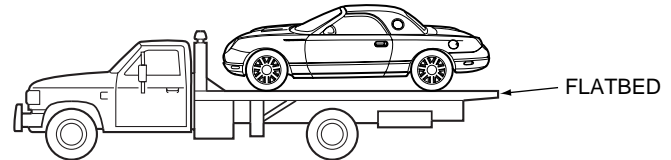
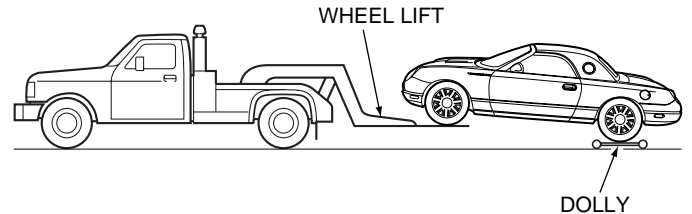



TRANS	MPH/KMH	MILES/KMS
AUTO	UNLTD	UNLTD

# THUNDERBIRD

## REAR TOWING CONNECTIONS

**CAUTION:** Do not tow with J-hooks under any circumstances. J-hooks will damage driveline and suspension components.



**CAUTION:** Do not disconnect the driveshaft since the system is aligned and balanced.

**CAUTION:** It is recommended that the Thunderbird be towed with a wheel lift or flatbed equipment. Do not tow with a slingbelt. Ford Motor Company has not approved a slingbelt towing procedure. If the vehicle is towed by other means or incorrectly, vehicle damage may occur.

**CAUTION:** It is recommended that the vehicle be pulled onto a flatbed tow truck with the tow hook attached to a canvas strap, to prevent damage to the bottom of the front or rear bumper covers. If a strap is not available, wrap the tow cable/chain with a cloth.

**NOTE:** Refer to general towing information on pages 5 and 6 before towing vehicle.

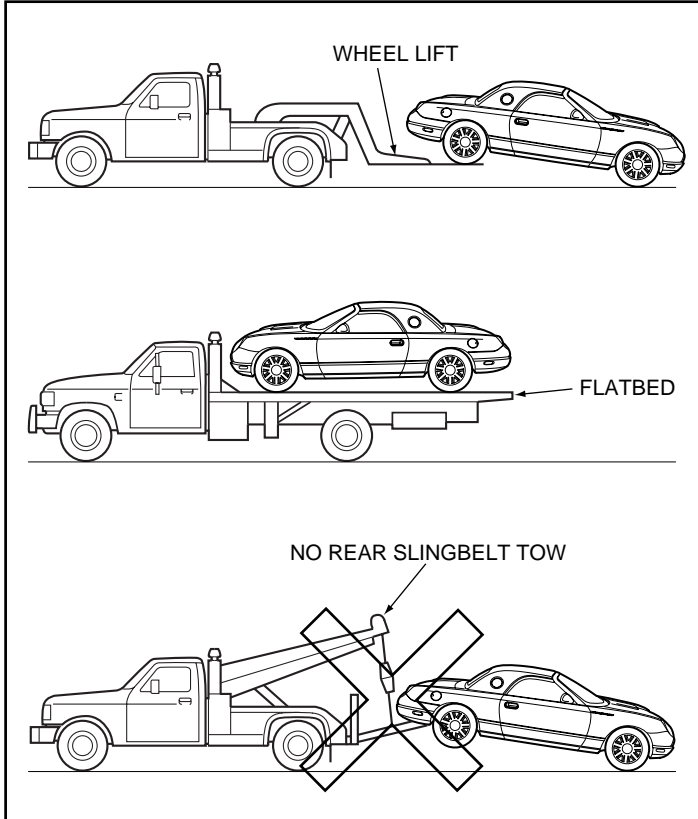

# GENERAL TOWING INFORMATION — LIGHT TRUCKS

## IMPORTANT SAFETY NOTICE

### NOTES AND CAUTIONS

As you read through the procedures, you will come across **NOTES** and **CAUTIONS**. Each one is there for a specific purpose. **NOTES** give you added information that will help to complete a particular procedure. **CAUTIONS** are given to prevent you from making an error that could damage the vehicle.

### Preparatory Steps

Release the parking brake and place the transmission/transaxle in NEUTRAL. As a general rule, vehicles should be towed with the drive wheels off the ground. If the vehicle is to be towed on its drive wheels, the transmission/transaxle and differential must be operable. If the transmission/transaxle is not operable, place the drive wheels on a dolly or disconnect the rear driveshaft (on rear wheel drive vehicles). If the differential is not operable, place the drive wheels on a dolly.

When a vehicle is towed on its front wheels, the steering wheel must be clamped in the straight ahead position with a steering wheel clamping device designed for towing service use, such as those provided by towing system manufacturers.

Do not use the vehicle's steering column lock to lock the wheels in a straight ahead position when pulled from the rear. If the ignition key is not available, place a dolly underneath the drive wheels of the vehicle and tow with the non-drive wheels raised.

### Brake-Shift Interlock

All Ford, Lincoln and Mercury vehicles, equipped with an automatic transmission/transaxle, incorporate a brake-shift interlock feature that prevents the gearshift lever from being moved from PARK when the ignition is in the ON position, unless the brake pedal is depressed. If you cannot move the gearshift lever out of PARK with the ignition in the ON position and the brake pedal depressed, refer to the automatic transmission or transaxle section in the driving section of the applicable Owner Guide.

**WARNING: DO NOT TOW VEHICLE BACKWARD WHEN TOWING THE VEHICLE WITH ALL FOUR WHEELS ON THE GROUND.**

When towing the vehicle with all four wheels on the ground, the steering wheel should be left unlocked.

**CAUTION: Improper towing of the vehicle could result in transmission/transaxle and/or transfer case damage. Always follow the outlined towing procedures. It is recommended that only an unloaded vehicle be towed.**

**IF TOWING WITH A LOAD IS UNAVOIDABLE, CARE MUST BE TAKEN TO PROPERLY RESTRAIN LOAD FROM SHIFTING AND DISTRIBUTE THE LOAD EVENLY IN THE PICKUP BOX.**



## GENERAL TOWING INFORMATION — LIGHT TRUCKS

### Towing Four-Wheel Drive Vehicles with Lever-Operated Transfer Case – F-250 through F-550 and Excursion

1. Place the transmission/transaxle (automatic or manual) in N (NEUTRAL).
2. Place the transfer case in N (NEUTRAL).

**NOTE:** The transfer case NEUTRAL setting is located between 4H and 4L. In order to place the transfer case in NEUTRAL, the lever must be moved slightly to the left and rearward of the 4H position. With the ignition in the ON position, both the 4x4 and LOW RANGE indicator lights will be off when the transfer case is in NEUTRAL.

3. Set the manual locking hubs in AUTO or FREE position.

**NOTE:** Place the locking hub into the AUTO or FREE position. To verify the system is in the NEUTRAL position, the front driveshaft should turn freely.

Vehicle speed should not exceed 55 mph (90 km/h). This applies with either the front or rear wheels off the ground, or both front and rear wheels on the ground.

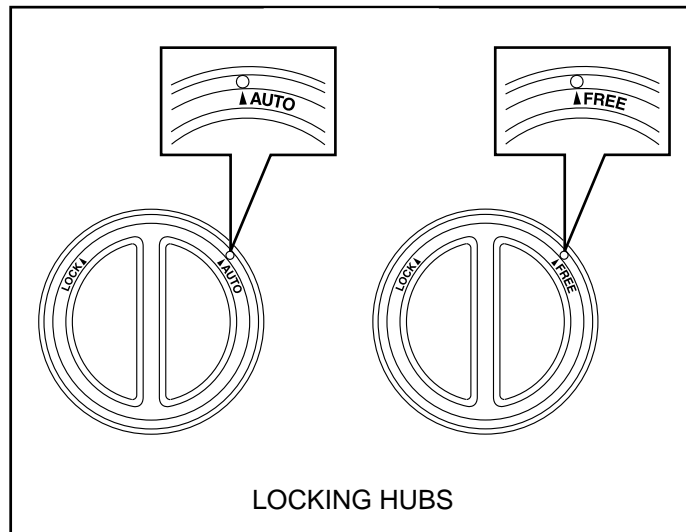

# GENERAL TOWING INFORMATION — LIGHT TRUCKS

## Towing Four-Wheel Drive Vehicles with Electronic Shift Transfer Case

1. Place the transmission (automatic or manual) in N (NEUTRAL).
2. Place the transfer case in 2H (HIGH).

NOTE: Both the 4x4 and LOW RANGE indicator lights will be off when the transfer case is in 2H (HIGH).

3. Disengage the locking hubs (automatic or manual). Refer to the illustration on the previous page.

Once these three conditions are met, follow instructions for towing two-wheel drive vehicles.

Towing speed is limited to 35 mph (55 km/h) and 50 miles (80 km) with the drive wheels on the ground.

**WARNING: NEVER USE A TOW BAR THAT ATTACHES TO THE BUMPER WHEN TOWING THE VEHICLE. THE BUMPER COULD BE DAMAGED AND CAUSE AN ACCIDENT.**

NOTE: If a distance of 50 miles (80 km) and/or a speed of 35 mph (55 km/h) is exceeded, either position dollies under the rolling wheels, or disconnect the driveshaft of the rolling axle(s). Towing speed should not exceed 50 mph (80 km/h).

## Flat Beds

**CAUTION: Improperly tying down a disabled vehicle may damage the vehicle's suspension, driveline or body parts.**

## Wheel Lift

**CAUTION: When towing over very rough or crowned intersection roads, the following special procedures are required when using any wheel lift equipment. The vehicle must be secured to the wheel lift equipment using safety chains equipped with T-hooks.**

**If this procedure is not followed, damage to the underbody may result from excessive jounce travel of the suspension.**

1. Attach the safety chain T-hook to the vehicle frame.
2. Run the chain through the hooks on the wheel lift crossbar and attach it to the towing vehicle, making sure there is no slack in the safety chain.
3. Repeat steps 1 and 2 for the other side of the vehicle.

## Slingbelts/Chains/Hooks

Slingbelts may only be used when indicated in the towing procedure for a specific vehicle. When attaching slingbelts, take care to avoid damage to the license plate, fog lamps, etc., if equipped. Using a slingbelt when not indicated may cause damage to the bumper system, lower body panels, or air dams.

**CAUTION: Use caution when attaching tow hooks and safety chains to vehicle. Position and remove hooks with care to avoid damage to brake hoses, brake lines and steering linkage components.**

NOTE: On vehicles equipped with bumper guards, make sure the slingbelt towbar is under the bumper and the weight of the vehicle is not supported by the bumper guards.

## Towing Speeds

See specific model instructions for vehicle towing speed and distance limitations.

UNLTD = Unlimited speed (50 mph/80 km/h) or mileage.

**On rough pavement, the maximum towing speed is 35 mph (55 km/h). Maximum towing speed of 35 mph (55 km/h) should be used whenever the tow truck operator is not sure of road surface conditions.**



# WRECKER TOWING FORD VEHICLES WITH AIR BAGS

## General Information

An air bag is highly unlikely to deploy during wrecker towing. Standard wrecker towing or recovery procedures on an air bag equipped vehicle should not cause air bag deployment. Only a significant frontal impact that closes two crash sensors will deploy an air bag.

## How to Determine if a Ford Vehicle has Air Bags

- The fourth position of all Ford light truck VINs is the letter:
  - "A, N, P, R, S, T, U, V, W, X, Y, or Z" if equipped with driver and passenger air bags.
  - "B, C, D, E, or F" if equipped with driver and passenger air bags, plus driver and passenger side air bags, curtains, or canopies.
  - "G, H, J, K, L, or M" if **not** equipped with air bags.
- The steering wheel hub will also be larger and more rectangular (about 6 inches x 9 inches). The passenger-side air bag module trim covers will be moulded with "SRS".

## Is it Necessary to Disable the Air Bag System for Wrecker Towing?

- Disabling the air bag system is **not** necessary in most cases.
- As a precaution, disconnect the battery in a safe manner, when the vehicle has significant damage to the front of the vehicle and an undeployed air bag.

**NOTE:** Turning the ignition switch to OFF will **not** disable the Ford air bag system. The air bag deployment system operates independently of the ignition key position.

## Wrecker Towing a Vehicle with Deployed Air Bags

- Deployed air bags are **not** dangerous.
- Any powdery residue consists of corn starch or talcum powder and sodium compounds, mostly sodium carbonates (e.g., baking soda) accompanied by very minute deposits of sodium hydroxide that can be irritating to the skin and eyes but poses no long term health hazard.

# WINDSTAR

## FRONT TOWING CONNECTIONS — SLINGBELT

**CAUTION: Do not tow with J-hooks under any circumstances. J-hooks will damage driveline and suspension components.**



**CAUTION: It is recommended that the Windstar be towed with a wheel lift or flatbed equipment. However, a slingbelt with T-hooks can also be used. If the vehicle is towed by other means or incorrectly, vehicle damage may occur.**

**NOTE: Refer to general towing information on pages 22 through 24 before towing vehicle.**

- Insert T-hooks in T-hook slots on the bottom of the frame rail.
- Place a 4x4 under front bumper and against the air dam.
- Position towbar against 4x4.
- Attach safety chains around stabilizer bar at the insulators.

TRANS	MPH/KMH	MILES/KMS
AUTO	UNLTD	UNLTD

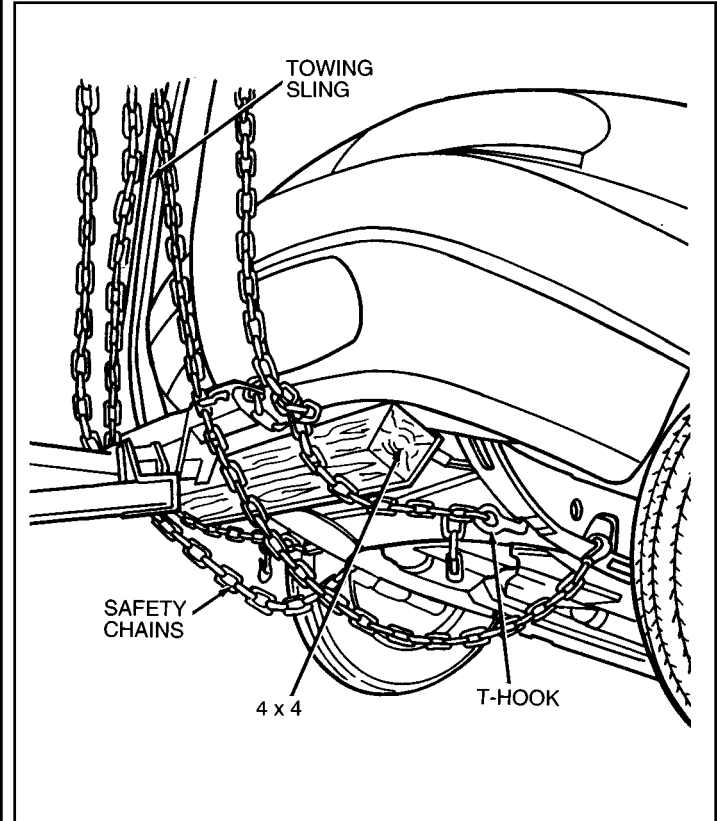

## REAR TOWING CONNECTIONS — SLINGBELT

**CAUTION: Do not tow with J-hooks under any circumstances. J-hooks will damage driveline and suspension components.**



**CAUTION: If the Windstar is to be towed from the rear using wheel lift or slingbelt equipment, the front wheels (drive wheels) must be placed on a dolly to prevent damage to the transaxle.**

**CAUTION: It is recommended that the Windstar be towed with a wheel lift or flatbed equipment. However, a slingbelt with T-hooks can also be used. If the vehicle is towed by other means or incorrectly, vehicle damage may occur.**

**NOTE: Refer to general towing information on pages 22 through 24 before towing vehicle.**

- Insert T-hooks in T-hook slots at bottom of frame rail.
- Place spacer blocks and 4x4 crossbeam behind bumper and across frame rails. Make sure that spacer blocks are under frame rails.
- Place towbar against 4x4.
- Attach safety chains around rear axle inboard of coil springs.

TRANS	MPH/KMH	MILES/KMS
AUTO	35/55	50/80

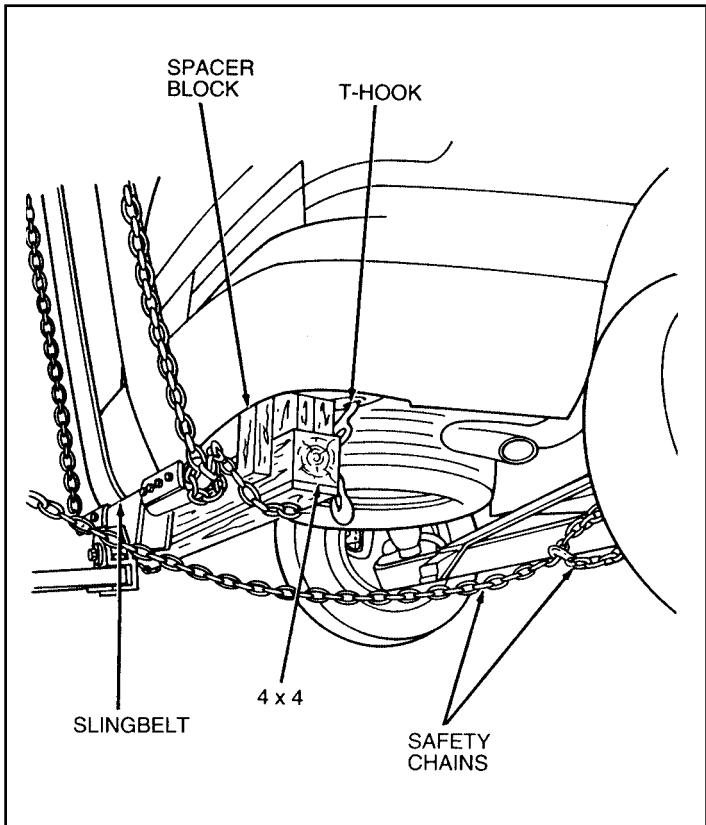

# WINDSTAR

## FRONT AND REAR TOWING CONNECTIONS

**CAUTION:** Do not tow with J-hooks under any circumstances. J-hooks will damage driveline and suspension components.



**CAUTION:** If the Windstar is to be towed from the rear using wheel lift or slingbelt equipment, the front wheels (drive wheels) must be placed on a dolly to prevent damage to the transaxle.

**CAUTION:** It is recommended that the Windstar be towed with a wheel lift or flatbed equipment. However, a slingbelt with T-hooks can also be used. If the vehicle is towed by other means or incorrectly, vehicle damage may occur.

**NOTE:** Refer to general towing information on pages 22 through 24 before towing vehicle.

TRANS	MPH/KMH	MILES/KMS
AUTO	35/55	50/80

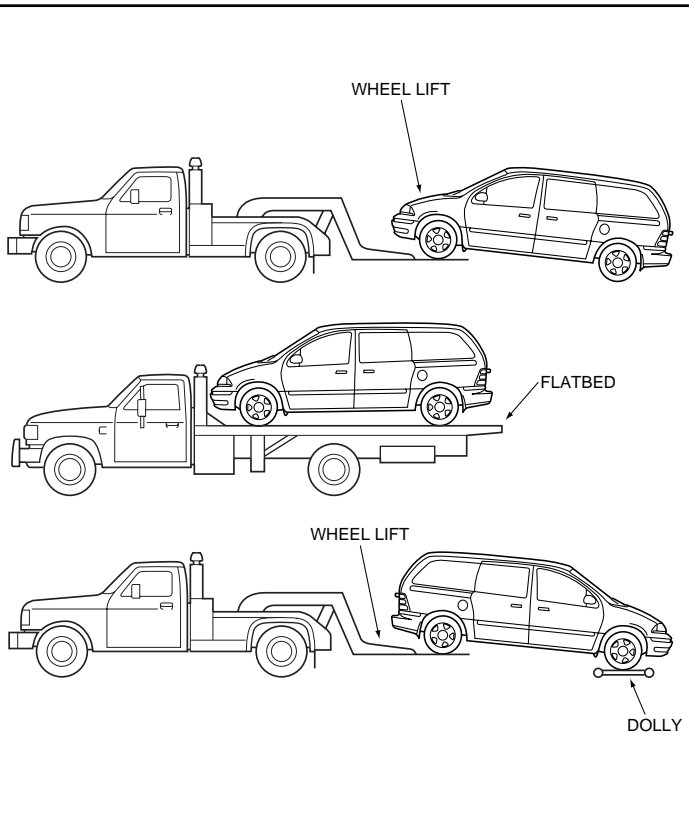



TRANS	MPH/KMH	MILES/KMS
AUTO	35/55	50/80
MANUAL	35/55	UNLTD

## AVIATOR, EXPLORER, MOUNTAINEER (4x2) (4x4)

### FRONT TOWING CONNECTIONS

**CAUTION:** Do not tow with J-hooks under any circumstances. J-hooks will damage driveline and suspension components.



**CAUTION:** It is recommended that the Aviator, Explorer, Mountaineer (4x2) (4x4) be towed with a wheel lift or flatbed equipment. Do not tow with a slingbelt. Ford Motor Company has not approved a slingbelt towing procedure.

**NOTE:** Refer to general towing information on pages 22 through 24 before towing vehicle.

**NOTE:** On a 4x4 vehicle, it is recommended that the vehicle be towed with a wheel lift or flatbed equipment with all the wheels off the ground.

**If the vehicle is towed by other means or incorrectly, vehicle damage may occur.**

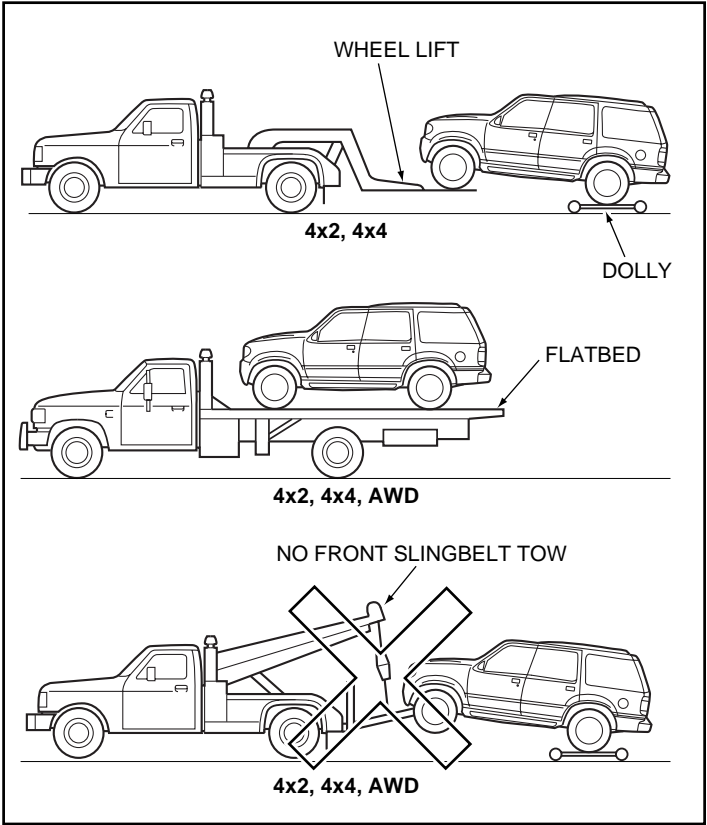

## AVIATOR, EXPLORER, MOUNTAINEER (4x2) (4x4)

### REAR TOWING CONNECTIONS

**CAUTION: Do not tow with J-hooks under any circumstances. J-hooks will damage driveline and suspension components.**



**CAUTION: It is recommended that the Aviator, Explorer, Mountaineer (4x2) (4x4) be towed with a wheel lift or flatbed equipment. Do not tow with a slingbelt. Ford Motor Company has not approved a slingbelt towing procedure.**

**NOTE:** Refer to general towing information on pages 22 through 24 before towing vehicle.

**NOTE:** On a 4x2 vehicle, it is acceptable to tow the vehicle with the front wheels on the ground (without dollies) and the rear wheels off the ground.

**NOTE:** On a 4x4 vehicle, it is recommended that the vehicle be towed with a wheel lift or flatbed equipment with all the wheels off the ground.

**If the vehicle is towed by other means or incorrectly, vehicle damage may occur.**

TRANS	MPH/KMH	MILES/KMS
AUTO	35/55	50/80
MANUAL	35/55	UNLTD

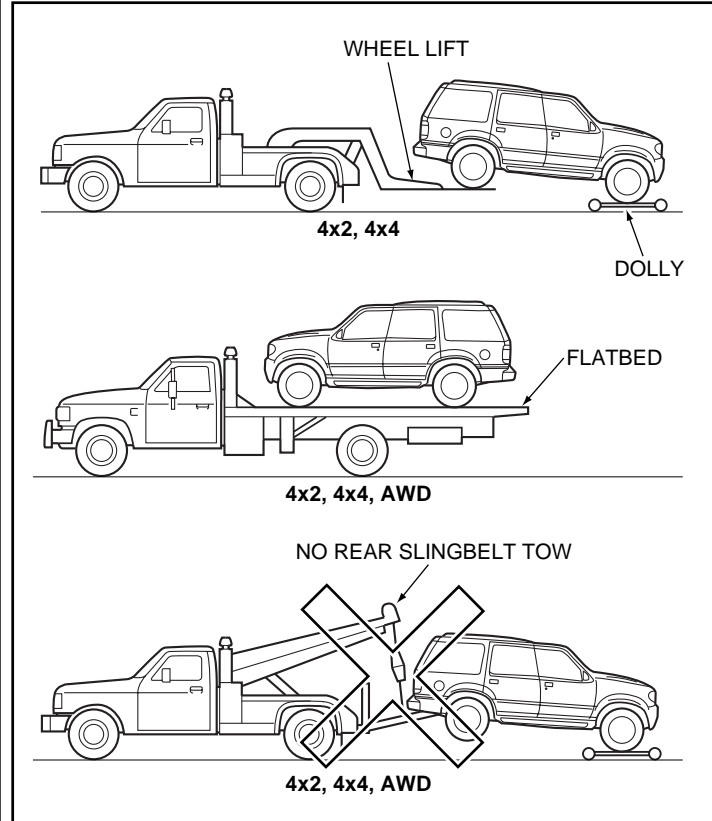



TRANS	MPH/KMH	MILES/KMS
AUTO	35/55	50/80
MANUAL	35/55	UNLTD

## SPORT, SPORT-TRAC (4x2) (4x4)

### FRONT TOWING CONNECTIONS

**CAUTION:** Do not tow with J-hooks under any circumstances. J-hooks will damage driveline and suspension components.



**CAUTION:** It is recommended that the Sport, Sport-Trac (4x2) (4x4) be towed with a wheel lift or flatbed equipment. Do not tow with a slingbelt. Ford Motor Company has not approved a slingbelt towing procedure.

**NOTE:** Refer to general towing information on pages 22 through 24 before towing vehicle.

**NOTE:** On a 4x4 vehicle, it is recommended that the vehicle be towed with a wheel lift or flatbed equipment with all the wheels off the ground.

**If the vehicle is towed by other means or incorrectly, vehicle damage may occur.**

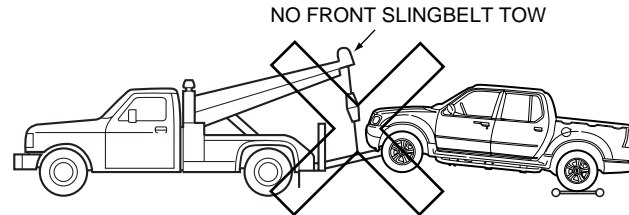
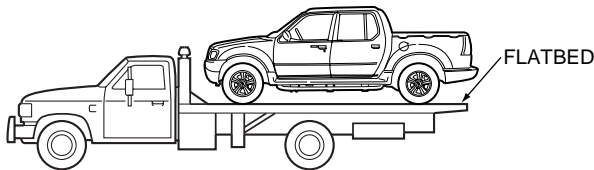
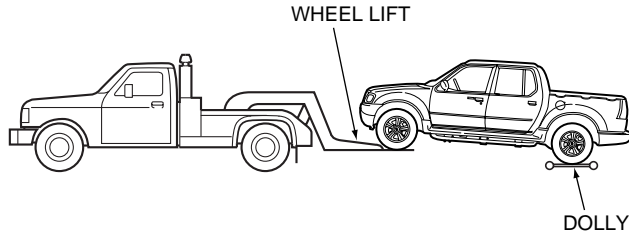

## SPORT, SPORT-TRAC (4x2) (4x4)

### REAR TOWING CONNECTIONS

**CAUTION: Do not tow with J-hooks under any circumstances. J-hooks will damage driveline and suspension components.**



**CAUTION: It is recommended that the Sport, Sport-Trac (4x2) (4x4) be towed with a wheel lift or flatbed equipment. Do not tow with a slingbelt. Ford Motor Company has not approved a slingbelt towing procedure.**

**NOTE:** Refer to general towing information on pages 22 through 24 before towing vehicle.

**NOTE:** On a 4x2 vehicle, it is acceptable to tow the vehicle with the front wheels on the ground (without dollies) and the rear wheels off the ground.

**NOTE:** On a 4x4 vehicle, it is recommended that the vehicle be towed with a wheel lift or flatbed equipment with all the wheels off the ground.

**If the vehicle is towed by other means or incorrectly, vehicle damage may occur.**

TRANS	MPH/KMH	MILES/KMS
AUTO	35/55	50/80
MANUAL	35/55	UNLTD

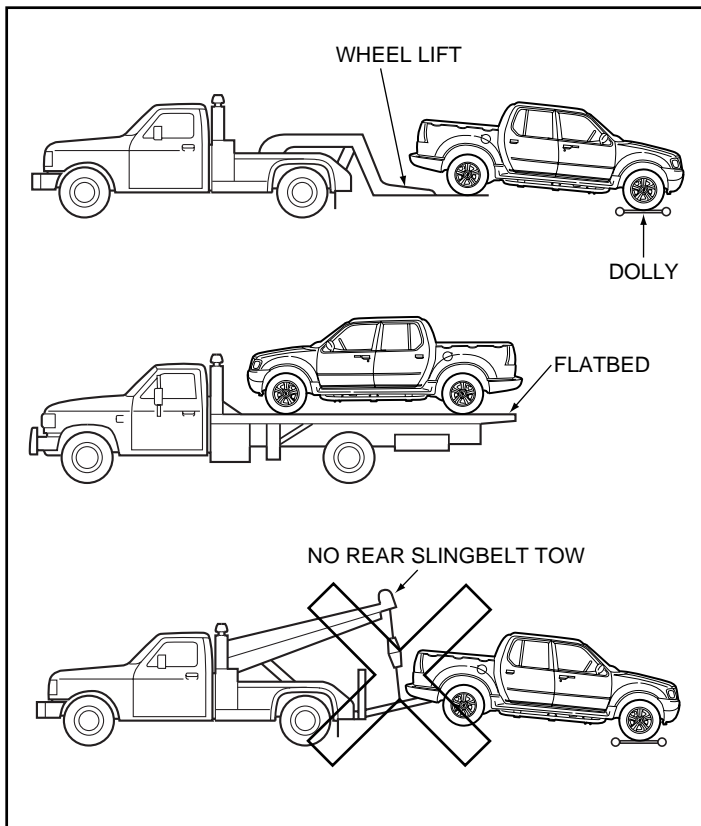





TRANS	MPH/KMH	MILES/KMS
AUTO	35/55	50/80
MANUAL	35/55	UNLTD

# RANGER

## FRONT TOWING CONNECTIONS

### DO NOT TOW WITH SLINGBELT EQUIPMENT

CAUTION: Do not tow with J-hooks under any circumstances. J-hooks will damage driveline and suspension components.



CAUTION: It is recommended that the Ranger be towed with a wheel lift or flatbed equipment. Do not tow with a slingbelt. Ford Motor Company has not approved a slingbelt towing procedure.

NOTE: Refer to general towing information on pages 22 through 24 before towing vehicle.

NOTE: On a 4x4 vehicle, it is recommended that the vehicle be towed with a wheel lift and dolly or flatbed equipment with all the wheels off the ground.

**If the vehicle is towed by other means or incorrectly, vehicle damage may occur.**

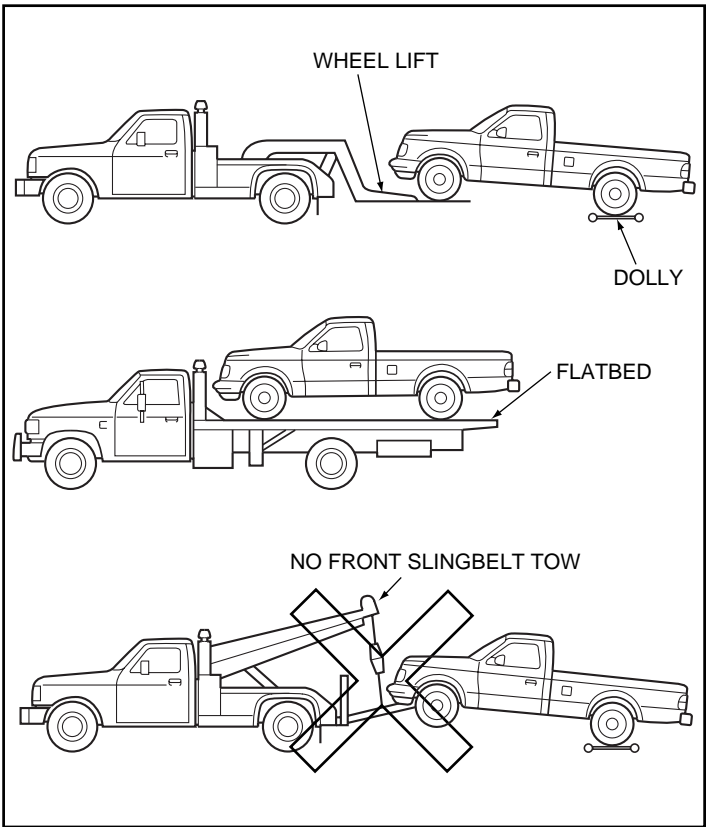

# RANGER

## REAR TOWING CONNECTIONS

### DO NOT TOW WITH SLINGBELT EQUIPMENT

**CAUTION:** It is recommended that the Ranger be towed with a wheel lift or flatbed equipment. Do not tow with a slingbelt. Ford Motor Company has not approved a slingbelt towing procedure.

**NOTE:** Refer to general towing information on pages 22 through 24 before towing vehicle.

**NOTE:** On a 4x2 vehicle, it is acceptable to tow the vehicle with the front wheels on the ground and the rear wheels off the ground.

**NOTE:** On a 4x4 vehicle, it is recommended that the vehicle be towed with a wheel lift and dolly or flatbed equipment with all the wheels off the ground.

**If the vehicle is towed by other means or incorrectly, vehicle damage may occur.**

TRANS	MPH/KMH	MILES/KMS
AUTO	35/55	50/80
MANUAL	35/55	UNLTD

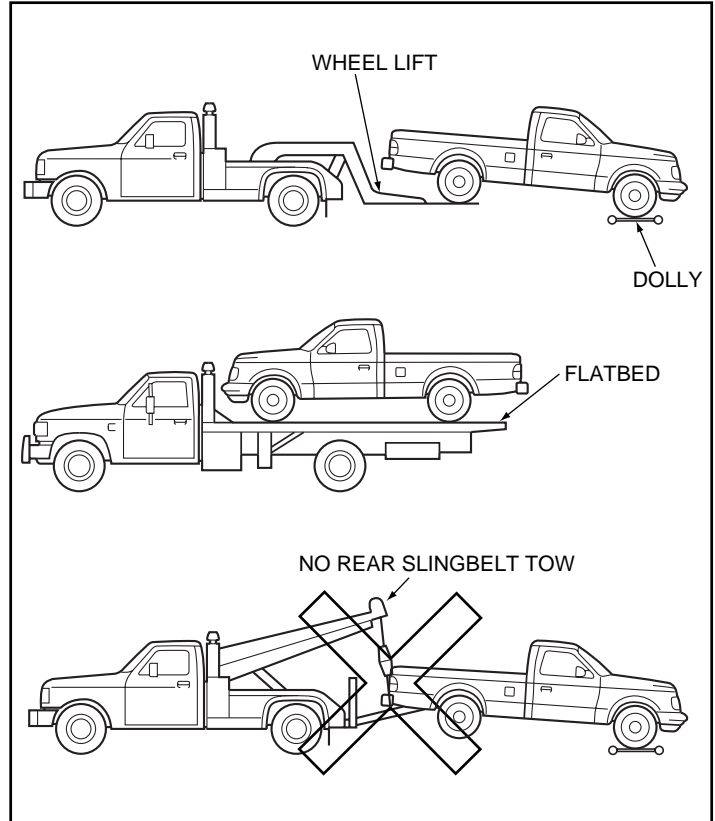



TRANS	MPH/KMH	MILES/KMS
*	35/55 55/90	50/80 UNLTD
**	35/55 55/90	50/80 UNLTD

\*2WD & 4WD Electronic Shift Transfer Case

\*\*4WD Lever Operated Transfer Case

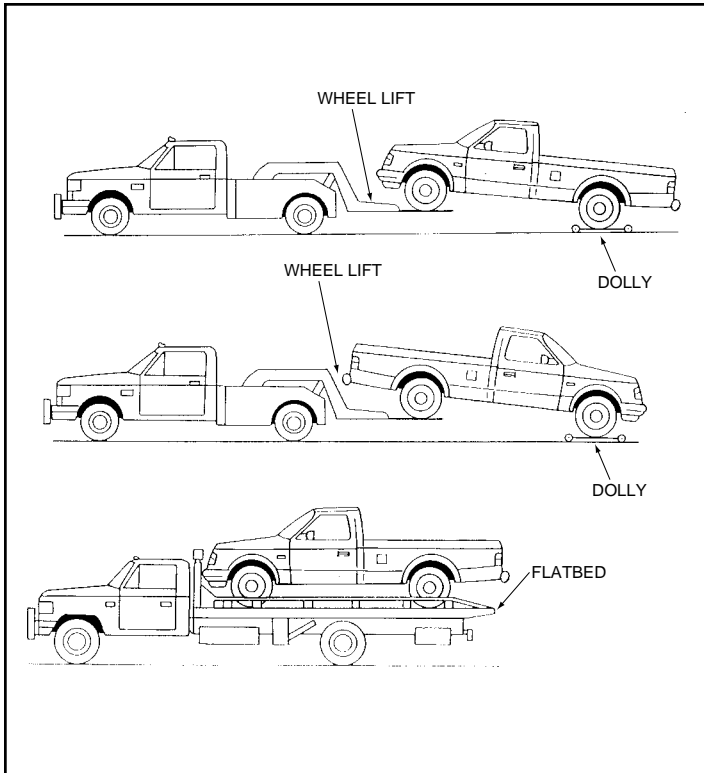

F-150, SVT LIGHTNING, HARLEY DAVIDSON SUPERCREW,  
NAVIGATOR, EXPEDITION, BLACKWOOD

## FRONT AND REAR TOWING CONNECTIONS

### DO NOT TOW WITH SLINGBELT EQUIPMENT

**CAUTION:** It is recommended that the vehicle be towed with a wheel lift or flatbed equipment. Do not tow with a slingbelt. Ford Motor Company has not approved a slingbelt towing procedure.

**CAUTION:** If the vehicle is equipped with air suspension, the air suspension control must be turned to the OFF position. For Expedition and Navigator, the air suspension shut-off switch is located behind an access panel on the left rear quarter trim panel, near the liftgate. For all other vehicles, the control is located behind an access panel beneath the passenger side of the instrument panel.

**NOTE:** Refer to general towing information on pages 22 through 24 before towing vehicle.

**NOTE:** On a 4x2 vehicle, it is acceptable to tow the vehicle with the front wheels on the ground (without dollies) and the rear wheels off the ground.

**NOTE:** On a 4x4 vehicle, it is recommended that the vehicle be towed with a wheel lift and dolly or flatbed equipment with all the wheels off the ground.

**If the vehicle is towed by other means or incorrectly, vehicle damage may occur.**

## F-250, F-350, F-450, F-550 SUPER DUTY (4x2) (4x4)

### FRONT TOWING CONNECTIONS

**CAUTION:** When towing F-Series vehicles, a 4x4 crossbeam should be used with 4x4 models, but should not be used with 4x2 models, to avoid potential damage to the lower radiator support and oil cooler lines.

**NOTE:** Refer to general towing information on pages 22 through 24 before towing vehicle.

- Insert T-hooks in T-hook slots in frame.
- Position 4x4 crossbeam under each leaf spring, supported at the tow chains and sling tow bar.
- Attach safety chains around axle.

**NOTE:** Some F-450 and F-550 vehicles may include or be equipped with aftermarket equipment. These components could be damaged using a slingbelt or wheel lift. Refer to the body builders information for towing instructions.

**NOTE:** On a 4x4 vehicle, it is recommended that the vehicle be towed with a wheel lift and dolly or flatbed equipment with all the wheels off the ground.

**If the vehicle is towed by other means or incorrectly, vehicle damage may occur.**

TRANS	MPH/KMH	MILES/KMS
AUTO	UNLTD	UNLTD
MANUAL	UNLTD	UNLTD

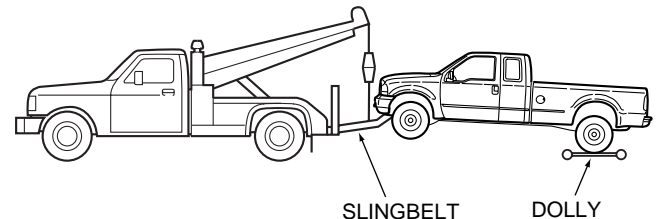
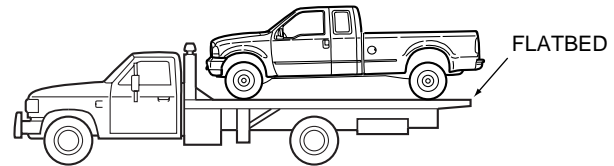
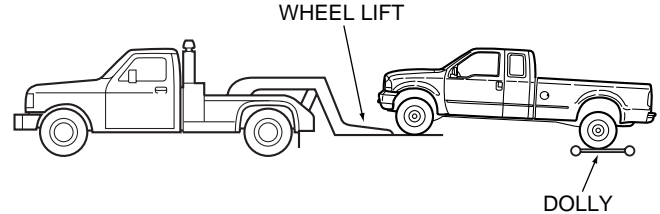



TRANS	MPH/KMH	MILES/KMS
AUTO	UNLTD	UNLTD
MANUAL	UNLTD	UNLTD

## F-250, F-350, F-450, F-550 SUPER DUTY (4x2) (4x4)

### REAR TOWING CONNECTIONS

NOTE: Refer to general towing information on pages 22 through 24 before towing vehicle.

- Attach T-hooks in T-hook slots on frame rail.
- Locate the slingbelt under the rear bumper.
- Attach safety chain around rear axle.

NOTE: Some F-450 and F-550 vehicles may include or be equipped with aftermarket equipment. These components could be damaged using a slingbelt or wheel lift. Refer to the body builder information for towing instructions.

NOTE: On a 4x2 vehicle, it is acceptable to tow the vehicle with the front wheels on the ground (without dollies) and the rear wheels off the ground.

NOTE: On a 4x4 vehicle, it is recommended that the vehicle be towed with a wheel lift and dolly or flatbed equipment with all the wheels off the ground.

**If the vehicle is towed by other means or incorrectly, vehicle damage may occur.**

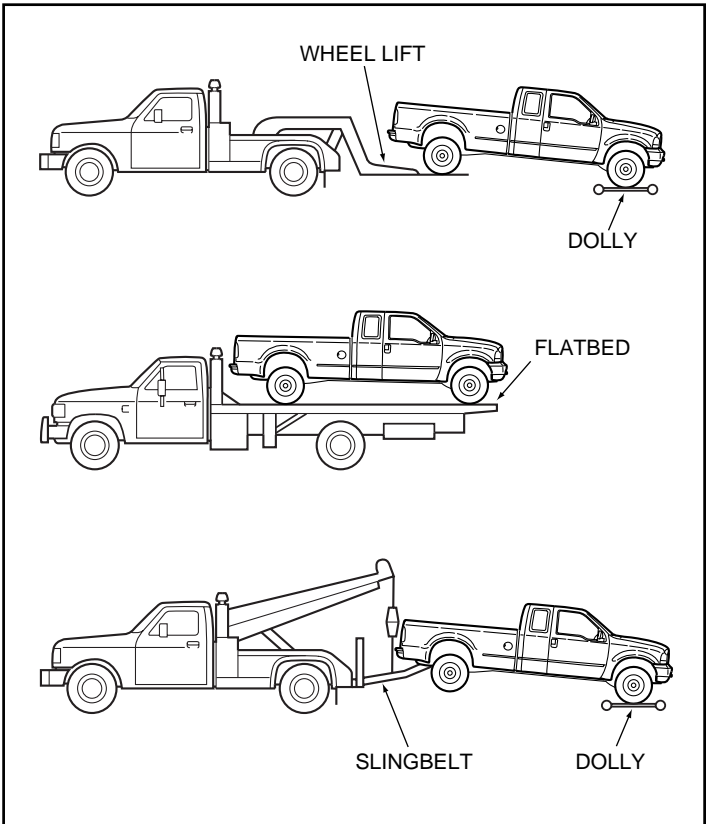

## EXCURSION (4x2) (4x4)

### FRONT TOWING CONNECTIONS

**CAUTION:** When towing the Excursion, a 4x4 crossbeam should be used with 4x4 models, but should not be used with 4x2 models, to avoid potential damage to the lower radiator support and oil cooler lines.

**NOTE:** Refer to general towing information on pages 22 through 24 before towing vehicle.

- Insert T-hooks in T-hook slots in blocker beam or front spring hanger brackets.
- Attach safety chain around axle.

**NOTE:** On 4x4 vehicles it is recommended that the vehicle be towed with a wheel lift and dolly or flatbed equipment with all the wheels off the ground. However, a slingbelt with T-hooks and a dolly can be used.

**If the vehicle is towed by other means or incorrectly, vehicle damage may occur.**

TRANS	MPH/KMH	MILES/KMS
AUTO	UNLTD	UNLTD

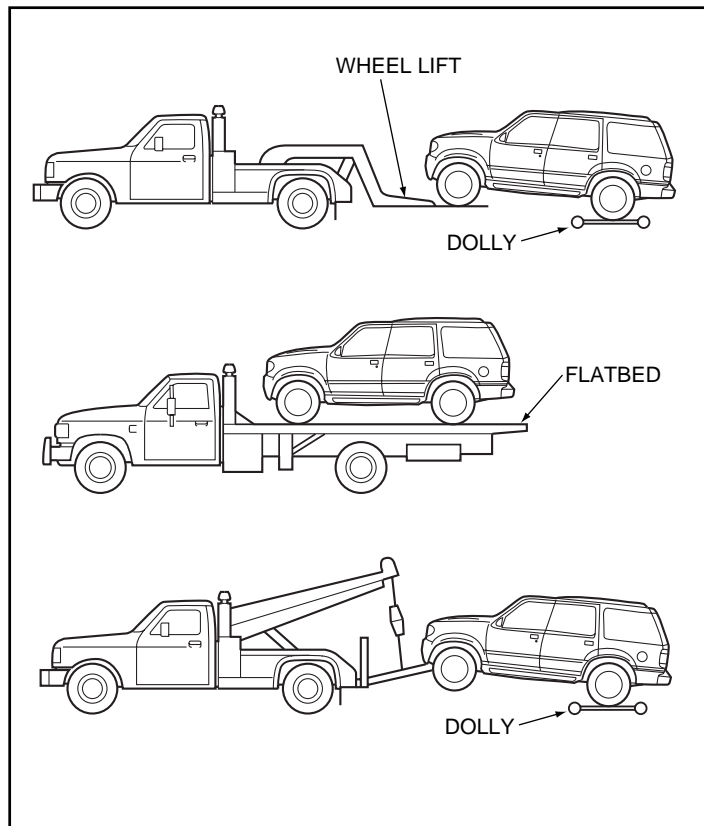



TRANS	MPH/KMH	MILES/KMS
AUTO	UNLTD	UNLTD

## EXCURSION (4x2) (4x4)

### REAR TOWING CONNECTIONS

**NOTE:** Refer to general towing information on pages 22 through 24 before towing vehicle.

- Attach T-hooks in T-hook slots on frame rail or frame mounted trailer hitch.
- Locate the slingbelt under the rear bumper or frame mounted trailer hitch.
- Attach safety chain around rear axle.

**NOTE:** On a 4x2 vehicle, it is acceptable to tow the vehicle with the front wheels on the ground (without dollies) and the rear wheels off the ground using a wheel lift or a slingbelt with T-hook.

**NOTE:** On a 4x4 vehicle, it is recommended that the vehicle be towed with a wheel lift and dolly or flatbed equipment with all the wheels off the ground. However, a slingbelt with T-hooks and dolly can be used.

**If the vehicle is towed by other means or incorrectly, vehicle damage may occur.**

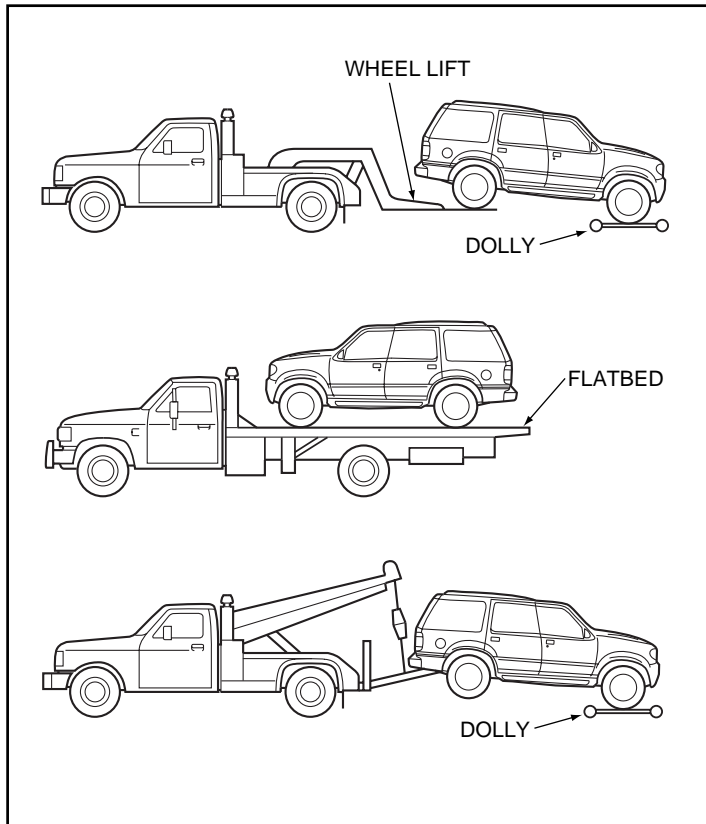

# ESCAPE

## FRONT TOWING CONNECTIONS

**CAUTION: Do not tow with J-hooks under any circumstances. J-hooks will damage driveline and suspension components.**



**CAUTION: It is recommended that the Escape be towed with a wheel lift or flatbed equipment. Do not tow with a slingbelt. Ford Motor Company has not approved a slingbelt towing procedure. If the vehicle is towed by other means or incorrectly, vehicle damage may occur.**

**NOTE: On a 4x2 vehicle, it is acceptable to tow the vehicle with the rear wheels on the ground and the front wheels off the ground.**

**NOTE: On a 4x4 vehicle, it is recommended that the vehicle be towed with a wheel lift and dolly or flatbed equipment with all the wheels off the ground.**

**NOTE: Refer to general towing information on pages 22 through 24 before towing vehicle.**

TRANS	MPH/KMH	MILES/KMS
AUTO	UNLTD	UNLTD

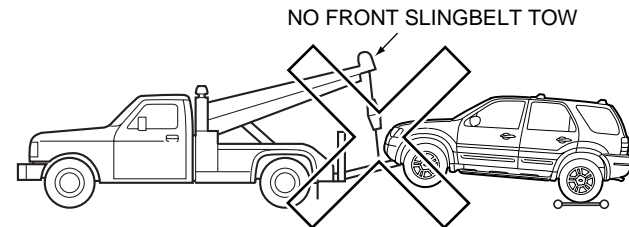
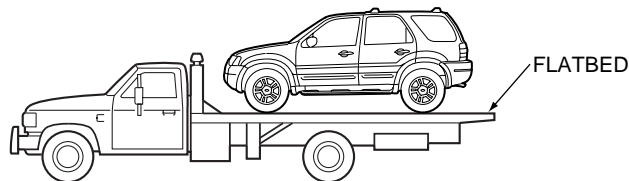
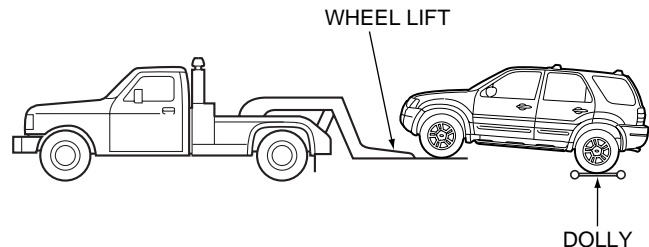





TRANS	MPH/KMH	MILES/KMS
AUTO	UNLTD	UNLTD

# ESCAPE

## REAR TOWING CONNECTIONS

**CAUTION:** Do not tow with J-hooks under any circumstances. J-hooks will damage driveline and suspension components. 

**CAUTION:** If the Escape is to be towed from the rear using wheel lift equipment, the front wheels (drive wheels) must be placed on a dolly to prevent damage to the transaxle.

**CAUTION:** It is recommended that the Escape be towed with a wheel lift or flatbed equipment. Do not tow with a slingbelt. Ford Motor Company has not approved a slingbelt towing procedure. If the vehicle is towed by other means or incorrectly, vehicle damage may occur.

**NOTE:** Refer to general towing information on pages 22 through 24 before towing vehicle.

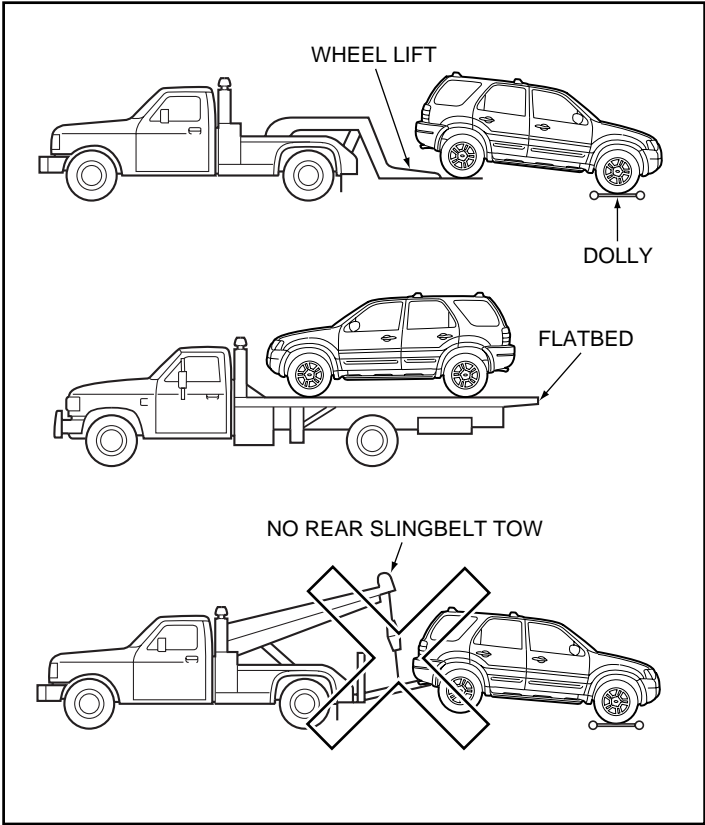

**E-SERIES, CLUB WAGON, E-150, E-250, E-350, E-450, E-SPORT**

TRANS	MPH/KMH	MILES/KMS
AUTO	35/55	50/80

2WD

## FRONT TOWING CONNECTIONS — SLINGBELT

**CAUTION:** If the vehicle is equipped with an air dam and must be towed from the front, it is recommended that the vehicle be towed with a wheel lift or flatbed equipment to prevent damage to the air dam.

**CAUTION:** It is recommended that the E-Series vehicles be towed with a wheel lift or flatbed equipment. However, a slingbelt with T-hooks can also be used.

**CAUTION:** When towing E-Series vehicles, spacer blocks must be used with a 4x4 crossbeam.

**NOTE:** Refer to general towing information on pages 22 through 24 before towing vehicle.

- Insert T-hooks in horizontal T-hook slots in frame.
- Place spacer blocks and 4x4 crossbeam behind bumper and air dam and across frame rails. Make sure that spacer blocks are under frame rails.
- Attach safety chains around axle, outboard of coil springs.

**If the vehicle is towed by other means or incorrectly, vehicle damage may occur.**

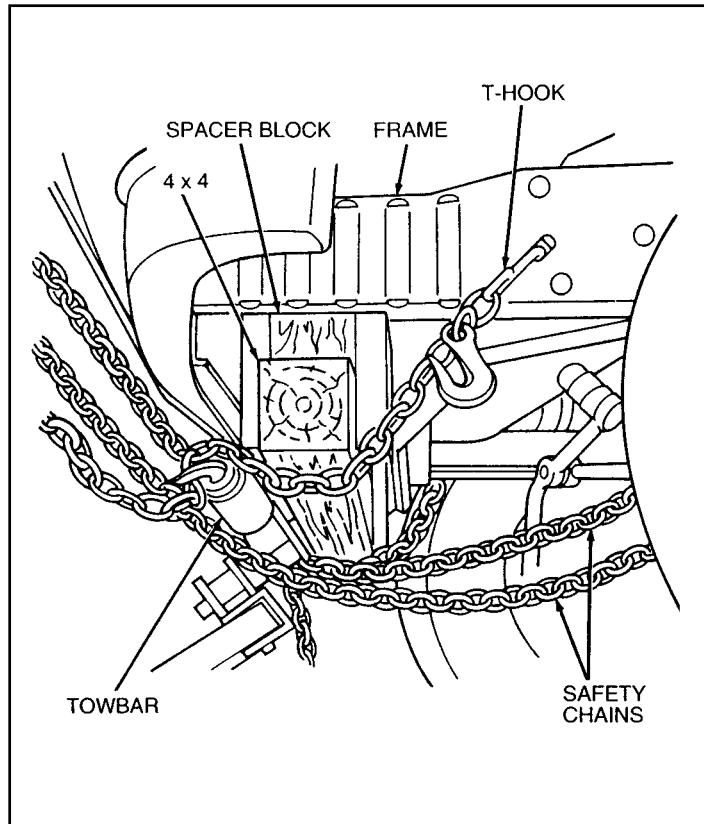



TRANS	MPH/KMH	MILES/KMS
AUTO	UNLTD	UNLTD

**E-SERIES, CLUB WAGON, E-150, E-250, E-350, E-450, E-SPORT**

**REAR TOWING CONNECTIONS**

**CAUTION:** It is recommended that E-Series vehicles be towed with a wheel lift or flatbed equipment. However, a slingbelt with T-hooks can also be used.

**NOTE:** Refer to general towing information on pages 22 through 24 before towing vehicle.

- Attach T-hooks in T-hook slots on frame rail, inside the leaf spring.
- Route chains below spring shackles, on the right side route chain above tail pipe.
- Place towbar under rear bumper, missing spare tire.
- Attach safety chain around rear axle. Route chain between axle and parking brake cable on RH side.

**If the vehicle is towed by other means or incorrectly, vehicle damage may occur.**

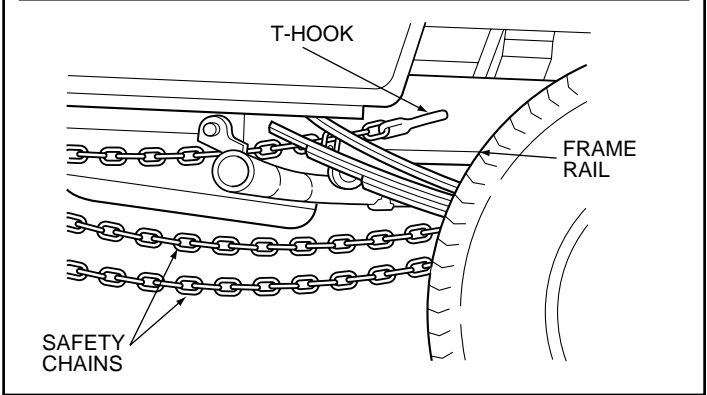
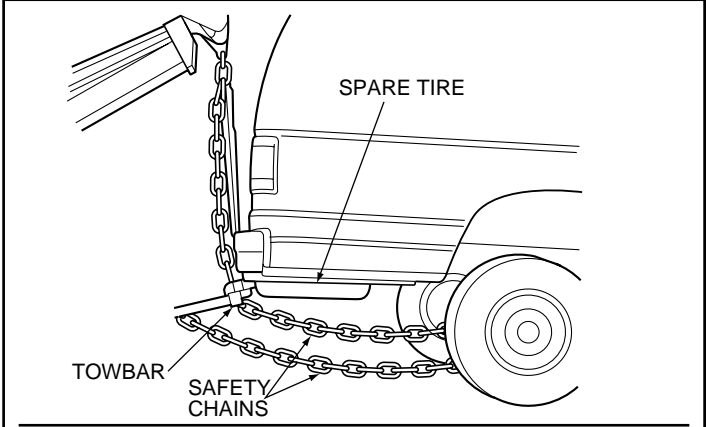

## **2003 FORD SERVICE INFORMATION**

With our 2003 Service Information, you can repair Ford, Lincoln and Mercury Cars and Light Trucks in an expert manner and ensure customer satisfaction. The low cost of this information is an investment in the growth of your business.

### **WORKSHOP MANUALS**

Now available on DVD-ROM, Workshop Manuals provide complete maintenance and repair procedures. Both Car and Truck Workshop Manuals cover Body, Chassis, Electrical, Powertrain, Pre-Delivery and Emissions. A “must” to do the job right the first time.

### **WIRING DIAGRAMS**

Provide schematics of all electrical components and identifies each wire to its proper function.

### **PUBLICATIONS ORDERING INFORMATION**

To obtain information about ordering additional copies of this publication or to order any other Ford or Lincoln/Mercury publication write to : Ford Publications, care of Helm Inc., P.O. Box 07150, Detroit, MI 48207.